



Plymouth Observer

VOLUME 107 NUMBER 24

MONDAY, NOVEMBER 23, 1992 • PLYMOUTH, MICHIGAN • 40 PAGES

FIFTY CENTS

© 1992 Suburban Communications Corporation

IN THE PAPER

TODAY

Thanksgiving: A festival started last year in Plymouth to celebrate Thanksgiving is becoming an annual affair. The event returns Friday and gives folks a look at how things were during the first Thanksgiving. /3A

STREET SCENE



Coming home: What do you do if your highly anticipated New York showcase draws an audience of seven? If you're the Vudu Hippies, you head home and get back to the basics that clicked in the first place. /4A

TASTE

Panic time: Don't sweat Thanksgiving. Help is only a hot line call away. We've got a list of hot lines you can call, even on Thanksgiving, tips for thawing, and cooking the big bird. /1B

Winner Dinner: Don't cry fowl the day after Thanksgiving. This week's Winner Dinner features an appetizing dish made with turkey and stuffing leftovers. A cranberry gelatin salad completes the meal. /1B

SPORTS

District final: Plymouth Salem attempted to win a district championship in girls basketball Friday. /1C

Grid playoff: Catholic Central played a Class AA semifinal football game Saturday in hopes of reaching the state final again. /1C

INDEX

Obituaries . . . 2A Taste . . . 1B
Sports . . . 1C Malls . . . 5B
Street Scene . . . 4A

OUR PHONE NUMBERS

Newsroom: 459-2700
Newsroom Fax: 459-4224
Sports: 953-2104
Reader Comment Line: 953-2042
Classified Advertising: 591-0900
Display Advertising: 591-2300
Home Delivery: 591-0500
Cable/TV Weekly: 478-5160

\$1.44 million awarded in lawsuit



A settlement has been reached in a lawsuit filed in the wake of a two-plane collision over Plymouth Township that killed three persons. One of the planes had taken off from Mettetal Airport in Canton.

BY KEVIN BROWN
STAFF WRITER

A lawsuit sparked by a small plane collision in 1990 over Plymouth Township has resulted in a \$1.44 million jury award for the family of one crash victim.

A Wayne county circuit court jury on Nov. 12 ruled in favor of the family

of Robert Gunn.

The suit followed the July 23 collision of the plane occupied by Gunn, 65, and Charles Nix, 55, of Detroit, with a second airplane piloted by Daniel Starr of Cedar Springs. All three men died in the crash.

Roger Wolcott, who represented Gunn's family, said the jury agreed

with a National Transportation Safety Board finding that the Federal Armed Services Inc. airplane piloted by Starr violated federal regulations by overtaking the aircraft occupied by Gunn and Nix.

In the suit, Wolcott claimed negligence on the part of Federal Armed Services.

Scott Torpey, attorney for Federal Armed Services, said he would file an appeal before the state Court of Appeals "within the next month or two."

"The jury deliberated for four days,

it was obviously a close decision," he said.

While the main wreckage of each airplane was separated by several hundred yards, debris was scattered over a two-mile area.

The collision happened at 9:30 a.m. on a cloudless day just south of M-14 and west of Beck.

According to the NTSB, the crash happened when Starr, in a twin-engine Piper Aerostar, tried to overtake the single-engine Piper Cherokee flown by Nix.

See LAWSUIT, 8A

City expands recycling

BY KEVIN BROWN
STAFF WRITER

City residents will soon be able to put out more kinds of recyclables at the curb.

Magazines, batteries, corrugated cardboard, envelopes (junk mail) and glass are to be accepted at the curb along with items already being taken.

CURBSIDE

This is the first significant change in the city's curb-side recycling program since it began in July.

The start-up of the expanded program "will be in the near future," said assistant city manager Paul Sincoc, "probably after the first of the year."

Sincoc and city solid waste coordinator Joe Russell said they're waiting for the go-ahead from the city's trash hauler, Mr. Rubbish.

It was earlier this year that city officials decided to go with a bagged-recyclables system, rather than the bin method used by Plymouth Township and other communities.

The creation of community recycling programs was sparked by orders from the state Department of Natural Resources to reduce trash going to landfills, or face penalties.

Since the city of Plymouth started its program, officials have had to field some complaints from residents wondering why the city didn't go for the bin method.

The recyclables-in-a-bag method the city opted for didn't include glass, as does the bin method. But once the revised program starts, glass will be accepted at the curb — not in the bag but in a separate container — along with other materials not being accepted in the communities using the bin method.

See RECYCLING, 8A



STAFF PHOTOS BY SHARON LEMIEUX

Hard work: Starr Stennis, daughter of Bob and Carole Boyer of Boyer's Meat Processing, likes the family business. In the heart of hunting season the family is putting in 15-hour days getting deer processed for hunters.

Oh deer: Slaughterhouse is busy

BY JOANNE MALISZEWSKI
STAFF WRITER

For the faint-hearted, the buzz of the saw can be deafening. Not to mention the sight of a deer's hind quarter whizzed through the sharp blade. But for the Boyer family, it's another day on the job.

"It's a family business," said Starr Stennis, daughter of Bob and Carole Boyer, who operates Boyer's Meat Processing. "I do everything my dad does — except the saw."

In the heart of the hunting season, the Boyer family is consumed with deer — dead deer. The bow season brought the Boyers 232 deer for processing. And by the time hunting is over the family expects to process close to 1,000 deer.

"We're running pretty close to even (with last year)," Bob Boyer

said. As of Thursday morning, the family had worked on its 245th deer.

Except for a sign posted at the end of a driveway, you wouldn't notice the operation as you drove down Barr Road off of Geddes in the far southwest corner of the township. A nice house faces the roadway. A long driveway takes you back to the processing plant surrounded by fenced areas.

What is everyday for the Boyers might not be for the average person who would rather not know what happens to the cows, pigs, goats and lambs that sooner or later become dinner. The Boyers smile a lot when a newcomer walks in apprehensively. But a handshake can

See SLAUGHTERHOUSE, 2A



STAFF PHOTOS BY SHARON LEMIEUX

Deer days: Larry Boyer has his work cut out for him this hunting season. By the end of the season he expects to skin close to 1,000 deer.

Local crowd hears 'thumbs up' message

BY M.B. DILLON
STAFF WRITER

Mike Utley, the Detroit Lion paralyzed in a game at the Silverdome a year ago, won the hearts of hundreds as he addressed a standing-room-only crowd of kids, teachers, parents, and reporters at West Middle School Thursday. Among them was an NBC TV crew filming a segment for a special to be aired nationally before the Lions' Thanksgiving Day game. Seventh-grader Chad Ellege spoke

for many when he said, "Mike Utley is like a cool guy and everything. He has a good attitude."

Utley, a right guard, broke his neck in a freak play in the Lions-Rams game a year ago Nov. 17. As he was carried from the field on a stretcher, Utley flashed the "thumbs up" sign to teammates and fans, signaling that he'd be back.

The gesture sums up the goal of the Mike Utley Foundation for spinal cord injury research, as well as the

National Football League's Thumbs Up merchandise program that benefits the foundation.

The Livonia-based Wauldron Corp., brainchild of Plymouth resident Jim Wauldron, recently received an NFL license to sell Thumbs Up T-shirts, sweatshirts and caps with the logos of all 28 NFL teams. So far, the NFL has donated \$150,000 in royalties from merchandise sales to the foundation.

Local kids

At West, Utley spent an hour kibitzing with his host and friend Jim Wauldron, answering students' questions, and relating what he's learned about life.

Thumbs up posters and banners welcoming Utley hung on walls throughout the school. One thumbs up poster, covered with students' signatures, was given to Utley along with

See UTLEY, 8A

Mayor's appointment

Dennis Nisch has been appointed by Mayor Robert Jones to fill a vacant seat on the downtown development authority.

The appointment was made Nov. 16. Nisch fills the vacancy created by the resignation of Stella Greene, recently appointed to the city commission.

Santa train

Santa will be aboard the CSX Santa Train from 1-6 p.m. Saturday, Dec. 5, at the tracks at Main Street across from Bode's Restaurant.

He's looking forward to seeing all kids young and old. Santa's appearance is sponsored by the

PLYMOUTH PIPELINE

CSX Detroit District Safety Team and the Detroit & Plymouth Operation Red Block Team.

Ark shows

The Ark in Ann Arbor, which showcases top acoustic music performers, features Irish singer Maura O'Connell in two shows Tuesday, Dec. 1.

Tickets are \$12.50 for the 7:30 and 9:30 p.m. shows. O'Connell's repertoire includes traditional and contemporary material from Ireland and jazz, Southern gospel and pop.

She sings in a "once-in-a-lifetime voice, an ex-

quisitely rich instrument that rises from the warm whispers within to high, belted declarations full of swooning vibrato," according to an Ark announcement.

The Ark features its Open Stage at 8 p.m. Wednesday, Dec. 2. Sign up at 7:30 p.m. for a short set.

For more information on Ark shows, call 761-1800.

Raffle winner

John Seelow of Plymouth won the \$300 first prize in a raffle to raise money for a transportable dance floor for the Michigan Classic Ballet.

The drawing was Halloween. The grand total raised through raffle ticket sales was \$2,892 for the non-profit arts corporation.

Speaker: decide who can be helped

BY JOANNE MALISZEWSKI
STAFF WRITER

There's a better way. "The reality down the road is that none of us will have enough money to help everyone," said Myron Liner, vice president of United Way of Southeast Michigan.



Myron Liner

Liner, whose job it is to determine which agencies receive United Way funding, told the Canton Economic Club at Geneva Presbyterian Church Wednesday that there is a better way — particularly with reductions in human resources funding — to determine who will be helped.

"All of the money we spend will not solve problems and make them go away." And it's a myth that volunteers can pick up the slack of what government and social service agencies cannot provide, Liner said.

Northwestern University has developed a method of filling the gap of "where people are and where they need to be," Liner said.

Community mapping, such as going door-to-door to determine needs, must be done. Liner suggested providing services based on a system similar to medical triage where it's determined who

can wait for help, who needs help immediately and who really can't be helped.

"It makes better use of existing services," Liner said. "To put a Band-Aid on problems probably makes us feel better in the short run," but people will be back for help.

Liner is expected to send information to Canton about such a community study. "I understand the concept, not necessarily the

process," said the Rev. Bill Myers, a past president of the Canton Community Foundation.

Township supervisor Tom Yack expressed the same sentiments. Yack would like people with time and talents to join forces with those who need help. "I'd like a community volunteer center established. I think we understand the potential in the community."

The need to recognize that as on a battlefield not all people can be helped, made sense to Myers and others.

"That for me was the most hopeful thing to say," Myers said. "Before it was not hopeful because there are more people and problems than dollars. For me, this was a logical way to get the most bang for the buck."

Rather than just a door-to-door approach to determine who needs what, Myers suggested that the school system, law enforcement and churches, for example, also be included in any survey.

Bill Joyner, foundation executive director, said it's time to adapt to different ways. "I think Myron Liner's suggestion is one we need to consider and perhaps implement."

Joyner lauded Liner's assessment of Canton as a healthy community in which commitment to others is clear. The formation of the foundation shows a recognition of problems in the community. "There does exist a basic infrastructure of services."

Services need to be unique and provided in a unique way to match the community. "We need to adapt to changing strategies," he said. "We are in constant communication with people; with homeowners associations, with students. The best way is to be streetwise and be out in the streets."

Bruce Patterson, foundation vice president, was intrigued with Liner's comments. "Our foundation is awkward and gawky and is reactive instead of proactive. We are at a point in our civilization where we can't expect never-ending resources for never-ending problems."

Patterson said he is hopeful for new ways of meeting needs with continuing limited dollars. "We are progressing toward a time when we will be able to delineate the community and its needs."

Tape deck stolen

CRIME WATCH

An employee from Tyme Auto Sales reported that sometime between Nov. 14-16, someone removed an AM-FM stereo cassette from the dash of a 1985 Jeep wagon parked on his used car lot.

The value is estimated at \$102. The complainant has no suspects.

Rubber check

A Northville man told police that a customer's \$1,500 check, submitted Oct. 19 for auto parts, was returned marked non-sufficient funds.

The suspect, 35-year-old

from Sterling Heights, was reached by phone and told the complainant he didn't have any money.

It's believed the man's business may have gone under and that he possibly is residing with his mother.

The check was drawn on a First of America bank. The man had been a customer for six-to-eight months and had an open account.

The complainant wishes to prosecute.

OBITUARIES

HILDA A. ECKLES

Services for Hilda A. Eckles, 94, of Plymouth will be Tuesday, Nov. 24, at Ross B. Northrop Funeral Home in Northville. Burial will be at Riverside Cemetery.

She was born Sept. 27, 1898, in Plymouth. She died Monday, Nov. 16, in Livonia. The family home in which she was born still stands on Forest Avenue. She lived her entire life in the area. She worked at Daisy Air Rifle for many years and in the later years worked at Minerva-Dunnings, yard goods department, on Forest Avenue. She retired in 1983.

She is survived by two daughters-in-law, Salley Eckles of Plymouth and Ethel Eckles of Plymouth; seven grandchildren; 12 great-grandchildren and two great-great-grandchildren.

The Rev. Dr. Frederick C. Vosburg of First United Methodist Church of Plymouth officiated

the service. Memorial contributions may be given to a charity of choice.

RICHARD H. VAUGHN

Services for Richard H. Vaughn, 65, of Plymouth were Wednesday, Nov. 18, at Schrader Funeral Home.

He was born June 30, 1927, in Detroit. He died Sunday, Nov. 15, in Plymouth. He came to the Plymouth community in 1958 from Livonia. He was self employed as a power washer before he retired.

He is survived by his wife, Shirley Vaughn of Plymouth; one daughter, Carol Tromotola of Plymouth; one son, Richard Vaughn of Canton; and four grandchildren.

The Rev. William A. Myers Jr. officiated the service. Memorial contributions may be given to a charity of choice.

Slaughterhouse from page 1A

put the newcomer at ease.

Helping hunters

"The hunters bring them in, drop them off and we take care of it from there," Stennis said.

From the average 100-pound deer, the Boyers — all dressed in white, including aprons and caps — make steaks, roasts, chops, hamburger and sausage. The cuts are packaged and quick frozen. Processing takes about three-four days and costs about \$35. Actually, the Boyers can make 14 different kinds of sausage.

"They (deer) should be brought in right away," Bob Boyer said. "You cannot age venison."

The work starts in a smaller room where Boyer's son, Larry, hangs the deer up and skins it. The animals are already gutted by hunters right after they are killed. "The hunter has to gut them otherwise the meat will spoil. They leave it (internal organs) in the woods for other animals to eat," Bob Boyer said.

Unless the hunter wants it, skins will be sent to a hide company. The feet or hoofs this

year will be given to area Boy Scouts for a project. Nothing really has to go to waste. Heads this year are expected to be picked up by a woman involved in another project, Boyer said.

When Larry Boyer is done, the deer is sent into the next room — sort of the main room — where Bob Boyer is working the saw, and his wife, Carole, and daughter, Starr, package the meat.

With hunting season in full swing, the Boyers are a busy family. Fifteen-hour days are the norm. But as Starr says, it's a good job working with her family and setting her own hours. What more could you ask?

Bob Boyer can rattle off the answers to any variety of questions about meat, its taste and how it's best processed. Does are better meat. Venison has a wild taste. And bear meat — the Boyers process maybe five or six annually — has a strong taste.

Michigan deer aren't the only type processed by the Boyers. Hunters bring in deer from Pennsylvania and Wyoming. And they also process antelope, caribou and moose.

But that's not all the Boyers do. They also raise animals for slaughter. "We don't retail

anything," Carole Boyer said. In fact, you can drive down there, pick out an animal and tell them how you want it processed. A whole cow, for example, costs \$1,000-\$1,100.

Farm animals

Other customers bring their farm animals in to be slaughtered. "If you're a farmer you bring it in to us. You know what that animal has eaten. When you buy at the store, you don't know what the animals have been fed," Bob Boyer said.

All cuts are to the customer's liking. That's appealing to many who follow certain religious practices. Boyer sells a lot to Middle Eastern customers, for example.

There's no doubt the Boyers know what they're doing. They've had the processing plant on Barr Road for eight years. Before that, Carole and Bob owned their own grocery store with a butcher's shop for 16 years. Before that, Bob was a butcher for the Kroger supermarket chain.

Next year, the family expects to add some new equipment so they can process poultry including ducks, geese, chickens and turkeys.

Elizabeth's Bridal Manor
AND TUXEDO RENTALS

SAMPLE SALE 25% - 70% OFF

While quantities last; size 10 from these prestigious manufacturers:

Jim Hjelin,
Eve of Milady,
Galina, Illissa,
Jenna Couture,
...
tomorrow's heirlooms

402 S. Main, Northville (313) 348-2783

Elizabeth Clancy Alan Brown
Hours: Mon-Thur. 11-9 • Fri. 11-6 • Sat. 10-6 • Sun. 12-5

Holiday Parties
at
BRAE BURN GOLF CLUB
"Home of The Monster"

We Offer...

- Cozy Fireplace Setting
- Golf Course View
- Room for up to 150 People

Call Now For More Information About Our Party Packages
...And To Reserve Your Party!

BRAE BURN GOLF CLUB
10860 W. 5 Mile Road • Plymouth • 2 Miles W. of Beck Road
6 Minutes from I-96 & I-275 INTERCHANGE
(313) 453-1900

Silverman's **1/2 OFF**
459-2066 24 HOURS

Main St. at Ann Arbor Rd • PLYMOUTH

BUY ONE ENTREE-GET 2nd ENTREE 1/2 OFF
(of equal or lesser value - not good with any other offer)

Valid 3-11 PM • Excludes All-You-Can-Eat • Expires 11-30-92

HOMEMADE SPECIALS!

Mon. Meatballs & Mostaccioli
Tues. Chicken Pot Pie
Wed. Yankee Pot Roast
Thurs. Roast Pork Loin
Fri. Roast Sirloin of Beef
Sat./Sun. REAL Turkey Dinners

LET US CATER
YOUR NEXT MEETING, COMPANY
AFFAIR OR FAMILY GATHERING

10% OFF
Offer Expires 12-31-92

FOOTBALL SPECIAL
50% OFF
Broasted Chicken
Buckets To Go Only - Up to 7.00
Expires 11-30-92

Specials Served from 5 p.m.

Give Your Marble New Life

Both new and older marble needs professional care to look its best; and to maintain its value.

MARBLELIFE professionals use Union Carbide Marble Care technologies to restore marble, terrazzo and other dimensional stone and bring out its natural beauty, color and sheen; and provide a finish that is both lustrous and damage-resistant.

Call today for a free consultation.

459-6870

MARBLELIFE

Union Carbide Marble Corp.
Experts in Marble Restoration & Preservation.

Monthly Allergy Tip

**COLDS ...
COUGHS ...
SORE THROAT ...
BRONCHITIS ...
SINUSITIS ...**

These respiratory illnesses can happen to you at any time during the year. Time may be missed from work or school. These difficulties may be associated with allergies or asthma.

Call us. Let us help you that same day to feel better soon. We'll suggest the best treatment to get you back to your usual activities.

Don't suffer! See us and get the relief you need.

We participate with Blue Cross/Blue Shield, Medicare, Commercial Insurance, Selectcare, PPO, and most PPO's.

(313) 473-8440

ALLERGY AND ASTHMA CENTER OF SOUTHEAST MICHIGAN, P.C.
24230 Karim Blvd. (10 Mile Rd. West of Haggerty)
Suite 130, Novi, Michigan (easy access from I-275)

36 Hour Sale
MONDAY THRU WEDNESDAY ONLY!

9' American Fir SALE \$284.00

7' Smokey Mountain Hinged SALE \$149.00

7' Lewis Pine SALE \$159.00

6039-011 List Price \$189.00

save 20%
save 25%

Specialty selected values from our forest of everlasting life-like trees!

PLYMOUTH NURSERY
Christmas in the Country

453-5500

Christmas Hours:
Mon.-Fri. 9-8
Sat 9-6 Sun. 11-5

9900 Ann Arbor Rd.
Just 7 miles west of I-275

Offer Expires 11-25-92

Re-creation:
"A Plymouth Thanksgiving" highlight is the re-enactment of the first Thanksgiving dinner.



STAFF PHOTOS BY BILL BRESLER

Giving thanks

Holiday festival returns to city

BY KEVIN BROWN
STAFF WRITER

Plymouth's one-of-a-kind Thanksgiving celebration is ready to roll.

To go with the Thanksgiving re-enactment in Kellogg Park, the centerpiece of "A Plymouth Thanksgiving," are some new and improved features — a native American flute player, expanded storytelling and more.

The third annual event happens Friday and Saturday downtown.

Founded by downtown business people Fred Hill, Sharon Pugh and Nancy Sheehan, it's based on the idea that businesses start celebrating Christmas a bit too early, as some malls put out holiday decorations in October.

Plus, they say, Thanksgiving is a great American holiday, worthy of special attention.

Pugh said organizers have raised nearly \$7,000 to go with the \$3,000 kicked in by the city to put on the event.

"We had a few people who didn't contribute this year but we have some new people so it evens

out," she said.

Because the event has been a success with onlookers and with the press — the CNN network has reported on "A Plymouth Thanksgiving" worldwide — no big changes are in the works.

Returning are native American dancers, a non-denominational service, craft and art exhibitions in downtown shops, storytelling at the Masonic Temple near Kellogg Park and the main event — a re-creation of the first Thanksgiving with the Plymouth Park Players and native Americans in period dress.

Organizers are encouraging more community participation. "If anybody wants to dress up as pilgrims, join us, be a part of it," Pugh said.

Those interested can call the downtown development authority office, Plymouth Community Chamber of Commerce office, or her store, Sideways.

The event takes place from 10 a.m. to 6 p.m. both days.

Native American dancers are scheduled for noon and 2 p.m., the service for 1 p.m., the dinner

re-creation at 1:30 on Friday and Saturday.

The storytellers scheduled to perform are Ron Lowe, Plymouth's city attorney; Debra Christian and Charlotte Blair, at 3 p.m. both days.

On order are the corn stalks, Indian corn and other decorations traditionally used for "A Plymouth Thanksgiving."

Native American flute player Louie Thunderhawk is scheduled to play for 15 minutes at 11:30 a.m. and 2:45 p.m. both days.

Plans also call for the guitar-hammered dulcimer group the Deer St. Players to perform from 2-3 p.m. both days at the Mayflower Hotel, and from 3-4 p.m. at Kellogg Park both days if weather permits.

In the building that formerly housed Fred Hill Haberdashers on Main Street, there will be a chair-carving exhibition from 10 a.m. to 6 p.m. each day, in which the carver begins with a big slab of wood.

There is no charge to attend the "A Plymouth Thanksgiving" events.



BILL BRESLER/STAFF PHOTOGRAPHER

Pilgrim proud: "A Plymouth Thanksgiving" organizers Fred Hill and Sharon Pugh listen to a speech during last year's event.

Breaking bread: Native Americans join folks dressed as pilgrims at the Thanksgiving dinner re-enactment last year.



Fest events scheduled

Schedule of events for A Plymouth Thanksgiving is as follows:
■ Friday and Saturday at Kellogg Park:

11:30 a.m. — Louie Thunderhawk (Native American flute demonstration).

Noon — Native American dance demonstration.

1 p.m. — Thanksgiving service.

1:30 p.m. — First Thanksgiving re-enactment.

2 p.m. — Native American dance demonstration.

2:45 p.m. — Louis Thunderhawk (Native American flute demonstration).

3 p.m. — Dulcimer/guitar (Deer Street Players), weather permitting.

■ Friday and Saturday activities in other locations:

2 p.m. — Dulcimer/guitar (Deer Street Players), Mayflower Hotel lobby.

3 p.m. — Seasonal storytelling (Debra Christian, Ron Lowe, Charlotte Blair), Masonic Temple.

■ Indoor activities and demonstrations on Friday and Saturday:

Woodcarving, Engraving Connection, 930 W. Ann Arbor Road, 11 a.m.-4 p.m.

Bobbin lace making, Minerva's Dunning, 500 Forest, 1-3 p.m.

Teddy bear making, Muriel's Doll House, 824 Penniman, 11 a.m.-3 p.m.

Tatting and quilting, Village Decor, 825 Penniman, 10 a.m.-6 p.m.

Winson chair making (complete exhibit), Fred Hill Haberdasher

Building, 336 S. Main, 10 a.m. to 6 p.m.

Rug hooking, Folkways Trading Post, 838 Penniman, 10 a.m. to 6 p.m.

Quilting/lace making, Brass and Iron Beds, 873 W. Ann Arbor Trail, 11 a.m. to 5 p.m. Saturday only.

Weaving/sock knitting/spinning, Fireside Heritage Craters, Westchester Mall, 580 Forest, 11 a.m. to 6 p.m.

Stamp demonstration, Paper Parade, 19 Forest Place, 1-3 p.m. Friday only.

Traditional dancing (weather permitting), Curious Child, 11 Forest Place, 4-5 p.m. Friday only.

3 Cities art exhibition, Creative Framing, 858 W. Ann Arbor Trail, 9 a.m. to 9 p.m. Friday; 9 a.m. to 6 p.m. Saturday.

Cheer Club set for yule season full of joy of helping and giving

It's Thanksgiving week and Christmas is just around the corner.

That means shopping for friends and family. But when you're on those trips, don't forget the Plymouth and Canton Observer Newspaper Cheer Club.

The idea behind the club is that no child should be without a gift on Christmas, and no family should go hungry.

Joining is easy. Membership is open to anyone who can take the time to stop by our office at 744 Wing St., Plymouth, and drop off a canned good or new, unwrapped toy for a needy child.

We'll start taking donations the day after Thanksgiving.

Then, we'll continue to collect them through mid-December. That's when we'll turn them over to the Salvation Army for distribution to needy kids and families in our area.

So once Thanksgiving is out of the way, grab a

canned good or gift and come on by our office at 744 Wing. Bring the kids.

And we'd like to take your name and list it in The Observer with others who give to the Christmas Cheer Club.

Last year, we counted just over 200 donors coming into our office.

Meanwhile, the Plymouth Salvation Army announces they're aggressively seeking businesses, organizations, churches and schools to collect food for the needy.

Each year, the Plymouth Salvation Army gives thousands of food bags to needy families in Canton, Plymouth and Northville.

If your group is willing to display a "Baskets Full of Love" poster and food drop box — or even sponsor a food drive — call the Army at 453-5487.

The posters and boxes will be available for pick up soon.

YES, PICASSO WAS YOUNG ONCE, TOO

Surely, even a young Picasso spent time doodling and making amateur sketches. And, had the refrigerator been invented then, his mother's would no doubt have been covered with primitive masterpieces. Give your young artist the proper tools with the "Learn to Draw" artist kit from Colorbök. A colorful four-drawer box complete with crayons, colored pencils, watercolor paints, markers, an idea workbook and more. The complete set, \$25.

Jacobson's

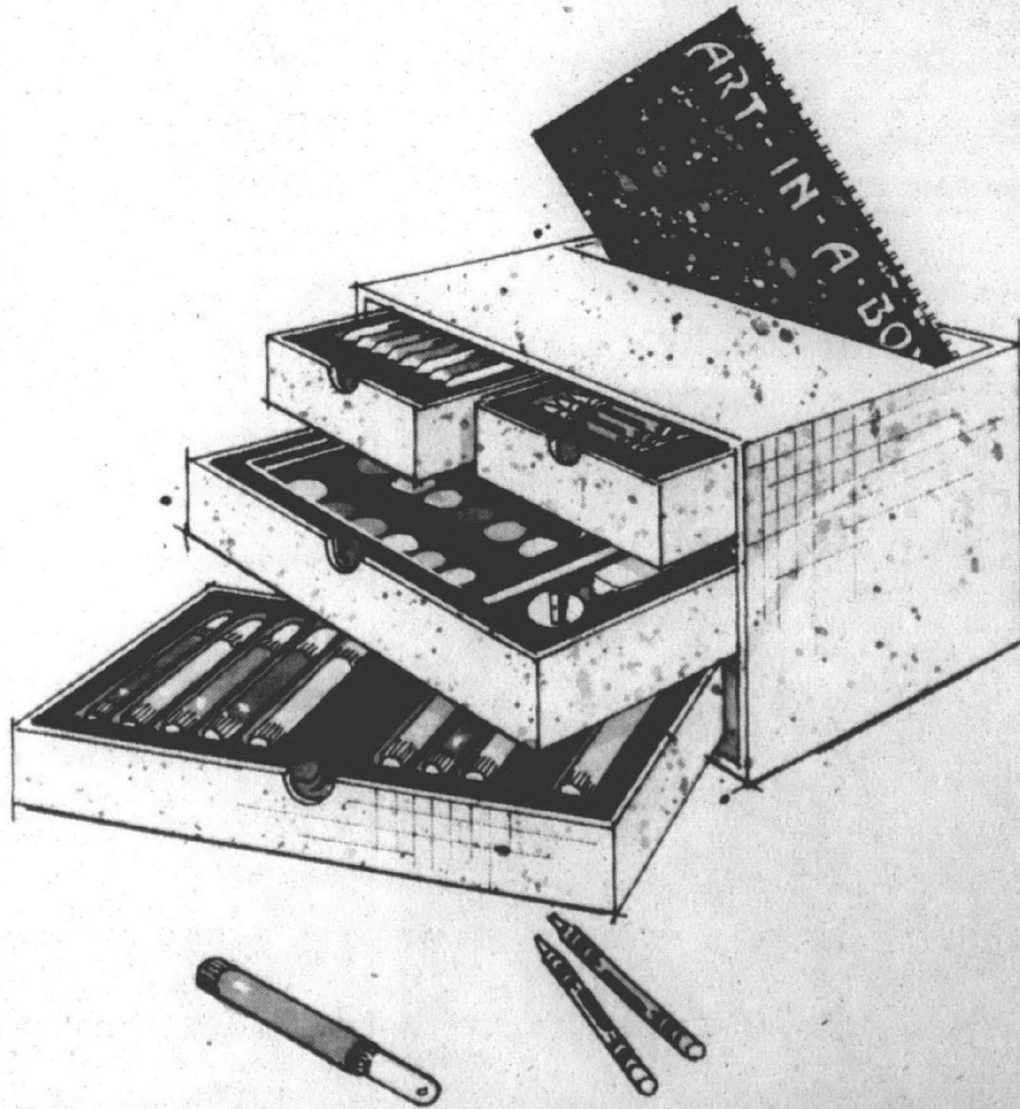

ANN ARBOR • GROSSE POINTE • BIRMINGHAM • DEARBORN • ROCHESTER • LIVONIA
Shop until 9 p.m. on Thursday and Friday. Until 6 p.m. on Monday, Tuesday, Wednesday and Saturday. Sunday Noon to 5 p.m. Jacobson's Charge, MasterCard®, VISA®, and American Express®.

Street SCENE

4A*

Monday, Nov. 23

PARADISE VALLEY JAZZ JAM
Alvin's, 5756 Cass, Detroit.
832-2355

Tuesday, Nov. 24

CHERYL WHEELER
The Ark, 637 1/2 Main, Ann Arbor.
761-1451

CHISEL BROTHERS WITH THORNETTA DAVIS
Alvin's, 5756 Cass, Detroit.
832-2355

NOJO NIXON
Blind Pig, 208 S. First, Ann Arbor.
996-8555

Wednesday, Nov. 25

BIG CHIEF
With Rollinghead and Mouth at State Theatre, 2115 Woodward, Detroit.
961-5450

GOOBER & THE PEAS
St. Andrew's Hall, 431 E. Congress, Detroit. Tickets are \$6.50 in advance.
961-MELT

TOTHU YINDI
The Majestic, 4140 Woodward, Detroit.
833-9700

MULE
With Cathouse at Alvin's, 5756 Cass, Detroit.
832-2355

UGLY BUT PROUD
With B.B.C. at Griff's Grill, 49 N. Saginaw, Pontiac.
334-9292

MISSIONARY STEW
With Jason McCauley Berry at Lili's, 2930 Jacob, Hamtramck.
875-6555

SCOTT STERN AND THE TRUST
Doug's Body Shop, Woodward Avenue, south of Nine Mile, Ferndale.
398-1940

REGULAR BOYS
Sully's, 4758 Greenfield, Dearborn.
846-1920

GEORGE BEDARD AND THE KINGPINS
Blind Pig, 208 S. First, Ann Arbor.
996-8555

MOTHER SUPERIOR
With Mirror Mirror and 10-Foot Pool at Paychecks, 2932 Caniff, Hamtramck.
874-0254

Thursday, Nov. 26

BLASPHEMOUS
3D Club, 1815 N. Main, Royal Oak.
589-3344

Friday, Nov. 27

THE FINAL CUT
With Majesty Crush at St. Andrew's Hall, 431 E. Congress, Detroit.
961-MELT

POLISH MUSLIMS
With Cathouse at Griff's Grill, 49 N. Saginaw, Pontiac.
334-9292

BENEFIT FOR HEMP AWARENESS
With Cylinderhead, Leaping Gnome and Forehead Stew at Alvin's, 5756 Cass, Detroit.
832-2355

BOP (HARVEY)
The Majestic, 4140 Woodward, Detroit.
833-9700

DISCIPLINE
Lili's, 2930 Jacob, Hamtramck.
875-6555

ASIA
The Ritz, Frazho Road, Roseville.
778-6404

CANNIBAL CORPSE
With Fat Tuesday and Willard at The Marquee, 8139 E. Seven Mile, Detroit.
366-8633

SHAWN PHILLIPS
The Ark 637 1/2 Main, Ann Arbor.
761-1451

PAUL VORNHAGEN QUARTET
Bird of Paradise, 207 S. Ashley, Ann Arbor.

662-8310

BUGS BEDDOW BLUES BRIGADE
Q Club, 29 S. Saginaw, Pontiac.
334-7411

KIM WILSON'S BLUES EXPLOSION
Sully's, 4758 Greenfield, Dearborn.
846-1920

TRINIDAD TRIPOLI STEEL BAND
Rick's Cafe, 611 Church, Ann Arbor.
996-2748

STEVE FERGOUSON OF NRSQ
Blind Pig, 208 S. First, Ann Arbor.
996-8555

WITS END
With Top Soil and Flock at Paychecks, 2932 Caniff, Hamtramck.
874-0254

9232 ME
With Technotworks at Finney's Pub, 3965 Woodward, Detroit.
831-8070

JAX MYTH
Cross Street Station, 511 W. Cross, Ypsilanti.
485-5050

Saturday, Nov. 28

MINISTRY
With Helmet and Sepultura at the Michigan State Fairground's Coliseum, Woodward Avenue and Eight Mile, Detroit.
645-6666

10,000 MANIACS
State Theatre, 2115 Woodward, Detroit.
961-5450

P.J. HARVEY
With David J at St. Andrew's Hall, 431 E. Congress, Detroit.
961-MELT

THE CRABBY JACKS
Griff's Grill, 49 N. Saginaw, Pontiac.
334-9292

BLACK PLANET
With Claim to Fame at Alvin's, 5756 Cass, Detroit.
832-2355

FRANK ALLISON
Rick's Cafe, 611 Church, Ann Arbor.
996-2748

RON WOOD
The Ritz, 17580 Frazho, Roseville.
778-8150

MATT WATROBA AND MICHAEL BARRETT
The Ark, 637 1/2 Main, Ann Arbor.
761-1451

PAUL VORNHAGEN QUARTET
Bird of Paradise, 207 S. Ashley, Ann Arbor.
662-8310

DANZIG
Harpo's, 14238 Harper, Detroit.
824-1700

BUGS BEDDOW BLUES REVIEW
Q Club, 29 S. Saginaw, Pontiac.
334-7411

KIM WILSON'S BLUES EXPLOSION
Sully's, 4758 Greenfield, Dearborn.
846-1920

DAD BLASTED
With Wig at Blind Pig, 208 S. First, Ann Arbor.
996-8555

SECOND SELF
With Daddy Stitch and Bermuda Mohawk at Paychecks, 2932 Caniff, Hamtramck.
874-0254

RESTROOM POETS
With Vambo Marble Eye at Finney's Pub, 3965 Woodward, Detroit.
831-8070

WOOD PAUL
Cross Street Station, 511 W. Cross, Ypsilanti.
485-5050

Sunday, Nov. 29

BENNY & THE JETS
Office Bar, Telegraph Road, north of Five Mile.
730-1627

Monday, Nov. 30

PARADISE VALLEY JAZZ JAM
Alvin's, 5756 Cass, Detroit.
832-2355



Regrouped: Members of the back-to-basics Vudu Hippies includes bassist Chris Newberg, vocalist Renee Paquette, drummer Brad Schrage and guitarist Graham Cousens.

Vudu Hippies: Back to basics



What do you do if your highly anticipated New York showcase draws and audience of seven? If you're the Vudu Hippies, you head home to get leaner and meaner, so to speak, and get back to the basics that made your music click in the local clubs in the first place.

BY LARRY O'CONNOR
STAFF WRITER

There they sat in a Manhattan McDonald's at 2 in the morning.

Five frightened, disillusioned musicians left to decide their fate after it was seemingly sealed following a highly anticipated showcase went bust at the venerable New York club CBGB's when only seven people turned up.

"And three of them we were related to," said bassist Chris Newberg, 22, who is from Birmingham.

The Vudu Hippies were a frayed lot that June night, having come full circle from the ebullience and enthusiasm that marked their highly touted arrival on the local scene three years ago. Reality arrived and it wasn't a cheeseburger.

Amid the discarded Big Mac containers, Newberg said the band decided to get back to basics. That meant the painful process of letting go of one of its guitarists, putting together a fresh collection of new songs and going into the studio.

The result is "Happy Medium," an 11-song testament to the resiliency forged from weathering a few crises and the musical maturation of an ambitious group of artists.

This is easily discernible in the robust guitar pop stylings in songs such as "Edge of the World" or "To God."

The Vudu Hippies' more seductive num-

bers, though, speak to uncertainty. Those may come in the pensive "Slow Bass" or the emotionally strewn "2 Sisters," which chronicles the disintegration between split personalities. The brooding number is written in the first and the third person.

"It symbolizes the record," said Newberg, who is one of the band's primary songwriters. "There's a lot of emotion and a lot of misrepresentation in it."

Such rancor wasn't present when the Vudu Hippies started fresh out of high school (Birmingham Brother Rice and Marian). Rather the enthusiasm of vocalist Renee Paquette, 21, drummer Brad Schrage, 21, and Newberg could barely be contained.

The Vudu Hippies promptly released a cassette, "Smarties," which draws grimaces today from band members. They also ingratiated themselves at a host of clubs in Ann Arbor and Detroit with their thoughtful and engaging performances.

The realities of the music business seeped in. A host of guitarists had already come and went as they initially performed as a five-piece band.

When guitarist Graham Cousens, 23, joined the group earlier this year, things finally looked settled. Then came the showcase in New York in June, which was preceded by a grueling 18-hour bus ride and a frightful stop in Cleveland.

With the debacle at CBGB's also came the realization one of the guitarists would have to go. The odd man out was Schrage's brother Rick.

"Up until that day, it was the hardest thing I've ever had to do," said Schrage about telling his brother. "He took it well, though."

Such experiences have made the Vudu Hippies wiser. They've grown in other ways.

Paquette's voice has always been the dynamic in the band and capable of kicking up a vocal dust storm reminiscent of ex-Lone Justice singer Maria McKee. Such emotional wailing, though, is now tempered by self-assuredness.

"I knew my limits now where before I didn't," said Paquette, who is from Southfield. "I would try to overdo it before. . . I thought having a small range was bad, but it's not."

The Vudu Hippies' range on stage is confident, largely devoid of posing and cliched theatrics. A recent show at Rick's Cafe saw the band in riveting form.

"Happy Medium," which will be released in January, has the same attributes.

"It's a transitional record," Newberg said. "It was a transitional time for the band . . . which gives it a full range of emotion and diversity on the album."

Having grown up, one wonders where there's left to go? Replied Newberg, "I think where we're going is deeper into ourselves."

Vudu Hippies perform on Thursday, Dec. 3, at Rick's Cafe, 611 Church, Ann Arbor. The show is a benefit for Mott Children's Hospital. For information, call 996-2747.

At Industry

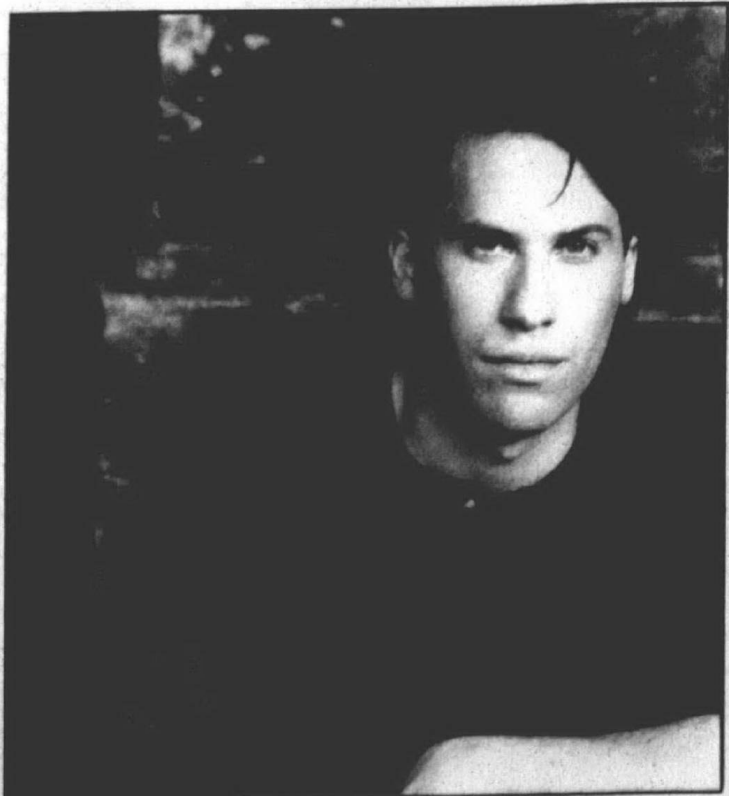

City wise: Singer-songwriter Atanas will perform songs from his current release, "Conscience of the City," at 8 p.m. Friday, Nov. 27, at Industry, 15 S. Saginaw, Pontiac. Tickets are \$5 at Industry or all TicketMaster outlets.

REVIEWS

DRY — PJ Harvey

At a time when high-tech gimmickry has extended its grip to most forms of alternative music and "rockers" whose ideas were entombed a generation ago are hailed every time they churn out a top seller, PJ Harvey's "Dry" is a welcome change.

The fittingly titled debut by the Dorset-based trio offers a sharp, unadorned sound led by the strong vocals and sure guitar of the band's eponymous founder.

The group, which formed in July of last year, claims a wide range of influences that include early Rolling Stones, Elmore James and Captain Beefheart.

"Dry" opens with "Oh My Lover," a slow, mournful, bass-driven plea to a paramour.

With "Dress," the danceable third cut, Harvey shows off her muscular vocal style in a celebration of sensuality. The group, Ste-

phen Vaughan leading the way on bass, shows a similar athleticism on "Sheela-Na-Gig."

The pace slows a bit for the ironic "Plants and Rags," on which an acoustic guitar and a cello are prominent. The song, written by Harvey and Robert Ellis, tells of a broad imagination that helps ease a limited material life.

Ellis, who plays drums and harmonium and adds vocal backing, also shares writing credits with Harvey on "Joe." An able group of studio musicians assisted the trio for the album.

— Matt Jachman

"Dry" is available on the Indigo label. PJ Harvey will appear Saturday, Nov. 28, at St. Andrew's Hall, 431 E. Congress, Detroit. David J. opens. Tickets are \$7.50 in advance. For information, call 961-MELT.



Spike converses with 'Malcolm X'



JOHN MONAGHAN

Like him or not, Spike Lee sure knows how to stir up the media. He urged students to cut class last week to check out his new screen biography of "Malcolm X." He irked the press in his attempts to accommodate only black journalists for interviews.

Spike's got \$30 million riding on this project along with his reputation. The great thing is that "Malcolm X" is every bit as good as Spike says — a fair, surprisingly objective biography of the controversial black leader, featuring a knockout lead performance by Denzel Washington.

Clocking in at almost 3 1/2 hours, this truly epic film opens with Malcolm Little as a young dandy

in a zoot suit walking Harlem streets with long loping arm strokes.

Harlem's golden age is presented almost in the context of the Hollywood musical, complete with a raucous dance scene. This is heaven for Malcolm with its fashionable denizens, trend-setting jazz, and for a smart guy like him, loads of opportunity.

Malcolm engages in some numbers running and burglaries with best friend Shorty (played by Spike Lee) before the pair ends up in prison. It's here that Malcolm meets Barnes (Albert Hall), a persuasive fellow con who teaches him the discipline and pride of the Muslim faith.

He becomes a Muslim behind bars and on release is immediately taken into the fold. His oratory and powerful presence make him one of the organization's most sought-after speakers.

So popular is Malcolm that many Muslims fear that he is

grandstanding for the press. These accusations, along with a sex scandal involving leader Elijah Muhammad, causes Malcolm to break off on his own, a move that directly leads to his assassination in 1965.

From what I've been able to gather, "Malcolm X" paints a fairly realistic portrait. Sure, you know where Spike stands. He obviously idolizes the man. Yet, he also depicts Malcolm's frequent bad judgment, inappropriate public statements (he labeled the Kennedy assassination "chickens coming home to roost") and overt sexism.

As a character, Malcolm is so thoroughly amazing and entertaining because of his chameleon-like transformations over the years from drug-pushing Detroit Red (so called for his years residing in Michigan) to the enlightened Malik El-Shabazz who makes a soul-searching pilgrimage to Mecca.

Denzel Washington, seen in virtually every shot, has the role of his life here. Not only does he strongly resemble the thin, bespectacled Malcolm, but he has the intensity to create more than a martyr symbol, something he was unable to do with Stephen Biko under the weight of Richard Attenborough's South African epic "Cry Freedom."

Watch Spike scream — and rightly so — if his star and his film are snubbed at the Academy Awards next year. It would be Spike's first Oscar; Washington's second.

Spike's ranting and raving makes perfect sense in the wake of this landmark film. Like Malcolm, he knows that wildly controversial statements will allow his voice to be heard. With films like "Do the Right Thing" and "Malcolm X" under his belt, that voice should echo for years to come.



At the mike: Malcolm (Denzel Washington) addresses an audience of Harlem residents outside the legendary Apollo Theatre.

PERSONAL

Scene YOUR PERSONAL PEOPLE CONNECTION **1-900-454-8088**
COST: \$1.49 PER MINUTE

1. Call 1-900-454-8088. Respond to an ad that appeals to you by pressing 1.

The cost is \$1.49 per minute. When the system answers, just follow the easy instructions. You will need to use the 5-digit voice mailbox number located in the ad you select.

2. Or browse through a selection of new and current greetings by pressing 2.

Including upcoming PERSONAL SCENE ads that will appear in the next issue of Observer & Eccentric Classified Ads.

3. Leave a message.

You'll hear a recorded greeting from the person who placed the ad. If that person sounds like the person you're looking for, leave your message!

4. Call anytime, 24 hours a day!

The Observer & Eccentric Newspapers PERSONAL SCENE line never closes — after all, you never know when the right person may have left a message for you!



You must be at least 18 years of age to place or respond to a PERSONAL SCENE ad. The Observer & Eccentric Newspapers assumes no liability for the content, response or any relationship resulting from an ad in this column. Participants agree to indemnify and not hold this publication responsible for any cost, expense (including attorney fees), liability and damage resulting from or caused by the publication or recording placed by the advertiser or any reply to such advertisement.

620 Men Seeking Women

AAS-SALAM-ALAIKUM Muslim seeks wife to help me become a millionaire and 100% minister in the new nation of Islam etc. 44341

ABSOLUTELY HANDSOME 27, single Italian engineer, seeks college educated gorgeous black female non-smoker, for lasting relationship. Sincere replies only. 44468

ACTIVE blue eyed 50's professional, 5'10", 170 lbs., seeks athletic, very bright, attractive self confident non-smoking gal who likes golf, food, passion. 44732

AFFECTIONATE caring, understanding professional white male seeks female unhappy with current situation for discreet relationship. Age/status unimportant. 44643

AFFECTIONATE, Professional degreed white male, 27, into fitness, skiing, outdoor activities. Non-smoker, no dependents seeking white female, 23-29 w/ same interests, relationship minded. 44655

AFFECTIONATE, sexy white male, 43, clean, slender, drug-free, non-smoker, drug free seeks similar black female for occasional discreet satisfying relationship. 44610

AFFECTIONATE, SEXY, white male, 44, clean, slender, drug-free, non-smoker seeks similar black female for passionate, discreet relationship. 44598

ARE YOU AN attractive white lady, in your 40's-early 50's, would you consider a fling with a 32 year old white male. 44692

ARE YOU LOOKING for someone who is honest, caring, affectionate, easy going & decent looking? Well, look no further. I'm a single white male, 25 yrs, 5'8", 155 lbs., dark brown hair, blue eyes. 44587

ARE YOU SHY? 28-42? Not overweight? Open minded? An unpretentious flower? This fit, westside sensual attractive male can help you bloom. 44623

ARTISTIC, romantic, white male, 40's, 5'10", trim beard, non-smoker. Seeks trim, spontaneous, passionate woman (30-40), likes movies, dancing, photography, & walks. 44464

A SLIM, TALL handsome male (38), financially secure looking to meet an attractive female for on-going relationship and romance with possibility for more. 44141

ATTRACTIVE Nice Guy, 39, honest and sincere. Morning person, athletic, enjoys country living, movies, snuggling, smiles and quiet evenings. Looking for same, non-smoker. 44617

ATTRACTIVE, physically fit, neglected married white male, 29, seeks married female for daytime sensual encounters. Age unimportant. 44542

ATTRACTIVE professional white male, 6', 180lbs, seeking intelligent, attractive slim black female 21-35. Call & we will discuss our common interests. Novi area. 44648

ATTRACTIVE Professional, honest, caring male, 26, loves pumping iron, rock & rolling thru the night, if you've got the stuff, then let's rock. 44608

ATTRACTIVE single white male, 31, never married, 6'4", 240 lbs. muscular, enjoys gym, water sports, seeks physically fit, attractive single white female, 21-28 years. 44639

620 Men Seeking Women

ATTRACTIVE single white male, 37, 170 lbs., physically active, likes outdoors & a few sports, a caring & understanding person. Humorous & serious in life. Seeks single white female 25-34. 44422

ATTRACTIVE white male 30 yrs, 5'9", brown hair/eyes, 165lbs, loves camping, fishing, movies, & romantic activities. Seeks white female with same interests, 23-32. Lets begin as friends. 44646

ATTRACTIVE white male, 5'10", 165 lbs, average build brown hair & eyes is seeking single white female, 20-28 on slender side, without children. 44585

ATTRACTIVE, young looking black male 50+, 5'8", 160 lbs. Secure, easy going, shy but romantic. Seeks open minded female, slender, 40-45, unattached for on going relationship. 44451

BLACK BROTHER seeks white sister for fun times. Call today for the excitement of your life! 44695

BLOOMFIELD HILLS very successful entrepreneur, 5'6", mid 40's is looking for a partner between 25-40 who is equally successful to share a wonderful life. 44695

CAN'T FORGET HER, met at Kick's in July, Blonde, wavy hair, 20's, adorable. Her name is Cindy? Kiss? Lives, works for a couple in Royal Oak. Any information appreciated. 44698

CHEERFUL, Professional, 5'10", 160lb, 52. Enjoys travel, movies, dining, sports, good conversation, interested in meeting a physically fit non-smoking lady. 44595

CHIVALRY isn't dead, attractive white male, 33, 6'2", 185, brown hair, eyes, seeking affectionate female 21-35, that's into fitness or being active for friendship! 44587

CHRISTIAN MALE, brown skinned, small built, 5'8", 160 lbs. Seeking Christian female, small built. Purpose, friendship, companionship, someone to share life with. 44606

CREATIVE, Affectionate, white, attractive male, 40, 5'11", 165lbs, seeks slim, petite female 18-45 who shares special moments. Possible long term. 44382

CREATIVE - degreed good looking smiling Irishman 34, 5'8", 150lbs. Single but bored, needs stimulus of pretty woman with wit & wisdom. 44670

DISCRETE interracial relationship wanted. I'm black, 29, handsome, have afternoons free. You're white, pretty, passionate. 44446

DISCRETE White male with free time daily. Financially secure. Interested in meeting with white female, 24-36, attractive, attentive, nurturing, for interludes. 44658

DIVORCED white father of 3, 6', 165lbs, blue eyes, warm honest, smoker, seeking attractive, feeling white female to share friendship & romance. Garden City. 44705

FUN LOVING, passionate, kindhearted, tall, well built single white male early 30's, looking for sweet, easy going attractive female, 25-30, for fun, good times & honest, caring relationship. 44674

FUN-LOVING, romantic, divorced white male, 45, 5'10", 160 lbs, likes tennis, volleyball, dancing, movies, wine, good times, outdoors. Seeking candle-lit dinners, etc. Seeking that special significant other, will answer all. 44597

620 Men Seeking Women

DIVORCED white male, 46, seeking drug free, blue collar, looking for female companion, 30-40, slim, attractive, likes outdoors. 44652

EASYGOING, single white male, 30, fit, attractive, engineer, looking for companion who is active, petite, 5'2" or shorter to share good times for mature relationship. 44472

EDUCATED Professional, 5'10", 47, white, seeks honest woman with sense of humor for dining, dancing, movies/plays. Looking for a friend first, possible more. 44472

FETTERED FANTASY - White male 40's, non-smoker, educated enjoys dancing, cuddling, leather seeks attractive blonde, slim, 25-42, non-smoker. Friendship. 44547

GOOD - looking handsome and tall white male, looking for a serious friendship with a black or white female who looks nice & acts her age. My age is 20. 44666

GOOD LOOKING, rugged yet gentle. Outdoors man, sandy hair, blue eyes, 5'11", 170 lbs. Successful, single white male. Would appreciate a sweet girlfriend. 44098

GOOD LOOKING single white male 22 yrs, 6'3", 225 lbs. Athletic, professional. Not a player. Tired of bar scene. Seeks single white female for serious relationship. 44621

HANDSOME professional white male, 37, 5'9" 176lbs, successful, easy going, likes sports, music, romance. Seeks educated fun figured white female 25-45. 44626

HANDSOME, professional white male, 30, 6'2", 180 lbs, building his life. Successful, good looking, easy going, fun; seeks a physically fit body building female for friendship leading to relationship. 44175

HANDSOME White, professional man, outgoing, creative, intelligent, sharp, funny, thoughtful seeks attractive educated white female 23-33 w/similar attributes. 44709

HONEST, sincere, single white male, 41, 6'2", educated professional, athletic-build, enjoys sports, movies, plays, romance, seeking trim, attractive woman, 30-42. Rochester area. 44694

NICE Guy, 28, white, tall, slim, professional, enjoys sports, movies, concerts, travel, quiet evenings, social drinker, non-smoker. Seeks 22-28 female, similar interest. 44691

NICE, HANDSOME, affectionate single white male, 29, seeks a single Asian female who works a fun, romantic long term relationship. All replies answered. 44672

NICE looking divorced white male, trim, professional musician/band leader, shy. Latefront living boating dining out, sipping cocktails, non smoker looking for equally fit attractive outgoing female late 30's. 44647

NO MORE GAMES!!! Single white male, never married, sincere, caring, very romantic, seeking attractive female, 21-28, for relationship. 44630

NOT FOUND in the stores. Limited time only, seeking somebody for sincere, honest relationship. Jewish, white, divorced male, 50, religion no barrier. Varied interests. 44489

PROFESSIONAL Single White Male, 31, 6'2", fit, dynamic, Christian, handsome, outgoing, prefers lady 25-30, but not limited to, with like attributes & desirable. 44490

620 Men Seeking Women

I HAVE many interests and am a beautiful person. Single white male 27, 5'10" 162 lbs, want more work on friends to enhance my chance for a functional marriage. Seek fit attractive woman 23-34, for now possible friendships only. 44626

PROFESSIONAL, secure, single white male, 44, seeks lovely, white female, 30-47 for eternal romance, with or without children. 44625

PROFESSIONAL, moral, never married white male, 40, seeks relationship minded female. Enjoy movies, plays, sports. 44458

SINCERE Single White Male, 6'3", 37, average person, enjoys dining out, garage sales, movies, traveling north, looking for sincere single white female, cheerful, 23-39 to share life adventures, hopes & dreams with. 44217

SINGLE Black Christian Male, 37, with wide variety of interests, seeks Christian single unattached female for fun & friendship. 44078

SINGLE PROFESSIONAL, Indian male, 26 yrs, honest, caring, educated, enjoys dancing, music, dining out, adventures. Seeking professional, slender, single white female, 25-35, 25 yrs/yr with similar interests to share special times & possible relationship. 44526

SINGLE white female, 35, seeking single white female 25-35 for fun & friendship. Garden City area. 44566

SINGLE, white male, Westland area, 36, 6'1", football player type, looking for 30-40 year old companion to share good times. 44628

SINGLE white male, 34, no kids, athletic, easy going (degreed, 6'0", 190 lbs). Seeks classy lady, 27-35 who is unattached & looking for a forward thinking gentleman. 44705

SINGLE white male, slim affectionate, honest fun loving, and movie goer seeks non-smoking, westside single black female, 22-31, same qualities monogomous relationship. 44734

SOUTHERN Gentleman, 33 years, signal, 165 lbs. Blond hair, blue eyes. Likes swimming, camping, fishing, guitar and country music. Seeking younger lady. 44600

SUBMISSIVE - obedient, eager to please white male 44, clean, attractive, slender, discreet, seeks dominant female for occasional pleasure filled relationship. 44671

SWEAT - is sexy! Single white male 37 seeks single white female under 40 with a passion for running or athletics. Sense of humor necessary! 44663

THIS CEO White male, 38, 6'3", medium build, blue eyes, adventurous, sensual, very attractive, is looking for a well-adjusted career woman who enjoys life. 44485

WELL-ENDED Man seeks well-endowed lady. 44460

VERY FRIENDLY, intelligent, creative single white male, tall, 31. Enjoys movies, music, stimulating conversations & good times, seeking single white female, 20-37, with similar traits and interests. 44693

VERY HANDSOME, professional, black male, 27, humorous, outgoing, looking to meet slim, attractive woman between 25-40, any race, sincere relationship. 44429

WHITE MALE, 45, educated, seeks female who does not look back in anger, nor ahead in fear, but around in awareness. 44438

620 Men Seeking Women

TALL, dark, & handsome inside & out, white male, willing to devote my intellectually and physically independent mature woman. I'm mid-40's, advanced degree, active, in-shape, non-smoker. Please be an-eric, travel & romantic movies. If you would like to talk please call. 44622

THIS ISN'T easy but here goes. I'm white professional male, mid 40's, 5'9", 155lbs. I like candlelit dinners, movies, being romantic. My hobbies are hunting, fishing, boating, cooking. If you would like to talk please call. 44622

THIS - 48 yr. old white semi retired welder in good health, seeks an intelligent and physically responsive female. I am attracted to women who use their minds. I see myself as indulgent, and I especially admire the ideas of Eyn Rand. I anticipate living simply and experimenting with unique ways of living. 44744

WHITE Male, 28, 6'3", 235 lbs, desiring sincerity. Searching for white female, under 45, marriage minded, eventually, prefer non-smoker. 44325

WHITE, SINGLE, very youthful 40, easygoing, sincere, 5'8", muscular 140, all natural, country style. Needs pretty, trim gal to share music, nature, romantic monogamy. 44649

WORKS NIGHTS, very good looking white male, 35, 6', 175 lbs., brown hair, hazel eyes, (smoker) Seeking a pretty white woman, 25-35, slim-medium build, to spend some serious time with. 44657

YOUNG, 51 year old, divorced Birmingham area, educated, white male with love of all seasons, golf, skiing, theatre, travel. Seeks friend, lover, wife, with best attitude. 44629

34 YEAR OLD White single male, financially secure, enjoys movies, dinners, sports, looking for compatible female for fun & romance. 44654

46, white romantic writer loves discreet interludes with affectionate lady 50+ Please respond. Looking forward to writing love sonnets of our most enjoyable times. 44601

621 Women Seeking Men

ARE YOU TALL? Reasonably trim, 50+, white, single, educated, sensual, enterprising & desire the same with a fastidious epicurean woman who enjoys walks, humor, theater, good wine, fireplace. 44698

ATTENTION: Fireman & Policeman attractive ravened haired single white female, medical professional, 30, desires to date man in uniform. 5'5", non-smoker, love classic rock, concerts, camping. 44584

ATTRACTIVE divorced, redhead, 45, size 16. Enjoys movies, reading, cooking, music, etc. Seeking warm, honest, white male with good sense of humor, 40-55 to share fun times. Non-smoker. 44590

ATTRACTIVE, single white female, 27, career minded, seeking serious relationship. Interests include: exercise, travel & romantic movies. Lets hope something nice happens between us. 44628

ATTRACTIVE, Spiritual, Black Female, 40, 5'3" trim, seeking friendship with professional 45-55 who loves life, God and people. All races considered beautiful. 44100

ATTRACTIVE, TALL, classy, passionate white female, 40's, seeks white male, 45-55, w/same qualities, sense of humor & adventure. Desire serious relationship. 44506

ATTRACTIVE 46 single black female, loves jogging, concerts, outdoor activities & quiet evenings. Seeks attractive gentleman with sense of humor & adventure. 44633

ATTRACTIVE, 5'3", super full-figured white female, 39 who's romantic, playful, sincere, honest, passionate, fun & enjoys life, music, affection, movies, sense of humor. 44657

BALLROOM DANCING partner wanted. Divorced white female 46, 5'5", medium build, attractive seeks single white male for fine dining, humor & possible travel. Friendship 1st/possible relationship. 44556

BEAUTIFUL, busy, bright, 6ft, 270lb single white woman of 1, seeking John Goodman teddy bear type for camping, sports, cooking & possible relationship. 44627

BEAUTY & BRAINS - Professional model with MBA seeks classy, white gentleman over 50. I abhor hunters, bad teeth, marriage phobics. 44619

CLASSY brunette, 39, divorced, 5'2", 120 lbs. Sincere & loves spontaneity with cosmopolitan qualities. Easy going, sense of humor, enjoys everything from A to Z. 44668

A SINGLE, WHITE, good looking, athletic, professional woman seeking "Mr. Right Enough" an unattached guy, late 30's-early 40's w/ looks, brains & a heart. 44482

ATTRACTIVE BLACK FEMALE 30-40 white male for fine dining, something searching for a best friend to talk with and share the joys of life, between 30-40, race open. Let's talk. 44559

ATTRACTIVE, PETITE fun loving blond, social drinker, seeks tall, professional, good looking secure male 44-54. Race no barrier. 44644

ATTRACTIVE Professional female would like to meet white male over 6' tall, age 43-55, must enjoy dancing, traveling, wishing a one to one relationship. 44599

ATTRACTIVE Single female looking for someone who loves life, works days, likes to go up in the UP and loves children. 24-32. 44586

621 Women Seeking Men

EDUCATED - employed black female seeking established employed educated male who is understanding, honest, and rational and seeks no non-sense relationship. Race no barrier. 44667

EXCITING - attractive blond professional, 36, single parent seeks handsome, professional, financially secure, 35-45 for friendship-possible lasting relationship. 44669

HOW DO The Elite Meet? Trim beautiful blonde seeks her equal in a handsome, fit, affluent gentleman. 47ish, degreed, clubbed, world traveled. Golf a plus. 44687

LIVELY, bubbly gal, circa 1950's, not a size 8, but not an 18. Prefer power tools over flowers. Positive/upbeat. Are you? Looking ahead. Non-smokers. 44641

LONG LEGGED attractive white female, 31, 5'10" seeks financially secure tall dark handsome white male, 32-42. Likes golf, movies, dining out, traveling. 44560

MIDDLE AGE BLACK Christian female with lots of offer (intellectually, spiritually, physically) seeking Christian male over 40. 44317

Pretty, lonesome, autumn lady-brown eyes, 5 ft, 145 lbs. Lyrical, humorous, intelligent. Looking for Christian smoking social drinking, single male, 50-60. Come share. 44682

Pretty, very successful, entrepreneur, 35-45, very loving giving, full figured, seeking male, 46-late 60's who can love me for the person I am. 44139

PROFESSIONAL white female, 55, 5'3", prefer casual, country living, non smoking, non drinking atmosphere. Value openness, optimism, education, families. Enjoy gardening, grandchildren, picnicking. 44701

QUEEN CUB looking for Teddy Bear. Single white female, 42, 5'2", non-smoker, affectionate, fun-loving, seeking gentleman, 40-48, for lasting close relationship. All replies answered, Westland. 44589

QUIET, mature black lady seeks honest decent family man for relationship, 48-63. Must be sincere, good sense of humor, like sports, music, travel, dining out. 44685

SINGLE white female, 42, looking for male 35-45. My life is funny movie, garage sales, auto races, spectator sports. Social drinker, friends first. 44682

SOPHISTICATED LADY Desires "Entente Cordiale" with refined active gentleman 58+ No unhealthy addictions, please. 44579

SOPHISTICATED BLACK - Single female, professional, 40, enjoys fishing, traveling, cooking. Seeks employed male. Race open. I will answer all calls. 44340

DOE looking for Black Single white female 40, 5'10, reddish hair, brown eyes. Likes dancing, dining, friends cuddling, I'm honest, caring, affectional, need honest loving relationship. 44635

DON'T SPEND The Holidays Alone! Single white female 45, widow in search of non-smoking employed white male 40-60, who enjoys dining out, travel, dancing, movies. Seeking a friend first possibly more. One on one relationship. 44610

EUROPEAN LADY - 25 yrs old wants to meet gentleman from 30-40 yrs old. Married or single. Must be well educated & generous. 44745

621 Women Seeking Men

SOPHISTICATED, CULTURED, Attractive petite jewish female professional, seeks loving, sincere educated male non-smoker, 44-56, who enjoys concerts, theatre, movies, travel, romance, traditional values. 44703

STRIKING, beautiful divorced white female late 40's, catholic, traditional values, seeks considerate, divorced white gentleman 50-65, 5'10" or taller for friendship. 44355

TOUGH skin, soft heart, brown eyed beauty, 34, bohemian lifestyle. Seeks strong, honest, free man to handle imaginative, humorous, XL woman, plan on friendship. 44588

Unforgettable, classy, intelligent, sexy, multi-race, full figured, genuine man-pleasing woman, seeks old fashioned, romantic gentleman 37-54. Race open. 44541

WELL-blossomed Italian Rose, 36, divorced, 1 child, seeks white male, 33-45, non-smoke, who likes quiet evenings & romance, looking for friendship first, then relationship. 44592

622 Sports Interests

ATTRACTIVE, male, 30, seeks non-smoking slender female 25-32, for tennis, running, skiing, dinner, theatre, social events. Must be honest, sincere. 44505

SINCERE - female 32 enjoys sports, racquetball, wallball, Travel Chicago, Austin, Dining, Mitches, Monterey. Seeking single, easy going, male to enjoy above and more! 44747

623 Seniors

CARING AND SINCERE professional female late 50's. Young and fit with tennis, running, skiing, dinner, theatre, social events. Must be honest, sincere. 44717

HELLO, I'm 66, "conservative", white divorced & full figured, semi-retired & prefer relaxed casual lifestyle. If you're a secure white male looking for friendship call. 44736

STRAWBERRY BLONDE, 5'4", trim, non-drinking/smoking, Caucasian, Christian from Bloomfield Hills would enjoy meeting gentleman friend early 60's in my area. 44642

624 Travel Companions

FEMALE, white, widow seeking non-smoking male companion, (50-65) to travel to Pompano Florida for Jan, Feb & March. 44689

FUN - energetic white couple, late 20's, seeks white female or couple to fun times including dancing, concerts, traveling and other activities. 44664

GOLDEN LADY, bright, warm, blue eyed blond, 5'6", 125 lbs. 42. Utica, free to travel & work for nice attractive friendly gentleman. 44489

JET SETTER? Beautiful blonde with brains seeks her equal in a single, white, cultured, mid 40's, for 1st class world traveling. 44158

VERY ATTRACTIVE, sensual, passionate white couple, 35 & 31 seeking single lady for friendship, traveling & exploring common interests. 44476

WHITE married couple early 30's, fit & attractive, looking for attractive female for daytime, weekday fun & friendship. 44730

Attention

PIZZA LOVERS

During the month of November you will receive a free cheese Shields Pizza* when you place your five-line Personal Scene ad.

* One small pizza from any Shields suburban metropolitan Detroit location

METRO DETROIT'S FAVORITE DEEP DISH PIZZA

Shields

SOUTHFIELD Novi
1356-2720
356-9110

TROY Sterling Heights
Van Dyke at 16 Mile
979-9270
617-3131

AT WORK AT PLAY A PIZZA AT SHIELDS WILL MAKE YOUR DAY!

To place your own PERSONAL SCENE ad, call 591-0900/FAX 953-2232 or Mail us this coupon:

The following is kept confidential. We cannot publish your ad without it. Please print clearly.

Print your ad here. The first five lines are FREE. (Space provided equals one five line ad). There is a one-time \$10.00 charge for each additional line. Use additional sheet of paper if necessary. Please include payment for any additional lines.

All ads must be paid in advance.

Be creative, honest, include age range, lifestyle, self description, interests and the type of person you are looking for:

Ad copy (Please print clearly) 5 words per line.

Observer & Eccentric Newspapers/Classified

PERSONAL Scene

36251 Schoolcraft, Livonia, MI 48150

You must be 18 years of age or older to use Personal Scene.

Personal Scene recommends:

Meet in a well-lit and public place for your first encounter and do not give your last name or address until you are comfortable doing so.

Men seeking women 620 Sports Interests 622 Travel companions 624

Women seeking men 621 Seniors 623

SCREEN SCENE

HENRY FORD CENTENNIAL LIBRARY
13650 Michigan Ave., Dearborn.
Call 943-2330 for information.

(Free)
"Mr. Robinson Crusoe" (USA — 1932), 7 p.m. Nov. 23. In this last silent film made by the swashbuckling Douglas Fair-



Enchanting: Miranda Richardson and Josie Lawrence star in Mike Newell's "Enchanted April," at the Michigan Theatre through Nov. 29.

banks, a man bets he can live on a deserted island for a year.

MAPLE THEATRE
4135 Maple Road, Bloomfield Hills. Call 855-9090 for show times. (\$5.75 evenings; \$2.95 twilight)

"Flirting" (Australia — 1991). A coming-of-age film in which an outsider at a boarding school in the '60s falls for a fellow outcast at a nearby girls school. An award-winning Australian film from the makers of "The Year My Voice Broke."

MICHIGAN THEATRE
603 E. Liberty, Ann Arbor. Call 668-8397 for information. (\$5; \$4 students)

"In a Year of Thirteen Moons" (Germany — 1978), 7 p.m. Nov. 23 and 9:30 p.m. Nov. 24. A transsexual impulsively undergoes a sex-change operation to please his eccentric millionaire lover. Late director Rainer Werner Fassbinder shows us the last days of this doomed life as the millionaire reveals he is no longer in love.

"Victor/Victoria" (USA — 1982), 9:30 p.m. Nov. 23 and 7 p.m. Nov. 24. Another gender bender, this time a comedy by Blake Edwards about a down-and-out singer (Julie Andrews) who masquerades as a man and becomes the toast of Paris in the 1930s.

"Enchanted April" (Britain — 1992), through Nov. 29 (call for show times). Indeed enchanting, though sometimes overly

schmaltzy, story of four very different women who share a magical Italian villa for a holiday.

"The Professional" (Japan — 1992). Nov. 25-29 (call for show times). Based on a popular graphic novel series called "Golgo 13," about an international killer for hire who boasts that no target has ever escaped his sights. This violent brand of animation, dubbed "splatter-toons" by fans and critics, is definitely not for kids.

"The Wizard of Oz" (USA — 1939), 3 and 5 p.m. Nov. 28 and 4 p.m. Nov. 29. Everyone's favorite fantasy, with Judy Garland still battling the wicked witch and flying monkeys as the homesick Dorothy.

STATE THEATRE
2115 Woodward Ave., Detroit. Call 961-5450 for information. (\$1.89)

"Caddyshack" (USA — 1980), 9 p.m. Nov. 23. If you haven't seen it a million times already, find out why sports figures consider this the greatest movie ever made. Bill Murray's relentless pursuit of a dancing gopher is still the best thing about this cult comedy set in a posh country club.

— John Monaghan

HOLIDAY COOKIES \$1.00 OFF
Reg. \$4.00/LB.
With Coupon Good Thru 11-25-92

PUMPKIN PIES
Reg. \$3.95
Sale \$2.95 (or 2 for \$5.00)

Thomas WEDDING CAKES
27811 Five Mile Rd.
Livonia, Michigan 48154
(1/4 Mile W. of Inkster)
427-3995 427-9050

On the Town
DINING & ENTERTAINMENT

Corsi's
Served in our beautiful banquet hall.
We seat 400 guests for all occasions.
Perfect for your Holiday Party.

Wednesday Buffet

Featuring:
• Homemade Soups
• Salad Bar with Fresh Fruit
• 3 Homemade Pastas
• 1 Meat Entree and Vegetable
• Assorted Pizzas
• Homemade Bread & Garlic Rolls
• Dessert Table

Served 4:30 - 8:30 p.m.
Groups Welcome - Cocktails Available

531-4960
Adults Under 10 Years Seniors
\$6.25 \$3.75 \$5.75

We cater to all areas.
7 Mile between Inkster & Middlebelt
Livonia

E·R·N·E·S·T·O·S
An Italian Country Inn
A BOUNTIFUL BUFFET SPREAD
of
TRADITIONAL THANKSGIVING DAY ITEMS:
plus many of Ernie's Signature Italian favorites
• Assorted Fresh Salads • Slow Roasted Turkey
• Sage Dressing • Whipped & Sweet Potatoes • Giblet Gravy
• Roasted Pork Loin • Splendid Dessert Display

To Compliment Your Traditional Feast
You will Experience Tastes of Italy
• Antipasto Bar • Homemade Pastas
And Many More Favorites

Reservations Recommended -
Serving 12 - 7 p.m.
Adults Children
\$14.95 \$7.95
41661 Plymouth Rd.
Plymouth, MI
453-2002

Christmas in Plymouth ...
19th Annual
Christmas Arts & Crafts Show
Friday, Saturday & Sunday
Nov. 27, 28 & 29 • Dec. 4, 5 & 6

FREE ADMISSION & PARKING

Hours: Fri. & Sat. 11-6
Sunday 12-5
Plymouth Cultural Center
525 Farmer
For more information
call ... 455-6620

Sponsored by the City of
Plymouth Department of Parks & Recreation.

Thanksgiving at the
Holiday Inn
DETROIT METRO AIRPORT
Thanksgiving Day Buffet
Thursday, November 26, 1992
11:30 A.M. to 3:30 P.M.
5:30 P.M. to 7:30 P.M.

Adults \$9.95 Children 4-12 \$5.95
Seniors \$8.95 3 and under Free

Chef Carved Tom Turkey
Chef Carved Honey Glazed Ham
Beef Stroganoff with Buttered Noodles
Polish Sausage with Sauerkraut
Mashed Potatoes and Gravy
Home Style Apple Dressing
Sweet Potatoes • Baked Acorn Squash
Buttered Sweet Corn • Salad Bar
Dessert Table Featuring:
Pumpkin, Mincemeat and Apple Pies,
Cakes and Cookies
Beverages Included

Call 728-2800
for Details and Reservations

Holiday Inn 31200 Industrial Expressway
Romulus, MI 48174
DETROIT METRO AIRPORT

SPEND
THANKSGIVING AT
BIG FISH

A CHUCK MUER RESTAURANT
THURSDAY, NOV. 26
2-8 PM
700 TOWN CENTER DR.
DEARBORN

Thanksgiving Feast
Roast turkey, mashed potatoes, gravy, cornbread, stuffing, cranberry sauce, vegetable, pumpkin pie, choice of salad, bread, butter and coffee, tea or milk.

\$12.95
Children 12 and under \$6.95

Reservations are Recommended
336-6350

Mental illness has warning signs, too.
For a free booklet about mental illness, call:
1-800-433-5959
Learn to see the sickness.
American Mental Health Fund

We Invite You To Join Us
For Thanksgiving Dinner
Thursday, November 26
11 a.m.-4 p.m.

Enjoy a home cooked meal away from home at the Holiday Inn Livonia West and feast on our traditional Holiday Buffet. You'll get roast turkey with dressing, tender baked ham, carved roast beef, eggs, bacon, sausage and home fries; along with a complete salad bar, peel & eat shrimp, fruit and cheese, plus garden vegetables and potatoes. To top it off a dessert table with all your favorites. So this Thanksgiving, come on by for a great taste of home!!!

ADULTS ... \$15.95 CHILDREN 6-12.. \$8.95
SENIORS... \$13.95 UNDER 6 YRS.FREE

Holiday Inn
LIVONIA-WEST
I-275 at Six Mile Rd.
Reservations suggested...464-1300 ext. 7431

The American Inn
...taste the experience of GREEK DINING at one of the only Greek restaurants in the suburban area.
An Angelis Anastasiou restaurant...owner of Dimitri's of Farmington.

FAMILY ATMOSPHERE • FULL LINE OF BEER, WINE, LIQUOR & COCKTAILS

Offering a full menu of homemade Greek, Italian & American Dishes

HOMEMADE DAILY SPECIALS
Lunch Dinner
\$3.25-\$5.00 \$5.95-\$7.95

SUNDAY SPECIAL
Complete Family Dinner
12 Noon-10:00 p.m.
Including Soup, Salad, Main Course*, Potato, Dessert and Coffee, Tea or Soft Drink.

Fresh Roast Turkey with Stuffing **\$7.95 -**
Baked Bone-in Ham with Raisin Sauce
Roast Leg of Lamb **\$8.95**
Fresh Roast 1/2 Chicken with Stuffing

SENIOR CITIZENS
10% DISCOUNT - AFTER 3 P.M.

THANKSGIVING DAY FAMILY FEAST
12 Noon-10 p.m.
featuring complete meals of
• Baked Bone-in Ham with Raisin Sauce \$8.95
• Fresh Roast Turkey with Stuffing \$8.95
• Roasted 1/2 Chicken with Stuffing \$8.95
• Prime Rib au jus \$12.95
• Roast Leg of Lamb \$9.95
• Cornish Hen with Stuffing \$8.95
• Fresh Broiled White Fish \$10.95

Meals include Soup and Salad, choice of Potato and Vegetable, Rice Pudding or Ice Cream and Coffee, Tea or Soft Drink. Full Service Menu also available.

MAKE RESERVATIONS NOW!
Mon-Thurs 11 am-11 pm
OPEN 7 DAYS! Fri 11 a.m.-12 a.m., Sat 12 pm-12 a.m.
Sun 12 pm-10 pm

15800 MIDDLEBELT (Between 5 & 6 Mile Rds.) LIVONIA • 522-5600

Give Thanks this Holiday Season
and join the
Embassy Suites Hotel - Livonia
for a Bountiful Thanksgiving Brunch

Featuring: Hot & Cold Tables
Breakfast & Dinner Entrees,
Salad & Dessert Bars.

11:30 a.m.-3:00 p.m.

Adults..... \$15.95
Seniors \$13.95
Kids 6-10 \$7.95
5 yrs. & underFREE

EMBASSY SUITES
Livonia-Metro West
19525 Victor Parkway • Livonia
Located in Victor Corporate Park
(313) **462-6000** Ext. 625

Cookie controversy consumes commission

BY RALPH R. ECHTINAW
STAFF WRITER

The most contentious topic of discussion among Wayne County commissioners last week was whether the sheriff's department should buy 20,000 boxes of Girl Scout cookies.

The unusually lighthearted meeting was a far cry from what was expected to be a boisterous session on the new budget. The commission will take up the budget issue on Wednesday.

Instead, commissioners enjoyed an uncharacteristic spasm of amity marked by numerous temporary absences on the part of several commissioners, the occupation of the chairman's seat by three different commissioners, and a second vote on the Girl Scout cookie issue because some people weren't sure if a quorum was present for the first vote.

When the meeting began at 2:30 p.m. (a half hour late as usual), six of the 15 commissioners were absent: Otis Mathis, D-Detroit, George Cushingberry, D-Detroit, David Cavanagh, D-Grosse

Pointe, Susan Hubbard, D-Dearborn, Bryan Amann, D-Canton, and Maurice Breen, R-Plymouth. By meeting's end two hours later, all but Mathis, Breen and Cavanagh had drifted in.

Between start and finish, commission chairman Arthur Blackwell, D-Detroit, disappeared from the dais to be replaced by vice chair Jackie Currie, D-Detroit, as presiding officer. Then Currie departed the chamber and the just-arrived Cushingberry took her place. But Currie returned and Cushingberry took his usual seat. Then Blackwell came back and took over to finish the meeting.

Considering the speculation of late that a new chairman will be selected in January to replace Blackwell, one almost got the impression that "tryouts" were being conducted.

At one point, commissioner William O'Neil, D-Allen Park, forgot that Currie was no longer chairing the meeting and addressed Blackwell as "madame

chair." Everyone laughed, and Blackwell said, "I've got some boxing gloves if you're in doubt any time."

As to the Girl Scout cookies, the sheriff's department had requested that the commission approve spending \$6,800 for 20,000 boxes to supply residents of the Wayne County Jail with a low-cost dessert.

O'Neil wondered why they didn't go out for bids on the cookie contract. Commission attorney Ben Washburn said, "It's not a competitive bid because it's a sole-source supplier."

O'Neil replied, "It's a known fact that there are a zillion suppliers of cookies. We are opening the biggest Pandora's box. I can't wait for the M&M groups to come to us (and ask us to buy candy from them)."

The sheriff's department spokesman said the cost of desserts for inmates will be just two cents a serving with the Girl Scout cookies as opposed to 14 cents with regular desserts.

Commissioner Kay Beard, D-Westland, wanted to know what the serving size is. "I think they get two or three cookies," the sheriff's department spokesman said. "That's part of their meal."

The commissioners present at the time voted to approve the purchase with O'Neil abstaining to lodge his protest. But when Blackwell returned later, someone asked that the vote be taken again because no one was quite sure if they had the required eight commissioners present for the first vote.

The cookie purchase passed once again, with O'Neil proffering his now-familiar abstention.

Amann, who came into the meeting room about 30 minutes before it was all over, got in on the last of the cookie controversy.

"Why are we buying these for the guys in jail?" he asked. "Do they deserve cookies?"

Blackwell teased, "Ninety-five percent of those incarcerated get out, so be careful what you're saying."

drapery boutique OUTLET IS NOW OPEN SUNDAY!

CROSCILL COMFORTERS
Assorted Patterns
Values if perfect

Twin	Value \$90	34 ⁹⁹
Full	Value \$100	38 ⁹⁹
Queen	Value \$150	44 ⁹⁹
King	Value \$175	49 ⁹⁹

READY MADE SLEEVES
VALUES TO \$25
3⁸⁸ EA.

READY MADE BALLOONS
VALUES TO \$25
7⁸⁸ EA.

SOLID COLOR PERCALE 180 T. C. SHEET SETS

Twin	Value \$30	15 ⁹⁹
Full	Value \$45	22 ⁹⁹
Queen	Value \$60	28 ⁹⁹
King	Value \$75	35 ⁹⁹

COTTON TERRY TOWELS BY CANNON

Bath	\$5	3 ⁹⁹
Hand	\$5	2 ⁹⁹
Wash	\$5	1 ⁹⁹

DELUXE COTTON BLANKET BY FARIBO

TWIN-FULL-QUEEN-KING	20 ⁰⁰ EA.	ANY SIZE
----------------------	----------------------	----------

SOLID COLOR CHINTZ TOSS PILLOWS
2⁸⁸ EA.

White Goose Feather Down Sleep Pillows

STANDARD	VALUES \$24	7 ⁸⁸ EACH
QUEEN	VALUES \$28	8 ⁸⁸ EACH
KING	VALUES \$32	9 ⁸⁸ EACH

PILLOW PROTECTOR POLYESTER/ COTTON
STD. QUEEN KING
2⁰⁰ EACH
VALUE IF PERFECT \$4 TO \$6

LUCITE BATH ACCESSORIES 70% OFF
Lotions, tumblers, soap dish, T.b. holders, boutiques, flat tissue & wastebaskets

Warehouse Outlet Only - 12119 Levan
Between Plymouth Rd. & the Jeffries Hwy.
Open Monday through Saturday 10:00 to 5:00
Open Sunday 12:00 to 5:00 - Ph: 591-6061

Southeastern Michigan hospice opens new office

The Hospice of Southeastern Michigan will hold an open house at its new Wayne County office 2-6 p.m. Wednesday, Dec. 2.

Area residents are invited to attend and learn more about the hospice's staff and services. The new office is located at 9333 Telegraph in Taylor.

The hospice has been serving residents in Western Wayne since its founding in 1980. A team of nurses, physicians, social workers, health aides, bereavement counselors and volunteers, most residing in Wayne County, was established specifically for Wayne County in 1990.

The team, which serves about 80 patients daily, will now operate out of the new Taylor office.

The Hospice of Southeastern Michigan is the oldest and largest hospice in Michigan. Each year it serves more than 3,000 inhabitants of Wayne, Oakland and Macomb counties. For more information about the open house, call 291-9700. For admission information, call 559-9209.

SHARE! YOUR HOME AND HEART!

INVITE THE WORLD HOME by SHARE!ing your life with one of our international high school exchange students who wish to learn about America and SHARE! about their country.

All of our students speak English, are fully insured and have their own spending money.

Your local SHARE! Representative will help you select a student with interests similar to those of your family. Gain a special friend for life!

Meet a Brazilian!

HOST FAMILIES NEEDED!

CALL TODAY FOR INFORMATION: (313) 475-8471
1-800-835-8760

A Non-Profit Student Exchange Program

ERDT/SHARE!

THE DOLL HOSPITAL TOY SHOP

SALE
On Selected Items

3947 W. 12 Mile • Berkley (313) 543-3115
M, T, W, Sat. 10-5:30 • Th & Fri. 10-4 • Sun. 12-4
(conveniently located near I-496)

March Tire Co. GOOD YEAR

March Tire Co.

Plymouth 767 S. Main 455-7800	Farmington 33014 Grand River 477-0670	Southfield 28481 Telegraph 353-0450
Canton 5757 Sheldon Rd. 454-0440	Westland 35235 W. Warren 721-1810	

7:30 a.m. - 7:00 p.m.
Sat. 8:00 a.m. - 5:00 p.m.

CPA'S ARE POSITIVE ABOUT FRANKLIN BANK.



"We recommend our clients to Franklin Bank because they get the best rates and the lowest costs for commercial checking accounts."

When you're a small business or practice, every penny counts. So you'll appreciate the fact that Franklin Bank has the best rates and lowest fees for commercial checking accounts in Metropolitan Detroit. That's why we earn new customers everyday.

And besides watching your pennies, our caring banking professionals make it a point to learn all about your small business needs.

So call or come in today and let us get to know you. And your business.

MICHAEL E. DESMOND, C.P.A.
Desmond & Creighton, P.C.
Certified Public Accountants
305 E. Maple Road
Troy, Michigan 48083

Franklin Bank

358-5170
FDIC INSURED

Southfield • Birmingham • Grosse Pointe Woods

FREE
1 Gallon of Washer Solvent with
\$8⁰⁰ With Coupon
Expires 12-5-92

FREE
TIRE ROTATION WITH
LUBE, OIL & FILTER
\$18⁹⁵ Reg. \$33⁰⁰
Most Cars & Light Trucks
Expires 12-5-92 With Coupon

PREVENTIVE MAINTENANCE TUNE-UP

4 Cylinder	\$39 ⁹⁵
6 Cylinder	\$49 ⁹⁵
8 Cylinder	\$59 ⁹⁵

Includes resistor spark plugs, labor, adjust timing and carburetor where applicable. Check all fluids and filters, test battery and road test. Diagnostic Service Available. Most Cars and Light Trucks. Offer valid with this coupon. Expires 12-5-92 With Coupon

SEASONED GREETINGS

HONEYBAKED
The original spiral-sliced ham since 1957

GREAT GIFT IDEA!

HoneyBaked brand ham.
Fully cooked. Spiral-sliced.
HoneyBaked secret spice glaze.
Prepared fresh daily. Always available. Perfect for holiday gifts.

Over 200 HoneyBaked Ham Company stores across the nation to serve you. To send HoneyBaked brand hams anywhere in the continental U.S.A., call toll-free 1-800-892-HAMS.

HoneyBaked Ham Company Locations in Michigan

DETROIT (313) 862-8622	TAYLOR (313) 374-2600
ROSEVILLE (313) 775-7900	BIRMINGHAM (313) 540-0404
TROY (313) 689-4890	WEST BLOOMFIELD (313) 851-2400
LIVONIA (313) 525-2994	GRAND RAPIDS (616) 957-3430
DEARBORN HEIGHTS (313) 274-9600	FLINT (313) 851-2400

Opening Dec. 1992
Yorkshire Plaza
3320 Miller Road
(Just west of I-75 on Miller Rd.)

MasterCard and Visa accepted.

Utley from page 1A

a West T-shirt. A Seattle native, Utley told students that when he was their age, he attended a Catholic grade school. "You guys are lucky; you don't have to wear a damn uniform," he said.

Utley starred on the gridiron for Kennedy High School and Washington State University before being drafted by the Lions in the third round four years ago. "The Lions were the only team I wanted to play for," he said.

Utley described a typical day in his post-football life. Utley has an apartment in Denver, where he is receiving treatment at Craig Hospital.

"I get up at 6 a.m. and get a couple hours of medical help. After that, from 10 till about noon, I go to the gym and lift," he said. After lunch, Utley drives his specially-equipped van to Craig, where he undergoes rehabilitation.

Defies doctors

Utley already is defying doctors who said he'd never walk again. He's regained much of his mobility, and is learning to "gate," using parallel bars and braces to swing himself forward while holding himself upright.

Progress has been slow, but sure. "The first time I picked something up off the floor, that was a good day," he said. "The day I stood up without passing out, that was a good day." So was Super Bowl Sunday, when after trying for an hour and a half, Utley was able to open a can of Coke for himself.

Much of his free time is spent with girlfriend Debbie Riddle, a 1986 graduate of Rochester Adams High School.

"I still do the same stupid stuff; I just get caught a little quicker," he said.

Utley passed along some advice.

"Keep your heads straight, so when your time comes, you guys can be leaders," he said. "My parents always stood behind me. You have to find someone who will be a role model for you."

Program working

Utley, still muscular and broad-shouldered with an earring dangling from his left ear, said he's been thrilled with the enthusiasm the Thumbs Up program has generated across the country.

"It makes you feel good that people are aware of what's going on," he said. "I want to make sure there is a cure for this. I want myself to be fixed, and I want to everyone else to be fixed, too."

"How did you feel emotionally when you learned you were paralyzed?" asked a student.

"To tell you the truth, there was only one time when I felt down," said Utley. "It just took me a second to realize that's not what I wanted. There were a million things I could do before I was hurt, and there are still 999,999 things I can do. Don't worry about those things you can't do; don't waste time thinking about it."

Being an athlete, "I've never learned to give up. I never have and I never will," he added.

Thumbs up: Luis Duma flashes a thumbs up sign during the assembly.



Standing ovation

Utley, who's competing in triathlons and wheelchair races, says he believes in thinking positive. "Everyone has bad days; parents, adults, everybody. You just have to keep pushing. There's always something else out there you want. Just go out and get it."

Students, thumbs up, gave Utley a standing ovation.

"It's an honor to come here before you," said a clearly moved Utley. "Just focus on yourself; believe in yourself, because you're number one. No matter what happens, you're still who you are."

Utley said it's important not to look back. "You can't say, 'I wish... Don't do that. Go on from this day forward. I live for today, prepare for tomorrow and learn from yesterday so I don't repeat my mistakes.'"

Don't forget to dream, he added.

"When I'm feeling down, I envision riding my motorcycle, tilting back and relaxing. I make myself relax and feel good. Wish and



Enraptured: Eighth-grader Tony Heck listens to Utley.

dream. Never lose sight of your dreams. Dreams make things happen."

Utley will be back in town to attend the Lions' Thanksgiving Day game. Friday, Nov. 27, he'll visit Blackwell Ford at 41001 Plymouth Road just east of Haggerty to sign autographs from 1-3 p.m.

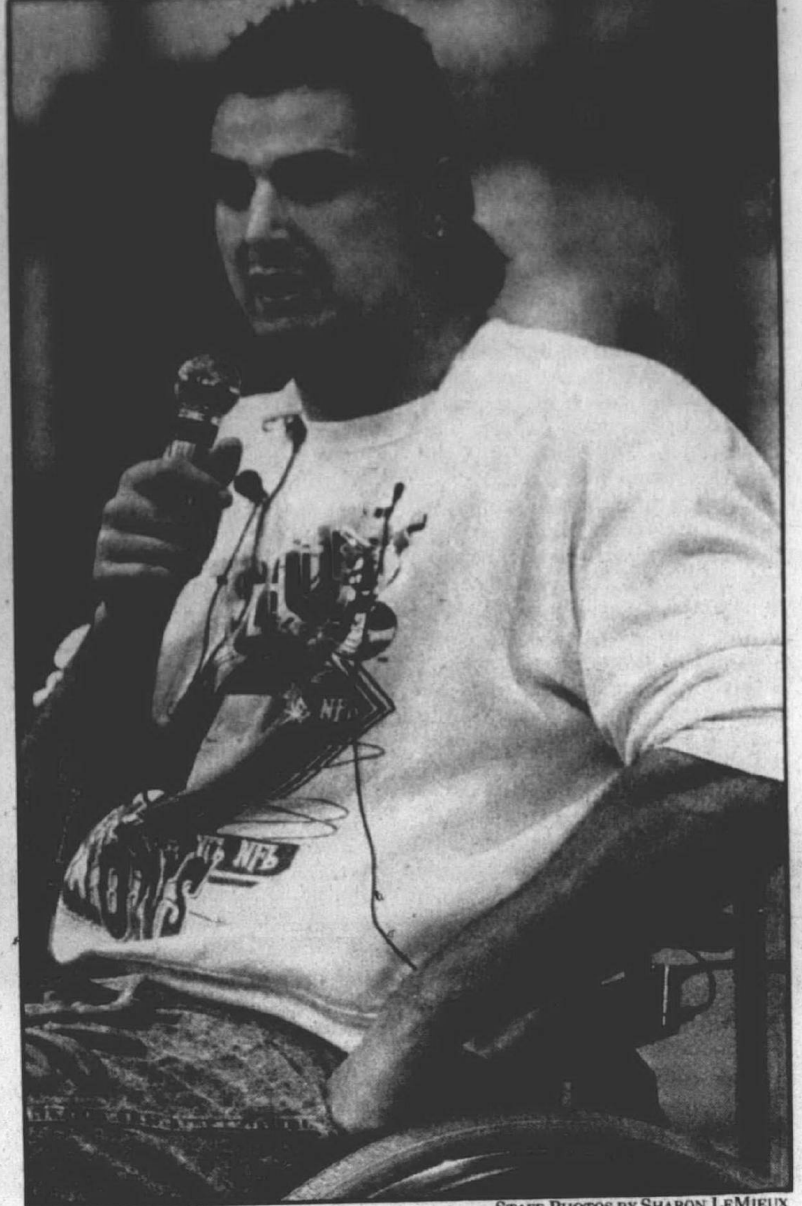

Utley visits: Former Detroit Lion inspires an audience in Plymouth Thursday.

Lawsuit from page 1A

Starr was flying the aircraft from Detroit City Airport to Benton Harbor, transporting a load of canceled checks.

Nix and Gunn, a flight instructor, were on a training flight that took off from Mettetal Airport in Canton.

NTSB investigator Mark Doub found that the Aerostar "impacted the Cherokee from the right rear," as evidenced by the location of propeller slashes in the right wing of the Cherokee.

"The regulations say the plane

in front has the right of way," Wolcott said.

The presiding judge in the case was John H. Gillis.

According to Doub, "Witnesses reported that both aircraft were on a westerly heading at about 1,000-1,500 feet when the twin-engine aircraft overtook, and flew through the single engine aircraft."

"They reported that immediately after the impact, the right wing came off the Cherokee and the aircraft spiraled vertically to the ground."

Sporting goods sale is planned

The Canton Parks and Recreation Services is sponsoring a used sports Equipment Sale from 10 a.m. to 1 p.m. Saturday, Dec. 5.

Sellers can bring equipment to Coventry Commons Shopping Center, next to Arbor Drugs at Joy and Morton Taylor Roads, between 6 p.m. and 9 p.m. Thursday, Dec. 3, to be priced and tagged for the sale.

For further information, call Bob Dates at Canton Parks and Recreation Services, 397-5110.

Recycling from page 1A

Sometime after the New Year, clear, green and brown glass will be accepted.

"They have to put it in some kind of rigid container, made out of plastic or metal," Russell said.

Also being accepted are:

■ Batteries — to go in a separate bag to be placed inside the recyclables bag.

■ Magazines, to be placed in a brown paper bag and kept separate from newspapers placed in another brown bag.

■ Junk mail, envelopes and paper, placed inside the recyclables bag.

■ Corrugated cardboard, set out loose with the trash.

"The residents will get a flier in the mail" detailing the new program, Russell said.

A video detailing the expanded program is scheduled for 7:30 p.m. Monday on cable TV Channel 15.



More recycling: Joe Russell, the city of Plymouth's solidwaste coordinator, shows how to get magazines ready for recycling. Magazines and other items will be added to the list of accepted recyclables.

HELP FEED THE HUNGRY

Buy a Case of Food



Use this coupon to Help Feed the Hungry. Gleaners Community Food Bank will use your donations to purchase the cases of food you select and distribute them at no cost to more than 180 soup kitchens, church pantries, and emergency shelters.

INDICATE THE NUMBER OF CASES OF EACH ITEM YOU WISH TO BUY FOR THE HUNGRY

- () Castleberry Beef Stew \$14.06 case
- () Bush's Deluxe Pork & Beans \$10.85 case
- () Star Kist Chunk Light Tuna \$40.00 case
- () Kroger Peanut Butter \$18.00 case
- () Welch's Grape Jelly \$19.35 case
- () Ragú Old World Style Spaghetti Sauce \$20.44 case
- () Healthy Choice Chicken Noodle Soup \$14.40 case
- () Kroger Instant Potatoes \$14.03 case
- () Beech Nut Baby Food \$ 7.20 case
- () Juicy Juice (Grape Juice) \$12.83 case
- () Sunshine HiHo Deluxe Crackers \$25.50 case
- () S-M-A Infant Formula \$24.86 case
- () Kroger Toasted Oats Cereal \$16.50 case

Gleaners salutes the above food industry associates for their involvement in our continued efforts to Help Feed the Hungry.

Enclosed is my check in the amount of \$ _____ for _____ case(s) of food as a tax deductible contribution to Gleaners Community Food Bank to Help Feed the Hungry.

Name _____

Address _____

City/State/Zip _____

Please make checks payable to Gleaners Community Food Bank and mail with this coupon to: 2131 Beaufait, Detroit, Michigan 48207

For more information call (313) 923-3535.

The best birthing center for lots of big reasons—and one tiny one



In two recent polls, St. Joseph Mercy Hospital (SJMH) was voted as having the best birthing center by readers of both Metro Times and Metro PARENT. In fact, the McAuley Family Birth Place at St. Joe's in Ann Arbor is fast becoming the name for up-to-date, family-focused maternity care, for lots of big reasons:

- One of the few birthing centers around to offer both LDR and LDRP suites
- Lots of options for pain relief, including labor epidurals and Jacuzzi bath tubs

- Tours, classes and other education to help you feel like an expert (even if it's your first baby)
- The excellent reputation of SJMH obstetricians

McAuley Family Birth Place's caring staff also strive for the best for the tiniest reason of all—your baby.

If you're pregnant and looking for an SJMH obstetrician near you, contact one listed here, or call ASK-A-NURSE anytime at 1-800-472-9696.

Canton McAuley Health Building, Ford Rd. at Lilley
 Donna Hrozencik, MD, and
 Yvonne Manber, MD (Suite 305) 981-6556

Plymouth Arbor Health Building, Ann Arbor Tr. at Harvey
 Norman Gove, MD (Suite 302) 455-5990
 Hugo Sanchez, MD (Suite 201) 434-0450

Catherine McAuley Health System

Sponsored by the Religious Sisters of Mercy founded in 1831 by Catherine McAuley

St. Joseph Mercy Hospital
 5301 East Huron River Drive
 P.O. Box 995
 Ann Arbor, Michigan 48106

S'craft seeks applicants for vacancies

BY RALPH R. ECHTINAW
STAFF WRITER

Help wanted: Part-time job, friendly co-workers, fancy title, lots of reading required, no pay.

That's not exactly the ad Schoolcraft College will take out, but the board of trustees is busily engaged in hunting up two people to fill the vacancies left by Jeanne Stempien and Thaddeus McCotter.

Stempien was elected to the Wayne County Circuit Court Nov. 3, while McCotter gained admission to the county commission. Both will take over their new jobs Jan. 1.

McCotter and Stempien turned in their resignations (effective Dec. 31) to the Schoolcraft board Wednesday. Hence the five remaining trustees can get down to the business of discovering replacements.

To be eligible to serve on the

Schoolcraft board a person must be a registered voter and live in the Plymouth-Canton, Livonia, Garden City, Clarenceville, Northville or part of the Novi school districts.

The board will accept applications through Dec. 15, then interview all the candidates on Jan. 6, 13 and 20. The new board members will be sworn in on Jan. 27.

Trustee Mary Breen said the board generally gets 10-12 applications when vacancies occur. The record is 27.

However, the newly appointed members must face the voters June 14 to keep their jobs. Current trustee Patricia Watson, who was appointed to fill a vacancy in October 1991, will also be up for election at that time.

Also, folks who apply for one of the appointments and don't make the cut have a chance to

get even next year if they want to campaign for one of the three trusteeships up for election in June.

Stempien has been a Schoolcraft board member since 1985, serving as chair for the last two years. In her resignation letter, she said, "(You have) my sincerest wishes for the continuing success of Schoolcraft College. The years that I have served as trustee have been very gratifying to me and I will treasure them always."

McCotter has been on the Schoolcraft board since June 1989. In his resignation letter, he said, "To my fellow trustees, the administration, the faculty and above all the students, I fondly say: I am proud to have served with you in serving this college and this community; and, because of your proven commitment to Schoolcraft and

this community, I know the college will continue on its course of excellence."

But McCotter and Stempien aren't the only Schoolcraft denizens bidding adieu to this particular institution of higher learning.

Executive secretary Joyce Ludwig, who has served three Schoolcraft presidents in 28 years of employment, performed her duties as board secretary for the last time Wednesday night, Dec. 14 is Ludwig's last day on the job, after which she'll head for Florida and a session with her new grandchild.

Ludwig's replacement, Fran Joswiak, 50, of Highland, was introduced at Wednesday's meeting. Joswiak was chosen from among 55 applicants, which is longer odds than Miss America faces.

Area residents named to benefit committee

Six Observer & Eccentric area people have been named to the advisory committee for the fifth annual dinner dance to benefit the preservation and restoration of the Henry Ford Estate in Dearborn.

They are: David Schlaff and Betty Jean Awrey of Livonia, Kitty Thayer of Southfield, Ron Roudebush, Roger Winkelman and Mary Beth Winkworth of

Bloomfield Hills.

The black-tie dinner dance has been scheduled for April 3 at the Ritz Carlton Hotel in Dearborn.

Construction of the Henry Ford Estate was completed in 1915. Home to auto pioneer Henry Ford and his wife, Clara, the estate includes a residence, power house, boathouse, miniature farmhouse and an adjacent 72 acres of gardens and grounds.

Ford home tours available

Feeling rushed? Escape to another time at the Henry Ford Estate on the University of Michigan-Dearborn's campus with a program called "Tour, Tea and Christmas Treasures."

This tour includes traditional English cream tea with a tour of

the estate, Michigan's only national historic landmark domicile open to the public.

The tour is available at 1:00 and 2:30 p.m. Dec. 2, 9 and '16. Tickets can be purchased at the gift shop for \$10 each. For more information, call 593-5590.

SC doubles scholarships

BY RALPH R. ECHTINAW
STAFF WRITER

The Schoolcraft College Board of Trustees voted Wednesday to increase the number of "trustee scholarships" available for area high school students from five to 10 per high school.

These \$800 or \$1,000 per year renewable scholarships are reserved for students graduating from Plymouth-Canton, Plymouth-Salem, Churchill, Stevenson, Franklin, Garden City, Northville and Clarenceville high schools.

Applicants with grade point averages between 2.75 and 3.499 are eligible for the \$800 awards. Applicants with GPAs from 3.5 to 4.0 can win the \$1,000 award.

High school seniors may apply for these scholarships beginning in May.

The annual cost of providing the trustee scholarships is expected to increase from \$79,800 to \$118,000.

Madonna seeks auction items

In preparation for its fifth annual "Around the World" scholarship dinner auction, Madonna University is seeking donations from businesses and individuals.

In the past, auction items have included trips to Hawaii, London, Disney World and Australia; fine jewelry, fine art, mink coats, TV sets, stereos, baseball cards, stuffed animals, software, theater tickets and health club memberships.

All donations are tax deductible and all proceeds from the auction go toward Madonna's scholarship fund.

To donate items, call Rose Kachnowski at 591-5063.

The auction will be held April 17 in the Laurel Manor in Livonia.

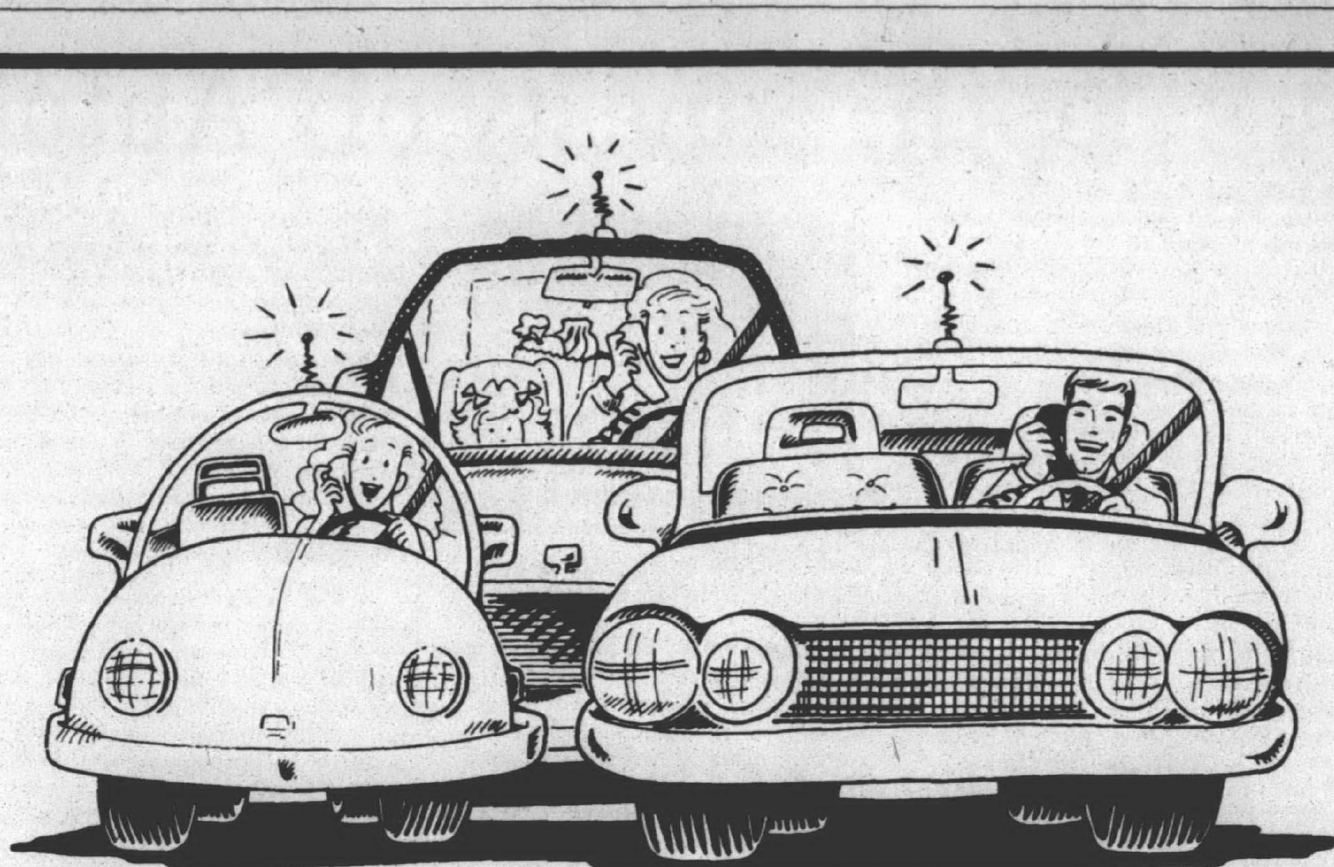

HOW TO KEEP BUSY SCHEDULES FROM DRIVING YOUR FAMILY APART.

Introducing the Ameritech Mobile Family Pack.

THE FIRST MOBILE PHONE PLAN WITH SPECIAL LOW RATES JUST FOR FAMILIES.

You're headed home from the office. Your husband's battling the stop-and-go after a sales call. And someone's got to remind Junior to pick up Bowser at the vet on his way home from practice.

If this sounds like a day in the



very busy life of your family, then it sounds like you need the Ameritech Mobile Family Pack.

It's the first truly affordable mobile phone plan with special prices just for families. See your nearest Ameritech Mobile dealer today.

1-800-MOBILE-1

Connect with the leader.
AMERITECH MOBILE

Call 1-800-MOBILE-1 or the Ameritech Mobile dealer near you:

- ALMONT**
Cellphone Communications
215 Branch St.
798-8881
- ANN ARBOR**
ABC Warehouse
Fretter
Henderson Glass
Highland Superstores
- AUBURN HILLS**
Metro Cell
2560 N. Squirrel Rd.
377-3333
1-800-LEADER-1
Henderson Glass
- BERKLEY**
Henderson Glass
- BIRMINGHAM**
Finishing Touches
Motorcycle Accessories
235 Pierce St.
645-2236
Hawthorne Home
Appliances & Electronics
- BRIGHTON**
Henderson Glass
- CANTON**
ABC Warehouse
Henderson Glass
- CENTERLINE**
Fretter
Highland Superstores
- DEARBORN**
Ameritech Mobile Sales & Service Center
2719 S. Telegraph Rd.
277-4111
- ABC Warehouse**
Dash Mobile Electronics
Highland Superstores
- DEARBORN HEIGHTS**
Henderson Glass
- DETROIT**
Ameritech Mobile Sales & Service Center
3334 E. Jefferson Ave.
259-5007
- Mobile Communication Services**
880 Oakman Blvd.
883-7575
Fretter
- Pecar's Metro**
Audio Center
11201 Morang
371-3480
- EASTPOINTE**
Ameritech Mobile Sales & Service Center
22371 Grant Ave.
777-0007
Henderson Glass
- FARMINGTON**
ABC Warehouse
Henderson Glass
- FARMINGTON HILLS**
Metro Cell
31122 W. Eight Mile Rd.
473-0331
1-800-LEADER-1
- FLINT**
Ameritech Paging Services
64029 Miller Rd.
1-800-232-5242
- ABC Warehouse**
Fretter
Henderson Glass
Highland Superstores
- FRASER**
Henderson Glass
- HIGHLAND PARK**
Highland Superstores
- LATHRUP VILLAGE**
Ameritech Mobile Sales & Service Center
28911 Southfield Rd.
557-8855
- Ameritech Paging Services**
26820 Southfield Rd.
1-800-458-1902
- LIVONIA**
Mobile Communication Services
34411 Industrial Rd.
427-1980
Fretter
Henderson Glass
- MADISON HEIGHTS**
Midwest Electronics
25831 John R.
543-7700
Fretter
- MT. CLEMENS**
Metro Cell
36884 Harper
790-9900
1-800-LEADER-1
- ABC Warehouse**
Fretter
Highland Superstores
- NOVI**
First Cellular
43450 Grand River
380-8338
Fretter
Henderson Glass
Highland Superstores
- PLYMOUTH**
Ameritech Mobile Sales & Service Center
620 W. Ann Arbor Rd.
451-0720
- PONTIAC**
Fretter
Highland Superstores
- PORT HURON**
ABC Warehouse
Henderson Glass
- REDFORD**
ABC Warehouse
- ROCHESTER**
The Sound Advantage
908 Main St.
656-1611
- ROCHESTER HILLS**
Ameritech Paging Services
2851 S. Rochester Rd.
1-800-523-8773
Hawthorne Home
Appliances & Electronics
- ROSEVILLE**
ABC Warehouse
- ROYAL OAK**
Royal Radio Sales & Service
617 N. Main St.
548-8711
Highland Superstores
- SHELBY TOWNSHIP**
Henderson Glass
Highland Superstores
- SOUTHFIELD**
Henderson Glass Cellular
24059 W. 10 Mile Rd.
350-2100
ABC Warehouse
Dash Mobile Electronics
Fretter
Highland Superstores
- SOUTHGATE**
ABC Warehouse
Fretter
Henderson Glass
Highland Superstores
- STERLING HEIGHTS**
Metro Cell
5963 E. 14 Mile Rd.
539-4690
1-800-LEADER-1
- ABC Warehouse**
Fretter
Henderson Glass
- TAYLOR**
Express Paging Systems
20127 Ecorse Rd.
382-CELL
- TROY**
General Cellular Sales
2787 Rochester Rd.
524-3232
ABC Warehouse
Henderson Glass
Highland Superstores
- Pecar's Metro**
Audio Center
3732 Rochester Road
528-2710
- WARREN**
Mobile Communication Services
27041 Gloede
772-2630
Dash Mobile Electronics
Henderson Glass
- WATERFORD**
ABC Warehouse
Dash Mobile Electronics
Henderson Glass
- WESTLAND**
Fretter
Highland Superstores
- WEST BLOOMFIELD**
Fretter
Henderson Glass
- YPSILANTI**
Future Sound
3069 Carpenter Rd.
971-8784
Dash Mobile Electronics

ONE WEEK ONLY

A Really Great Opportunity For A New Holiday Fur

TRIPLE • TRIPLE • TRIPLE

TRADE-IN

"Any Old Fur Can Be Exchanged For A Glamorous New Fur At Three Times Its Current Worth"

Go For It! Triple the Value Of Your Old Fur. You Deserve A Dittich Quality Fur

Through Saturday Only

Simply The Best...

Dittich
Since 1893

DETROIT 873-8300
BLOOMFIELD HILLS 642-3000
7373 Third Ave. (West of Fisher Building)
1515 N. Woodward Ave. (South of Long Lake Road)

POINTS OF VIEW

Conference shows more to learn about tolerance

Against a backdrop of the beating death of Malice Green, a long-planned community conference on racism was held in Birmingham last week.

Sponsored by the Birmingham Bloomfield Task Force on Race Relations, Focus: HOPE and the Race Relations Council of Metropolitan Detroit, it attracted a large, well-integrated, well-intentioned audience bent on "Getting to the heart of it: Taking our pulse on racism."

What was quite obvious from the general discussion and that which went on in small groups around the room was that the blacks attending knew a whole lot more about whites than we knew about them.

"Let's just talk about the word 'honky' — an epithet applied to whites by blacks. Most whites have had so little experience with blacks, except on our own terms, that we don't know its full meaning.

So when the groups analyzed a situation in which a white is referred to as a "honky" and a black as a "nigger," the whites didn't really know whether they could be equated.

How very little I know was recently reinforced when, purely by chance, I was part of an otherwise all-black audience.

My husband and I were in Chicago two weekends ago, and went with our younger daughter and her friend to a comedy club.

When we were seated, I looked around and noticed that my husband, daughter and I were the only white people there, with the exception of one waitress.

The truth: Had we known we would be the only whites, we would have been afraid to go.

And we would have missed a lot. We missed a lot anyway. Much of



JUDITH DONER BERNE

the humor and dialogue is hard to catch, when you have our small frame of reference. Yet, we expect blacks to negotiate in a white world every day.

"Hey, I see some whites up in the colored section," the black comedian said to good-natured laughter. A few minutes later, he called for applause because "they're supporting black comedy."

I thought of that experience when

Lila Cabbil, president of LMC Diversified Consulting, pointed out at the conference that blacks support white businesses but whites completely ignore black businesses, such as along the "Avenue of Fashion" at Livernois and Seven Mile Road.

I thought of that experience when keynote speaker Father William Cunningham from Focus: HOPE explained how carefully he trained young black men and women to take jobs in the white community — including how to talk to and treat "Mrs. Levandowski of Rochester."

"If you talk to Mrs. Levandowski, you can remember black is beautiful, but business is business," he tells them.

One Vietnam veteran told his group at the conference there had been virtually no discrimination in his military unit — probably because it was a case of survival.

Which drew the response: "We're not

looking at this issue as a survival issue — but we probably need to."

Incidents such as the beating death of Malice Green, the incessant killing of black children, and the fear that keeps many blacks on one side of Eight Mile and suburban whites on the other, attest to that.

Over five years, the task force in Birmingham has taken steps, such as this conference, designed to re-educate its institutions and residents.

It meets at 8 a.m. the third Monday of the month at The Community House in Birmingham. It's time for others to find out what the task force is doing and apply it to their communities.

You see, it's a matter of survival.

Judith Doner Berne is assistant managing editor for the Oakland County editions of the Observer & Eccentric Newspapers. You can reach her at 644-1100, Ext. 242.

Movie misses depth, honesty of 'Autobiography'

The critics are stumbling over themselves to praise Spike Lee's "Malcolm X." The words "masterpiece" and "epic" are being freely thrown about.

Unfortunately, the praise smacks of patronization because these critics briefly suggest what is wrong with this film and then scurry on as if they didn't want to offend the great black auteur or his black audience. Lee and his films are too important to be so shamelessly patronized.

"Malcolm X" is a big, ambitious and important movie. It is a must-see for those who have any interest in American history and in strong, intelligent films. On the plus side, Lee stays true to the "Autobiography." He doesn't reject the controversial ending in which Malcolm moves from strict separatism and racial hatred to a more accommodating position.

Denzel Washington gives an outstanding performance as Malcolm. He

captures the fire and anger, but he also captures the humanity in his sly smiles and in the growing awareness of his spiritual being. Other performances, especially Al Freeman Jr.'s dead-on Elijah Muhammad, are excellent. Lee's experiments with the medium are about 75 percent successful, especially the use of black and white as memory jolts to those of us who saw Malcolm through early '60s television.

So what is wrong? As in other Lee "joints" (his word for his works), there is a basic dishonesty in his portrayal of black inner city neighborhoods and life. In "Do The Right Thing," Lee's New York slum resembled nothing so much as a Sesame Street set. The streets were tidy, the conflicts until the end were also a little too tidy. In the end Lee's concepts were foggy. Danny Aiello's pizza parlor owner was the most humane character, which seems not at all what Lee had in mind. That



HUGH GALLAGHER

movie, too, was provocative and well acted but disquieting and disappointing.

In "Malcolm X" the problem is more serious. In the Alex Haley penned "Autobiography," which is one of the greatest books of our time, Malcolm goes through several spiritual transformations. The early part of the book tells explicitly what Malcolm went through as a child and young man. He is brutally honest about his life as a pimp,

pusher, drug addict and thief. He is blunt about his views of racism, but he is also blunt about the lack of self-esteem and responsible behavior in the black community.

The movie sadly misses all of this. The scene in which a teacher tells Malcolm to forget about being a lawyer and study for a Negro trade is one of the strongest in the book because it is told with subtlety and presented after establishing Malcolm's love of books and his good showing as a student.

In the movie, it is played for laughs with a caricatured white bigot teacher in loud clothes with a loud mouth. And it is only briefly mentioned that Malcolm was a good student. Later, Christopher Plummer plays another comic white, a vulgar preacher who knows God is a white man. In fact, all whites are reduced to comic walk ons as racists or twits (no doubt Lee's revenge for Steppin' Fetchit).

In the movie, the Harlem of the '40s is a way cool black amusement park where Malcolm and his little buddy, played by Lee, walk around in blinding zoot suits and wide brimmed hats. The music is hot and the games are slick. This is in the book but so is the other side. Where is the poverty, where is the brutal crime, where is the ravaging addiction, where is the irresponsibility that Malcolm later rebelled against? Malcolm's crimes are also treated lightly. This is far from the spiritual depths that the book details.

Do the right thing, see the movie, yes, but more importantly read the book!

Hugh Gallagher is an assistant managing editor with Observer & Eccentric Newspapers. To leave a voice mail message for him from a touchtone phone, dial 953-2118.

This'll have everybody talking.



Get \$150 off Ameritech Mobile phones, or rent a phone and the first year's on us!

Now Ameritech Mobile makes having a mobile phone affordable to everyone. Just sign up for an eligible service plan with a 12 month minimum term and get \$150 off the purchase of Ameritech Mobile phones. Or rent an Ameritech Mobile installed or bag phone, sign up for an eligible service plan, and get a monthly credit good towards a full year's phone rental from Ameritech Mobile. If you prefer to rent a portable phone, you will receive a \$150 credit against your monthly rental fee. Whatever option you choose, we'll waive the \$35 activation fee!

Call 1-800-MOBILE-1 or visit the dealer nearest you.

ALMONT Cellphone Communications 215 Branch St. 798-8881	Hawthorne Home Appliances & Electronics	DETROIT Ameritech Mobile Sales & Service Center 3334 E. Jefferson Ave. 259-5007	FARMINGTON HILLS First Cellular— 32730 Northwestern Highway 932-3870	HIGHLAND PARK Highland Superstores	LIVONIA Mobile Communication Services 34411 Industrial Rd. 427-1980	MT. CLEMENS Metro Cell 36884 Harper 790-5900 1-800-LEADER-1	PLYMOUTH Ameritech Mobile Sales & Service Center 620 W. Ann Arbor Rd. 451-0720	ROCHESTER The Sound Advantage 908 Main St. 656-1611	SHELBY TOWNSHIP Henderson Glass Highland Superstores	TAYLOR Express Paging Systems 20127 Ecorse Rd. 382-CELL	WATERFORD ABC Warehouse Dash Mobile Electronics Henderson Glass
ANN ARBOR ABC Warehouse Henderson Glass Highland Superstores	BRIGHTON Henderson Glass	Mobile Communication Services 880 Oakman Blvd. 427-9400	Metro Cell 31122 W. Eight Mile Rd. 473-0331 1-800-LEADER-1	LATHRUP VILLAGE Ameritech Mobile Sales & Service Center 26911 Southfield Rd. 557-8855	Henderson Glass	ABC Warehouse Highland Superstores	PONTIAC Highland Superstores	ROCHESTER HILLS Ameritech Paging Services 2951 S. Rochester Rd. 1-800-923-8773	SOUTHFIELD Henderson Glass Cellular 24059 W. 10 Mile Rd. 350-2100	TROY General Cellular Sales 2767 Rochester Rd. 524-3232	WESTLAND Highland Superstores
AUBURN HILLS Metro Cell 2560 N. Squirrel Rd. 377-3333 1-800-LEADER-1	CANTON ABC Warehouse Henderson Glass	Henderson Glass (3 locations)	FLINT Ameritech Paging Services G4029 Miller Rd. 1-800-232-5242	MADISON HEIGHTS Midwest Electronics 25831 John R. 543-7700	Henderson Glass	NOVI First Cellular 43450 Grand River 380-8338	PORT HURON ABC Warehouse Henderson Glass	Hawthorne Home Appliances & Electronics	Highland Superstores Dash Mobile Electronics	WEST BLOOMFIELD Highland Superstores	YPSILANTI Future Sound 3069 Carpenter Rd. 971-8784
BERKLEY Henderson Glass	DEARBORN Ameritech Mobile Sales & Service Center 2719 S. Telegraph Rd. 277-4111	FRASER Henderson Glass	ABC Warehouse Henderson Glass Highland Superstores	Henderson Glass	Henderson Glass	Henderson Glass Highland Superstores	REDFORD ABC Warehouse	ROSEVILLE ABC Warehouse	Highland Superstores Henderson Glass	WARREN Mobile Communication Services 27041 Gloede 772-2630	Dash Mobile Electronics Henderson Glass
BIRMINGHAM Finishing Touches Motoring Services, Inc. 235 Pierce St. 945-2236	DEARBORN HEIGHTS Henderson Glass	FARMINGTON ABC Warehouse Henderson Glass	ROYAL OAK Royal Radio Sales & Service 612 N. Main St. 548-8711	STERLING HEIGHTS Metro Cell 5963 E. 14 Mile Rd. 939-4660 1-800-LEADER-1	ABC Warehouse Henderson Glass						

Connect with the leader.
AMERITECH MOBILE

Participation may vary by distributor. \$150 on phone rebate applies to new line activations on Motorola phones. Rental offer good on Motorola AC250. Credit available on model updates. Minimum 1 year contract and promotional agreement required for pricing discounts and promotions. Standard credit check applies. Promotional offers end 11/28/92. Additional restrictions apply. © 1992 Ameritech Mobile Communications, Inc. All rights reserved.

Madonna marks 45 years prepared for future challenges

Madonna University marked its 45th anniversary last week with liturgy, campus activities and the announcement that the school has completed a five-year \$10 million fund-raising campaign and met a Kresge Foundation Challenge grant deadline of Dec. 1.

Madonna is the largest Catholic Franciscan University in the United States.

"From its founding in 1947 by the Felician Sisters of Livonia, Madonna has remained committed to the spiritual, educational and service-oriented mission of its Franciscan Catholic heritage," said Sister Mary Francilene, university president.

In the university's annual report for 1991-1992, Sister Francilene outlined the successes of the school. Quoting from one of her favorite scriptural passages (Exodus 14:15) "Tell the people to go forward" she urges supporters planning for the future: "Let us do it together."

An outgrowth of Presentation Junior College, Madonna has grown from a small women's college with 218 students to 4,419 men and women in 1992.

The liberal arts college started out in the Felician Sisters Motherhouse at Schoolcraft and Levan and offered only four programs - education, social work, medical technology and secretarial science. In 1959, Madonna was accredited by the North Central Association of Colleges and Schools.

The school became coeducational in 1972. The university prides itself on opening its doors to both older and younger adult varying in age, economic, religious, social and cultural backgrounds. Sixteen percent of total enrollment is composed of minority students. As of 1991 one-quarter of the student were men.

In 1975, the school initiated interpreting programs for communication with deaf people and admitted the first deaf students. Since that time, more than 500 deaf and hearing-impaired people have enrolled at Madonna.

Madonna now offers more than 50 undergraduate programs along with master's degrees in business, education and nursing.

In 1991, Madonna College became Madonna University. The school has had only five presidents - Sister Mary Paula (1947-1954), Sister Mary Assumpta (1954-1960), Sister Mary Raynelda (1960-1965), Sister Mary Danatha (1965-1976 and for the last 16 years Sister Mary Francilene.

In the 1960s the school's major buildings were constructed. Additional building followed - the Activities Center in 1971, a new \$4.5 million library and lecture hall in 1984, Educational Development Center in 1987 and the acquired Angelo DiPonio Building in 1991.

The announcement of the successful five-year fund-raising campaign and challenge grant, will mean more improvements at the Schoolcraft and Levan campus. The challenge grant from the Kresge Foundation is designed to aid students in the science-related fields.

"The Kresge Foundation approved a grant of \$300,000 toward Madonna's science renovation on a challenge basis to assist the university in raising the balance of the \$10 million campaign which was \$944,315," explained Sister Francilene.

Community leaders and friends of the university also have committed financial help over the years.

"Our future is predicated on hope and shared vision. We are a living, breathing, dynamic community of people," said Sister

Francilene. "We cannot do all that our mission challenges us to do without the support and involvement of many caring individuals who share the values, hopes and purposes of all humanity," she added.

Last Thursday, administrators, faculty, staff and student representatives attended a liturgy of thanksgiving. Recognition was given to many individual including those who have been with the university for 10 and 20 year periods.

Ann Marie Fowler, a junior music major, received the St. Catherine Undergraduate Achievement Medal. The award is presented each year through the Detroit Chapter of Kappa Gamma Pi to a student who has completed five semesters of college work at Madonna while maintaining a grade point average of 3.25 or better.

On Saturday, university benefactors participated in a special Eucharistic liturgy and banquet. Lifetime members of the President's Cabinet were presented with a medallion while those who have given sustained support for five and 10 years received plaques.

Donors, new to the President's Cabinet, received pins.

William T. Phillips, chairman of Phillips Service Industries in Livonia, is chairman of the Madonna University Board of Trustees. Recent newcomers to the board are William P. Connor, president and chief executive officer of Norquick Distributing Co. of Livonia and Lawrence A. Wisne, president of Progressive Tool & Industries Co. of Southfield.



STAFF PHOTO BY JIM JACZFIELD

University leaders: Some of those responsible for the college's success are Sister Mary Danatha Suchyta who was president from 1965 to 1976 and currently vicar and counselor for Presentation Province; Sister Mary Lauriana Gruszczynski, vice president for university advancement who was instrumental in the completion of the \$10 million campaign for academic excellence; Sister Mary Francilene Van de Vyer, president for the last 16 years and builder James S. Bonadeo, a member of the university board of trustees who served as chair of the 1992 Corporate Fund Campaign Benefactor.

Make Your Money Work For You!!

Listen to the "AJA Financial Hour" Tuesdays, 9:00 am to 10:00 am

WCAR 1090 AM

Hosted By: Tony Amaradio - President AJA Financial Planners, Inc. Bloomfield Hills

For Free Helpful Financial Planning Information Call In Phone Line 525-1090 Tuesdays, 9:00 am to 10:00 am

*Securities Through Coordinated Capital Securities, Inc. Member NASD and SIPC

Ward Presbyterian Church
17000 Farmington Road, Livonia, Michigan 422-1150

Thanksgiving Service
Thursday, Nov. 26, 1992 9:00 and 11:00 a.m.

"THANKSLIVING"
Senior Pastor Rev. Mark A. Brewer
200 Voice Chancel Choir

STOP SMOKING WITH ACUPUNCTURE

You've probably tried to stop smoking with all the usual ways. Acupuncture is an ancient Oriental way of therapy. It has proven very helpful in treating many of modern day problems and diseases. Smoking is one of them. NOW is the time to make a change and stop smoking with acupuncture. For further information, CALL

NANKIN PROFESSIONAL CLINIC, P.C.
Michael T. Nadelny, D.O.
29200 Vassar, Suite 800, Livonia

477-7344

Mercy High School Presents

12th Annual

CHRISTMAS Arts & Crafts Show

November 28th • 10-5 pm
November 29th • 11-4 pm

No Strollers Please!

Admission \$2.00

Please enter by Gate 1 or 2 only.
29300 Eleven Mile Rd.
Farmington Hills, MI

Spring Show
March 13, 1993

Insulate your windows with

ECP Magnetic Interior Storm Windows

- Eliminate Cold Drafts
- Seal your Window like a Refrigerator Door Gasket
- Reduce your utility bills
- Window uses 3M insulating technology
- Increase the comfort in your home
- Upgrade to Low-E without replacing your windows
- Buy Factory Direct

Call Today
FOR A FREE IN-HOME ESTIMATE
1-800-666-3233

10% OFF
LIMITED TIME OFFER

Choose Your Favorite **HOMEMADE PIE** For Thanksgiving

- Cheesecake
- Pumpkin • Lemon • Apple
- Cherry • Coconut Creme
- Blueberry • Banana Creme
- Chocolate Creme • Black Forest

BROWN'S
Fish & Chips, Inc.
5016 Greenfield (Between Ford & Michigan)
51 Years in Dearborn

ORDER NOW!
581-9474

Arthritis Today
Joseph J. Weiss, M.D. Rheumatology
18829 Farmington Road
Livonia, Michigan 48152
Phone: 478-7860

PAIN AND SWELLING

When joints are swollen, they are not necessarily painful. The reverse is also true: a joint can look perfectly normal at a time it is causing you intense distress.

Joint swelling and pain are in step when the swelling occurs suddenly. Swelling represents the accumulation of fluid in a joint; if the fluid flows in quickly, the joint capsule must distend rapidly. The sudden stretch affects the joint as if it were placed on a medieval rack.

In contrast, if the irritation is slight but sufficient to cause the joint to react, you may have a slow increase in fluid. The site would have time to adjust; you could develop large amounts of fluid so gradually you would not feel the need to seek medical attention.

You can have a great deal of damage to a joint with continual pain, and yet have no swelling. A typical instance is a ligament tear in a knee or ankle, or a shoulder rotator cuff tear. The makeup of joints includes not only tissue but nerve endings. In the case of injury, nerve endings are irritated by stretching or direct damage and express their disruption by signals you receive as pain.

Physicians experienced in arthritis do not need to see evidence of swelling to appreciate that your joints hurt badly. The features and pattern of onset often provide the information as to why you are in pain and indicate what treatment is in order.

Furnaces Heating Boilers
Service - Sales - Installation

8 Radio Dispatch Trucks to service all makes and models

24 Hour Service • Commercial • Res.

Sheet Metal Refrigeration

\$100 OFF Service Call
EXPIRES 12-5-92

TRANE

\$100 OFF on Furnace
EXPIRES 12-5-92

It is Illegal for Collection Agencies and Other Creditors to Harass You Over Your Delinquent Consumer Debts.

We recently obtained the largest known settlement in Michigan for a harassed debtor against a collection agency

For a free consultation call
(313) 258-9499

LISTEN TO OUR RADIO SHOW "LEGAL AFFAIRS"
Every Monday 8-9 p.m. on WCAR Radio 1090 AM

ZUPPKE & WISEMAN, P.C.
Attorneys and Counselors at Law
30800 Telegraph • Suite 2980
Bingham Farms, MI

New Year's Eve 1993

YOUR NEW YEAR'S EVE PACKAGE INCLUDES:

- ★ **Holiday Room and Dinner for Two**
Bottle Champagne in Room
Party Favors
\$119.00 Per Couple
- ★ **Non-Holiday Room, Dinner for Two**
Bottle of Champagne in Room
Party Favors
\$109.00 Per Couple

* Cancellation deadline is December 10, 1992.
* Rooms for Tuesday, Wednesday, Friday, and Saturday \$39.00 plus tax. (With purchase of New Year's Eve Evening)

New Year's Eve Recovery Brunch Available 9 a.m. - 2 p.m.

Make a "Private Party" Out of New Year's Eve

- Overnight Accommodations
- Bottle of Champagne
- Party Favors

\$59 - \$79 plus tax

CALL for reservations **(313) 728-2800**

Holiday Inn
DETROIT METRO AIRPORT
I-94 (Exit 198) at Wickham Rd. • Romulus, MI 48274

SELECT AIR SYSTEMS **459-1954** 41290 Joy Rd. Plymouth

Let Us Entertain You!
Affordable OAK Entertainment Centers for Your Audio-Visual Needs!!

Now **\$209.88**
REG. \$349
• Built-in swivel TV platform

Now **\$319.88**
REG. \$524
• Pull-out TV swivel • Storage area
• Adjustable shelves • 52x17x45"H
• Also available in cherry

Laurel FURNITURE, INC. LAY-AWAY AVAILABLE

584 W. Ann Arbor Trail • Plymouth, Michigan 48170 • 313-453-4700
Open Daily 9:30 - 6, Thurs. & Fri. 9, Sat. 10:5 - 3:30

Metro expansion, noise reduction plans outlined

BY RALPH R. ECHTINAW
STAFF WRITER

Metro Airport isn't taking over Romulus. It just looks that way.

Wayne County Executive Edward McNamara announced Friday that the county will finance a \$930-million expansion and renovation of Metro in part by bonding for \$750 million. The bonds were tentatively approved Wednesday by the county commission. The rest of the project will be paid for with money from a \$3-per-passenger tax on flights leaving Metro and money from the federal airport trust fund.

In addition, the Federal Aviation Administration recently approved a new set of airline routes for landing and taking off from Metro. The new routes, which take effect Nov. 29, will spread the arriving and departing aircraft out over a wider area than the current routes do.

So people living under the new routes will be subjected to no more than 40 takeoffs a day on an average of two days per week, deputy executive Michael Duggan said. Also, a midnight-to-6 a.m. curfew will limit takeoffs to the north to an average of two days a week during that time.

Along the same lines, the county hopes to spend \$110 million on noise reduction. Most of that is supposed to be used to buy houses or add soundproofing materials to houses in high noise areas near the airport, mainly in Romulus and Huron Township.

As for the expansion, McNamara said he believes it will "create" 20,000 area jobs by 2000, mostly because an increase in the number of Metro's international gates from six to at least 15 will be a boon to area companies that ship goods overseas.

"It's critical that Wayne County begin to develop a more efficient international terminal," McNamara said. "We can't afford to hold back when other (big airports) are building for the future. We sincerely believe that airport development promises the best possibilities for our future."

The expansion, expected to be completed in 1998, includes:

- Construction of a south access road to the airport (\$128 million).
- A new terminal located south of the existing terminal (\$662 million).
- Reconstruction of existing terminals and concourses (\$95 million).

■ A fourth runway to the west and parallel to the existing main runway (\$92 million).

County commissioner Bryan Amann, D-Canton, said he's happy about McNamara's announcement. "I view this as potentially the Fourth of July of Wayne County," he said. "It's a declaration of independence from the airlines."

Other commissioners were not so cheerful. Susan Hubbard, D-Dearborn, the chairwoman of the commission's airport noise committee, said McNamara's noise mitigation plan is inadequate. "I won't participate in their press conference until there's a noise abatement program in place," she said.

Hubbard, who has been accused of politicizing the airport noise committee's hearings so she can run for mayor of Dearborn next year, accused McNamara of expanding Metro because he wants to run for governor.

Deputy executive Michael Duggan said of Hubbard, "She has not behaved in a responsible manner. I don't think too many people will take her seriously. If she can point to one tangible thing she has accomplished, I'll pay attention to her."

BAZAARS

■ **PWP**
Crafters are needed for the Parents Without Partners Huron Valley Regional Council's Christmas in the Country craft show Nov. 27-29 at the Royce Hotel, 1-94 and Merriman Road, Romulus. For information, call 624-5981 or 464-1969.

■ **RICE MEMORIAL**
Rice Memorial United Methodist Church will hold a holiday bazaar and "cooky" walk 10 a.m. to 3 p.m. Nov. 28 in the church, 20601 Beech Daly and Eight Mile roads in Redford Township. Luncheon will be served. For information, call the church office days 534-4907 or evenings 538-6201.

■ **CIVIC LEAGUE**
The Wayne-Ford Civic League will hold an arts and crafts show 9 a.m. to 5 p.m. Nov. 28 in the Civic League, 1661 N. Wayne Road, Westland. Admission is free. Food will be available. Call 728-5010 for more information.

■ **CHRISTMAS WONDERLAND**
Lutheran High School Westland presents "A Christmas Wonderland," 10 a.m. to 5 p.m. Dec. 4 and Dec. 5 in the school, 33300 Cowan Road, one-half mile east of Westland Shopping Center. Admission is \$1.

■ **ST. JOHN'S**
St. John Episcopal Church, 574 Sheldon, Plymouth Township

will hold its annual holiday bazaar 10 a.m. to 5 p.m. Dec. 5 in the church. Some 30 areas craftspeople will have booths. Fresh greens and roping will be available. A bake sale and cafe also will be featured. Admission is \$1 or canned good for Crossroads Soup Kitchen in Detroit.

■ **ST. THOMAS A'BECKET**
St. Thomas A'Becket will hold a craft show 9 a.m. to 4 p.m. in the church, 555 S. Lilley Road, south of Cherry Hill. More than 70 crafters will be featured along with a bake sale. Admission is 50 cents for senior citizens, \$1 for others. Children under 12 are admitted free. Tables are available, call Terri at 397-5886.

Berkley Berkley Flower Shop & Greenhouse 3071 W. 12 Mile Rd. 544-4500	Livonia Flowers from Joe's 33152 W. 7 Mile 477-8616 Fresh & Silk Flowers Delivered Twice Daily	Livonia Nick Bos Florist & Greenhouse 33220 W. 7 Mile Rd. 531-1674 Serving Livonia, Farmington, Detroit and 48 Suburbs Daily	Redford Floyd's Flowers, Inc. 25096 Five Mile Open Mon.-Sat. 8 am-7:30 pm Sunday 9 am-3 pm FTD 535-4934
Birmingham Cranbrook Moss-Lipinski Flowers 2527 W. Maple 151 S. Bates 647-3949 646-7272 All Major Credit Cards FTD	Livonia French's Flowers and Gifts 33885 Five Mile in the Near Civic Center Plaza 427-7820 FTD All Major Credit Cards	Livonia Merri-Craft Florist Ask about our Thanksgiving Specials 13955 Merriman Rd. 427-1410 Teleflora	Southfield All About Flowers 26052 W. 12 Mile 350-0120 Daily Delivery, Wire Service, All Major Credit Cards
Bloomfield Hills The Bloomfield Hills Florist 1992 Woodward Ave 335-1920 All Major Credit Cards	Livonia Irish Rose Florist 33608 7 Mile Just W. of Farmington Rd. 478-5144 Wire Service • Visa • MC • Amer. Ex.	Livonia Plaza Florist and Gifts 37287 W. Six Mile 464-7272 Located in the Mini-Mall in Newburgh Plaza	Wayne Keller & Stein's Flower Shop & Greenhouse, Inc. 42158 Michigan Avenue 397-0800 Serving Wayne, Westland, Canton and 48 Suburbs Daily
Farmington Hills Hearts and Roses, Inc. 33238 W. 12 Mile • Farmington 553-7699 39050 Schoolcraft • Livonia 953-0560 AFS TELEFLORA FTD	Livonia Livonia Florist Merri-Five Plaza 422-1313 Major Credit Cards Accepted Teleflora FTD	Livonia Susie's Flowers and Gifts 37613 5 Mile Rd. 464-4588 Specializing in Old Farmington AFS Teleflora FTD	Westland Decker's Flowers & Gifts Fresh Flowers, Plants and Gift Baskets FTD 261-9080 Teleflora

Remember Flowers For ...

Thanksgiving

November 26, 1992

Most of these local florists feature one or more of the nationally known wire services

WALLSIDE WINDOWS

NO ONE GIVES YOU MORE... LET US PROVE IT!

FREE In-Home SERVICE Includes Labor & Materials For 35 YEARS

FACTORY DIRECT SAVINGS On All Our VINYL Replacement WINDOWS STARTING FROM \$199 PER WINDOW INSTALLED

NO PAYMENTS OR INTEREST TILL MARCH '93 FOR A FREE IN-HOME ESTIMATE CALL... **292-4400**

100% Financing Available (With Approved Credit) Or Call Toll Free 1-800-521-7800

WALLSIDE WINDOW FACTORY & SHOWROOM

27000 Trolley Industrial Dr., Taylor, MI 48180

Visit Our New Showroom Today!

ANNOUNCING OUR NEW 18-MONTH BONUS RATE CERTIFICATE.

8%
4%

annual interest for the first 31 days. annual interest for the remaining 17 months.

If you've been looking for a safe investment that also pays a healthy amount of interest, look no further than Standard Federal Bank. Thanks to our new 18-month bonus rate savings certificate, you really can have the best of both worlds. Interest is compounded and paid quarterly. And a minimum deposit of \$500.00 can get you started. So stop by your nearest Standard Federal Banking Center today. Then pat yourself on the back for making such a smart move.

Helping You Along The Way.

Standard Federal Bank
Savings/Financial Services
1-800/643-9600

Member FDIC Substantial interest penalty for early withdrawal from certificate accounts. Standard Federal Bank bonus compound may not be used in conjunction with this premium rate certificate account. ©1992 Standard Federal Bank.

TASTE BUDS



CHEF LARRY JANES

Save time, and money with cooking shortcuts

Fortunately, I've learned to master my use of time pretty well. Not that I'm any kind of a neurotic punctualist, but compared to some of my friends, when I say I'm going to do something at a specific time, I do it.

I leave plenty of time for travel, opting to "get there a little early rather than a little late." Same goes for cooking.

Cooking rituals

There are thousands of recipes and cooking techniques that require ample amounts of time. Many of these, like bread making for instance, are more of a ritual.

Sure, there are shortcuts to making homemade bread, things like quick rise yeast, mixers that knead and convection cooking, but when it comes to making bread I relish the sensation derived from "working with the dough."

I don't want to hurry it along. I want to smell the yeast proofing, I want to see the rising under those dishtowels, I want to savor the aroma of the baking. If you have ever made bread, you know what I'm talking about.

Cooking shortcuts

But alas, the only time I can cook like that is when I block out hours, and the only way to block out hours is to save up those minutes here and there. Sure, I use shortcuts. Why not? Especially when they are as easy as:

Why would anyone spend hours making soup stock when it can be made even better using a pressure cooker in under an hour? Furthermore, if you want soup and don't have the time to pressure cook, you just can't beat those jars of soup stock and soup base available at Kitchin Glamor, Williams-Sonoma and restaurant supply houses.

Why would anyone, short of Chef Joe Becker, the pastry prince from Schoolcraft College, want to spend the time and money to make puff pastry dough when Pepperidge Farm has a package sitting in your grocer's freezer for around \$2 that works just as well?

I keep this stuff in my freezer and use it on everything from appetizers to pasties and even Beef Wellington.

Why would anyone want to spend hours greasing and washing cookie sheets and baking dishes when you can line them with a product called parchment paper? Long a staple at bakeries, this specially treated paper can be re-used until it literally burns up.

Last year, I made about 20 dozen cookies and used the same baking pans and parchment paper. Never once greased or washed a pan. Here's something really basic — have you ever dropped an egg on the kitchen floor, and used half a roll of paper towels to "get it up?"

Did you know that covering it with table salt and allowing it to stand for three minutes will make for a one-towel cleanup?

Time savers

Not being a big promoter of processed foods, I just can't imagine why anyone, who, like me, uses garlic and anchovies only occasionally, and usually wastes more than I would ever use, hasn't discovered the chopped versions of garlic in a jar, and the tubes of anchovy and tomato puree.

My vegetable crisper drawer is beginning to look like a deli with all these time-saver tubes and jars of flavors from around the world. I can't imagine why more people don't use ground turkey products instead of ground red meats for spaghetti sauces, tacos and sloppy joes. Not only is it more healthy because of the reduction in fat, but it also costs less. When mixed into a well-seasoned sauce base, you'll be hard pressed to tell the difference between it and meat.

Party tips

Getting so close to the holidays, I can't believe it when I hear that people throwing a holiday bash get so uptight about the food, et al. The idea of having a party is to "party," so do as much as you can ahead of time, stay out of the kitchen as much as possible, and enjoy your guests.

Use the washing machine and wash tub to hold ice, beer, soft drinks, etc. Have the food spread out throughout the house rather than sequestered on one table. A card table in each corner can hold as much or more than one dining room table.

Exchange "services" with a friend or neighbor for "helping," especially with the setup and cleanup.

Best buy of the season: a tiny plastic dough scraper that can clean the frost off a windshield, scrape the crud off a frypan or clean a counter or table top without scratching.

Cost — about 89 cents available at all gourmet shops and kitchen stores.

See *Janes family-tested recipes inside*. To leave a message for Chef Larry, dial 953-2047 on a touch-tone phone, then mailbox number 1886.



Whatever you do, don't panic on Thanksgiving Day. Don't worry if you run out of something, most major grocery stores are open. Whether this is your first Thanksgiving dinner, or 10th, we've got tips to help you thaw and cook the big bird.

BY KEELY WYGONIK
STAFF WRITER

If you wake up on Thanksgiving morning to find the bird still frozen, or discover you're out of cranberry sauce, don't panic, help is on the way.

Most major Detroit area grocery stores will be open on Thanksgiving Day. Farmer Jack and A&P with the exception of the Farmer Jack store at 11 Mile and Lasher in Southfield will be open 8 a.m. to 4 p.m. Kroger stores will be open 7 a.m. to 3 p.m., and Meijer's will be open 24 hours on Thanksgiving.

On the big day, if things go wrong, the first person to call is your mother. If that fails, call one of the turkey hot lines listed above. Moms usually know the answers.

Shelia Garvey, who teaches foods at Livonia Stevenson High School in Livonia, wrote a worksheet on "How to cook a Thanksgiving dinner," after her daughter Jill, who lives in Washington, D.C., called in a panic.

Step by step, she explains how to

buy and cook a turkey. Here's a quick lesson for new cooks. Seasoned cooks should think of it as a review.

According to Garvey, "turkeys are available in either the fresh or frozen state, and there is a noticeable flavor difference and cooking time difference between the two."

"Fresh turkeys are more moist, richer flavored, and make a darker and more rich gravy. If a fresh turkey has been purchased, follow the cooking directions which accompany the bird for roasting times."

Thawing turkey

"Frozen birds require thawing which should be done in the refrigerator a couple of days in advance. Thawing on the counter can be dangerous because of bacteria which accumulates on the skin and in the carcass as the turkey thaws. After the thawing, the bird should be washed inside and out and the bag of giblets inside the rear of the carcass should be removed."

To thaw the bird inside the refrigerator, "place the still-wrapped turkey, breast up, on a shallow tray and slide it onto a refrigerator shelf," recommends the Butterball Turkey Company in their newly published "Butterball Turkey Cookbook," (Hearst Books, New York 1992, \$12.95).

"The tray, which may be any rimmed, flat pan such as a jelly-roll or roasting pan, catches juices which may leak from the wrapper as the bird thaws." (See chart for times).

If you forget to take the turkey out of the freezer, don't panic. "To defrost the bird quickly, plan on about 30 minutes per pound," said Lois Thieleke, home economist for the Oakland County Cooperative Extension Service.

Leave the bird in the original unopened bag in the sink with cold water. Change the cold water every 30 minutes to ensure safe, but effective thawing. Refrigerator thawing is the most preferred method for safety reasons. (See chart for times).

To thaw a turkey in a microwave oven, check manufacturer's instruction for the size turkey that will fit in your oven, the minutes per pound,

See PANIC, 2B

TURKEY TIPS:

T H A W I N G

(Whole turkeys, frozen and unstuffed)

In the refrigerator

8 to 12 pounds - 1 to 2 days
12 to 16 pounds - 2 to 3 days
16 to 20 pounds - 3 to 4 days
20 to 24 pounds - 4 to 5 days

In cold water

8 to 12 pounds - 4 to 6 hours
12 to 16 pounds - 6 to 9 hours
16 to 20 pounds - 9 to 11 hours
20 to 24 pounds - 11 to 12 hours

In a microwave

50% power - 4 to 6 (minutes/pound)
30% power - 6 to 8 (minutes/pound)

After thawing, remove neck and giblets, wash turkey inside and out with cold water, drain well.

H O T L I N E S

(Turkey trouble-shooters)

Oakland Co. Food Hotline: 858-0904
(M-F, 8:30 a.m. to 5 p.m.)
Wayne Co. Food Hotline: 494-3013
(M-F, 8:30 a.m. to 5 p.m.)
U.S.D.A. Meat & Poultry Hotline:
(800)535-4555
Butterball Turkey Talk-Line:
(800)323-4848
Land O' Lakes Holiday Bake-Line:
(800)782-9606

Turkey pie makes leftovers 'fowl'-filling

WINNER DINNER



BETSY BRETHEN

It is no wonder that many cooks cry "fowl" the day after Thanksgiving while looking at the assortment of remaining leftovers.

After spending hours shopping for the food, followed by the logistical challenge of preparing it, somehow the joy of eating Thanksgiving dinner is shortlived, especially knowing full well that the momentous job of cleaning up and putting away is yet to come.

This week's Winner Dinner, submitted by Ellen Kittendorf, will help you deal effectively and deliciously with the plastic bags and containers filled with leftovers that threaten to take over the refrigerator.

Featuring recipes for turkey and stuffing pie, and a gelatin salad that makes use of cranberry relish, this meal can be accompanied with leftover mashed potatoes and rolls, and polished off with pumpkin or minced meat pie.

Kittendorf is a resident of Troy and works in the General Motors building as a secretary in the Credit Analysis Department for GMAC. She loves to travel and met her husband of eight years, Roland, in a restaurant in Ja-



JIM RIDER/STAFF PHOTOGRAPHER

Winner Dinner: Ellen Kittendorf's turkey and stuffing pie is a delicious way to recycle leftovers.

pan where they wound up sharing a table. Love blossomed and within six months of meeting, they were married. Together they have traveled all over the world as one of his job re-

See TURKEY, 2B

OBSERVER & ECCENTRIC

Winner Dinner Recipes



TURKEY AND STUFFING PIE CRUST

Either 3 cups leftover stuffing

or:

- 1 stick butter or margarine
- 1 1/4 cups boiling water
- 3 1/2 cups seasoned stuffing
- Filling
- 1 can (2.8 ounces) French fried onions
- 1 can (10 1/2 ounces) cream of chicken soup
- 3/4 cup milk
- 1 1/2 cups (7 ounces) cooked turkey, cubed
- 1 package (10 ounces) frozen peas, thawed

Preheat the oven to 350 degrees. If leftover stuffing is being used, combine it with half of the can of onions and toss lightly to mix.

If stuffing is being prepared, follow these directions.

Heat butter and water until the butter has melted. Add the stuffing and toss lightly until the stuffing is moistened. Stir in half of the can of onions.

Spoon the stuffing into a 9-inch pie plate, pressing it onto the bottom and up the sides to form a shell.

In a bowl, combine the soup, milk, turkey and peas; pour this mixture into the shell.

Cover with foil and bake for 30 minutes at 350 degrees.

Top with remaining onions and bake uncovered for 5 minutes longer. 4-6 portions.

CRANBERRY GELATIN SALAD

3 ounce package raspberry gelatin
1 can (15 ounces) cranberry relish

Follow the package directions to make the gelatin. Add the cranberry relish and chill until set.

Serve on a bed of lettuce. This recipe offers a delicious way to make use of leftover cranberry relish.

Recommended wines have easy to swallow prices

We can truly say this column is a response to consumer demand. Your calls to our voice mailbox requested wine recommendations for the Thanksgiving Feast this coming Thursday.

Since you didn't give us a clue about what you wanted to spend, we're offering selections at \$10 and less, and then some pricier ultra-premium bottlings. Because many wine shops have holiday wine sales in progress, you may find recommended wines even cheaper than the price we give.

The Associated Food Dealers of Michigan report that although budgets may be tight currently, it won't cost as much to loosen our belts after a big Thanksgiving dinner this year.

According to the AFD, the price to buy and prepare a traditional turkey dinner has gone down over the last two years. The AFD esti-

FOCUS ON WINE



ELEANOR & RAY HEALD

mates that the cost including turkey and all the traditional trimmings — stuffing, mashed potatoes, gravy, yams, cranberry sauce, rolls, pumpkin pie and even wine! — averages approximately \$3.45 per person at a table for 10.

If your budget allows a higher average, then sample some of the premium pours recommended.

The veritable treasure trove of food flavors finding their way to the Thanksgiving dinner plate are

Wine Bulletin Board

If winter's already given you the chill, attend Southern Exposure, a walk-about tasting of wines from Australia, New Zealand, South Africa, Chile and Argentina sponsored by the

Beverage Warehouse at Farina's Banquet Center (Coolidge & 11 1/4 Mile Road), Berkley, 7-9:30 p.m. Thursday, Dec. 3 for \$15 per person. For reservations, call the Beverage Warehouse at 644-2155 or 258-9797 by Nov. 27.

well complemented by an equal bounty of flavorful wines.

Chardonnay, America's favorite white wine, is well suited to the holiday feast. Oakier, more complex styles are not overwhelmed by seasonings in the dressing or gravy. They aren't beat up on the palate by sweet potatoes or cranberries. Oranges in a cranberry relish actually showcase the bright tropical fruit of several California chardonnays. These oakier styles cost more to produce and the price quickly escalates over \$10.

Heading the list of values in the chardonnay category are the 1991 Santa Monica from Chile (\$7), Barton & Guestier Saint Louis from France's Macon region (\$8), and 1991 Rodney Strong, Sonoma County (\$10).

Australian producers were the first to blend semillon and chardonnay to create "semchards." The idea caught on in California and one of the best semchards is the 1991 Lockwood (\$9).

Between \$10 and \$15, we highly recommend these chardonnays:

1991 Chateau Souverain, Sonoma; 1991 J. Lohr Riverstone; and 1991 Kendall-Jackson Camelot Vineyard. Michigan native Fred Fisher, owner of Fisher Vineyards in the Sonoma Valley, has always had a big following for his wines in our state. His 1990 Fisher Coach Insignia Chardonnay (\$15) is the best he's produced to date. Its broad flavor intensity stems from about 10 percent naturally fermented lots in the blend.

Exceptionally flavorful is the 1990 Fetzer Reserve Chardonnay (\$18.50). The 1990 Robert Sinskey Vineyards Carneros Reserve Chardonnay (\$28) is a knockout with buttery richness and harmonious flavors.

Fruity red wines are well-paired to turkey, especially the juicier, darker meat. Before French Beaujolais Nouveau prices went

through the roof, we always recommended them. Today, they are not worth the money. California gamays have taken up the slack and are delicious. The best this year are the 1992 Beringer Nouveau Gamay Beaujolais and the 1992 Preston Vineyards Gamay Beaujolais at around \$7.50 each.

Merlots also match well with darker turkey meat. They have less overt fruitiness than a gamay and are more complex. Their soft finish works well against potatoes, gravy and dressing. We like the following merlots: 1990 Round Hill (\$7.50); 1990 Chateau Souverain (\$10); 1990 Kendall-Jackson Vintner's Reserve (\$14); and 1990 Merryvale (\$18).

To leave a message for wine columnists Ray and Eleanor Heald, dial 953-2047 on your touchtone phone, mailbox number 1864.

Shortcut appetizers, broth easy

See Larry Janes' column on Taste front.

SAUSAGE APPETIZERS

- 1 pound packaged puff pastry dough
- 1/2 pound smoked kielbasa or sausage
- 4 tablespoons fancy mustard (i.e. honey mustard, dijon, etc)
- 1 egg white

Defrost frozen puff pastry. Open sheets and cut into 2-inch by 2-inch squares. Cut a small slice of kielbasa and place on each square. Top with a tiny dollop of fancy mustard. Bring ends together to wrap sausage and place seam down on a baking sheet covered with parchment paper. Brush with egg whites and bake at 350 degrees for 10-12 minutes or until golden. Serve warm.

BASIC BEEF STOCK PRESSURE COOKER VERSION

- 1/4 cup olive oil
- 2 carrots diced
- 2 ribs celery, diced
- 2 medium onions, chopped
- 3 pounds meaty beef bones, split by butcher
- 1 cup dry white wine
- 3 cloves garlic, mashed
- 1 teaspoon thyme
- 1/2 teaspoon tarragon
- 2 bay leaves
- 3 large sprigs parsley
- 1 teaspoon peppercorns, fresh ground
- 2 teaspoons salt or to taste
- 10 cups water

Preheat oven to 425 degrees. Combine oil with vegetables, stirring to coat. Add meat bones.

Bake, stirring frequently for 25 minutes or until vegetables and bones are a deep golden brown. Scrape vegetables and bones into a pressure cooker. Place baking dish over medium heat and add wine. Scrape to dislodge particles and deglaze the baking dish.

Pour into pressure cooker. Add garlic seasonings and water. Secure lid. Develop pressure over high heat, reduce heat to medium low and cook for 60 minutes. Release steam according to manufacturer's directions. Remove lid and mix well. Strain stock and press vegetable pulp through a strainer if desired. Remove meat from bones and add to stock.

Source — "The Joys of Pressure Cooking" by Toulia Patsalis, (Copyright 1990 Kitchen Glamor Inc.)

Panic from page 1B

and the power level to use for thawing. "The Microwave Cook's Complete Companion," Rosemary Dunn Stancil and Lorella Nichols Wilkins, (Fawcett Columbine, New York, 1990, \$24.95) says to "leave the turkey in the original wrapper, and place it in a casserole to catch any liquid."

"Begin defrosting with the breast side up, turn turkey over midway through defrosting. The bird should still be icy in the center when it is removed from the microwave. Complete the thawing by immersing the bird in cold water." (See chart for times).

Cooking times

Back to the bird. "The interior of the bird should be lightly salted, just before cooking, and it is at this time that the bird should be stuffed with dressing," said Garvey. "Never stuff a turkey the night before to save time in the morning, and never keep the stuffing in the carcass and spoon it out later as leftovers."

The stuffing must come out of the bird right after the meal. If these sanitary procedures are not followed, salmonella or food poisoning can occur.

If you want to save time stuffing the bird, June Dugar of Livonia

has a tip that works like a charm. "Make the stuffing the night before and put it in a bread wrapper. Put the open end of the bag in the turkey, and push the stuffing in," said Dugar.

"After stuffing the interior of the bird, bind or truss the bird's carcass closed with a pre-purchased set of pins and string or use string and nails to wrap the opening tightly," said Garvey.

Place the turkey breast-side up in a shallow roasting pan. Cover turkey loosely with aluminum foil. Remove foil 20 to 30 minutes before roasting is finished to allow the bird to brown. Preheat the oven to 325 degrees. Bake immediately. Figure 15-18 minutes per pound for an unstuffed bird, and 18-24 minutes per pound for a stuffed bird. Baste it occasionally, too.

Thieleke said the turkey is done when the meat thermometer registers 180 degrees, the juices run clear, and the legs wiggle in the sockets. A turkey breast is done when the thermometer registers 170 degrees. Stuffing tem-

perature should be at least 165 degrees. Allow the cooked turkey to sit 20 minutes before carving.

Here are some time-savers from "Food News For Consumers/Holidays 1992" — Save 30 to 60 minutes of roasting time by using an oven cooking bag. Actual time saved depends on the size of your turkey.

Save two hours by baking your stuffing in a separate pan. A 20-pound unstuffed bird cooks in about 4 1/2 hours versus 6 1/2 hours if stuffed.

Halve your cooking time (oven space permitting) with two 10-pound unstuffed birds versus one stuffed 20-pounder. Cuts cooking time from 6 1/2 to 3 1/2 hours.

Refrigerate leftovers. Never leave perishable foods at room temperature over two hours. Thieleke recommends removing all meat from the carcass and storing in small shallow containers so they cook faster. Use leftover turkey within three to four days, gravy within one to two days, or freeze all or any of these.

FOOD STAMPS WELCOME

The FRESH CHOICE

PRODUCE MEAT AND DELI!

19330 Middlebelt ~ Livonia

1 Block N. of 7 Mile Next to Kids-R-Us. Across from Sears, Livonia Mall

Store Hours:
Mon.-Sat. 9 a.m. - 8 p.m.
Sunday 9 a.m. - 5 p.m.

WE ACCEPT FOOD STAMPS
We Sell USDA Western
Grain Fed Beef
Our Own Oven Fresh Bakery

Del. Dept. Fresh Seafood
Fresh Cut Flowers
and Indoor Plants
Fresh Produce Daily

Sale Mon., Nov. 23 - Sun., Nov. 29, 1992

U.S.D.A. Choice
5 to 7 Rib
Standing
Rib Roast
\$2⁹⁹ LB.

From the Farm
FRESH TURKEYS
99¢ LB.

Boneless
Rolled
Center-Cut
Pork Loin Roast
\$2⁸⁸ LB.

LARGE
SHELL-ON
SHRIMP... \$5⁹⁹ LB.

Melody Farms
FRESH
EGG NOG
Quart Carton
99¢

FREE

TURKEY

Grade A Fresh Frozen Turkey
(8 to 10 lb. average) **FREE** with
additional \$50.00 purchase or more.
Limit 1 turkey per family please.

Fresh Crisp
CALIFORNIA
CELERY
stalk
47¢

Fresh Baked
PUMPKIN PIES
3 pounds - 10 inch
\$3⁹⁹ each

FRESH WHOLE
CRANBERRIES
\$1⁴⁹ 12 oz. package

New Crop
California
SEEDLESS
NAVAL 12/99¢
ORANGES

place your order now

Turkey

from page 1B

responsibilities is to set up, and escort many of the tours that are organized by the travel department of the Birmingham Community House.

A 10-year member of the First Presbyterian Church of Dearborn choir, Kittendorf has recently become involved with the Detroit Literacy Volunteers of America. She also worked on a crisis hot line for 10 years in Detroit, and was a member of the board of directors of Contact Lifeline for seven years.

In the spirit of the season, thanks are given to you, Ellen Kittendorf, for sharing your recipes and best wishes are extended to all for a happy and "fowl"-filling Thanksgiving.

Submit recipes to be considered for publication in this column, or elsewhere, to: Winner Dinner, P.O. Box 3503, Birmingham, Mich. 48012. All winners receive an apron with the words "Winner Dinner Winner" printed on it. To leave a message, dial 953-2047 on a touchtone phone, mailbox number 1851.

Bob's Farm Market

421-0710
31210 WEST WARREN
Corner of Warren & Merriman - Merri-Warren Shopping Center

YOUR LOCAL FRESH MEAT - SEAFOOD - DELI - FRUIT & VEGETABLE STORE

Ground Fresh Many Times Daily
Our Super Lean Hamburger From
GROUND SIRLOIN \$1.59 LB.
5 LB. PKG.
OR MORE Limit 10 Lbs.

Cooked & Clean
COCKTAIL SHRIMP \$7.99 LB.
Limit 3 Lbs.

Western Grain Fed Beef - Limit 10 lbs.
PORTER HOUSE or T-BONE STEAKS ... \$3.69 LB.

Grade A Fresh - BONELESS - Limit 10 Lbs.
BUTTERFLY PORK CHOPS..... \$2.69 LB.

Kowalski - Limit 3 Lbs.
SKINLESS FRANKS..... \$1.89 LB.

Michigan "All Purpose" 10 Lb. Bag - Limit 1
WASHED POTATOES..... 89¢

Western Grain Fed Beef - WHOLE - BONELESS
WHOLE TOP SIRLOIN
\$1.69 LB.
Limit 1 - Sliced into Steaks
Free. Wrapped in 1 Pkg. Only.

Domestic - Limit 3 Lbs.
BOILED HAM \$1.59 LB.

Dairy Fresh - Limit 3 Lbs.
YELLOW AMERICAN CHEESE..... \$1.79 LB.

LOWENBRAU
12 Pack Bottles \$5.99 + Dep.
-2.00 Mail-in Rebate
FINAL COST AFTER REBATE \$3.99 + Dep.

Grade A
BABY BACK SPARE RIBS
\$1.99 LB.
Limit 5 Lbs.

Smoked - Sliced
PLATTER BACON 88¢ LB.
Limit 5 Lbs.

Regular - Diet - or Cranberry
2 Liter Plastic
CANADA DRY 89¢ + Dep.

California - Natural - Limit 3 Lbs.
PISTACHIOS \$2.69 LB.

Grandma Shearer Assorted Varieties
11 oz. Bag - Limit 4 Bags
POTATO CHIPS \$1.39

We accept Personal Checks, Mfgs. Coupons and Food Stamps
We Reserve the Right to Limit Quantities - All Sales Items Available While Supplies Last

Brownie cookbook satisfies cravings for something sweet

BY BETH SUNDRLA
STAFF WRITER

Nice and easy. Some foods have a casual air, like those eaten at a backyard barbecue or at a picnic in the park. In the winter those events are just a memory in Michigan.

But here you are with a cold November in your soul, and you want something sweet to eat on a dreary night that doesn't seem much good for anything else. It doesn't get much more casual than this. A brownie would probably hit the spot.

"Brownies and Blondies," by Lisa Yockelson, the first in a series called American Baking Classics, was published in 1992 by HarperCollins Inc. and offers a variety of recipes for brownies and their lighter-colored cousin blondies.

"Brownies hold a time-honored place at charity bake sales, in the holiday cookie tin, heaped on a plate as an after school treat, or as

a casual dessert, simply cut from the baking dish and served forth plain or with a scoop of ice cream," Yockelson writes in the introduction.

The basic ingredients of butter, eggs, sugar, and flour figure into all these recipes. Then comes the time to make choices. Will it be Classic Cake Brownies or a variation: Deep Dish Fudge Brownies, Black Bottom Brownies or Rocky

Road Brownies? How about Classic Blondies or Oatmeal and Peanut Butter Blondies or Coconut Blondies?

While the recipes are for the most part simple, they require the dirtying of a lot of dishes — a bowl for the dry ingredients, another for the moist ingredients, a container for the melted chocolate, one for melted butter and still another to toss the chocolate

chips with a teaspoon of the flour mixture.

Blondies mixed up quickly and smelled great while baking. The result: a moist, cream-colored snack that tastes of brown sugar, butter and vanilla.

The 101-page book also includes tips for baking, cutting, storing and freezing the brownies. It's \$12.50.

Marbled pumpkin cheesecake elegant

AP — For an elegant Thanksgiving dessert, serve Marbled Pumpkin Cheesecake. The cheesecake is swirled with the richness of chocolate. Canned pumpkin adds flavor and moistness.

MARBLED PUMPKIN CHEESECAKE

- 1 1/4 cups graham cracker crumbs
- 2 tablespoons granulated sugar
- 1/4 cup butter or margarine, melted
- 2 cups (12-ounce package) miniature semisweet chocolate chips
- Three 8-ounce packages cream cheese, softened
- 1 cup granulated sugar
- 1/4 cup packed light brown sugar
- 1 3/4 cups (16-ounce can) solid pack pumpkin
- 4 eggs
- 1/2 cup undiluted evaporated milk

- 1/4 cup cornstarch
- 1/4 teaspoon cinnamon
- 1/4 teaspoon nutmeg

For the crust: In a medium bowl, combine graham cracker crumbs, sugar and butter. Press onto bottom of greased 10-inch springform pan; sprinkle with 1 cup chocolate chips.

For the cheesecake: In a small, heavy saucepan over low heat, melt remaining 1 cup chocolate chips, stirring constantly until smooth. In large mixer bowl, beat cream cheese, granulated sugar and brown sugar. Beat in pumpkin. Beat in eggs and evaporated milk. Beat in cornstarch, cinnamon and nutmeg. Remove 1 cup pumpkin batter; stir into melted chocolate. Pour pumpkin mixture into crust. Spoon chocolate mixture over top; swirl. Bake in a preheated 325-degree F oven for 60 minutes or until edge of filling is set. Turn oven off. Allow cheesecake to stand in oven for 30 minutes. Remove from oven. Cool completely. Cover, chill for several hours. Makes 12 to 16 servings.

Recipe from: Nestle Food Co.

Brownies and blondies warm up dreary nights

BLACK BOTTOM BROWNIES

- 3/4 cup unsifted all-purpose flour
- 1/4 teaspoon baking powder
- 1/4 teaspoon salt
- 8 Tablespoons (1 stick) unsalted butter, melted and cooled
- 3 squares (3 ounces) unsweetened chocolate, melted and cooled
- 1 cup superfine sugar
- 2 extra-large eggs
- 1 extra-large egg yolk
- 2 teaspoons vanilla extract

Preheat oven to 350 degrees. Butter and flour a 9-by-9-by-2-inch baking pan.

For the brownies, thoroughly mix the all-purpose flour, baking powder and salt. Set aside 2 teaspoons of the flour mixture for the cream cheese topping (recipe below).

Whisk the butter and chocolate in a bowl; beat in the sugar, eggs, egg yolk and vanilla extract. Add the dry ingredients and stir to form a batter.

Pour and scrape the batter into the prepared pan; spread the batter evenly.

CREAM-CHEESE TOPPING

- 2 3-ounce packages cream cheese, softened
- 1/4 cup granulated sugar
- Pinch of salt
- 1 extra-large egg
- 1/4 teaspoon vanilla extract
- 1/2 cup miniature semisweet chocolate chips

Beat the cream cheese, sugar and salt in a bowl on moderate speed for 2 minutes. Add the egg and vanilla extract and beat for 1 minute. Toss the chocolate chips with the reserved 2 teaspoons of dry ingredients from the brownie recipe above, and stir into the cream cheese mixture. Pour the topping over the brownie batter; gently swirl the cream cheese mixture into the chocolate batter using a table knife and small spatula. Bake the brownies for 30 to 32 minutes, or until just set.

Cool the brownies completely in the pan on a rack. Cut into 2 1/4-by-

2 1/4-inch squares. Remove the brownies from the pan using a metal spatula. Refrigerate in an airtight tin.

OATMEAL AND PEANUT BUTTER BLONDIES

- 1 1/4 cups unsifted all-purpose flour
- 3/4 teaspoon baking soda
- 1/4 teaspoon salt
- 1/2 teaspoon freshly grated nutmeg
- 8 Tablespoons (1 stick) unsalted butter, melted and cooled
- 1 Tablespoon shortening, melted and cooled
- 3/4 cup light brown sugar
- 1/2 cup granulated sugar
- 3/4 cup creamy peanut butter
- 3 Tablespoons milk
- 2 extra-large eggs
- 1 teaspoon vanilla extract
- 1 cup "quick-cooking" (not instant) oatmeal

- 1/2 cup sweetened flaked coconut

Preheat oven to 350 degrees. Butter and flour a 9-by-9-by-2-inch baking pan.

Thoroughly mix the all-purpose flour, baking soda, salt and nutmeg. Whisk the butter, shortening, brown sugar and granulated sugar in a bowl; add the peanut butter and beat for 2 minutes. Blend in the milk. Beat in the eggs, one at a time, beating well after each addition; blend in the vanilla extract. Add the dry ingredients, oatmeal and coconut and stir.

Pour and scrape the batter into the prepared pan; spread the batter evenly. Bake the blondies for 30 minutes, or until just set.

Cool the blondies completely in the pan on a rack. Cut into 2 1/4-by-2 1/4-inch squares. Remove the blondies from the pan using a metal spatula. Store in an airtight tin.

Baking questions answered

AP — During this busy season of holiday baking and candy making, the Better Homes and Gardens test kitchen fields an avalanche of questions from readers. Here are some answers to those frequently asked baking questions.

Question: When should flour be sifted?

Answer: All-purpose flour is already pre-sifted so you do not need to sift it again. However, before you measure it, stir it with a spoon to make sure it's not packed down. Then spoon it into the measuring cup without packing it. Cake flour, on the other hand, does need sifting.

Question: If I'm off on measuring just a little bit, does it matter?

Answer: It is very important to measure accurately for baking. Too much flour, milk, sugar, or leavening can ruin a good recipe.

To measure liquids, use a standard glass or clear plastic measuring cup. Place it on a level surface and keep your eye level with the mark you wish to read. Fill the cup to the mark. Don't lift the cup off the counter; your hand is not as steady as the counter.

To measure dry ingredients, use a measuring cup that is the exact capacity you need. (Don't use a glass measuring cup.) Lightly spoon the ingredient into the cup. Use a metal spatula or the straight side of a kitchen knife to level. Do not pack any dry ingredients except brown sugar. Brown sugar should be packed enough to hold the shape of the measure when turned out.

Question: When I'm using my electric mixer, I never know which speed to use. What's the rule?

Answer: For cookies, beat fat (shortening, margarine, or butter) on medium speed about 30 seconds to soften. Using high speed may sling the margarine out of the bowl. Low speed can burn out the motor.

For stiff doughs, beat in flour on low speed.

For meringues and egg yolks, beat on high speed.

For whipping cream, beat on low or medium speed.

For mixtures that may splash, use low speed.

Question: Why is the dough for my sugar cookies too soft to roll out and cut into shapes?

Answer: Dough made with butter makes the stiffest dough. Cookie dough made with margarine, especially corn oil margarine, needs more chilling or freezing time before it's firm enough to roll and cut into shapes for sugar cookies. Because soft or diet margarine and spreads create a softer dough and makes tougher, drier cookies, do not use them for baking unless the recipe so specifies.

Question: Some recipes never tell me to preheat the oven. Is it necessary?

Answer: For baking, it is important to heat the oven about 10 minutes before baking to get the proper rising and even doneness. Because the top element is on

during the preheating period, baked goods can overbrown. Cake tops may set and crack as cakes rise.

Question: How do I know when breads, cakes and cookies are done?

Answer: Set the kitchen timer. Check for doneness at the minimum baking time given in the recipe. For yeast breads, the crust should be brown and the loaf should sound hollow when you tap the top. For cakes, insert a wooden toothpick near the center. When it comes out clean (without batter on it), the cake is done.



Run the Jingle Bell

10 A.M.
Sunday, Dec. 6
at
Oakland University

A Fun, Festive
5K Run and Walk

Guaranteed to Put You
in the Holiday Spirit

INFORMATION HOTLINE
350-3030

Carrier
We're The Inside Guys



Erv Ehlers Company

Our 31st Year • Unlimited License and Insured

\$200 CASH REBATE
Direct From Carrier

10 Year Parts Warranty On Model 38TR Air Conditioner

\$50 GIFT CERTIFICATE
FROM THE RESTAURANT OF YOUR CHOICE
With Act Expires 12-31-92

up to **\$500 CASH REBATE**
Direct From Carrier & Utility

10 Year Parts Warranty On Model 585XB Furnace

FREE NO-OBLIGATION ESTIMATE!

30885 Eight Mile Road • Livonia
CALL TODAY 442-8500

NOVEMBER

	23	24	25	26	27	28
29						

Stan's Markets

2 CONVENIENT LOCATIONS:

38000 ANN ARBOR ROAD 5 MILE & FARMINGTON
LIVONIA - PH. 464-0330 LIVONIA - PH. 261-6565

COUPON POLICY
Good Thru 11-29-92
TRIPLE COUPONS
UP TO **35¢**
DOUBLE COUPONS
UP TO **\$1.00**

Folgers Coffee
16 oz. A.D.C. or E.P.
\$2.89

Penn Dutch Mushrooms
4 oz. can
2/\$1.00

Quaker Oaks
Regular or Quick
\$1.39 lb.

Big Chief Sugar
4 lb. bag
99¢

DAIRY

Minute Maid Orange Juice
64 oz.
\$1.49

Grade A (10-25 lbs.)
FRESH TURKEYS

only **89¢**

Order Your Fresh Turkey Today!

FREE FIXIN'S only at Stan's

Buy a Fresh Turkey from Stan's Meat & Receive the following Thanksgiving Fixin's \$10.00 Value Absolutely FREE!

- 6 oz. Stovetop
- 3 oz. Strawberry Jello
- 16 oz. Libby Pumpkin
- 12 oz. Can Carnation Evap. Milk
- 12 ct. Bonnie Dinner Rolls
- 16 oz. Can Cranberry Sauce
- 5 lb. Bag Potatoes
- 1 lb. Margarine
- 8 oz. Whip Topping

Good Thru 11-25-92

Libby Pumpkin
16 oz. can
69¢

Bruce's Yams
40 oz. can
99¢

Stove-Top Stuffing
6 oz. Assorted Varieties
\$1.19

Boneless • Rolled
RUMP ROAST
\$2.44 lb.

Boneless
SIRLOIN TIP ROAST
\$2.58 lb.

Grade A Self-Basting • Frozen
SPARTAN TURKEYS
Only **79¢** lb.

Grade A • Self-Basting • Frozen
BUTTERBALL TURKEYS
Only **99¢** lb.

BONUS COUPON

SPARTAN LARGE EGGS
LIMIT 1 WITH \$10.00 PURCHASE
48¢ doz.

U.S.D.A. Special Trim Boneless
N.Y. STRIP STEAK
\$3.99 lb.

Armour • All Meat
HOT DOGS and SLICED BACON
99¢ lb.

Good Thru 11-29-92

Coke
2 Liter Bottles Assorted Varieties
89¢

FROZEN

Birdseye Cool Whip
8 oz.
89¢

Deli celebrates anniversary



KEELY WYGONIK

I admit it, I'm spoiled. Growing up, and living in a Polish neighborhood does that to you. There's a bakery a few blocks away from my house where you can buy freshly baked bread and pastries, and a Kowalski deli that sells kielbasa, luncheon meats, and cheese.

When I became Taste and Entertainment editor, one of the first questions I asked was — "Where are the bakeries?"

It's taking me awhile, but I am discovering them. One of my recent discoveries is Kowalski's Tasty Tray Deli at 204 S. Wayne Road at Cherry Hill in Westland.

Leonard Michalowski and his wife, Linda of Westland, recently moved their store from Venoy and Palmer, where they were for 29 years, to the present location. In October, the store celebrated its 30th anniversary. You'll always see Leonard or Linda behind the counter, or Paige Bellenir of Westland, who has worked at the deli for four years. Sometimes Michalowski's parents Helen and Walter help out too.

Store hours are 9 a.m. to 7 p.m. Monday through Saturday. They are closed on Sundays. For information, call 721-4880.

The store is immaculate. The bakery display cases are filled with freshly baked goods from one of my favorite Polish bakeries — Chene Modern Bakery on Warren in Detroit.

Baked goods are delivered fresh every morning from Chene Modern Bakery. Tasty Tray has all your favorites — angel wings, eclairs, strudels, almond and poppyseed rolls. If you need a decorated cake for a special occasion, they can accommodate you.

Tasty Tray sells only Kowalski products. "Kowalski is made in Michigan, and they follow strict standards," said Michalowski.

Kowalski Sausage Company is



GUY WARREN/STAFF PHOTOGRAPHER

Tasty Tray: Leonard and Linda Michalowski offer lots of freshly baked cakes, pastries and bread, at Kowalski's Tasty Tray deli in Westland.

also special because Michalowski's father, Walter, who ran the store with his wife Helen, before he took over 10 years ago, used to work there.

Tasty Tray also sells sandwiches, potato salad, coleslaw and pasta salad, Grandma K's Spiral Sliced ham, hunter's sausage, and kosher corned beef.

They carry some specialty items like stuffed cabbage, imported dried Polish mushrooms, and pierogi — sauerkraut potato,

cheese, plum and mushroom. Michalowski says his lunchmeat prices are 50 cents to \$1.75 per pound less than chain stores.

On the shelves are bottles of Michigan made Red Pelican mustard, Kluski noodles, and imported Krakus products like pickles, horseradish and beets. Tasty Tray also sells beer, pop and wine coolers.

To leave a message for Keely Wygonik, Taste/Entertainment editor, call 953-2105.

Slash the fat in Swiss steak by half

AP — We've slashed the fat in Swiss steak by half! How did we do it? We skipped coating the meat in flour first, so it absorbs less fat. Then we browned the meat in a pan sprayed with non-stick coating. Rather than using the pan drippings for the sauce, we wiped the pan clean and started from scratch.

SWISS STEAK

1 pound boneless beef round steak, cut 3½-inch thick
Non-stick spray coating
One 28-ounce can tomatoes, cut up
1 small onion, sliced and sepa-

rated into rings
½ cup sliced celery
1 bay leaf
1½ teaspoons dried marjoram, crushed
¼ teaspoon salt
½ teaspoon pepper
1 tablespoon cornstarch
1 tablespoon cold water
2 cups hot cooked rice or fettuccine

Trim fat from steak. Cut into 4 serving-size pieces. Spray a cold 12-inch skillet with non-stick coating. Preheat skillet over medium heat. Brown steak on both sides; remove from skillet. Wipe skillet with paper towels.

Return steak to skillet. Add undrained tomatoes, onion, celery, bay leaf, marjoram, salt and pepper. Bring to boiling; reduce heat. Simmer, covered, about 1½ hours or until meat is tender. Remove meat from skillet; keep warm. Discard bay leaf. Skim off any fat.

For sauce, mix cornstarch and water; stir into tomato mixture. Cook and stir until thickened and bubbly. Cook and stir for 2 minutes more. Serve meat and sauce over rice or fettuccine. Makes 4 servings.

Nutrition information per serving:
357 cal., 9 g fat, 31 g pro., 37 g carb., 513 mg sodium, 797 mg potassium.

COOKING CALENDAR

Send items for publication in Cooking Calendar to Keely Wygonik, Taste editor, the Observer & Eccentric, 36251 Schoolcraft Road, Livonia, MI 48150.

Kitchen Glamor
Hanukkah Celebration with Chef Elwin Greewald 1 p.m. Sunday, Dec. 6 at West Bloomfield store. Call 537-1300 for class information.

MADRIGAL DINNER
Enjoy a traditional old England yuletide feast at the 16th annual Madrigal Dinner at Schoolcraft College in Livonia. Tickets are \$30 per person. For information, call 462-4417. Dates are — 7:30 p.m. Thursday, Dec. 10, Friday, Dec. 11 and Saturday, Dec. 11.

RECIPE CONTEST
If your beef recipes lean toward delicious, you could win \$500

worth of Laura's Lean Beef. That's the grand prize in the "Wok It, Roll It" recipe contest. Entries will be accepted in three categories — ground beef, steaks and round cuts. To enter, look for entry blanks in area stores, or send your recipe on a 3 by 5 index card, with your name, address and phone number to: Recipe Contest, Laura's Lean Beef, Box 4112, Winchester, KY 40392.

Holiday Depression

Coping with a Loss During the Holidays

presented by

Mary MacGregor

Director of Community Education, Angela Hospice Home Care

and

Amy Hernandez, B.S.N., R.N.C.

St. Mary Hospital Day Treatment Program

Do you get the "holiday blues?" You're not alone. At this busy time of year, a loss, whether it be the death of a loved one, a job, divorce, change of health, retirement, or change in body, often has a greater effect on our lives. Join these two health care professionals as they discuss coping mechanisms and strategies for dealing with a loss during the holiday season.



Thursday, December 10, 1992
7 to 9 p.m.

St. Mary Hospital Auditorium

36475 Five Mile Road (use Five Mile Rd. entrance)
Livonia



Reservations requested by
Monday, December 7
591-2913

Free of charge • Refreshments served

Marian Women's Center Educational Program
St. Mary Hospital, Livonia



THE GEORGE BURNS THEATRE OF LIVONIA PRESENTS

BLACKSTONE

THE MAGICIAN

MATINEE BENEFIT PERFORMANCE • SATURDAY, DECEMBER 12, 1992 • 2:00 P.M.

A portion of the ticket proceeds will benefit the Livonia Family Y's "INVEST IN YOUTH" campaign. "Invest in Youth" is a fund that supports the youth programs at the "Y". This fund aids any child who needs financial assistance. Our motto, "No one is denied the Y" is upheld through the efforts of those who support the "Invest in Youth" campaign.

Thank You!

Ticket availability is limited.
Make all checks payable to:
George Burns Theatre

Ticket prices:
SILVER\$25 each
GOLD\$30 each
PLATINUM\$35 each

Ticket information:
Call Bonnie Jurcisin—261-2161
TICKETS AVAILABLE AT THE 'Y'
14255 STARK ROAD, LIVONIA

BUY YOUR TICKETS
at the
Livonia Family



HURRY!
BEFORE BLACKSTONE
DISAPPEARS



Co-sponsored by The Observer and THE LIVONIA FAMILY



MALLS & MAINSTREETS

MONDAY, NOVEMBER 23, 1992

★ 58

SHOPPING CENTERED



LINDA BACHRACK

Go out on limb when choosing tree toppers

The earliest Christmas ornaments were heavy blown-glass balls, lined in shiny lead and filled with colored wax. Known as kugels, they hung in windows until Queen Victoria and Prince Albert popularized the Christmas tree and the weighty balls were used to separate the branches that held flaming candles.

While the Victorians elevated Christmas to a pageant of tinsel and garland, and wrapped the celebration in heavenly angels and jolly Santas, the holiday grew even more opulent over the years and turned commercial just before World War II. It was then that the first American Christmas ball company, bearing the trademark Shiny Brite, discovered a way to mass produce ornaments.

Each season as you dig through your boxes of tree trimmers, you probably recall a memory associated with every bauble. Whether a mouth-blown antique or a handmade paper cutout from kindergarten days, ornaments not only transform an ordinary tree, but envelop us in warm family tradition.

In searching for fun and imaginative tree toppers, I encountered shoppers with varying tastes and ideas. Each had a personal favorite.



Ruth Seiler of Farmington Hills, for instance, is an Annalee Dolls collector. She always has a red and green tree and tops it with an Annalee snowman. "I've been collecting for years," she said. "I started with mice and added from there."

Annalee Thorndike is a household name to her devoted followers. She designs flexible felt characters like the elf pictured (\$17). The original hand-painted faces are graced with expression. You can see the entire Annalee Dolls collection at **The Village Barn and Christmas Attic** in Franklin.



Seiler also admired this charming muslin-clad angel. Perfect for a homespun, country-look tree, Bethany (\$50) is trimmed in crocheted lace and gracefully spreads her delicate straw wings. I found Bethany in the Christmas store at **Hudson's, Twelve Oaks Mall** in Novi, but she is available at all area Hudson's stores.



Of course, Christmas really celebrates the child in all of us and a child's tree wouldn't be complete without Santa. This whimsical red velvet Santa (\$22) from **The Village Barn and Christmas Attic** is handmade and features a pocket in the back for attaching him to the treetop. Once in place, he can be positioned as you wish.

"For years my children put Santa's cap on top of the tree," reminisced **Bernie Nouhan** of

Dearborn Heights as she contemplated new tree toppers. She chose an old-fashioned St. Nick cloaked in green and red velvet, and holding a lighted wreath.

Not to be missed at **The Christmas Attic** are the Christopher Radko limited edition mouth-blown glass ornaments, crafted by Eastern European glass workers.

In addition to Santas, teddy bears are popular tree ornaments and **Larry and Connie Beaber** of Dearborn create an entire bear tree. I found them in **Jacobson's Birmingham** store carefully choosing among the glass bears. Jacobson's also has an array of stuffed bears and other lovable animals on a toy-themed tree.

Straying a bit from tradition, **Harissa Miller** of Farmington enjoys designing her own contemporary creation for the crown of her tree. Shopping with her son, John, Hiller described her extravagant decoration as a glittering mixture of silver spiky, tulle netting, tiny star garland, and a huge mylar bow with long trailing ribbons.

I found the silver sprays (\$6), gold netting (\$8) and silver and gold star garland (\$4) at **Jacobson's** and Miller suggested **Jo-Ann Fabrics** for the yards of tulle.

And so the tree-trimming party begins. Pop some corn for stringing and be patient with those endless strands of lights. Sing along with your favorite carols, a medieval custom renewed by the Queen of Christmas, Victoria.

Next week, I'll deck your entrance hall with welcoming ideas that cheerfully usher guests into your home.

Linda Bachrack is a Birmingham resident. If you have a subject for her column, she can be reached via touch-tone phone at 953-2047, Ext. 1889.

Hudson's NOSE PINOCCHIO

Northland store's exhibit pulls at holiday heart strings



GUY WARREN/STAFF PHOTOGRAPHER

Pinocchio's promise: "I'll study hard," the puppet tells Gepetto in a scene from Hudson's holiday exhibit at the Northland Mall in Southfield. Watching Pinocchio swing his new schoolbooks are Caitlin and Ian Pasqualone of Redford.



It took seven semi-trucks to move the Pinocchio display to Northland Hudson's. The display is an adaptation of Carlo Collodi's version of the tale about an impoverished, lonely woodcutter who whittles a marionette boy.

BY SUSAN DEMAGGIO
STAFF WRITER

Joey Kieffer, 6, of Mount Clemens, skipped through the Hudson's parking lot at Northland Mall wearing a long, plastic nose secured to his face by an elastic band.

"I loved the Pinocchio show," he said. "It was very good. The best part I liked was when they were inside the whale."

Kieffer said his dad, Thomas, and little sister Veronica, 16 months, also enjoyed the Pinocchio display. After walking through the series of 20 animated vignettes, the children got their picture taken with Santa.

Ed Czarnecki of Huntington Woods, had the same idea as he guided his two toddlers through the Italian village of enchantment last week.

Emma, 5, spoke while her brother Nicholas, 3, shook his head in agreement.

"It's a good, good show," she said. "We have the tape of Pinocchio and we watched it three times. But this is better than the movie."

Not all the visitors to Hudson's third annual holiday fairy tale display were school age.

Emma Paster of Oak Park, and a Hudson's employee, said she came to work early to walk through the exhibit.

"Of course I like it," she laughed. "Why shouldn't I? It's beautiful. We didn't have anything like this when I was a young child."

The display is an adaptation of Carlo Collodi's version of the children's tale about an impoverished, lonely woodcutter who whittles a marionette boy who turns the village upside down with his mischief.

The blue fairy follows the puppet's escapades looking for some good behavior to warrant changing him into a real boy.

Where's Jiminy?

"There's no Jiminy Cricket in our story which confuses some children and adults," said Karen Kleinfeld of Hudson's public relations. "That was Disney's addition to the tale. Theatrical designer Jack Barkla and

a team of talented artisans created the backdrops. Jack Edwards, noted for his work with the Guthrie Theater, designed all the characters' costumes.

"Last year we depicted Peter Pan in our holiday gift to the community," she said. "In 1990 we presented Cinderella. Northland Hudson's was selected for the display because it's our flagship store and the store with an exhibition hall large enough to accommodate the crowds and scenery."

It took seven semi-trucks to move the Pinocchio display from its birthplace in Minneapolis to Michigan last January.

In August a group of artists began painting and rebuilding the little Italian village.

Watch for the magical illusions created to change Pinocchio from a donkey back into a puppet and later from a puppet into a real boy.

Before it comes down on Dec. 31, more than 400,000 visitors are expected to view the exhibit.

The tour through Geppetto's village takes 20-40 minutes. Visitors read storybook passages over each scene as they move through the displays. Background music and theatrical lighting provide an added dimension to the animation.

At the end of the tour a roomful of Pinocchio merchandise awaits

shoppers who want a souvenir of the exhibit.

Group reservations

School and group reservations are available from 9-1:30 p.m. daily through Dec. 18 by calling 443-4138.

Angelo and Ann Pasqualone of Redford brought their grandchildren Ian, 3, and Caitlin, 5, to Northland "to see Pinocchio."

"It's Ian's birthday so we took the children to lunch and to have their pictures taken with Santa," Ann said. "We wanted to spend a special day with them, a day that would bring happy memories to all of us."

The Rivera Family of Redford also toured the exhibit hoping to start a holiday tradition with their daughters, Rebeka, 2, and Rachel, 4.

"This is really nice," said Rachel tugging her little sister onto the next scene. "I think all the kids should come to see Pinocchio and watch the tape at home. We love it."

Separate from the Pinocchio exhibit, but also on the lower level, Santa's Workshop is a second holiday treat.

The 1,300-square-foot shop features 30 elves busily preparing packages for Christmas. Santa moves about the workshop wearing either his traditional suit or suspenders over his work shirt and pants. Photo packages run \$6-\$16.

Yes, Virginia, there are Santa Clauses

BY SUSAN DEMAGGIO
STAFF WRITER

"Every year we try and come up with a new way for Santa to arrive at the mall. This year someone suggested Santa bungee jump down from our new 85-foot-high glass pyramid. We nixed that plan. Too risky. He will arrive at the Southland Mall following a musical performance by Ebony and Ivory."

Charleen Lamphear, marketing Southland Mall, Taylor

The man in the red flannel suit will arrive at shopping centers this week-

end every which way but down the chimney. He'll be introduced by television stars, preceded by marching bands, heralded by knights on horseback and driven to his workshop in a gilded carriage.

At Lakeside Mall in Sterling Heights, Santa will host eight hot breakfasts at six different eateries beginning at 9 a.m. from Dec. 7 through Dec. 20.

"This is very special for the little ones," said Karen McDonald, Lakeside marketing director.

Santa will also speak in American Sign Language from Dec. 11-13 dur-

ing a weekend of special holiday activities for hearing-impaired youngsters at Lakeside.

At Twelve Oaks Mall in Novi, Santa will receive his letters from a magic mailbox that shoots a child's note up a 40-foot tube, chased by lights, accompanied by a little explosion and popping sounds.

"Every child who sends a letter to Santa at the Twelve Oaks North Polestar Service is guaranteed a reply from Santa himself," said Elaine Kah, marketing director.

At the Somerset Collection in Troy, Santa will be the guest of honor at a

week of teas in the Rotunda at 4 p.m. Dec. 10-13. Reservations are a must. Parents are advised to bring their own cameras and video equipment.

Santa will arrive at the Mainstreet shopping districts leading Christmas parades and caroling. He'll be in Plymouth at 12:45 p.m. Dec. 6 at Kellogg Park. In Rochester at Lagniappe, throughout the evening of Nov. 30, and again Dec. 6-24 for pictures at Lindmeyer Photo.

Santa will visit downtown Farmington Dec. 5 after a helicopter landing at 11 a.m.

ADDED ATTRACTIONS

MONDAY, NOV. 23

Carousel rides
Now through Dec. 31. \$1. Full-size 36-foot high, old-fashioned carousel. Located between JC Penney and Kohl's, across from food court. Bring a camera.

NORTHLAND MALL, EIGHT MILE/GREENFIELD. 443-6248.

Santa photos
North Court now through Dec. 24. Special "Carousel Christmas" display features hand-painted Pinocchio dolls, gliding horses and sparkling ice lights.

LAUREL PARK PLACE, W. SIX MILE/NEWSBURGH. 462-1100.

Magic mailbox
Kids send letters off to North Pole via dazzling holiday display. Now through Dec. 24. Display includes four-piece band of giant musical instruments and concert hall complete with marble arches, golden garlands, red drapery and brass instruments. Santa nearby for photos.

TWELVE OAKS MALL, I-96/NOVI ROAD. 348-9438.

Sesame Street Santa
Photos available in hands-on display featuring Big Bird, Hairy Monster, Oscar the Grouch, Cookie Monster, Bert and Ernie. Now through Dec. 24. Christmas trees decorated with ABCs.

OAKLAND MALL, I-75/14 MILE ROAD. 585-6000.

Aisleway Market
Six new vendors move into shopping carts throughout the mall. Gift items include water sport accessories, western wear, candle equipment, video games.

SUMMIT PLACE MALL, TELEGRAPH/ELIZABETH LAKE. 682-0123.

Abercrombie's Opens
Only Abercrombie & Fitch store in Michigan. Men's and

women's leisure wear. Men's fragrance. Division of The Limited Inc.

LAKESIDE MALL, HALL/SCHOENHERR. 586-7816.

FRIDAY, NOV. 27

BLOOD DRIVE

American Red Cross, 9 a.m. to 7 p.m.
Wonderland Mall, Plymouth/Middlebelt. 522-4100.

SANTA ARRIVES

Waterford Kettering High School Band will lead parade through mall. Free balloons and candy. Puppet mobile performs weeknights through Dec. 6. Santa photos 10 a.m. to 9 p.m. Mondays through Saturdays, 11 a.m. to 7 p.m. Sundays Grand Court stage area.
Summit Place Mall, Telegraph/Elizabeth Lake. 682-0123.

LIONEL HOLIDAY TRAIN

Two-tier display on stage in front of JC Penney. Whistles and wheels. Features trestles, mountain ranges, ice skating and hockey rinks, lighted villages and Santa as engineer. Now until Jan. 2.
Summit Place Mall, Telegraph/Elizabeth Lake. 682-0123.

HOSPICE BENEFIT

Light Up A Life With Love. Third annual through Dec. 30. Jacobson's Court. Shoppers can buy memorial ornaments and place on special tree. Proceeds to Angela Hospice of

Livonia. Redford Harmony Quartet performs near tree at noon, Saturday, Nov. 28.
Laurel Park Place, W. Six Mile/Newsburgh. 462-1100.

SANTA VISITS

Saks Fifth Avenue. Third floor. Through Dec. 24. 11 a.m. to 7 p.m.
Somerset Collection, Big Beaver/Coolidge. 643-9000.

Saturday, Nov. 28

BOOK SIGNING

Mitch Albom. 1:30-2:30 p.m. B. Dalton.
Westland Mall, Wayne/Warren. 427-2280.

BLOOD PRESSURE SCREENING

Sponsored by American Heart Association. Free. 11 a.m. to 2 p.m.
Wonderland Mall, Plymouth/Middlebelt. 522-4100.

Monday, Nov. 30

LAGNIAPPE

Downtown Rochester. 6-9 p.m. Shoppers receive "a little something extra" from participating merchants. Tree lighting in front of City Hall, 127 University at Walnut 7 p.m. Santa. Visitors can vote for best holiday window display.
Rochester Road/University. 656-0060.

TOYS FOR TOTS

Now through Dec. 20. Bring new, unwrapped toys for distribution to the needy. Information booth in front of Woolworth's.
Wonderland Mall, Plymouth/Middlebelt. 522-4100.

Clinton's roomie at Yale recalls college days

BY VALERIE OLANDER
STAFF WRITER

At President-elect Bill Clinton's election night victory bash in Little Rock, Ark., he held up a May 4 issue of *The New Republic* magazine in Truman-like-fashion. Large bold letters on the cover blurted out the words, "Why Clinton Can't Win."

The crowd went wild. So did William Coleman III, a Southfield resident, who roomed with the 42nd president-elect at Yale Law School some 20 years ago. Coleman had brought the article with him from Michigan, confident of its irony.

His old college chum dated and signed the magazine for him.

Coleman, a senior partner at the Detroit law firm of Pepper, Hamilton and Scheetz, first recalls meeting Clinton in the Yale Law School cafeteria in 1970.

During the first week of classes Coleman and the handful of other African-Americans attending the Ivy League campus gravitated to each other and by the second week had a designated table inside the cafeteria exclusively for the black students.

It didn't take long before a "tall, robust friendly guy with a thick Southern accent," plopped down at the black table and "violated taboo," Coleman remembers. Clinton's friendly demeanor earned him acceptance in the group quickly.

"He was a lot of fun to be with. He was an inter-

esting, hardworking person," Coleman said of Clinton. "We enjoyed being together."

The two immediately became friends when Clinton approached Coleman shortly thereafter and asked him if he wanted to share a beach house in Milford, Conn., about 20 minutes outside of New Haven, home of Yale University.

The four-bedroom home was also shared with two other students, both from England. Clinton had met the other men while a Rhode Scholar.

Clinton commuted to the university via Volkswagen beetle. Coleman described it as "old, battered and swathedly tied together"

The transportation was needed since Clinton dedicated much of his time and energy to his political interests, Coleman said. During the year at the beach house he remembers the president-elect "spending almost every moment" managing a political campaign for a Democratic candidate running for the U.S. Senate from Connecticut. The senate hopeful captured the districts Clinton was in charge of, but lost the election, Coleman said.

Clinton's political ambitions were apparent then, although Coleman never recalled him saying he wanted to become President of the United States. While most students nearing graduation dreamed of working for large law offices in New York and Washington D.C., Clinton wanted to go back to Arkansas, Coleman said.

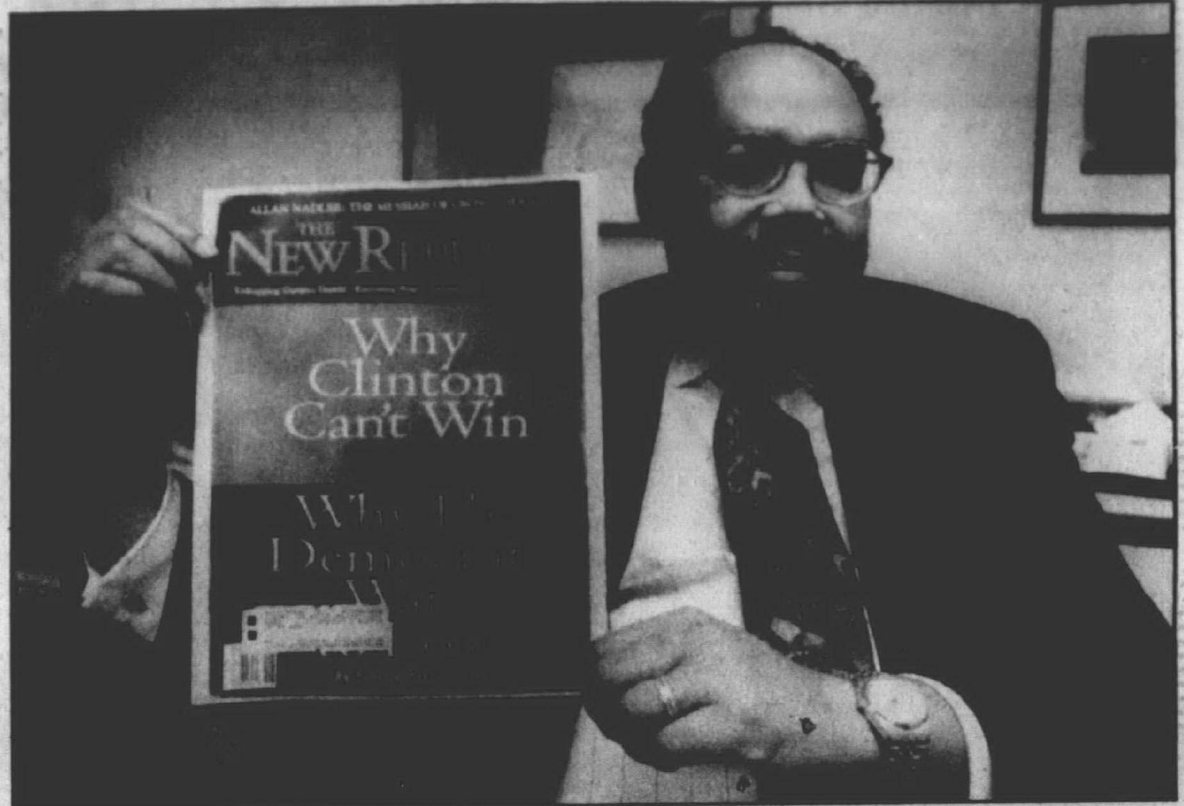

JERRY ZOLYNSKY/STAFF PHOTOGRAPHER

My friend, Bill: Attorney Bill Coleman, a Southfield resident is a friend and former college roommate of another Bill C. — President-elect Bill Clinton. Here he holds aloft a copy of *The New Republic* with an erroneous headline autographed by Clinton.

Group battles 'war toys'

BY VALERIE OLANDER
STAFF WRITER

The end of the cold war and reduction of military arms hasn't chilled one organization's fight to stop the production of war toys.

Women's Action for New Directions will be arming themselves this month with an arsenal of picket signs, leaflets and petitions. They plan to demonstrate at an area toy store Friday when mobs of shoppers are expected to kick off the Christmas shopping season.

Toys the group pinpoints as violent include such popular items such as G.I. Joe, Teenage Mutant Ninja Turtles, Transformers and Nintendo video games.

The Southfield Toys 'R' Us store has been the subject of WAND's Stop War Toys protest over the past two years. About 20 peace groups are sponsoring this year's demonstration led by the national women's organization. Between

50 to 100 protesters are expected.

Toys 'R' Us management was unavailable for comment.

Phyllis Friedman, chair of the Stop War Toys campaign, said the demonstration will be peaceful, seeking to increase awareness from parents and grandparents.

"At three years old these kids are pointing a (Nintendo) gun at a screen, they don't even know it is a gun and that guns can kill," Friedman said.

Another member of the group Laura Perreault, a Southfield resident, said people are unaware of the results when they buy these items for their children. Suggested toys include creative playthings such as art supplies, sports equipment, and musical instruments.

"Who wouldn't agree that if you bombard a kid with violence they're not going to be affected," Friedman added.

The American Psychiatric Association, The American Academy of Pediatrics and the

U.S. Surgeon General, have voiced concerns too. Studies have shown antisocial behavior such as kicking, punching and insults follow the use of violent theme toys.

Friedman claims toy manufacturers and children's television are "sugar-coating" the issue. The Ninja Turtles, for example, "use humor to make it easier for kids to swallow. Here, these turtles are eating pizza and jumping around with swords, beating each other up," she said.

The national group is formerly Women's Action for Nuclear Disarmament, however, the name was changed after the fall of Soviet Union and now focuses on women and children issues as well as political concerns.

WAND's national Stop War Toys campaign has been successful in removing several toys from the shelves including an Arab terrorist doll. Friedman said it not only represented violence but was racist.

Cancer support group meets

Every first Wednesday of the month, "Focus on Living," a support and self-help group for cancer patients and their families, meets at St. Mary Hospital in Livonia.

The group is co-sponsored by the American Cancer Society and enables participants to talk about their feelings and share experiences.

There is no charge, and all in-

terested are welcome. Meetings are 7:30-9 p.m. and are held in the hospital auditorium. For more information, call 464-4800, ext. 2469.

BOARD OF ZONING APPEALS NOTICE
CITY OF PLYMOUTH, MICHIGAN

A regular meeting of the Board of Zoning Appeals will be held on Thursday, December 3, 1992 at 7:30 p.m. in the Commission Chambers of the City Hall to consider:

Z-92-26-105/107/205 Haggerty (Plymouth Towne Apts.)	Nonuse Variance-Ground Sign. Zoned RM-1 Multiple Family. Applicant: John C. Hendry.
Z-92-35-1020 W. Ann Arbor Rd. (Mr. B's Plymouth Grill)	Nonuse Variance-Ground Sign. Zoned B-3 General Business. Applicant: Mr. B's of Plymouth.
Z-92-36-618 S. Main St. (American Auto Repair)	Nonuse Variance-Ground sign. Zoned B-3 General Business. Applicant: Michael Novak.

All interested persons are invited to attend.
Publish: November 23, 1992

DICK'S UPHOLSTERY SHOP
28235 5 Mile Liv. 525-5625

By Popular Demand!
We are now offering Custom Fitted SLIP COVERS
For Your Favorite Sofa or Chair
Extensive Fabric Selection for Slipcovers or Reupholstering

WHAT IS HOSPICE?

HOSPICE IS "A SPECIAL KIND OF CARING" that provides professional, compassionate home health care for anyone with a terminal illness. Hospice care is designed to relieve suffering and pain so that the patient's last days may be spent with quality and dignity at home.

November is ... National Hospice Month

WHAT DOES HOSPICE CARE INCLUDE?

- Professional nursing
- 24-hour on-call emergency care
- Symptom and pain control
- Medical equipment, supplies, medications
- Social Work services
- Spiritual support
- Personal care service
- Nutrition counseling
- Volunteer assistance
- Grief recovery support groups

Hospice a special kind of Caring

For some, Hospice brings HOPE . . .

For others, HELP . . .

For all, LIFE.

Hospice promotes the art of LIVING . . . living while, coincidentally, dying.

Hospice provides nursing management, respite care, spiritual care, bereavement guidance, friendship, and support.

In other words, Hospice makes it the "Best It Can Be."

Hospice believes we can give terminal patients the gift of living while they remain . . .

In touch with themselves, their families, and their God.

Pain-free and in control.

The Women's Committee for Hospice Care salutes and supports the wonderful work of the Tri-County Area Hospice Programs.

Lapeer Area hospice Inc.
544 North Main Street • Lapeer, MI 48666
Phone: (313) 667-0042 • FAX: (313) 677-0060
Contact Persons: Ms. Terry Morgan, Executive Director
Mari Seaman, Patient Care Coord
Areas Served: Northern Oakland, Macomb, Lapeer, and Eastern Genesee Counties

MCF
Hospice of Michigan Cancer Foundation
110 E. Warren Avenue • Detroit, MI 48201
Phone: (313) 833-0710 • FAX: (313) 833-5115
Contact Person: Mary E. Miller, Director
Areas Served: Detroit and surrounding communities, Oakland and Macomb Counties

Hospice Southeastern Michigan
Crossroads Building, #212
16250 Northland Drive
Southfield, MI 48075
Phone: (313) 559-9209 • FAX: (313) 559-6489
Contact Persons: Carolyn Cassin, Administrator
Harnet Pearson, Patient Care Coord
Areas Served: Wayne, Oakland, and Macomb Counties

HOW IS HOSPICE CARE PAID FOR?
HOSPICE care is a covered benefit under Medicare/Medicaid and most private insurance plans. Hospice care is provided to all eligible patients regardless of their ability to pay. All Hospices depend on personal donations and memorials to enable them to provide care for anyone who needs it.

Angela Hospice Home Care
36995 Five Mile Road
Livonia, MI 48154
Phone: (313) 464-7810
FAX: (313) 464-6930
Contact Persons:
Sister Mary Giovanni, Administrator
Lorraine Berlin, Pat. Care Coord
Areas Served:
Livonia and surrounding communities, Western Wayne, South Oakland and Eastern Washtenaw Counties

Hospice SERVICES
OF WESTERN WAYNE COUNTY INC.
6701 Harrison Street • Garden City, MI 48135
Phone: (313) 522-4244 • FAX: (313) 522-2099
127 S. Main Street • Plymouth, MI 48170
Phone: (313) 459-0548
Contact Persons: Maureen Butrico, Director
Cindy Paterson, Patient Care Coord
Areas Served: Western Wayne, South Oakland, Eastern Washtenaw Counties and surrounding communities.

Chc
Cranbrook Hospice Care
281 Enterprise Drive
Bloomfield Hills, MI 48302
Phone: (313) 334-6700
FAX: (313) 334-7064
Contact Persons:
Sister Jane Fox, Director
Lynn Cline, Patient Care Coord
Carole Ford, Intake Facilitator
Areas Served: Oakland, Western Macomb and Northern Wayne Counties

HOW DO YOU REQUEST HOSPICE CARE?
Anyone who is faced with the terminal illness of a loved one may request care by calling Hospice.

cottage hospice
159 Kercheval • Grosse Pointe, MI 48236
Phone: (313) 884-8600 • 2467 • FAX: (313) 885-7023
Contact Persons: Sondra Seely, Director
Patty Foster, Pat. Care Coord
Areas Served: Grosse Pointe and surrounding communities, Wayne and Macomb Counties

hospice Henry Ford
New Center Pavilion - 1116
2921 W. Grand Blvd. • Detroit, MI 48202
Phone: (313) 972-1693 • FAX: (313) 972-1829
Contact Persons: Sondra Seely, Director
Mary vonZitzewitz, Pat. Care Coord
Areas Served: Detroit and surrounding communities, Wayne, Oakland, and Macomb Counties

hospice St. Joseph's of Macomb
215 North Avenue • Mt. Clemens, MI 48044
Phone: (313) 466-9360 • FAX: (313) 466-9970
Contact Persons: Sondra Seely, Director
Patti Cicchanowski, Pat. Care Coord
Areas Served: Mt. Clemens and surrounding communities, Macomb, Southern St. Clair, and Eastern Oakland Counties

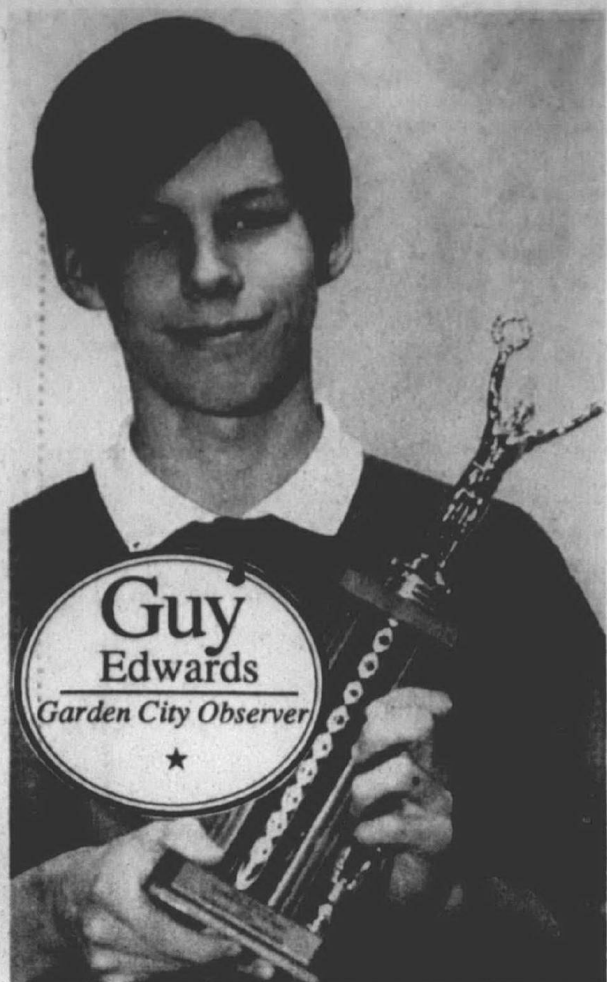

Guy Edwards
Garden City Observer
★



Kevin Haudek
Plymouth Observer
★



Kristin Young
Canton Observer
★



Scott H. Kaplan
Southfield Eccentric
★



Bridjet Nothstine
Westland Observer
★



Dan Schonberg
West Bloomfield Eccentric
★



Jenny Lugar
Birmingham Eccentric
★

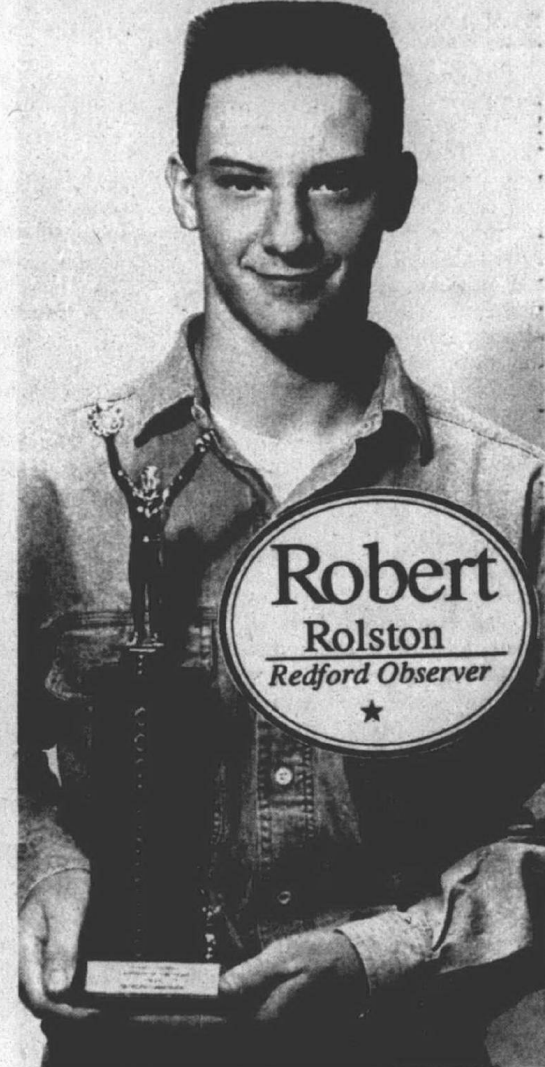

Robert Rolston
Redford Observer
★



Austin Long
Troy Eccentric
★



Matt Michalski
Farmington Observer
★

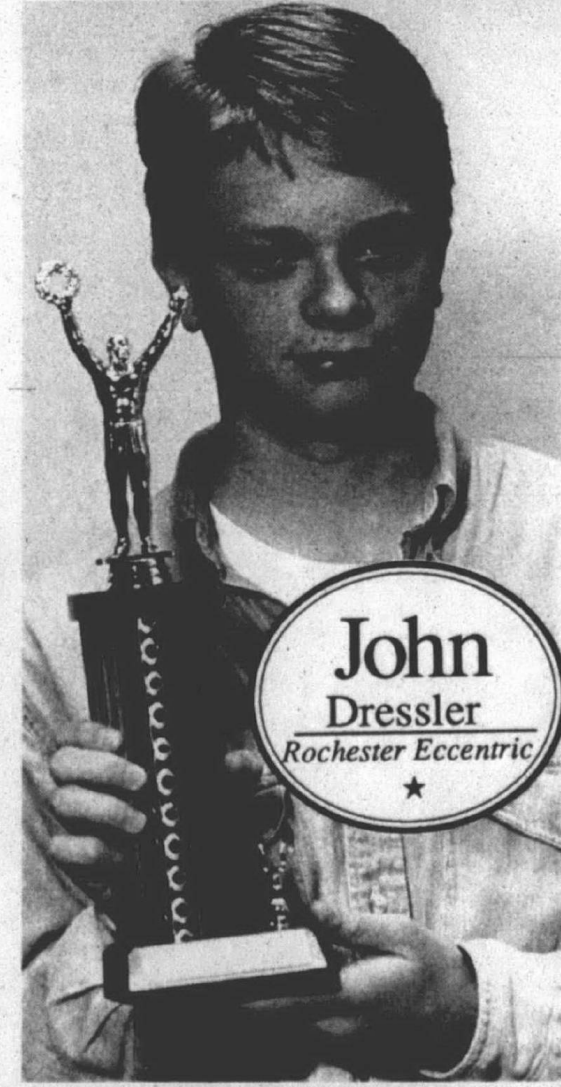

John Dressler
Rochester Eccentric
★



Kathy Resseguie
Livonia Observer
★

12 OF THE BEST

These young people are our 1992 Observer & Eccentric Newspaper Carriers of the Year. This means that they've met all of the requirements of delivering your hometown newspaper, including keeping accurate and up to date records, being courteous to their customers, and turning in their collections on time and in good shape.

They've all been Carriers of the Month, too. They've earned the trophies they're holding with hard work and conscientious behavior. Congratulations, Carriers—you are among the best!

How interested are you in selling your home?

Interested enough to spend a few moments and discover the best place to advertise the fact that your home is for sale?

Good. We knew you were intelligent.

In fact, more than 40% of our readers have college degrees or better.*

And if knowledge is power, let's look at a few powerful facts: this newspaper, the one you're reading right now, reaches some of the most affluent households in Wayne and Oakland counties:

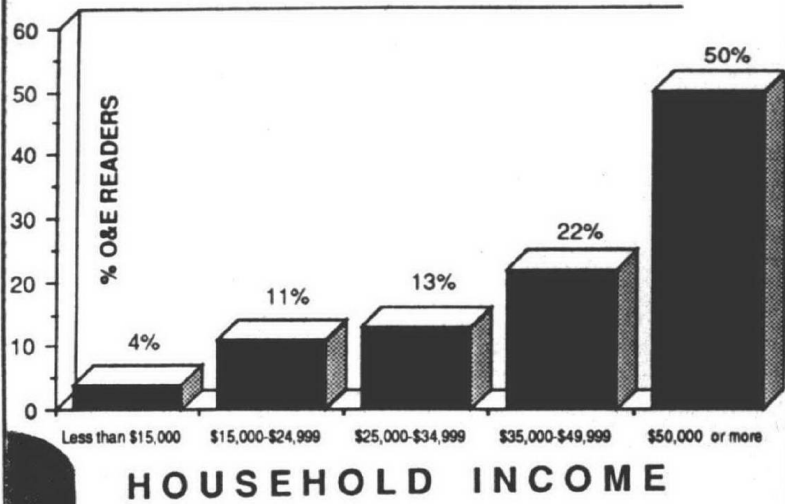

That's a median household income of **more than \$50,000**—\$10,000 more than the income of the people who don't read our newspapers. So when you advertise in your Observer & Eccentric newspapers, you not only reach thousands of smart people, you reach people with substantial incomes.

Now, that's something to smile about.



Our circulation area has **90% home ownership** and look at the value of our reader's homes:

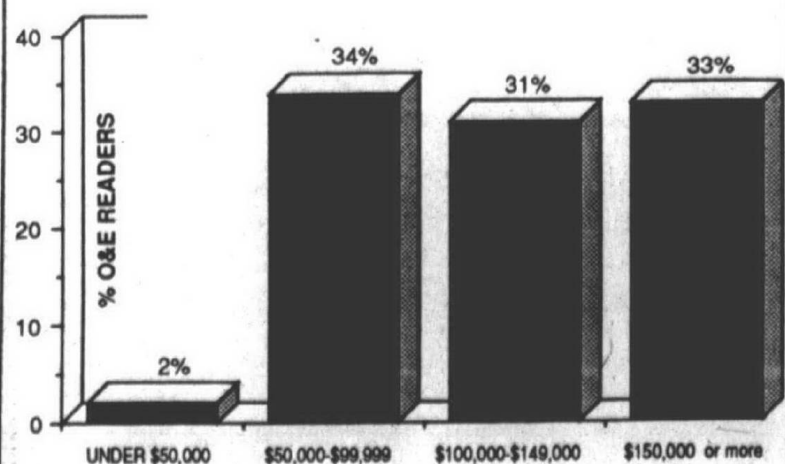

FACT: When you advertise with us you will reach 9 out of 10 adults in the Observer & Eccentric market area who have read weekly classified advertising.*

FACT: 91% of the adults in our market area who had read classified advertising in the past seven days had read it in the Observer & Eccentric*.

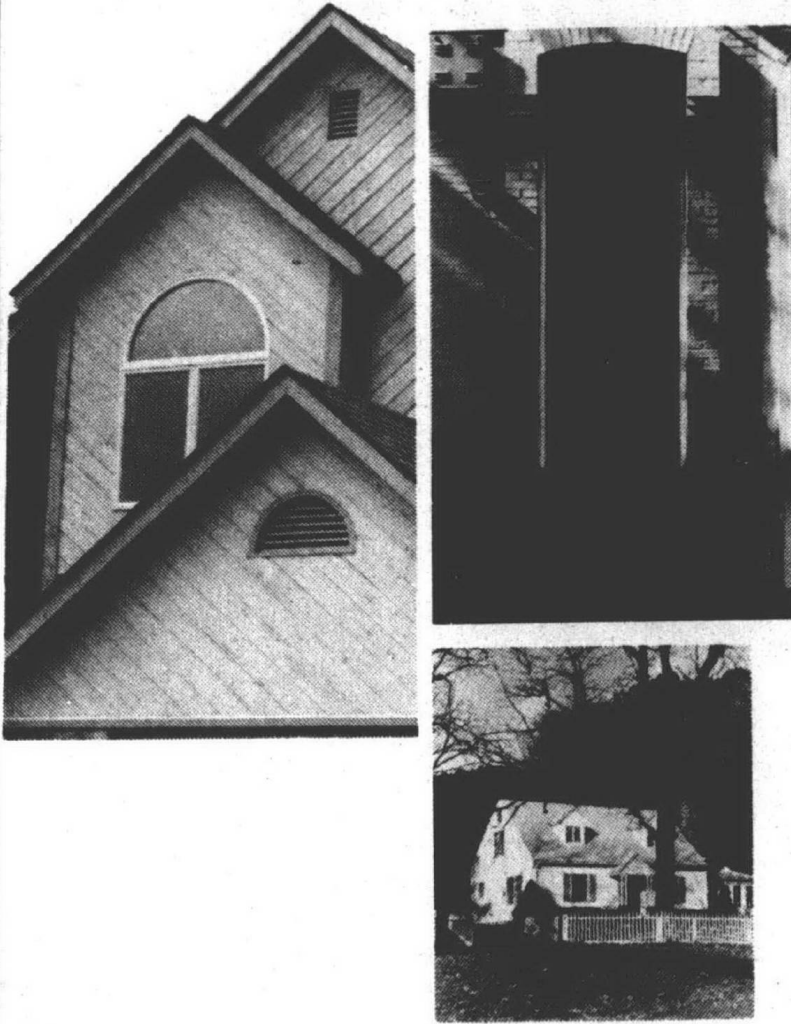

So, we can offer you one quarter of a million adult readers and a very rich market, what else do we have for you? How about an award-winning newspaper— a newspaper that people trust and look forward to reading? One that reaches 25 communities with important local news that's not available anywhere else.

That's us.

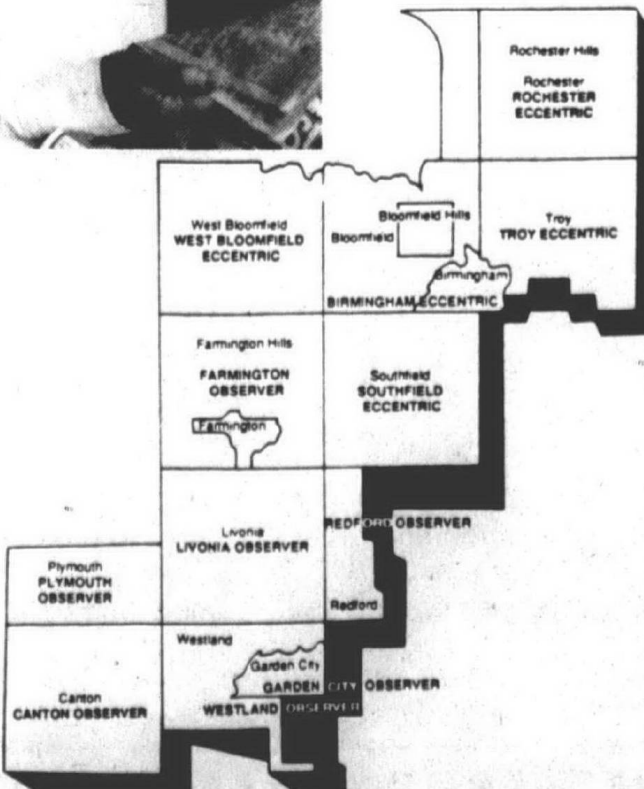

By the way, did you know that all those little ads in the back of this newspaper—the ones placed by people like you—are published in *all 12 newspapers*? Therefore, when you advertise anything from a hom to a home, you will automatically reach this huge, interested reading audience.



What else can we say? We've had years of experience in publishing newspapers and are proud of our record for successfully putting home buyers in touch with home sellers.



In fact, we've just introduced **HOMELINE,**** a great new way to find out about open houses simply by using your touchtone telephone.

Be sure to mention it to your Realtor® so that when it comes time to show your home, it will be described on **HOMELINE.**

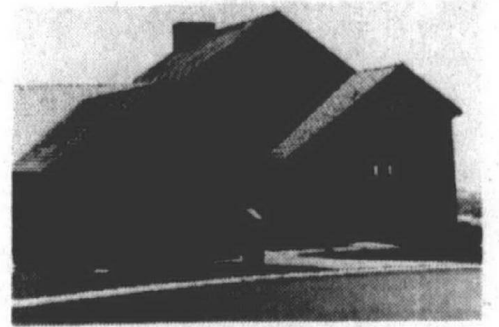

Observer & Eccentric
CLASSIFIED ADVERTISING

644-1070 OAKLAND COUNTY 591-0900 WAYNE COUNTY
852-3222 ROCHESTER ROCHESTER HILLS

Source: 1991 Belden Study, Observer & Eccentric Prime Market Area
**See HOMELINE information in our Classified Real Estate sections

SPORTS

C

MONDAY, NOVEMBER 23, 1992

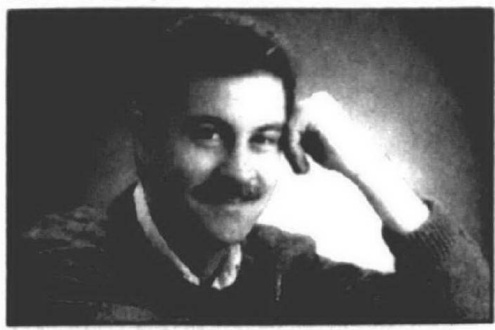

C. J. RISAK

Soccer needs better sports

So. How hot do you like your oil? There are a number of people out there who'd like to dunk my butt — and the remainder of my anatomy — into a cauldron of that very same stuff, while it boils. All because I said soccer players displayed the least amount of sportsmanship.

This viewpoint was determined by my own observations at dozens of high school and college soccer games. During those games, there was an almost complete lack of sportsmanship.

Since that column appeared, I have been deluged by responses. That's great. Really. But first, please understand that, contrary to public perception, I am alone in this endeavor. I have no secretary to answer these calls or help with responses.

Which is why I'm writing this column.

I have not ignored you, but returning every call and still trying to put together a newspaper would not have been possible.

Letters that have been written will be printed. Some of the people who have called and left their opinions on my answering machine will be noted here.

Analyzing the responses

Now. The question is, should I pack my bags and head for the airport, or should I stay and make sure my will's in order?

Based on your responses, neither may be necessary (whew). And, I must admit, that surprised me.

In my business, I had always found people will respond when they strongly disagree. I suppose I'll have to amend that now.

I was surprised to find how many people shared my views. According to my calculations, at least two-thirds of the responses I received agreed at least somewhat with what I said.

OK. Some clarification. Several people thought I generalized. Mrs. A. Ramirez of Farmington Hills called it "a misrepresentation and over-generalization."

Generalization is a label I'm willing to bear. Let me put it like this: No, I have not seen every soccer game played in the metro area, nor do I have plans to. So, by strict definition, I will always be guilty of generalizing.

I will generalize, sort of, in categorizing the responses. Those who favored my views were officials (dozens called, almost all in favor), most coaches (some, like Oakland University's Gary Parsons, took exception to certain parts of the column) and more than a few parents.

Players imitate players

Players almost entirely opposed. Many of their responses were interesting — Lance Pellow, a Plymouth Canton junior varsity player, doubted my definition of "integrity and intensity," then said, "The feeling you get when your team scores a goal or when you stick a player on a breakaway cannot be described by someone watching in the stands."

Depending how it's done, of course, but under most circumstances "sticking a player on a breakaway" is a red-card offense. If that's what you enjoy about the game, something is wrong.

I don't wish to single out a junior varsity player for criticism; it's his attitude that's noteworthy. Players imitate players. They see an older guy toss the ball away to delay a restart and they think that's the thing to do.

I agree there might be some strategic advantage to a stunt like that. But I don't believe that's why players do it. They do it to antagonize their opponents. And that's bad sportsmanship.

I wouldn't feel right if I didn't mention my most interesting response. It comes from Sue Monroe, a school psychologist in West Bloomfield. "It's fairly obvious to me," she said. "They want to roughen up the sport and make it more acceptable to fans and players who watch football and play basketball."

"For a long time, (soccer) was perceived as a sport for sissies. Those kinds of things make it more acceptable."

What to do

Interesting. If it's accurate, and an argument could be made supporting it, then something must be done before the sport becomes an enormous hockey game.

The officials who responded all agreed something must be done, and several had suggestions — including, and this surprised me as well, that they themselves must do a better job.

Officials are often too soft. For example: Delaying the game is a cardable offense, but does that ever happen? I think not.

Talking trash, too (especially to an official), can earn a card. But players test officials, pushing until they are warned. Warn them early and maybe there will be fewer complaints.

See RISAK, 2C

Blazers edge Rocks in hoop final

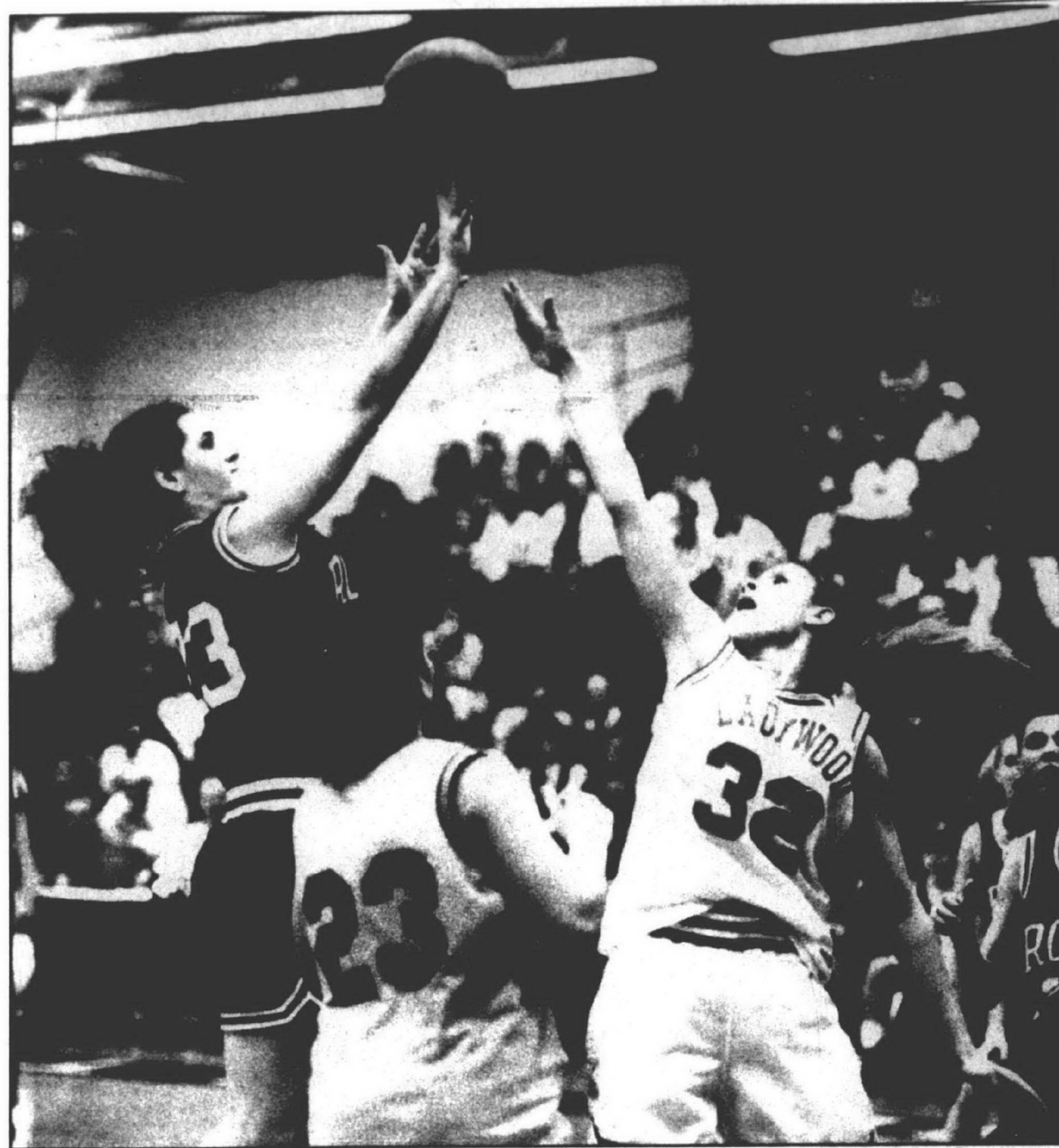

SHERRIE BUZBY/STAFF PHOTOGRAPHER

High scorer: Salem senior Cyndi Platter (left) scored a game-high 26 points, but the Rocks lost to Ladywood in the district final.

■ Plymouth Salem's post-season tournament run in girls basketball ended Friday night with an overtime loss to Livonia Ladywood.

BY STEVE KOWALSKI
STAFF WRITER



Livonia Ladywood senior guard Tracy Prybylski lost her voice but not her shooting touch at the free-throw line.

Prybylski, playing with a cold and laryngitis, made three of five free throws in overtime Friday night to lead Ladywood to a 53-51 victory over Plymouth Salem in a Class A girls basketball district final at Canton.

Prybylski didn't score during regulation but made a pair of free throws with a minute left in OT to give Ladywood a 52-49 lead.

Salem senior center Cyndi Platter, who had a game-high 26 points, scored on a back-door play to make it 52-51, but Prybylski split a pair of free throws with 26 seconds left.

Prybylski said she lost her voice prior to Thursday's practice and was suffering from a cold but neither ailment would keep her from playing.

"It never entered my mind," said Prybylski, who played with four fouls in the fourth quarter and during the OT. "It feels good to finally be on top. I knew a lot of (Salem players), especially (starting guard) Christy Parimucha (who lives across the street)."

Salem enjoyed a 21-9 halftime lead but Ladywood's full-court press caused 18 turnovers in the second half and OT, including 10 in the third quarter.

The Blazers' defense prevailed in the last minute of OT as senior guard Mary Jo Kelly stole a pass with 35 seconds left and the Rocks had a traveling violation with 13 seconds remaining.

"Turnovers were key," said Salem coach Fred Thomann, whose teams have won seven districts in his 10

See DISTRICT, 2C

Ocelots in national volleyball tourney

BY C.J. RISAK
STAFF WRITER

Really, if Schoolcraft College's volleyball team listens to its coach — Tom Teeters — then it won't have many worries heading into the NJCAA Tournament, which starts today in Phoenix.

That's because the Lady Ocelots head into the tournament with that most feared label — at least to its opponents: *unknown quantity*.

That means they aren't really all that good, but they have been known to rise to the occasion. How high? Well, that's the question, isn't it?

Let's define it like this, for now: SC was able to rise enough to get this far (a 38-11 record), and that's really farther than Teeters says he figured they'd go.

And remember: He's been here before. This is SC's fifth-straight trip to the NJCAA Tournament. In Teeters' eight seasons as coach, the Ocelots have made this trip seven times.

So how does this team compare with its predecessors? Is it among the best?

Sorry. "By far, it's not," said Teeters. "This was the weakest team I've had at regionals, going against one of the strongest teams we've faced at regionals (Kellogg CC)."

And yet, Kellogg proved unable to get past SC. The Lady Bruins, 69-1 and ranked fifth in the NJCAA entering the regionals, lost twice to the Ocelots. "There's a certain chemistry that's carried us," explained Teeters. "It's an unknown factor."

"You never know when it's going to take over. It's a factor that's hard to measure."

(Hear that? By that definition, you really can't disappoint; all you can do is excel because no one figures you'll do much, anyway.)

If the Ocelots are going to make a long run in the NJCAAs, that unknown quantity is going to have to reach heretofore unexplored heights. SC has been seeded eighth, something Teeters didn't really want. It puts the Ocelots in the same pool as No. 1-seed Miami-Dade Wolfson.

There are 16 teams in the tournament (four pools of four teams); SC wants to be one of the eight to survive the first cut.

There are certain indicators that

will show if the Ocelots are in the hunt. First and foremost, serving: "Serving well will indicate if we are going to win," said Teeters. "If our serves are not on, we end up losing. We can't afford to miss more than three serves (a game)."

SC lacks a formidable power game, and its blocking isn't great — which makes the need for a tough serve that much more imperative. If an opponent gets a number of easy set opportunities, the Ocelots will be in trouble.

One thing they do well is play defense. "Our serve reception will always be there," said Teeters.

It will have to be. And there will have to be much, much more if SC is going to make a run for the title.

Shamrocks soar past Eagles in grid semi

BY DAN O'MEARA
STAFF WRITER

Redford Catholic Central played power football and Utica Eisenhower a finesse game, but neither was decisive Saturday in a thrilling Class AA semifinal.

Instead, the kicking game had the final say in this classic run-pass confrontation.

Adam Borchert booted his second game-winning field goal in as many weeks to give the Shamrocks a 17-14, overtime victory at Rynearson Stadium in Ypsilanti.

The Shamrocks (12-0) will play defending state champion and top-ranked Saginaw Arthur Hill in a rematch of last year's final at 1 p.m. Saturday in the Silverdome.

After the Eagles (11-1) missed a fourth-down field goal in OT, the Shamrocks didn't bother to run a play. Borchert won it on first down with his 27-yard kick.

"There's no choice in that matter," CC coach Tom Mach said. "With any other decision, you're changing an error."

Borchert booted a 34-yarder on the last play of the game to beat Troy 9-6 the previous week, and CC defeated Detroit King a year ago in the semifinals with an overtime field goal.

"Coach told me 'All you can do is be a hero; don't worry about it,'" Borchert said. "Everything was perfect: the snap, the hold. All I had to do was put it through."

The field goal capped an exciting fourth quarter that saw CC rally to take a 14-7 lead, with two touchdowns coming 1:01 apart, and Eisenhower making a late surge to force OT.

The Shamrocks got all of their 213 yards on the ground. Junior tailback Fred Taylor had 105 on 25 carries, and senior fullback Jason Krueger added 68 on 15 attempts. Each rushed for one TD.

The Eagles countered with the passing of Tim Youngblood, who was 18-of-36 for 247 yards, with one TD and one interception. CC held Ike to a 17 yards net rushing.

CC trailed 7-0 most of the game and struggled early to sustain any offense. Taylor had trouble with his footing in the first half when he had 41 yards on 11 tries, but he changed shoes with assistant coach George Kunec at halftime.

"I was slipping a little too much; I had to do something about it," Taylor said. "(Kunec) asked me if I wanted his shoes. I couldn't do any worse than I already was. Mine were regular grass shoes; these were turf shoes."

Taylor's 15-yard run and Borchert's PAT kick tied the score 7-7 following an eight-play, 51-yard drive at 11:55 in the fourth. CC had 122 yards in the second half.

"In the first half, we'd get a drive going and slip," Mach said, adding the Shamrocks tried to run outside early. "We were third-and-7 a lot and our offense is predicated on being third-and-1 or third-and-2."

"Instead of trying to go around, we just went at them in the second half. That way our footing was better, because when we tried to run sideways we were slipping."

On the ensuing kickoff, CC's Jeff Lachapelle caused a fumble and Jon Wolfe recovered at the Ike 7-yard line. Krueger walked into the end zone on second down from 3 yards. Borchert made it 14-7.

Youngblood threw across his body and over the middle to Jason Paul, who ran to the CC 10 for a 43-yard gain. But Youngblood's pass on the next play was tipped and CC noseguard Paul Nemzek intercepted.

The Shamrocks picked up one first down but had to punt, giving Ike the ball with 4½ minutes left.

On fourth-and-25 at the CC 45, Youngblood threw a Hail Mary pass to 6-foot-3 Scott Hiegel, who leaped from a crowd of players to make the catch at the 7. Ike scored on the next play, Youngblood throwing again to Hiegel with 1:47 left in regulation. Trevor Starnes kicked the tying PAT.

"(Hiegel) was super tall and I tried to jump as high as I could, but he got it down," CC defensive back Brady Pankow said. "In overtime, I had to take it like it was a personal thing."

Youngblood threw three incomplete passes in OT — the CC secondary came up big — before Starnes missed his field-goal attempt. The second pass was caught out of bounds, and Pankow stepped in front of the receiver for a big knockdown on the third try.

The Eagles scored late in the first quarter on Derek Aberlich's 1-yard run after a CC fumble.

CC played the way Ike's defense wanted in the first half but executed to its strength in the second half, according to Ike coach Bob Lantzy.

"We were praying to get them into any kind of perimeter game," he said. "We thought our speed on defense would help us."

"I think they came in with the intention to plug away and work the clock against us. I think they knew they weren't going to option, pitch or sweep on us, so they kept taking those big people inside and wore us down."

Marlins capture 16th district crown

BY DAN O'MEARA
STAFF WRITER

Farmington Hills Mercy, having reached the district final in girls basketball with a second-half comeback, survived one by host Novi to win the championship Friday night, 51-44.

The Marlins, who extended their winning streak to seven games, have won 16 district titles in 18 years under coach Larry Baker.

Mercy (12-11) will play Royal Oak Kimball at 7:30 tonight in the regional tournament at Southfield-Lathrup High School. The championship game is slated for 7 p.m. Tuesday.

"This was a big-time goal for our team this year," Baker said, "and it was a real challenge because all three opponents were highly motivated. They had lost recent district games to us and believed they could get us this year."

The Wildcats (9-13) made their best effort in the second half when they outscored Mercy 32-22 and reduced a 29-12 halftime deficit.

The Marlins, who rallied from

18 points down Wednesday to defeat Walled Lake Central 64-63 in triple overtime, all but decided the game in the first half.

Mercy took advantage of its quickness and used a pressing, trapping defense to force the Wildcats into 20 first-half turnovers.

Consequently, Novi didn't get many shots, and the Marlins were strong on the defensive boards again when they did.

Mercy, which led 16-4 after one quarter, made almost as many shots as the Wildcats attempted in the first half. The Marlins were 13 of 27 from the floor, Novi four of 14.

"We didn't miss a beat from the fourth quarter Wednesday to the first quarter today," Baker said. "I told (the players) that's what I wanted to see. Mercy had to take a cocky attitude, seize the moment and not wait for something to happen."

"We dug a huge hole for them, and they played a terrific third quarter and still had a lot of ground to gain."

The Wildcats, led by Kristin Kenny, who scored 11 of her 19

points in the third quarter, outscored Mercy 11-2 in the last two minutes of the third quarter to get within 37-29.

"Once we got used to what they were doing, the girls started looking at the basket; we pressed them effectively and got back in the game," Novi coach John Hoffman said.

"They could have folded, but they took the bull by the horns and went right after them. We're pleased with the comeback. It's almost as good as a win for me."

Novi made eight of 12 field goals in the third period, while the Marlins (four of 14) had the same kind of shooting touch the Wildcats had earlier.

"They were throwing the ball deep against our trap, and we got more cautious," Baker said. "We're not a cat-and-mouse team. We're more effective in an up-tempo situation where we get to play aggressively. If we slow down and do a lot of thinking we don't seem to play deliberate basketball."

Novi's shooting cooled to five of 17 — the Wildcats missed seven of their first eight — in the

fourth quarter. The Marlins made theirs count (four of seven) and also sank six of nine free throws late in the game.

Valire Jones had seven of her nine points in the second half to help Mercy protect its lead. Dana Wade scored eight of her 12 in the first half. Julie Angell finished with 11 points and Katie Heffernan eight. Christine Edwards added nine for the Wildcats.

"I thought Wednesday and tonight our seniors showed real leadership," Baker said. "I was particularly pleased through this tournament with the court leadership of Katie Heffernan and Dana Wade."

Winning the district was a refreshing event for the Marlins, who were winless in the Central Division of the Catholic League while playing some of the state's best teams.

"We lost 10 of 11 games at one point in the season," Baker said. "All of those opponents save one were ranked. Nonetheless, it took a devastating toll on our confidence."



Sad ending: Andrea Ramsay comforts Salem teammate Cyndi Platter after the Rocks lost in overtime.

District from page 1C

years. "We knew going in we had to pass and catch the ball."

The Blazers advance to tonight's regional game at 6 p.m. against Ann Arbor Huron at Ypsilanti High. Salem finished 13-10.

Ladywood won despite making only 16 of 60 shots (26 percent) and trailing 40-30 with about five minutes left in the fourth quarter.

Tara Overaitis, who had 17 of her team high 20 points after halftime, scored eight straight in the fourth quarter to pull the Blazers within 40-36 with 3:55 left in regulation. A three-point shot by Andrea Putti and Overaitis' three-point play made the score 44-44 with 1:30 remaining.

Platter made two free throws with 23 seconds left to put Salem ahead 46-44, but Anne Poglits forced OT with her only basket of the game and :05 left on the clock.

"I think people got their money's worth tonight," said Ladywood coach Ed Kavanaugh, who won 11 districts and two state championships in his first stint as Blazers' coach. "This is our best district championship we ever got, because we were not supposed to win. We were not supposed to win at the end of the first half."

Kavanaugh doesn't know how the Blazers overcame their shooting woes.

"If I knew that, I'd write a book, be a coaching genius and make a lot of money," Kavanaugh said. "We knew Salem was going to play zone so we mentally said, 'Hey, we've got to make our shots' and panicked a bit."

Ladywood won under similar circumstances Wednesday, recovering from a 13-point deficit to defeat Livonia Stevenson 55-51 in a district semifinal.

"Yeah, it's a carbon copy. They made the plays at the end; we didn't," Thomann said.

Salem got superb play from Platter and senior Shelly Sockow. Platter made eight of 14 shots from the floor and grabbed a game-high 12 rebounds. Sockow finished with 15 points on seven of nine shots and 11 rebounds. Senior guards Leslie Gotts, Cindy McClure and Parimucha also started their final games, although Gotts ended with 2:37 left in regulation after fouling out.

"I feel bad for the whole team," Thomann said. "The seniors worked hard. We didn't win but it doesn't mean we were not successful. We had a lot of peaks and valleys, but it was an awesome ride."

Said Kavanaugh: "Platter is a great player, what I like about her most is the way she catches the ball and faces the basket."

SPORTS SHORTS

Items for the Sports Roundup should be submitted by 5 p.m. Tuesday (for Thursday edition) and 5 p.m. Friday (for the Monday edition).

GIRLS HOOP TRYOUTS

The West Oakland Chargers girls basketball team will have tryouts from 1-3 p.m. Sunday, Dec. 6, at Northville High School for ages 11 through 14.

For information, call Larry Cupp (420-0681) for ages 11 and 13, Bill Kobus (363-0014) for age 12 and Jim Wickett (645-1913) for age 14. The age division is determined by the player's age as of Jan. 1. A tryout fee of \$15 will be assessed.

SWIMMING NEWS

The Livonia-Novi Spartan Aquatic Club will conduct a holiday swim clinic and offer a free week of swimming at its Livonia practice site. For information, call 464-2217 or 591-6818.

YMCA BASKETBALL

The Plymouth YMCA is organizing basketball leagues for children in grades 3 through 9. There will be an open house Friday, Dec. 4, at Pioneer Middle School from 6:30 to 8:30 p.m.

Registration takes place now through Jan. 8. The leagues start Jan. 11 and continue through April. For information, call the YMCA at 453-2904.

WOMEN'S HOOP

The Plymouth Parks and Recreation Department needs one

more team to fill its adult women's basketball league. The entry fee is \$325 plus \$10 per non-resident.

Games will be played Monday nights at Central Middle School. Teams play a 12-game schedule. If interested, call Tom Willette at 455-6620.

SKI CLUB SIGN-UP

Students who missed the club registration night can still sign up for the Plymouth-Canton Ski Club.

The Ski Club is operated as an activity of the Plymouth-Canton Schools' Community Education Department and is open to all students in grades six through 12. Students must be residents of the Plymouth-Canton school district.

The cost to join the club is \$65. Students who want to join the club should contact the Community Education Office at Plymouth Canton High School or call 451-6660 for information.

EQUIPMENT SALE

The Eighth Annual Used Sports Equipment Sale, sponsored by Canton Parks and Recreation Services, will be Saturday, Dec. 5. The sale begins at 10 a.m. in the Coventry Commons Shopping Center, next door to Arbor Drugs, and concludes at 1 p.m.

Sellers can collect their money or pick up unsold items 1-2 p.m. Saturday, Dec. 5. For information, call 397-5110.

Risak from page 1C

In Oakland County, officials experimented with what's called the three-whistle system. The linesmen, as well as the referee, each had whistles and were allowed to call fouls.

I have heard both good and bad regarding this, one side insisting it's necessary, the other saying it creates havoc on the field. I believe it could work, that the proper coordination could be found. Heck, in college basketball they have had three officials for 10 players in a much smaller area; why not in soccer?

Others share blame

But officiating isn't going to rectify all the problems. I mentioned Parsons didn't agree with parts of my original column; the OU coach thinks the problems I mentioned aren't limited to soccer, and singling out soccer is wrong.

I agree that problems exist in almost all sports. But I also stand by my original assertion: I have not witnessed any other sport that is more lacking in sports-

manship than soccer.

Coaches — at all levels — and parents share the blame. When players on Parsons' team explode and a fight breaks out, causing the cancellation of a match, is it Parsons' fault? He's been coaching those players for only a few months.

He should have control over them, but it isn't always easy to tell how much a player will take. Soccer players all seem to have a chip on their shoulder; the question is, how far will they go before they figure that chip's been violated?

And who put it there to begin with? A temperamental age-group coach, perhaps, or an overzealous parent.

Soccer is a fast-growing sport, which means finding competent coaches and officials can be difficult.

But that's not much of an excuse. Because basic sportsmanship and competition should — indeed, must — coexist, whatever the sport.

DCD tops Borgess to win tournament

BY C.J. RISAK
STAFF WRITER

It was a classic court confrontation: Size against speed, pressure against youth.

Detroit Country Day had the size, with 6-foot Shereese Mayo and a pair of 5-9 forwards, Cathy Hayes and Tara Spight. Redford Bishop Borgess had the speed, throughout its lineup, which featured no starter taller than 5-7.

Both had youth, but Country Day's freshmen guards, Pam Bierzynski and Katie Kerr, faced the greater challenge: to handle the Spartans' pressure in a pressure-packed situation — a Class C district final.

Give them both high marks. Instead of folding, or wearing down, or allowing their mistakes to multiply, the Yellowjacket twosome gained poise and confidence as the game progressed. In the pivotal third quarter they spurred their team to a 16-4 advantage, and it ultimately led to a 45-33 Country Day triumph at Detroit Benedictine.

The win gives Country Day, now 19-2, a ticket to the regionals against the Manchester district winner. Borgess bows out at 20-3.

"We were worried about their pressure," said Yellowjacket coach Frank Orlando. "But as the game went on, they got stronger, they believed they could play. I give all the credit to the girls."

Listen to Bierzynski and one would think there was no real turning point, a moment when she and backcourt mate Kerr suddenly believed they could withstand the intense pressure. "You always believe you can handle something," said the 5-5 freshman. "You've just got to feel good in yourself. And we do."

No reason not to now. They did have problems — Country Day committed 22 turnovers — but they executed well enough, using their superior size and going to the basket whenever the opportunity presented itself. Bierzynski

knocked down eight of her 10 points in the second half, most coming on drives.

But Kerr proved to be the heart of this team. She finished with a game-high 16 points, including six in a row in the second quarter that turned a three-point deficit into a 19-18 halftime lead.

Borgess, on the other hand, had its weaknesses laid bare. The Spartans are extremely quick and fast, but, as coach Dave Mann said, "If anything, this showed our lack of a true post game. We haven't had one all year, but we've been able to compensate."

Mann wanted to give credit for his team's abysmal shooting from the floor — 13-of-59 (22 percent) — to Country Day. But that's questionable. The Yellowjackets sat back in a 1-2-2 zone throughout the game, daring Borgess to shoot from the perimeter.

The Spartans did, and missed. In the first 9½ minutes of the second half, they scored just four points. They were 2-of-14 from the field in the third quarter.

They didn't give up. They put together an 11-point run in a four-minute span of the fourth, fueled by six Yellowjacket turnovers. But it was too little, too late. Country Day still led by eight, and only 1:39 remained.

"We played a zone because we felt, as far as matchups are concerned, we couldn't keep up with their speed," said Orlando. "It was just our fortune that they weren't hitting."

"On any given day . . . you never know."

Mann knows. Just a mediocre shooting performance could have saved Borgess (after an 8-for-27 shooting performance in the first half, Country Day was 13-of-27 in the second). Only Maxann Reese reached double figures in scoring, with 12. No other Spartan scored more than six.

And you can't win without putting the ball in the basket.

Isn't It A Shame?

You had no idea, did you, that a seemingly harmless piece of plastic could become an implement of death to an innocent sea creature? Yet it happens, unfortunately, on a grand scale.

Tons of plastic material are lost or dumped into the oceans each year, imperiling the lives of hundreds of thousands of aquatic animals.

Plastic bags, six-pack yokes, fishing nets and other materials can trap fish, mammals, turtles and birds, causing death by drowning or strangulation. Sometimes animals get sick or starve when they eat plastic that they mistake for food.

But plastics pollution is preventable. The National Wildlife Federation is dedicated to protecting America's precious resources — our land, our waters, our people, our wildlife.

You can be a part of the effort. Join the National Wildlife Federation, 1412 16th Street, NW, Washington, DC 20036-2266.

Working for the Nature of Tomorrow
NATIONAL WILDLIFE FEDERATION



Frans Lanning

BERGSTROM'S

plumbing • heating • cooling

30633 Schoolcraft, Livonia
(Between Merriman & Middlebelt)

522-1350

HOURS: MON-FRI 7:30-6; SAT 9-4

NOVEMBER SAVINGS

**Early Bird FURNACE
INSTALLATION SPECIAL**

from **\$1095⁰⁰** **SAVE \$200⁰⁰**

Reg. \$1295.00

INSTALLED & RUNNING

Model GFA050
For Homes Up to 1000 sq. ft.

**SUPER COUPON
INSTALLATION SPECIAL**

**¾ HP GARBAGE
DISPOSAL**

save \$60⁰⁰

INSTALLED FOR
\$239⁹⁵

Regular \$299.95

Coupon cannot be combined with any other offer.
Expires 11-28-92

**SUPER COUPON
INSTALLATION SPECIAL**

**MOEN LAVATORY
FAUCET**

save \$50⁰⁰

\$148⁹⁵

Regular \$198.95

Coupon cannot be combined with any other offer.
Expires 11-28-92

**SUPER COUPON
INSTALLATION SPECIAL**

**40 GALLON
WATER
HEATER**

Save \$30.95

\$319⁰⁰

Regular \$349.95

SAME DAY INSTALLATION
CALL FOR DETAILS
Coupon cannot be combined with any other offer.
Expires 11-28-92

**SUPER COUPON
INSTALLATION SPECIAL**

**American Standard
PLEBE WHITE
TOILET**

save \$75⁰⁰

\$174⁹⁵

Regular \$249.95

Coupon cannot be combined with any other offer.
Expires 11-28-92

Baker's dozen

Salem's Mr. Soccer headlines dream team

For the second year in a row, the All-Observer boys soccer team boasts the No. 1 player in the state.

Plymouth Salem senior Tom Baker was named the 1992 Mr. Soccer by the coaches association. Travis Roy, the former Livonia Stevenson star now playing for the University of Wisconsin, won the award last year.

Baker guided the Rocks to an 18-3-2 season and runner-up finish in the Class A tournament.

Redford Catholic Central, which won the Catholic League title and lost to Salem in the regional final, placed three players on the all-area team.

Western Lakes Activities Association co-champs Livonia Franklin and Farmington are represented by forwards Victor Rodopoulos and Mike Giese.

Livonia Stevenson, Plymouth Canton, Salem and Livonia Churchill put two players each on the honor squad.

Salem's Ken Johnson was selected Coach of the Year.

Despite a lineup riddled by injuries for half the season, he juggled his lineup to keep Salem on a winning roll until the final week of the regular season when Baker went down with an ankle injury.

The Rocks set a school record with a 14-game unbeaten streak until losing consecutive games to Farmington and Churchill.

Salem finished the regular season 12-2-2 and won six straight tournament games before losing 2-1 in overtime to Warren DeLaSalle in the state final.

ALL-AREA TEAM

Anthony Verrino, senior, Redford CC: Verrino led the Shamrocks in scoring with 16 goals and seven assists. The two-time All-Catholic forward and team captain had 35 career goals.

"Anthony is an outstanding high school soccer player," coach Phil LaJoy said. "Opposing coaches would comment on how dangerous a forward Anthony was and how difficult he was to defend."

Mike Giese, senior, Farmington: Giese was a four-year starter for the Falcons and accumulated 54 goals and 37 assists during his career. He scored 27 goals while taking 76 shots and assisted on 10 others this year.

Giese is an Olympic Development Player and the No. 3-rated player in Class A.

"Mike is probably the best forward in the state and, of course, the best player Farmington has had in the last several years," coach Luke Juncaj said. "He has a lot of speed, a lot of skill and is just a great all-round soccer player."

Victor Rodopoulos, junior, Franklin: Rodopoulos helped the Patriots achieve their most successful season in school history with a 12-3-3 finish.

He scored 11 goals and assisted on eight. Rodopoulos, a three-year varsity player, has 38 career goals and 24 assists.

"Victor started for us as a freshman, and the team has become much stronger ever since because of Victor," coach Frantz LaMarre said. "He has been a great asset to the team."

"He's an excellent striker and good distributor. At the start of the year, I told him he was going to draw more defenders and, for the team to be much better, he would have to distribute the ball sooner to other people — and he did that."

Vince Troiani, senior, Churchill: Rich Walos, junior, Redford CC: He

ALL-AREA SOCCER			
ALL-AREA BOYS SOCCER TEAM			
FIRST TEAM			
F — Anthony Verrino	Catholic Central	D — Mike Sneyd	Liv. Stevenson
F — Mike Giese	Farmington	D — Brian Peters	Liv. Churchill
F — Victor Rodopoulos	Liv. Franklin	G — Ryan Henkel	Ply. Canton
F — Vince Troiani	Liv. Churchill	COACH OF THE YEAR	
M — Rich Walos	Catholic Central	Ken Johnson Plymouth Salem	
M — Tom Baker	Ply. Salem	HONORABLE MENTION	
M — Adam Pichler	Liv. Stevenson	Franklin: Dan Kulick, Jason Emero, David Steiner, Patrick Curtis; Salem: Jeff Kley, Paul Dood, Mark MacInnis, Ryan Phipps; Catholic Central: John Andreoli, Tony Lazzeri, Jeff Gardner; Redford Thurston: Jeff Gariepy, Brian Mlynarek; Redford Union: Marcus Braley, John Hunter, Charles Jacobson; Churchill: Goran Rauker, Vincent DeMassa, Justin Monson, Charlie Roberts, Brian O'Beine; Huron Valley Lutheran: Dennis Osiala; Garden City: Steve Griffith, Bill Torn Jr., Matt Griffith, Steve Horvath; Canton: Graham Wilk, Matt Daluisio, Alan Samouelian, Jeff Files; Harrison: Jeremy Teachman; North Farmington: Jared Lawrence; Farmington: John Gomai, Jamie Burton; Kevin Yoder, Sean Noble, Aaron Bommarito; Plymouth Christian: Ryan Thomas; Ryan Bigelow; Stevenson: Andrew Foley, Nick Deren, Steve Willford, Doug Nash, Chris Grodzicki, Scott Sersen.	
M — Jeff Thomas	Liv. Stevenson		
D — Owen Crosby	Ply. Canton		
D — Chris Saline	Ply. Salem		
D — Mike Wdowiak	Ply. Canton		
D — Adam Borchert	Catholic Central		
G — Kal Kaliszewski	Liv. Churchill		
SECOND TEAM			
F — Joe Perron	Ply. Salem		
F — Tom Dempsey	Garden City		
F — Doug Hartley	Valley Lutheran		
F — Richard Burnette	Liv. Franklin		
M — Matt Kopmeyer	Catholic Central		
M — Kris Wiljanen	Farmington		
M — Jason Buelow	Liv. Franklin		
M — Kevin DeHority	Liv. Churchill		
D — Brian Spuck	Ply. Salem		
D — Jason Parent	Catholic Central		



PAUL HURCHMANN/STAFF PHOTOGRAPHER

Mr. Soccer: Salem senior Tom Baker was recognized by the coaches as the top player in the state.

Troiani was Churchill's leading scorer with 12 goals and eight assists but was marked closely by opponents. His career totals were 30 goals and 22 assists.

"We used him as a target, someone to get the ball to quickly," Churchill coach Mark Mason said. "He can get it under control, turn with it and play facing the goal. You can work a give-and-go and be a little more creative when you have a player who can play it close to his feet."

"He got most of the attention from defenders, and he was not able to get as many goals as last year when we had other players to take the pressure off him."

was a steady influence in the middle for the Shamrocks and was an impact player at points up and down the field. He was CC's most valuable player and Player Of The Year in the Catholic League.

Though he was closely marked by opponents, he scored 10 goals and had eight assists this year, bringing his respective career totals to 38 and 32.

"He's a complete ballplayer," LaJoy said. "He has the ability to get the entire team involved in the game. Rich has a work ethic second to none."

Tom Baker, senior, Salem: Baker scored 11 goals and had nine assists this year but was noted more for being an excellent playmaker and his ability to control the game.

He scored 34 goals and had 25 assists during four years as a starter. Baker is a two-time all-state selection and team MVP.

"He's the best player Salem ever had," coach Ken Johnson said. "We were state finalists twice, won a league championship and were 66-12-6 with Tom on the team."

Adam Pichler, senior, Stevenson: Pichler has been a standout midfielder for the Spartans for several years. He scored seven goals and as many assists this year. He had career totals of 16 goals and 15 assists.

"Adam is the most durable defender I have ever coached," Stevenson coach Walt Barrett said. "He constantly wears down his opponents and creates numerous scoring opportunities for himself and his team."

Jeff Thomas, senior, Stevenson: Thomas played in the midfield but also spent time as sweeper. He excelled at disrupting the opposing offense.

Thomas also scored five goals and assisted on eight this year, giving him 13 and 17 for his career, respectively.

"Jeff is an extremely skilled player," Barrett said. "He's the kind of player who can wreck a game in a matter of seconds. I have seen him do this at least a half dozen times in the last two years."

Owen Crosby, senior, Canton: Crosby was a big reason the Chiefs earned a state ranking and had the best overall record in the WLAA.

He used his height (6-foot-5) and basketball ability to his advantage on defense, timing his leaps to head the ball away from the Canton goal. He also scored two goals and had one assist.

"He's probably the most consistent and valuable defender to play soccer at Canton," coach Don Smith said. "He's very coachable and great at performing air-traffic control."

Chris Saline, senior, Salem: Saline played a key role in the Rocks posting nine shutouts and allowing only 21 goals. The Rocks had 19 shutout victories during Saline's two years as a starter.

"He's a strong defender and a great leader," Johnson said.

Mike Wdowiak, senior, Canton: Area coaches thought enough of Canton's defense to put two of its players on the first team.

Wdowiak also contributed two goals and four assists this year. During his career, he scored six goals and was credited with nine assists.

"Mike is a four-year letter winner and is very dedicated to the game," Smith said. "He's one of the reasons for our successful seasons."

Adam Borchert, junior, Redford CC: Borchert has been a starting defender for the Shamrocks since his freshman season. He managed to score two goals and four assists this year.

Borchert is an All-Catholic player and made the all-academic team, too.

"Adam is an extremely intelligent ballplayer," LaJoy said. "He is a strong player who could get the ball out of the defensive zone while under great pressure."

Kal Kaliszewski, senior, Churchill: Kaliszewski, an Olympic Development goalkeeper, recorded 12 shutouts and posted a 0.79 goals-against average. He made 102 saves in 20 games.

Kaliszewski plans to play soccer for a Division I school and pursue a degree in chemical engineering.



Anthony Verrino Catholic Central



Mike Giese Farmington



Victor Rodopoulos Franklin



Vince Troiani Churchill



Rich Walos Catholic Central

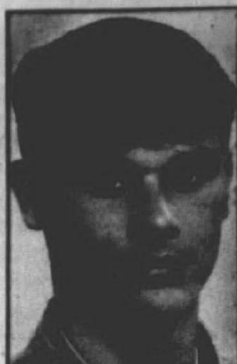

Tom Baker Salem



Adam Pichler Stevenson



Jeff Thomas Stevenson



Owen Crosby Canton



Chris Saline Salem



Mike Wdowiak Canton



Adam Borchert Catholic Central



Kal Kaliszewski Churchill



Ken Johnson Plymouth Salem

WHAT ARE YOU DOING THIS WEEKEND THAT'S SO IMPORTANT YOU CAN'T TEST YOUR HOME FOR RADON?

Radon is a naturally occurring, deadly radioactive gas that finds its way into millions of homes all over the country. It's the second leading cause of lung cancer in America. If you haven't tested for radon yet, pick up a kit this weekend. Testing is quick and easy. Or call for more information today.

CALL 1-800-SOS-RADON.



PRE-SEASON FURNACE SALE

...BONUSES...
Night Set Back Thermostat with all orders

REBATES UP TO \$600

Financing Available

TRU TEMP
Heating & Cooling, Inc.
Commercial & Residential
Canton Twp. 981-5600

Carrier
"We're the Inside Guys" Model 583X

VALUABLE COUPON

LOUIE'S Pizza Express
25750 Joy Rd. (corner of Beech Daley)
Hrs.: M-Th 4-11; Fri. & Sat. 4-12
937-8450

1 LARGE PIZZA
Cheese and Any 5 Items
\$5.99 plus tax

Garlic Stix .99¢ + tax
32 oz. Coke .49¢ + tax
Delivery Extra * NO LIMIT
GOOD ONLY AT LOUIE'S PIZZA

Looking for a new address?

Turn to our Classified Section.

Line up the right tools... in Classified!

Need new tools? Classified's got 'em! It's like a hardware store in print.

Nail down a good deal in Classified!

Observer & Eccentric
CLASSIFIED ADVERTISING

Expert **DEER PROCESSING**

Economy Cut **\$29⁹⁵**

Free! HEAD MOUNT FOR LARGEST DEER!

32 YEARS OF DEER EXPERIENCE

We Make Deer Sausage • Jerky • Slim Jims (available)

DON'S QUALITY MEATS

Taylor Livonia
2801 Van Buren 11501 Plymouth Rd.
(2 blks. E. of Telegraph) (1 blk. West of Meridian)

Hours: Mon. thru Sat. 9 a.m.-7 p.m.
Sunday 10 a.m.-6 p.m.

1-800-932-MEAT
1-800-932-6228

FURNACES

SALES • SERVICE • INSTALLATION • REPAIR

Arcoaire Carrier YORK Comfortmaker Jantrol BARD
HEIL Honeywell

Deal Direct - No Subcontractors
Thousands of Satisfied Customers
- Referrals -

• FULLY LICENSED and INSURED
• ONE DAY INSTALLATION
• ONE DAY SERVICE

Family
As heard on JOE GAGNON'S "Appliance Doctor Program"

Heating, Cooling & Electrical Inc.
Now a Master Electrician Offering Full Electrical Service
Family Owned & Operated for 28 Years

Call For FREE Estimate...
Showroom and Parts
30248 Ford Rd. Garden City **422-8080**

THE Observer & Eccentric NEWSPAPERS CLASSIFIED ADVERTISING

REACH MICHIGAN'S FINEST MARKET



Where You Will Find...

Autos For Sale	SECTIONS	D
Help Wanted	SECTIONS	C,D
Home & Service Guide	SECTIONS	C
Merchandise For Sale	SECTIONS	D
Real Estate	SECTIONS	C
Rentals	SECTIONS	C



DIAL CLASSIFIED DIRECT

Wayne County 591-0900
 Oakland County 644-1070
 Rochester/Rochester Hills 852-3222
 Fax Your Ad 953-2232

Deadlines

For Placing, cancelling or correcting of line ads.
Publication Day Deadline
MONDAY ISSUE: 5 P.M. FRIDAY
THURSDAY ISSUE: 5 P.M. TUESDAY

FOR THE LATEST INFORMATION ON OPEN HOUSES - CALL:

HomeLine
953-2020

OFFICE HOURS:

8:00 A.M.-5:30 P.M.

MONDAY-FRIDAY

AFTER HOURS:

Use Our 24-Hour Voice Mail System

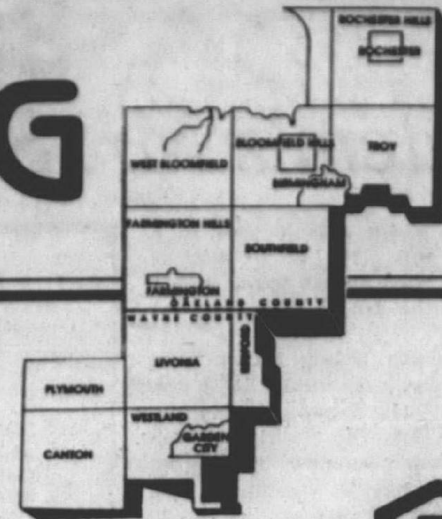

EQUAL HOUSING OPPORTUNITY

Rate
\$3.15 Per Line
 Private party, non-contract and non-commercial only, some classifications excluded, minimum 3 line ad.

All real estate advertising in this newspaper is subject to the Federal Fair Housing Act of 1968 which makes it illegal to advertise "any preference, limitation or discrimination based on race, color, religion, sex, handicap, familial status or national origin or intention to make any such preference, limitation or discrimination." This newspaper will not knowingly accept any advertising for real estate which is in violation of law. Our readers are hereby informed that all dwelling advertised in this newspaper are available on an equal opportunity basis.

INDEX OF CLASSIFICATIONS

HOME & SERVICE GUIDE # 1-899

An alphabetical directory of all your service needs. See Above For Section.

REAL ESTATE FOR SALE # 300-364

- 301 Open Houses
- 302 Birmingham-Bloomfield
- 303 W. Bloomfield-Keego-Orchard Lake
- 304 Farmington-Farmington Hills
- 305 Brighton, Hartland, Howell
- 306 Southfield-Lathrup
- 307 South Lyon, Milford, Highland
- 308 Rochester-Troy
- 309 Royal Oak-Oak Park
- 310 Wixom-Commerce Lakes Area
- 311 Oakland County Homes
- 312 Livonia
- 313 Canton
- 314 Plymouth
- 315 Northville-Nov
- 316 Westland-Garden City
- 317 Redford
- 318 Dearborn-Dearborn Heights
- 319 Grosse Pointe
- 320 Homes - Wayne County
- 321 Homes - Livingston County
- 322 Homes - Macomb County
- 323 Homes - Washtenaw County
- 324 Other Suburban Homes
- 325 Real Estate Services
- 326 Condos
- 327 New Home Builders
- 328 Duplexes & Townhouses
- 329 Apartments for Sale
- 330 Mobile Homes
- 331 Northern Property
- 332 Out Of Town Property

COMMERCIAL/INDUSTRIAL SALE OR LEASE # 365-372

- 365 Business Opportunities
- 366 Office Business Space Sale/Lease
- 367 Business & Professional Buildings Sale/Lease
- 368 Commercial/Retail
- 369 Industrial/Warehouse Sale or Lease
- 370 Income Property
- 371 Industrial Commercial Vacant Property
- 372 Investment Property

REAL ESTATE RENTALS # 400-436

- 400 Apartments
- 401 Furniture Rental
- 402 Furnished Apartments
- 403 Rental Agency
- 404 Houses
- 405 Rent Option to Buy
- 406 Property Mgmt.
- 407 Mobile Homes
- 408 Duplexes
- 410 Flats
- 412 Townhouses/Condominiums
- 413 Time Share
- 414 Southern Rentals
- 415 Vacation Rentals
- 417 Residence to Exchange
- 418 Mobile Home Space
- 420 Rooms
- 421 Living Quarters to Share

- 422 Wanted to Rent
- 423 Wanted to Rent - Resort Property
- 424 House Sitting Service
- 425 Convalescent Nursing Homes
- 426 Home Health Care
- 427 Foster Care
- 428 Homes for the Aged
- 429 Garages/Mini Storage

EMPLOYMENT/INSTRUCTION SERVICES # 500-524

- 500 Help Wanted
- 502 Help Wanted - Dental/Medical
- 504 Help Wanted - Office/Clerical
- 505 Food - Beverages
- 506 Help Wanted Sales
- 507 Help Wanted Part Time
- 508 Help Wanted Domestic
- 509 Help Wanted Couples
- 511 Entertainment
- 512 Situations Wanted, Female
- 513 Situations Wanted, Male
- 514 Situations Wanted, Male/Female
- 515 Child Care
- 516 Elderly Care & Assistance
- 517 Summer Camps
- 518 Education/Instructors
- 519 Nursing Care
- 520 Secretarial Business Services
- 522 Professional Services
- 523 Attorneys/Legal Counseling
- 524 Tax Service

ANNOUNCEMENTS # 600-614

- 600 Personals
- 601 Wedding Chaperons
- 602 Lost & Found (by the word)
- 603 Health, Nutrition, Weight Loss
- 604 Announcements/Meetings/Seminars
- 606 Legal Notices

- 607 Insurance
- 608 Transportation/Travel
- 609 Bingo
- 610 Cards of Thanks
- 612 In Memoriam
- 614 Death Notices
- 620-624 Personal Scene (See Street Scene Mon. Only)

MERCHANDISE # 700-736

- 700 Auction Sales
- 701 Collectibles
- 702 Antiques
- 703 Crafts
- 704 Rummage Sale/Flea Markets
- 705 Wearing Apparel
- 706 Garage Sale - Oakland County
- 707 Garage Sale - Wayne County
- 708 Household Goods - Oakland County
- 709 Household Goods - Wayne County
- 710 Misc. for Sale - Oakland County
- 711 Misc. for Sale - Wayne County
- 712 Appliances
- 713 Bicycles
- 714 Business & Office Equipment
- 715 Computers
- 716 Commercial-Industrial Equipment
- 717 Lawn, Garden, Farm & Snow Equipment
- 718 Building Materials
- 719 Hot Tubs, Spas & Pools
- 720 Farm Produce - Flowers, Plants
- 721 Hospital Equipment
- 722 Hobbies - Coins, Stamps
- 723 Jewelry
- 724 Camera and Supplies
- 726 Musical Instruments
- 727 Video Games, Tapes
- 728 VCR, TV, Stereo, Tape Decks
- 729 CB Radios, Cellular Phones
- 730 Sporting Goods/Exercise Equipment
- 734 Trade or Sell
- 735 Wanted to Buy
- 736 Absolutely Free-Monday only

PETS/LIVESTOCK # 738-749

- 738 Household Pets
- 740 Pet Services
- 744 Horses, Livestock Equipment

WE ACCEPT



PLEASE CHECK YOUR AD

The Observer & Eccentric will issue credit for typographical or other errors only on the first insertion of an advertisement. If an error occurs, the advertiser must notify the Customer Service Department in time to correct the error before the second insertion.

POLICY

All advertising published in The Observer & Eccentric is subject to the conditions stated in the applicable rate card, copies of which are available from the Advertising Department, Observer & Eccentric Newspapers, 36251 Schoolcraft Road, Livonia, MI 48150, (313) 591-2300. The Observer & Eccentric reserves the right not to accept an advertiser's order. Observer & Eccentric Ad-Takers have no authority to bind publication of an advertisement shall constitute final acceptance of the advertiser's order.

CROSSWORD PUZZLER

- ACROSS**
- 1 "Duck ..."
 - 5 Contingent: colloq.
 - 9 Soak up
 - 12 Poker stake
 - 13 Woody plant
 - 14 Type of cross
 - 15 Hinder
 - 17 Toward the Orient
 - 19 Click beetle
 - 21 Remainder
 - 22 Evergreen trees
 - 24 "The Wizard of ..."
 - 25 Spread for drying
 - 26 Dined
 - 27 Asparagus - 29 Concerning
 - 31 "Badge of Courage"
 - 32 Hebrew letter
 - 33 Fulfill
- DOWN**
- 34 Edible seed
 - 35 Meditation chant
 - 36 Elapsed
 - 38 Rodent
 - 39 Vessel
 - 40 Above
 - 41 Openings
 - 42 Tiny particle
 - 44 Blood carrier
 - 46 Make ready
 - 48 Web-footed birds
 - 51 Pose for portrait
 - 52 Danger
 - 54 Region
 - 55 River in Germany
 - 56 Roman statesman
 - 57 Former Russian ruler

Answer to Previous Puzzle



11-23 © 1992 United Feature Syndicate

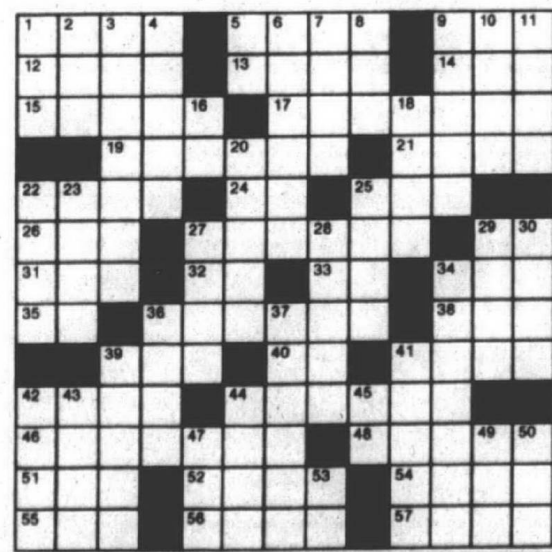

STUMPED? Call For Answers • Touch-tone or Rotary Phones 1-900-454-3535 ext. code 708 • 95¢ per minute

Compliments of The Birmingham-Bloomfield Board of Realtors®

302 Birmingham Bloomfield

CHARMING Salt Box colonial located near Lincoln Hills golf course. Mint condition, 4 bedrooms, 3.5 baths on treed, private setting. Decorator perfect. Asking \$370,000

BLOOMFIELD HILLS SCHOOLS

with 3 bedrooms, 2.5 baths, library plus much more. Gently rolling setting with mature trees. Lots of updating. Priced at \$199,500. Don't miss this one!
 CALL EILEEN YOUNG RALPH MANUEL, 851-6900

FRANKLIN VILLAGE WOODED BEAUTY
 Courses, luxury privacy, and convenience describe this rich, stately colonial on exquisite acreage. Decorator perfect. Great for entertaining. If you don't want horses, use the corral and barn area to create your own private par 3 hole! A resort at home. \$589,900. For your private showing call:
 BEV ONISKO CENTURY 21 NORTHWESTERN 626-9000

303 W. Bimfld. Keego Orchard Lake

BLOOMFIELD TOWNSHIP BEST BUY IN BLOOMFIELD - 3 bedrooms, 2 full baths, dining room, washer and dryer in unit, balcony and updated kitchen and bath! Spacious upper unit. Bloomfield schools, too! (807542) \$179,900 644-4700

REAL ESTATE ONE

BRAND NEW CONSTRUCTION W. Bloomfield, lake access. Compare quality & features to homes 2 times the price. \$149,900. Richard Binder Bldg Co. 681-2228

BRICK RANCH/Walkout with access to prestigious Upper Long Lake. \$180,000 also vacant lot on canal available. 887-2738

CONTEMPORARY-3 bedrooms, cathedral ceilings, central air/vac, in-wall speakers, security system, lake privileges. W. Bloomfield schools. Many extras! \$117,500. 363-1871

WEST BLOOMFIELD MINT 2ND FLOOR RANCH CONDO - Neutral carpeting, freshly painted, new decoration, laundry, 2 bedrooms, 2 full baths, full kitchen, full deck, full garage, full conditioning. \$80,000 CALL 644-4700

REAL ESTATE ONE

WEST BLOOMFIELD PEAK OF PERFECTION. Decorator-perfect, 3 bedroom, 2 1/2 bath townhouse with lovely master suite, in-law suite and privacy from full-size deck! Unbelievable Value! (801220) \$142,900

THE GOOD OLD DAYS - Children running free, neighbors sitting on their front porches. This 3 bedroom Colonial in W. Bloomfield, on Lake and beach privileges on South and Cross Lake. (807099) \$112,800 CALL 644-4700

REAL ESTATE ONE

W. BLOOMFIELD - CUSTOM 2800 sq. ft. walkout ranch, 4 bedrooms, 2 1/2 baths, 2 fireplaces, whirlpool, 2 level deck, 1 acre wooded lot, \$188,000. By owner. 624-8811

304 Farmington Farmington Hills

BRICK Ranch-3 bedroom, attached garage, 2nd living room, dining room, family room, cathedral ceilings, finished basement, large treed lot, fenced yard w/patio. Near downtown Farmington. Warner Sub. \$137,900. 471-9246

FARMINGTON HILLS CUSTOM CONTEMPORARY WOODED LOT
 Beautiful & spacious open floor plan. Great room with soaring ceiling, 30x14 almond kitchen, walls of glass overlook woods. Decking, great master suite, 4 bedrooms. \$249,900.
 CALL BEV ONISKO CENTURY 21 NORTHWESTERN 626-9000

304 Farmington Farmington Hills

A GREAT HOME FOR GROWING FAMILY IN BRIAR HILL 4 bedrooms, family room + heated inground pool. \$129,900.

KENDALLWOOD RANCH Roomy 3 bedrooms, 2 bath, walkout finished basement. Asking price \$125,900. Century 21 MJL Corporate Transferee Service 851-6700

BEAUTIFUL 4500 sq. ft. farmhouse on 1 acre, 4 bedrooms, 2 1/2 baths, paneled library, 9th floor, new kitchen, 3 car garage. Barn/acreage available. \$295,000. 626-2922

FARMINGTON HILLS LOCATION, PRICE, STYLE - Spacious and neutral 3 bedroom, 2 1/2 bath cluster home with great room and library. Move in condition, immediate occupancy. \$158,900 CALL 644-4700 (8M21806773)

REAL ESTATE ONE

FARMINGTON HILLS EXQUISITE, ENCHANTING, ELEGANT! Totally redone 4 bedroom, 3 1/2 bath prairie-style charm-house with 6 car garage, sweeping veranda, 1 acre lot. All amenities! \$349,900 CALL 644-4700

REAL ESTATE ONE

Farmington Hills ABSOLUTELY BREATHTAKING! Open floor plan with a grand traditional floor. Numerous amenities include: 2600 sq. ft., 3 bedrooms, 3 full baths, 2 fireplaces, 3 decks plus courtyard. Den, formal dining room, security system, central air, 2 car garage. Perfect home for entertaining. \$259,900. THE MICHIGAN GROUP REALTORS INC., 591-9200

FARMINGTON SWING SET IN THE YARD - This 4 bedroom, 2 1/2 bath is ready to move your family into. Cracking fireplace, new flooring, space and 37 acre subdivision park, rent option available. \$169,000. (806883) CALL 644-4700

REAL ESTATE ONE

FORECLOSURE 2650 Halsted Rd., Completely redecorated 3 bedroom brick. Full basement. Fantastic lower level. \$119,000 (807438) CALL 644-4700

307 South Lyon Milford-Highland

CONVENIENT - Milford Rd/96. 4 bedrooms, 1 1/2 bath, parlor, office, new designer kitchen, huge garage w/10ft. fruit trees, castie tree house! 1 1/4 acres \$155,000. 486-1978

308 Rochester-Troy

QUAD - loaded with extras, ADT security, central vacuum, attached garage, huge deck, negotiable. \$28-0382 \$149,900-negotiable

ROCHESTER HILLS TRADITIONAL COLONIAL - Elegant Colonial in Rochester Hills. Choice location. Private, beautiful wooded land-locked grounds. Amenities galore. Fantastic lower level. \$319,000 (807438) CALL 644-4700

REAL ESTATE ONE

ROCHESTER HILLS POPULAR BRICK TUDOR brick walkway, in ground pool, central air, full basement, neutral decor, english garden \$174,888 (19668FO)

EXECUTIVE PARADISE custom built home, private lot, inground pool, new kitchen in 1989, 2 new furnaces, 2 air conditioners, elegant lower level with wet bar. Must see. \$319,000 (152NEW) 652-6500

REAL ESTATE ONE

TROY/NEUTRAL AND NICE! Updated, spacious townhome in prime location with 3 bedrooms, 2 1/2 baths, den, fireplace and attached garage. 1 year home warranty and all appliances included! \$113,900. (803063) CALL 644-4700

WASHINGTON

BEST BUY IN THE AREA. Overlooking woods, custom ranch in secluded subdivision. Many amenities, vaulted ceilings, gourmet kitchen with island. \$289,500 (2044DEA) 652-6500

REAL ESTATE ONE

14 & FARMINGTON RDS. 4 bedroom, 2.2 acres, newly decorated, new carpet. Immediate occupancy, L/C available. \$128,000. 478-4673

305 Brighton-Hartland Howell

BRIGHTON AREA- US 23, S. OF 96 4 bedroom brick ranch, finished walk-out. Much more! Not a drive by. \$138,555. 313-231-9748

BRIGHTON CONDO - across from Oak Pointe Golf Course. Beautiful seclusion 1500 sq. ft. plus basement. Just 5 minutes to I-96. \$79,500.

THREE BEDROOM - 2 bath finished walk-out lower level. Gorgeous neutral decor in a great neighborhood. \$115,500. CALL MARCIA GEISE THE MICHIGAN GROUP REALTORS INC., 227-4600 Ext. 246

BRIGHTON - Great family multi-level 4 bedroom, 2 1/2 bath home w/ sunken living room, brick wall fireplace, family room. 2652 sq. ft. Nice area. Brighton schools. \$152,000. 517-546-7658 No Agents Please

306 Southfield-Lathrup

LATHRUP VILLAGE. Immediate occupancy 3 bedroom brick ranch, full basement, dining, fireplace, 2 car attached S. of 12 Mile, W. of Southfield.

SOUTHFIELD, exciting, updated, split floor plan ranch on 150 X 150 acres. Spacious family room, separate master bedroom, 6 car garage \$117,900. EADY, BROKER 538-8043

THIS IS IT! Sharp 4 bedroom colonial Hardwood floors, many extras. Priced at \$119,900.

CONVENIENCE AND LOCATION! Wonderful family home with hardwood floors, full basement, 2 car attached garage. \$104,995. Home Warranty. Century 21 MJL Corporate Transferee Service 851-6700

307 South Lyon Milford-Highland

CONVENIENT - Milford Rd/96. 4 bedrooms, 1 1/2 bath, parlor, office, new designer kitchen, huge garage w/10ft. fruit trees, castie tree house! 1 1/4 acres \$155,000. 486-1978

308 Rochester-Troy

QUAD - loaded with extras, ADT security, central vacuum, attached garage, huge deck, negotiable. \$28-0382 \$149,900-negotiable

ROCHESTER HILLS TRADITIONAL COLONIAL - Elegant Colonial in Rochester Hills. Choice location. Private, beautiful wooded land-locked grounds. Amenities galore. Fantastic lower level. \$319,000 (807438) CALL 644-4700

REAL ESTATE ONE

ROCHESTER HILLS POPULAR BRICK TUDOR brick walkway, in ground pool, central air, full basement, neutral decor, english garden \$174,888 (19668FO)

EXECUTIVE PARADISE custom built home, private lot, inground pool, new kitchen in 1989, 2 new furnaces, 2 air conditioners, elegant lower level with wet bar. Must see. \$319,000 (152NEW) 652-6500

REAL ESTATE ONE

TROY/NEUTRAL AND NICE! Updated, spacious townhome in prime location with 3 bedrooms, 2 1/2 baths, den, fireplace and attached garage. 1 year home warranty and all appliances included! \$113,900. (803063) CALL 644-4700

WASHINGTON

BEST BUY IN THE AREA. Overlooking woods, custom ranch in secluded subdivision. Many amenities, vaulted ceilings, gourmet kitchen with island. \$289,500 (2044DEA) 652-6500

REAL ESTATE ONE

14 & FARMINGTON RDS. 4 bedroom, 2.2 acres, newly decorated, new carpet. Immediate occupancy, L/C available. \$128,000. 478-4673

308 Rochester-Troy

ROCHESTER HILLS CUSTOM QUALITY MASTER piece on approximately 3 1/2 acres, boasts 1st floor master with whirlpool, great room, walkout lower level, 2 fireplaces. Upgraded features! \$475,000 (4544HU)

BEAUTIFUL OAK FLOORING in living room, dining room, study, foyer and powder room. Four bedrooms, central air, and 3000 sq. ft. of luxurious living. (148STO) 652-6500

REAL ESTATE ONE

ROCHESTER INVITING CONTEMPORARY with top-of-the-line amenities. Pella windows with built in slim shades, Jenn-Air, subzero refrigerator. Huge master bedroom, 2 car attached garage in town Rochester. \$139,900 (807FR) 652-8500

REAL ESTATE ONE

ROYAL OAK - 1123 Hickory. 3 bedroom brick ranch, updated kitchen and bath, new furnace and central air, hardwood floors, new paint and carpet, thermal windows, full basement, 2 car garage. \$98,000. Open Sunday, 12-5. 433-3765

309 Royal Oak-Oak Park Huntington Woods

ROYAL OAK - 1123 Hickory. 3 bedroom brick ranch, updated kitchen and bath, new furnace and central air, hardwood floors, new paint and carpet, thermal windows, full basement, 2 car garage. \$98,000. Open Sunday, 12-5. 433-3765

310 Wixom-Commerce Lakes Area

THINK ICE SKATING \$264,900 because soon it will be available right out the door of this custom built, 2600 square foot, lakefront home. With multi-level decking, walk-out finished basement and beautiful views of the lake, you call this paradise. 474-57

310 Wixom-Commerce Lakes Area

Commerce Township NEW CONSTRUCTION MEGANS MEADOW SUB immediate occupancy 1600 sq. ft. ranch, 3 bedroom, 2 bath, 1st floor laundry, many extras. \$152,900. ALSO AVAILABLE. 3 bedroom, 2 1/2 bath colonial. \$157,900. Wixom Rd. N. to Gengary, turn right to Benstein, turn left 1/2 mile. For appointment call: J.T. KELLY CUSTOM HOMES (313) 363-5927

309 Royal Oak-Oak Park Huntington Woods

BERKLEY'S BEST BUY! Charming 2 bedroom aluminum Ranch with over 900 sq. ft. newer energy efficiency furnace & 2-yr. old roof, 1 1/2 car garage, on exceptionally deep lot. Just waiting for your decorating ideas! Mid \$50's. (C167) CHERYL KILINSKI Chamberlain, REALTORS 547-2000

309 Royal Oak-Oak Park Huntington Woods

LOON LAKE PRIVILEGES, Wixom 1,600 sq. ft. Colonial, 3 bedroom, 1 1/2 bath, 1st floor utility, 100 x 125' wooded lot. \$128,000. 624-4989

309 Royal Oak-Oak Park Huntington Woods

CHARMING RANCH Perfect starter or retirement home. Large kitchen with breakfast nook, car garage, finished walkout basement w/ fireplace and lake front porch. \$89,850. C-SOWA-WH. C 360-0450 ERA COUNTRY RIDGE REALTY

309 Royal Oak-Oak Park Huntington Woods

CHARMING RANCH Perfect starter or retirement home. Large kitchen with breakfast nook, car garage, finished walkout basement w/ fireplace and lake front porch. \$89,850. C-SOWA-WH. C 360-0450 ERA COUNTRY RIDGE REAL

312 Livonia

Alluring Homes
WOULD YOU BELIEVE
the price on this outstanding home
filled with charm through Dream
kitchen for the person who loves to
cook. Newer carpet, large deck for
summer entertaining plus garage.
All on a nice corner lot. \$61,500.

LOOK NO MORE
This one's just what you've been
looking for. Spacious bedroom,
2 1/2 bath, full home with charming
walkout family room to patio, newly
remodeled kitchen, 1st floor laundry
and a 2 car garage. Won't last.
\$98,990.

Century 21
Today 462-9800
Award Winning Office
1986, 87, 88, 89, 90 & 91

BEST BUY \$67,900
Beginners best buy North Livonia
brick ranch on a paved street. 3
bedrooms, basement, central air,
and kitchen appliances. 421-5660

PRICED TO SELL \$87,900
This freshly decorated Rosedale
Gardens ranch is priced right and
ready with a large kitchen, finished
basement, plus new living room,
and central air. You'll love it! 462-1660

MORE FEATURES \$89,900
When you would expect for the money
you get, this 3 bedroom, 2 1/2 bath,
basement, 2 car attached garage,
and new windows. This 1977 built
home sits on an extra deep lot and
is ready for you! 462-1660

BIG BRICK RANCH \$97,900
137' built 1,820 square foot, 3 bedrooms,
finished basement, family room,
fireplace, 2 car garage, remodeled
kitchen, central air, and new
windows. 421-5660

SELLER NEEDS A SALE \$117,500
because they have bought another
home. This allows you to get a great
deal on this 3 bedroom brick ranch
with 2 car attached garage in North-
west Livonia. Quick occupancy. 5700

OVER AN ACRE \$129,900
Priced right in North Livonia custom
built brick ranch. 3 bedrooms, 1st
floor laundry, basement, great room
with fireplace, 2 car garage, central
air, and 2 car attached garage. 474-5700

CALL THE MOVER \$156,900
This almost new colonial is located
on a premium cul-de-sac lot and
offers a large kitchen with oak cabinetry,
formal dining room, beautiful
family room and a large master suite
with dressing area. One look and
you'll want to start packing. 462-1660

The Prudential
Wolfe Realty
Independently Owned and Operated

BRAND NEW CONSTRUCTION
Magnificent layout! Great room
with fireplace, large kitchen with
basement, attached garage, brick
ranch, and on a large lot. Come see
for yourself! \$142,000.

ACREAGE
Home sits on a huge acre lot & con-
sists of 2,000 sq. ft. Features oak
fireplace, 2 full baths, new carpet &
completely renovated. Seller will
consider L.O. \$113,900.

EXCEPTIONAL VALUE!!
Prime area custom built ranch has
open floor plan kitchen and dining
area, combined fireplace, formal
dining, 1st floor laundry, ceramic
foyer, "brand new" condition makes
this home a great buy! \$207,000.

REAL ESTATE ONE
261-0700

BRICK RANCH IN LIVONIA, Five
Miles & Levan. A lovely country
kitchen, full basement, large 33 acre lot,
aluminum trim, oversized 2-1/2 car
garage. Priced to please. Low down
payment. Under \$100,000. 261-3579

CELEBRATION will be great in this
new home with w/ep, plaster, large
living room w/fireplace, formal dining
room, kitchen w/unique nook, full
basement, screened porch, 2 car
garage, all in lovely setting. Rosedale
Gardens of Livonia, asking
\$119,000, 7-3/4% interest may be
acceptable. Call:

One Way Realty
473-5500

BY OWNER, brick 1 1/2 level, 1771
sq. ft., 3 bedrooms, family room, 1.5
baths, den, ceiling fan, updated
thru-out, \$110,900 261-3579

CELEBRATION will be great in this
new home with w/ep, plaster, large
living room w/fireplace, formal dining
room, kitchen w/unique nook, full
basement, screened porch, 2 car
garage, all in lovely setting. Rosedale
Gardens of Livonia, asking
\$119,000, 7-3/4% interest may be
acceptable. Call:

One Way Realty
473-5500

JUST LISTED!
Sharply decorated 3 bed-
room ranch with newer carpet
throughout, updated kitchen, fire-
place, and much more. Finished
basement with wet bar and small office
area. 2 car garage. A must see at
only \$89,900.

REALLY PRICED RIGHT
This 3 bedroom ranch in a popular
residential area is nicely decorated
in neutral tones, has a maintenance
free pool, new vinyl windows, 2 car
garage, central air and more.
Another must see at only \$87,000.

MARY MCLEOD
CENTURY 21 ROW 464-7111

LIVONIA
THREE BEDROOM - brick ranch
with nice basement and attached
garage. Home done in neutrals.
Park-like setting yard. Sprinkler sys-
tem. Livonia schools. \$103,900.

THIS BEAUTIFUL - light brick ranch
in N.W. Livonia offers many amenities.
The warm and inviting interior
features a beautiful fully updated
kitchen and baths, brick wall fire-
place in the family room and full
basement for storage. Some of its
features. Prime area offers great
investment potential. Not a drive-by!
\$129,900.

A WOOD DECK - sunning balcony
and enclosed porch overlooks an
acre park-like setting in this 4 bed-
room colonial. Fireplace, basement
garage, family room and formal din-
ing for a lively room. \$159,900.

THE MICHIGAN GROUP
Realtors, Inc.
591-9200

SPARKLER
You will fall in love with this 3 bed-
room ranch, updated kitchen, newer
furnace, nice family room with fire-
room, circular driveway, large
parking lot, attached garage.
Asking \$81,400.

CENTURY 21
ROW
464-7111

WILLOW WOODS
Custom brick ranch with cathedral
ceiling, Sun room with 8 ft. x 6 ft.
doors leading to 700 sq. ft.
fire enclosed cedar deck. \$197,400.
(OE-L-62FA)

EXCEPTIONALLY CLEAN
Maintenance free brick ranch with 3
bedrooms, garage, and home war-
ranty. 2 car garage and home war-
ranty. \$98,500 (OE-L-36D0V)

GARDEN CITY - mint condition 4
year old ranch. House has large
country kitchen, extra such as a
large kitchen with island, great room
with cathedral ceiling, full wall fire-
place, and large master suite. With
professional landscaping, and a
beautiful deck. You'll appreciate this
one inside and out. 462-1660

The Prudential
Wolfe Realty
Independently Owned and Operated

316 Westland
Garden City-Wayne
A BEAUTIFUL \$69,900
cul-de-sac setting isn't the only thing
you'll love about this updated
ranch! There's also a bright,
cheery kitchen, finished basement
with 4th bedroom, and a 2 car gar-
age. 462-1660

ANN HONEYCUTT
Century 21 Elite
525-1797 522-7626

ROOBY COMFORT
Great home for an active family. Has
3 bedrooms, 2 1/2 baths, great room
with fireplace, 2 car attached gar-
age, totally equipped. \$179,999.
F38B-L. Call 474-3303
ERA COUNTRY RIDGE REALTY

The Charm of
Rosedale Gardens
is found in our just under 2,000
sq. ft. 4 bedroom Colonial on a dou-
ble lot. 3 1/2 baths, finished basement
improvements including family room
with cathedral ceiling and central
air. \$149,900.

Remerica
HOMETOWN REALTORS
453-0012
REMEMBER REMERICA

313 Canton
A SPARKLING
2 BEDROOM CONDO GEM!
Brand new quality stain-master cap-
ing, neutral colors, new vinyl win-
dows, air & furnace. All appliances.
Great investment. \$64,900.
N-99A-C. Call 348-6767
ERA COUNTRY RIDGE REALTY

BRAND NEW COLONIALS
3 & 4 bedrooms to choose from.
Starting at \$122,500. 397-3479

CANTON - affordable 3 or 4 bed-
room, 2 1/2 bath colonial with in-
ground pool, 5 houses from school.
\$129,900.

CANTON - Open Sun, 1-5
42025 N. Umbertland, E of Sheldon
between Ford & Warren. 4 bedroom
colonial, 2 car attached garage,
family room w/fireplace, finished
basement, in-ground heated granite
pool. Immediate occupancy.
\$127,500. No Agents. 455-4423

312 Livonia

LIVONIA - DEERCREEK SUB
4 bedroom, 3200 sq. ft., over size
corner lot, master suite, upgrades
gators. By Owner. 478-4927

NORTHERN LIVONIA
Just listed, a beautiful 2500 sq. ft.
colonial with full basement, library,
2 1/2 baths, formal dining room,
central air, hardwood floors, remod-
eled kitchen. \$164,899. F-15LE-L.
Call 474-3303.
ERA COUNTRY RIDGE REALTY

PRICE REDUCED
Immediate occupancy, Brick 3 plus
bedrooms, finished basement, pool.
Asking \$93,000. Ask for...

Ann Honeycutt
Century 21 Elite
525-1797 522-7626

ROOBY COMFORT
Great home for an active family. Has
3 bedrooms, 2 1/2 baths, great room
with fireplace, 2 car attached gar-
age, totally equipped. \$179,999.
F38B-L. Call 474-3303
ERA COUNTRY RIDGE REALTY

The Charm of
Rosedale Gardens
is found in our just under 2,000
sq. ft. 4 bedroom Colonial on a dou-
ble lot. 3 1/2 baths, finished basement
improvements including family room
with cathedral ceiling and central
air. \$149,900.

Remerica
HOMETOWN REALTORS
453-0012
REMEMBER REMERICA

313 Canton
A SPARKLING
2 BEDROOM CONDO GEM!
Brand new quality stain-master cap-
ing, neutral colors, new vinyl win-
dows, air & furnace. All appliances.
Great investment. \$64,900.
N-99A-C. Call 348-6767
ERA COUNTRY RIDGE REALTY

BRAND NEW COLONIALS
3 & 4 bedrooms to choose from.
Starting at \$122,500. 397-3479

CANTON - affordable 3 or 4 bed-
room, 2 1/2 bath colonial with in-
ground pool, 5 houses from school.
\$129,900.

CANTON - Open Sun, 1-5
42025 N. Umbertland, E of Sheldon
between Ford & Warren. 4 bedroom
colonial, 2 car attached garage,
family room w/fireplace, finished
basement, in-ground heated granite
pool. Immediate occupancy.
\$127,500. No Agents. 455-4423

DESPERATE
Sellers need to sell right away. Bring
an offer. 4 bedroom, 2 1/2 bath, all
the amenities. Mint condition. Reduced
\$8,000 to \$146,900. Some flexibility
on price. Immediate occupancy.
Call right away.

RICHARD B. HANES II
RE/MAX CROSSROADS
453-8700 OR 981-7727

EVERYTHING DONE - updates in-
clude new 22x18 fanless room w/cath-
edral ceiling and fireplace, fur-
nace and central air, all new win-
dows, completely updated kitchen
and bath, newer deck, newer carpet
and a full basement. Asking,
\$109,900. (C9948). For details,
call: JOHN CURRY, 453-8700

THE MICHIGAN GROUP
REALTORS, INC. 459-3600

NORTH CANTON
Lovely 3 bedroom, 2 bath ranch.
New kitchen/baths & updates gal-
erie. \$124,500. 455-5527

N. Canton Colonial
Large 4 bedroom Colonial featuring
2 1/2 baths, family room with fire-
place, master bedroom with fire-
place and master bath. Central air,
full basement, extra large garage
with lots of extra storage. Located
close to shopping. Home warranted,
\$129,900.

Remerica
HOMETOWN REALTORS
420-3400
REMEMBER REMERICA

LIVONIA SCHOOLS - 4 bedroom
ranch with 2 full baths, large country
kitchen with island sink, picture win-
dow in kitchen overlooking park.
Full basement, 2 1/2 car garage. New-
er roof, furnace & central air. By
Owner. (empty nest syndrome).
\$110,000. S of Ann Arbor, W of
Middlebelt, 29651 Shackett.
Shown by appt. only. 525-6919

WESTLAND - 2305 SECOND ST.
\$3,300 DOWN
\$468.00 Per Mo.

Brand new 3 bedroom colonial. Car-
peted throughout. Includes refrig-
erator, stove, washer & dryer, full
basement. Paint & tile part of clos-
ing costs. 7.0% FHA-ARM. 30 year
mortgage.
ROSS REALTY 326-8300

Simple Assumption
Possible on this maintenance free
brick & aluminum ranch. Spacious
floor plan with over 1,000 sq. ft. fea-
tures include 3 bedrooms, large
country kitchen & finished basem-
ent. Priced to sell at \$59,900. Ask
for...

PATTY STROPS or
GARY JONES

Remerica
HOMETOWN REALTORS
459-6222
REMEMBER REMERICA

THE PERFECT HOME
Gorgeous, softplush, low taxes & ex-
tra! 3 bedrooms, 2 1/2 baths, 3 bedroom
ranch, enormous family room &
master bedroom, 2 baths, updates
down in garage, & beautiful park-
more - won't last at \$85,000.

Wayne - 3 bedroom, new furnace,
new 3 car garage, new driveway &
sidewalks, built-in appliances.
\$57,900. Leave message. 595-7648

WESTLAND - A NEW COMMUNITY
SINGLE FAMILY HOMES
\$79,990
\$4800
MOVES YOU IN
Preview 5 new exciting models, full
basement, 2 car attached garage,
large master bedroom suite and
much more. Get on the ground
floor.

MILLPOINTE
595-1010

WESTLAND LIVONIA
"O" DOWN
For qualified Veteran, Brick 3 bed-
room ranch, large country kitchen,
cozy fireplace, immediate occupan-
cy. Asking \$62,500. Call...

Ann Honeycutt
Century 21 Elite
525-1797 522-7626

WESTLAND RANCH - This is it. 3
bedroom ranch w/full basement and
a two car garage. Some updates in-
clude: carpets, windows, doors, paint
and solar heat collector offering VA or
FHA terms. Asking \$81,900.
(CD955). CALL CURT
THE MICHIGAN GROUP
REALTORS INC. 459-3600

WESTLAND - 4 bedroom brick &
aluminum siding. Sharp remod-
eled thru-out plus new windows.
\$54,900.

315 Northville-Nov
NORTHVILLE - Colony III 4 bed-
room Colonial, 2 1/2 baths, library/5th
bedroom, family room, computer
room, circular drive, sprinklers,
many extras. \$196,000. 420-3326

NORTHVILLE TWP.
NEW CONSTRUCTION
IMMEDIATE OCCUPANCY
Approximately 3,000 sq. ft., 3 bed-
rooms, 2 1/2 baths, woodpeckling in-
cluded. Walk-out patio on large fully
landscaped golf course. 1 1/2 miles
W. of Haggerty, just off 6 Mile Rd.
Open Sun, 1-5, 737-0692.
WINDHAM REALTY GROUP, Inc.

QUALITY BUILT - Northville \$244,500
Tudor with the extra such as a
large kitchen with island, great room
with cathedral ceiling, full wall fire-
place, and large master suite. With
professional landscaping, and a
beautiful deck. You'll appreciate this
one inside and out. 462-1660

316 Westland
Garden City-Wayne
BY OWNER, WESTLAND - Clean,
maintenance free, 4 bedrooms,
\$157,900. Leave message. 595-7648

WESTLAND - A NEW COMMUNITY
SINGLE FAMILY HOMES
\$79,990
\$4800
MOVES YOU IN
Preview 5 new exciting models, full
basement, 2 car attached garage,
large master bedroom suite and
much more. Get on the ground
floor.

MILLPOINTE
595-1010

WESTLAND LIVONIA
"O" DOWN
For qualified Veteran, Brick 3 bed-
room ranch, large country kitchen,
cozy fireplace, immediate occupan-
cy. Asking \$62,500. Call...

Ann Honeycutt
Century 21 Elite
525-1797 522-7626

WESTLAND RANCH - This is it. 3
bedroom ranch w/full basement and
a two car garage. Some updates in-
clude: carpets, windows, doors, paint
and solar heat collector offering VA or
FHA terms. Asking \$81,900.
(CD955). CALL CURT
THE MICHIGAN GROUP
REALTORS INC. 459-3600

WESTLAND - 4 bedroom brick &
aluminum siding. Sharp remod-
eled thru-out plus new windows.
\$54,900.

316 Westland
Garden City-Wayne
A BEAUTIFUL \$69,900
cul-de-sac setting isn't the only thing
you'll love about this updated
ranch! There's also a bright,
cheery kitchen, finished basement
with 4th bedroom, and a 2 car gar-
age. 462-1660

ANN HONEYCUTT
Century 21 Elite
525-1797 522-7626

316 Westland

A BEAUTIFUL \$69,900
cul-de-sac setting isn't the only thing
you'll love about this updated
ranch! There's also a bright,
cheery kitchen, finished basement
with 4th bedroom, and a 2 car gar-
age. 462-1660

The Prudential
Wolfe Realty
Independently Owned and Operated

SHARP 3 BEDROOM BRICK RANCH, SUPER
KITCHEN, dishwasher, finished basem-
ent, screen enclosures on custom
deck, updates. \$64,900

Wayne - starter home, spacious
bedrooms, formal dining room,
basement, mechanic's dream 2 1/2
car garage with lift, private, dead-
end street, low down - low pay-
ments. \$52,900

Century 21
One Way Realty
473-5500

CASTELLI 525-7900
1990-91 CENTURION
AWARD WINNING OFFICE

BUILT IN 1991
This newer construction home has
1300 sq. ft., 3 bedroom brick ranch
with master bath, cathedral
ceiling, open floor plan, 1st floor
laundry & 9 year home warranty.
\$79,900

DELIGHTFULLY
PLEASANT!
Live better in your own home! Newly
decorated, 3 bedroom brick ranch,
2 1/2 baths, formal kitchen & 2 1/2 car
garage with opener. Only \$61,900!

Century 21
J. Scott, Inc.
522-3200
453-4300

COUNTRY LIVING
on half acre 2 bedrooms, low taxes,
newer furnace, roof, vinyl siding &
carpet. Immediate occupancy.
\$63,000.

WOLVERINE
PROPERTIES INC.
532-0600

HANDYMAN'S DREAM!!!
4 bedrooms, large lot, garage,
needs some TLC. \$58,000. Call...

JOHN TOYE
Remerica Pickering & Assoc. 458-4900

HOT! HOT!
3 bedroom ranch, basement, 2 car
garage, newer roof and windows,
updated kitchen. This home is a doll
house! FHA-VA-TERMS. Immediate.
Asking \$69,900.

Century 21
ROW
464-7111

LARGE PRICE
REDUCTION
Owners moving out of state. Must
sell low! Low price, low taxes and
low interest rates. 3 bedrooms plus
a study. Large kitchen, finished
basement with bar-and-1/2 bath. Flor-
ida room & garage and more. Beauti-
ful Garden City neighborhood. Hur-
ry! It won't last! \$69,900. Call...

DAVE THOMSON

Remerica
HOMETOWN REALTORS
420-3400
REMEMBER REMERICA

LIVONIA SCHOOLS - 4 bedroom
ranch with 2 full baths, large country
kitchen with island sink, picture win-
dow in kitchen overlooking park.
Full basement, 2 1/2 car garage. New-
er roof, furnace & central air. By
Owner. (empty nest syndrome).
\$110,000. S of Ann Arbor, W of
Middlebelt, 29651 Shackett.
Shown by appt. only. 525-6919

WESTLAND - 2305 SECOND ST.
\$3,300 DOWN
\$468.00 Per Mo.

Brand new 3 bedroom colonial. Car-
peted throughout. Includes refrig-
erator, stove, washer & dryer, full
basement. Paint & tile part of clos-
ing costs. 7.0% FHA-ARM. 30 year
mortgage.
ROSS REALTY 326-8300

Simple Assumption
Possible on this maintenance free
brick & aluminum ranch. Spacious
floor plan with over 1,000 sq. ft. fea-
tures include 3 bedrooms, large
country kitchen & finished basem-
ent. Priced to sell at \$59,900. Ask
for...

PATTY STROPS or
GARY JONES

Remerica
HOMETOWN REALTORS
459-6222
REMEMBER REMERICA

THE PERFECT HOME
Gorgeous, softplush, low taxes & ex-
tra! 3 bedrooms, 2 1/2 baths, 3 bedroom
ranch, enormous family room &
master bedroom, 2 baths, updates
down in garage, & beautiful park-
more - won't last at \$85,000.

Wayne - 3 bedroom, new furnace,
new 3 car garage, new driveway &
sidewalks, built-in appliances.
\$57,900. Leave message. 595-7648

WESTLAND - A NEW COMMUNITY
SINGLE FAMILY HOMES
\$79,990
\$4800
MOVES YOU IN
Preview 5 new exciting models, full
basement, 2 car attached garage,
large master bedroom suite and
much more. Get on the ground
floor.

MILLPOINTE
595-1010

WESTLAND LIVONIA
"O" DOWN
For qualified Veteran, Brick 3 bed-
room ranch, large country kitchen,
cozy fireplace, immediate occupan-
cy. Asking \$62,500. Call...

Ann Honeycutt
Century 21 Elite
525-1797 522-7626

WESTLAND RANCH - This is it. 3
bedroom ranch w/full basement and
a two car garage. Some updates in-
clude: carpets, windows, doors, paint
and solar heat collector offering VA or
FHA terms. Asking \$81,900.
(CD955). CALL CURT
THE MICHIGAN GROUP
REALTORS INC. 459-3600

WESTLAND - 4 bedroom brick &
aluminum siding. Sharp remod-
eled thru-out plus new windows.
\$54,900.

316 Westland
Garden City-Wayne
A BEAUTIFUL \$69,900
cul-de-sac setting isn't the only thing
you'll love about this updated
ranch! There's also a bright,
cheery kitchen, finished basement
with 4th bedroom, and a 2 car gar-
age. 462-1660

ANN HONEYCUTT
Century 21 Elite
525-1797 522-7626

WESTLAND RANCH - This is it. 3
bedroom ranch w/full basement and
a two car garage. Some updates in-
clude: carpets, windows, doors, paint
and solar heat collector offering VA or
FHA terms. Asking \$81,900.
(CD955). CALL CURT
THE MICHIGAN GROUP
REALTORS INC. 459-3600

WESTLAND - 4 bedroom brick &
aluminum siding. Sharp remod-
eled thru-out plus new windows.
\$54,900.

316 Westland
Garden City-Wayne
A BEAUTIFUL \$69,900
cul-de-sac setting isn't the only thing
you'll love about this updated
ranch! There's also a bright,
cheery kitchen, finished basement
with 4th bedroom, and a 2 car gar-
age. 462-1660

ANN HONEYCUTT
Century 21 Elite
525-1797 522-7626

WESTLAND RANCH - This is it. 3
bedroom ranch w/full basement and
a two car garage. Some updates in-
clude: carpets, windows, doors, paint
and solar heat collector offering VA or
FHA terms. Asking \$81,900.
(CD955). CALL CURT
THE MICHIGAN GROUP
REALTORS INC. 459-3600

WESTLAND - 4 bedroom brick &
aluminum siding. Sharp remod-
eled thru-out plus new windows.
\$54,900.

316 Westland
Garden City-Wayne
A BEAUTIFUL \$69,900
cul-de-sac setting isn't the only thing
you'll love about this updated
ranch! There's also a bright,
cheery kitchen, finished basement
with 4th bedroom, and a 2 car gar-
age. 462-1660

ANN HONEYCUTT
Century 21 Elite
525-1797 522-7626

WESTLAND RANCH - This is it. 3
bedroom ranch w/full basement and
a two car garage. Some updates in-
clude: carpets, windows, doors, paint
and solar heat collector offering VA or
FHA terms. Asking \$81,900.
(CD955). CALL CURT
THE MICHIGAN GROUP
REALTORS INC. 459-3600

WESTLAND - 4 bedroom brick &
aluminum siding. Sharp remod-
eled thru-out plus new windows.
\$54,900.

317 Redford

BEGINNERS LUCK \$56,900
Great looking brick bungalow in an
attractive neighborhood. This 3 bed-
room 1 1/2 bath home has all the ex-
tras such as a full basement, freshly
painted, and 2 car garage. 462-1660

ANXIOUS SELLERS \$69,996
Have found another home and have
priced this wonderful home to sell.
Both the bath and kitchen were
recently remodeled. With a garage
and a finished basement, this home
has everything. 474-5700

The Prudential
Wolfe Realty
Independently Owned and Operated

CHRIS & CLEAN 3 bedroom, recent-
ly remodeled ranch, immediate occu-
pancy. Dining room with hard-
wood floors and bay window; newer
kitchen cabinets and sink; newer
bath vanity; basement w/partially
finished recreation room, 2 1/2 car gar-
age. Low down payment. Pleasant
S. Redford. \$69,900.

Century 21
One Way Realty
473-5500

FAMILY WANTED
for 3 bedroom 1 1/2 bath super sharp
ranch with finished basement, 2 1/2
car garage plus much more. FHA/
VA conventional. \$78,500.

WOLVERINE
PROPERTIES INC.
532-0600

REDUCED TO SELL
FHA/VA Terms. Sharp brick ranch
with finished basement, immediate occu-
pancy. Florida Room, 2 baths. Only
\$52,900.

APARTMENTS

400 Apts. For Rent
AMBER APARTMENTS
 GREAT VALUE!
 2 bedroom apts in Royal Oak
 Clawsen & Troy from \$505 per mo.
 Including Heat, Vertical Blinds,
 Dishwasher & More!
 Short Term Lease? Pets? Ask!
 280-1700

AUBURN HILLS
 Bloomfield Orchard Apts.
 Spacious 1 bedroom apartments
 from \$440.00. includes heat, gas &
 water. Blinds included. Pool + laundry
 facilities & more. Short term,
 furnished units available.
 Open 7 days.
 332-1848

400 Apts. For Rent
AUBURN HILLS
 Brand New Rentals
 2 Bedroom
 2 Bath
 With Washer & Dryer
 From \$610
 LOW MOVE-IN COSTS
BLOOMFIELD
VILLAS
 853-3335
 Mon.-Fri. 9-5 Sat.-Sun. 12-5

400 Apts. For Rent
APARTMENT
HOTLINE
 Use your phone
 to find a home.
FREE
 • 24 hours a day
 • All sizes, prices
 and cities
 • New listings daily
 691-7150

400 Apts. For Rent
 Birmingham
"BEAT THE FREEZE"
UP TO \$500 OFF
YOUR WINTER
HEATING BILL
 Call out with us at
 Buckingham Manor
 Receive 1 month free at
 Birmingham's finest rental
 community.
 Deluxe 2 bedroom apartments:
 • 1 1/2 baths
 • Lots of closet space
 • Full basement
 • Sparkling pool
 • Small pets welcome
 • Short term lease available
 • Short Term Corporate Suites
 Call Today
 649-6909
 You'll be glad you did!
 Certain Restrictions Apply
 Not valid with any other offer.

400 Apts. For Rent
★ APARTMENT
FINDERS
FREE
LOCATOR SERVICE
 • Save time & money
 • Hundreds of apartment
 locations thruout
 SE Michigan
 • Personalized attention to
 your housing needs
 Call Today
 for your
 New Apartment Home
 350-9262
 FOUR S.T.A.R. Network

400 Apts. For Rent
 BIRMINGHAM IN town location. On
 Henrietta. 1 bedroom flat, fireplace,
 garage, new kitchen, dishwasher &
 micro. Lease \$625. 647-7079

BIRMINGHAM lovely 1 bedroom
 \$525 month. Carpeted, newly
 decorated, balcony or patio.
 Credit report required. 301 N. Eton,
 N. of Maple. 649-1650

BIRMINGHAM - Near Downtown
 Large 2 bedrooms.
 Starting at \$565.
 649-2665

BIRMINGHAM - 2 bedroom, 1 1/2
 washer & dryer, vertical blinds. Near
 park. \$650/month. 253-9042

BIRMINGHAM - 2457 E. MAPLE
 1 bedroom, carpet, blinds, carport,
 central air, walk-in closet + secured
 building \$475. 643-4428

BIRMINGHAM
 Short-Term Lease
 Available for 1 month to 1 year
 elegantly furnished 1 bedroom unit.
 Perfect for transferred executive.
 Call:
DENNIS WOLF
 Licensed Broker
 Hal-Wolf Properties
 647-8100

BIRMINGHAM-2457 E. Maple. 1
 bedroom, carpet, blinds, carport,
 central air, walk-in closet + secured
 building \$500. 643-4428

BIRMINGHAM - 327 Southfield/
 Merrill. 1927 renovated 1 bedroom.
 Fireplace, hardwood floors. \$580
 includes heat. 339-1532. 642-9819

400 Apts. For Rent
 BIRMINGHAM - Lincoln & Wood-
 ward area. Studio apartment. Large
 walk-in closet, kitchenette, central
 air, & private patio/yard. Reserved
 parking. Only \$455 heat included.
 Sorry, no pets. Lease required.
 EHO. Call Karen for appointment at
 642-8686

BIRMINGHAM-343 Elm St. Unit A or
 B. 2 bedroom, 1 1/2 bath, hardwood
 floors, all appliances, 1 car garage,
 deck, \$950 each. 649-2703

BIRMINGHAM-343 Elm St. Unit A or
 B. 2 bedroom, 1 1/2 bath, hardwood
 floors, all appliances, 1 car garage,
 deck, \$950 each. 649-2703

BIRMINGHAM-343 Elm St. Unit A or
 B. 2 bedroom, 1 1/2 bath, hardwood
 floors, all appliances, 1 car garage,
 deck, \$950 each. 649-2703

BIRMINGHAM-343 Elm St. Unit A or
 B. 2 bedroom, 1 1/2 bath, hardwood
 floors, all appliances, 1 car garage,
 deck, \$950 each. 649-2703

400 Apts. For Rent
 BIRMINGHAM
 \$300 SECURITY DEPOSIT SPECIAL
 Newly remodeled 2 bedroom, 1 1/2
 bath, apt. available. E. of Adams
 Road near downtown Birmingham.
 Rental rates include heat & water,
 vertical blinds, new kitchen & appli-
 ances, mirrored floors & upgraded
 carpeting. Call Mon.-Sat. 644-1300

CANTON - SUBLEASE - Dec. thru
 July. 1 bedroom, \$425 month with
 heat. Off Joy Rd near expressway.
 Leave message. 416-8037

CLARKSTON - A 2 bedroom,
 quaint, Downtown apartment. Heat,
 water, stove, refrigerator, new car-
 pet. \$525. No dogs. 549-9281

400 Apts. For Rent
 BIRMINGHAM
LOW MOVE-IN COSTS
 \$300 Security Deposit
 \$337.50 First Month's Rent
 PLUS
 • Spacious 2 bedroom
 • GE Appliances
 • Blinds
 • Large Closets & Storage Area
 LINCOLN HILLS APARTMENTS
 645-2999

BIRMINGHAM
TIMBERLAKE APARTMENTS
 New! Exercise Room...
 444 Chester (at BROWN)
 IN HEART OF DOWNTOWN
 • Attractive Units
 • Vertical Blinds • Dishwasher
 • Microwave • Disposal • C/Air
 1 Bedroom - from \$580
 1 Mos. Free Rent 'til 11/25
 268-7766
 PM or Sat/Sun: 268-9806

BLOOMFIELD HILLS
FOX HILLS APARTMENTS
 Spacious 2 bedroom, 2 bath apart-
 ments now available featuring
 blinds, central air, swimming pool,
 and tennis court. All in a beautiful
 estate-like setting. From \$670.
 Off Opdyke Rd. just north of
 Square Lake Rd. at I-75.
 332-7400

Canton Garden Apts
 JOY ROAD EAST OF 275
 Spacious 1 bedroom townhouse, 2
 levels with private entrance, 1/2 bath
 down, full bath up. From \$475-\$495.
 • Stove & Refrigerator
 • Dishwasher & Disposal
 • Central Air/Heat
 • Verticals
 • Convenient Parking
 • Laundry facilities on premises
 • Pool & Clubhouse
 • No pets
 • \$400 rebate for new residents only!
 455-7440

CLAWSON/TROY
 New 1 bedroom, Casablanca fan,
 mini blinds, air, dishwasher, snack
 bar, must see. \$495/mo. 349-8685

DEARBORN HEIGHTS
 1 & 2 Bedroom Apts.
 From \$438*
 LOW MOVE-IN COSTS
 RIVER OAKS
 APARTMENTS
 271-4649
 Mon.-Fri. 9-5 Sat. 10-3
 *Limited time. First 6 months of a
 one year lease. New residents. Se-
 lect units.
 DEARBORN HTS
CAMBRIDGE APTS.
 Spacious 1 & 2 bedrooms, beautiful
 garden setting in a peaceful envi-
 ronment within walking distance to
 shopping, churches & restaurants
 CALL TODAY - ASK FOR SANDY
 274-4765
 York Properties, Inc.

DEARBORN WEST - Mich/Outer
 Dr., 22916 Cleveland. Clean carport,
 2 bedroom, basement, \$450 -
 utilities. No pets. 464-9465

COUNTRY HOUSE
 APARTMENTS
 1 bedroom apartment
 Heat & water paid
 Carpet & vertical blinds
 Pool & air conditioning
 Redford/Trip of Northern Detroit, bus
 transportation 533-1121
 Hrs Mon.-Fri. 9-5, by appointment.

DOWNTOWN DETROIT - Luxury
 high rise waterfront, sublease 2
 bedroom/2 bath. Available Dec. 1,
 \$990. Ask for Tom or Alena 588-7568

FARMINGTON HILLS
 ★ Rent Rollback Special
 On 1 Bedroom Apts.
 \$485
 Verticals/Carport included
 \$0 SECURITY DEPOSIT
 CEDARBROOKE APTS. 478-0322

GRAND RIVER - MIDDLEBELT
 GREAT LOCATION
 Clarendonville School District
CEDARIDGE
 Deluxe 2 Bedroom Units
 FROM \$500
 Limited time offer on selected units
 13 month lease. New tenants only.
 INCLUDES:
 Vertical blinds, carpeting, Hotpoint
 appliances, security system, storage
 within apartment.
 Enter on Tulane 1 block W. of
 Middlebelt on the S. side of Grand
 River.
 Near Botsford Hospital, Livonia Mall
 & downtown Farmington.
 471-5020
 Model open daily 1-5
 OFFICE: 775-8206

FARMINGTON DOWNTOWN - near
 Grand River. 1-2 bedroom, carpet-
 ing, heat included, no pets. From
 \$470. 360-3862

FARMINGTON HILLS - Maple Ridge
 Apartments, 23076 Middlebelt. Spaci-
 ous 1 & 2 bedrooms, 2 bath, air-
 conditioned, carport available.
 \$460-\$560. 473-5180

Stone Ridge
 "On the Water"
1 and 2 Bedroom Apartments from \$375

 "Less than 5 minutes from Novi & Farmington Hills"
 • Convenient to Twelve Oaks Mall
 • Cable TV Available
 • Dishwasher
 • Pool
 • Private Balcony/Patio
 • Variety of Floor Plans Available
 • Air Conditioning
 624-9445
 Open Monday-Friday 10-6, Sat. 10-5, Sun. 11-5

Windemere Apartments
LIVING YOU CAN AFFORD TO ENJOY
 • Central Air Conditioning
 • Convenient To Shopping And Expressways
 • Cable TV Available
 • Private Balcony/Patio
 • Kitchen With Open Bar Counter
 • Dens Available
 • 1 1/2 Baths Available
 • And More... Visit Us And See For Yourself!
 On Halsted 1/2 Mile North of Grand River in Farmington Hills
FROM \$475

 OPEN Mon. - Fri. 9-6; Sat. 10-5; Sun. 12-5
 471-3625

Oak Village
 2758 Ackley
 Westland
721-8111
 "Family Living At It's Best"
 Two bedroom, one bath duplex ranch
 homes with full basements.
\$495
 • On-site management • Spacious yards
 • On-site maintenance • Gas ranges, frost
 free refrigerators
 • Lawn cutting • Snow removal
 • One small pet
 Open Mon.-Fri. 9-7 Sat. 10-5 Sun. 12-5

The Village APARTMENTS
LIVING YOU CAN Afford To Enjoy!
1 & 2 BEDROOM APARTMENTS FROM \$360 HEAT INCLUDED
 Beautiful Setting in a Great Location!

 • Swimming Pool
 • Air Conditioning
 • Social Activities
 Models Open Mon.-Sat. 9-6 Sun. 11-5
624-6464

HILLSIDE APARTMENTS
NOW LEASING!
NEW ONE & TWO BEDROOM APARTMENTS FROM \$500

LAKEFRONT APARTMENTS FEATURING:
 • HEAT INCLUDED IN RENT
 • Washer & Dryer in Every Apartment
 • Cathedral Ceilings with Unique Accent Windows Available
 • Swimming Pool and Clubhouse
LEASING OFFICE OPEN
 Mon.-Fri. 10-6 • Sat. 10-5 • Sun. 11-5
624-6480

THE GATE TO GREAT LIVING!
Golden Gate APARTMENTS
 From \$380

 • Great Location
 • Spacious Apartments
 • Swimming Pool
 • Central Air Conditioning
 • All this and More...
 Come and See for Yourself!
 On Pontiac Trail just West of Beck Road
 Mon. - Fri. 10-6 • Sat. 10-5 • Sun. 11-5
624-1388

Warren & Middlebelt Area
WESTLAND PLAZA APTS.
 Nice place to live!
 Near bus line
Come look us over!
Spacious 1 and 2 Bedroom
\$450 & \$495
Heat and Water Included
427-1997

Westland
 Newburgh near Glenwood
LIMITED TIME
2 Bedroom - \$440**
1 Bedroom - \$405**
 \$300.00 Security Deposit
 Vertical Blinds • Pool • Carport
 Monday-Friday 8:30-5:30
729-5090
 *Subject to change without notice.
 New tenants only.

Ask About Our Specials
WOODCREST VILLA
APARTMENTS & ATHLETIC CLUB
 Spacious 1 & 2 bedroom apartments, each with
 a fireplace, mini-blinds and balcony or patio.
 Private athletic club featuring year-round
 indoor-outdoor pool, sauna, steam bath,
 whirlpool and exercise room. Secured setting
 amidst woods and duck ponds. Pets welcome.
 Senior citizen discount.
261-8010
 CONVENIENTLY LOCATED OFF WAYNE RD.
 BETWEEN WARREN & JOY, NEAR THE WESTLAND SHOPPING MALL.
 RENTAL OFFICE AND MODEL OPEN TO A.M.-6 P.M.
IMMEDIATE OCCUPANCY

Novi
PAVILION COURT
 Luxury made affordable
2 BEDROOMS
 from \$705 including carport
1 Month Free
 • Fully Equipped Health Club
 • Washer and Dryer in Each Unit
 On Haggerty Road
348-1120
 Daily 9-7 Sat. 11-5

Tired Of Looking At The Same Four Walls?

FARMINGTON
CHATHAM HILLS
 One Month Free
 • Indoor Pool • Extra Large Apts.
 • Attached Garages • Dishwashers
 On Old Grand River Between Drake and Halstead
476-8080
 Daily 9-7 Sat. 11-5

PLYMOUTH/CANTON
VILLAGE SQUIRE
 One Month Free
 \$200 Security Deposit
 Suites from \$450
 Includes Heat
 • Pool and Saunas • Pet Section Available
 Vertical Blinds • Basketball and Tennis Courts
981-3891
 On Ford Road, just East of I-275
 Daily 9-7 Sat. 11-6 Sun. 11-5

COLLECT ONE MONTH'S FREE RENT
 At Many Locations!
 Call for Details!

Call 644-1300 for information
FTION SQUARE APARTMENTS TOWNHOUSES
 Models Open Daily and Weekends
 What rental communities were meant to be!

WESTLAND
HAWTHORNE CLUB
 Live One Month Free
 Suites from \$445
 Includes Heat
 • Vertical Blinds
 • Pet Section
 • Short term leases available
 • Microwaves
 522-3364
 7560 Merriman
 Between Ann Arbor Tr. & Warren
 Daily 9-6 Sat. & Sun. 12-4

Tired Of Playing The Moving Game...
Win With A Consolidated Management Inc. Community!
IT'S YOUR MOVE!
 We have a Monopoly on the best locations and values!
WE CARE
 Don't Take A Chance Living Elsewhere
SPECIALS
 Our Community Chest is Full of Specials!

PLYMOUTH/CANTON
FRANKLIN PALMER ESTATES
 One Month Free
 Suites from \$450
 Includes Heat
 • Pet Section Available
 • Short Term Lease
397-0200
 On Palmer, West of Lilly
 Daily 9-7 Sat. & Sun. 12-4

WESTLAND
HUNTINGTON On The Hill
 Two Bedroom Special
 From \$695 Now \$495
 \$200 Security Deposit
 Includes Heat
 • Spacious Suites
 • Vertical Blinds
 • Dishwashers
 • Park Setting
 425-8070
 Ann Arbor Tr. W. of Middlebelt Rd.
 Daily 9-7 Sat. 10-3 Sun. 12-4

DEARBORN HEIGHTS
DEARBORN CLUB
 One Bedroom Special
 \$200 Security Deposit
 One Month Free
 Suites from \$460
561-3593
 On Inkster just north of Ford Road
 Daily 12-7 Sat. 12-4

ROCHESTER
ROCHESTER SQUARE APTS.
 One Month Free
 \$200 Security Deposit
 Includes Heat
 • Air Conditioned • Laundry Facilities
 • Dishwashers • Picnic Area
652-0543
 675 Main Street
 Daily 9-6 Sat. 12-4

PLYMOUTH/CANTON
HILLCREST CLUB
 One Month Free
 Suites from \$475
 Includes Heat
 • Pet Section Available
 • Short Term Leases Available
453-7144
 12350 Risman
 S. of Plymouth Rd., E. of Haggerty
 Daily 9-7 Sat. & Sun. 12-4

GO
 To A Better Lifestyle

YOU WIN WITH OUR VALUES!
\$

Splish! Splash!
 All Year Long In Our Indoor Pool!
 Plus Enjoy
 • Tennis Courts
 • Panoramic Balcony Views
 • Controlled Access
 • Community Room
 • High-Rise Living
 And, You Won't Be Left Out In The Cold With Our
FREE HEAT!
721-2500
 Hunters West 1 & 2 bedroom highrise
 luxury apartments include the features
 you'll love, plus convenient access to
 I-275, Detroit & Ann Arbor.
 Models open daily.
 Hunters West is located one block west of Wayne Rd. between
 Ford and Warren Roads.
Just \$199 Moves You In!

Great Living - SUPER Value!
Scotsdale Apartments
1 BEDROOM from \$440
2 BEDROOM from \$510
 Newburgh between Joy & Warren
\$250 Deposit & Dishwashers in selected units
 FREE HEAT and COOKING GAS
 Vertical Blinds • 1 1/2 Baths • Central Air
 • Pool • Laundry & Storage
 • Tennis • Carport • Clubhouse • Cable Ready
 Equal Opportunity Housing
455-4300

FARMINGTON HILLS
BOTSFORD PLACE
GRAND RIVER - 8 MILE
 Behind Botsford Hospital
SPECIAL
 1 Bedroom for \$449
 2 Bedroom for \$559
 3 Bedroom for \$669
PETS PERMITTED
 Smoke Detectors Installed
 Singles Welcome
 Immediate Occupancy
 We Love Children
HEAT & WATER INCLUDED
 Quiet prestige address, air condi-
 tioning, carpeting, stove & refrigera-
 tor, all utilities except electricity in-
 cluded. Warm apartments. Laundry
 facilities.
 For more information, phone
 477-8464
 27883 Independence
 Farmington Hills

FARMINGTON HILLS
\$499 Moves You In
 (On Selected Units)
 1600 sq. ft. 2 bedroom garden
 apartments. 2 bath w/walk-
 in closets, covered parking, washer/
 dryer, vertical blinds, attended gate-
 house, and a 24 hour monitored in-
 trusion and fire alarm.
 Rent from \$665
SUMMIT APTS.
 NORTHWESTERN & MIDDLEBELT
 626-4396
 Managed by Kattian Enterprises, Inc.
FARMINGTON HILLS
 Very Large 1 bedroom with separate
 inside storage room, from \$455
FREE HEAT 471-4555

FARMINGTON HILLS
ORCHARD CREEK APARTMENTS
 1300 sq. ft. 2 bedroom/2 bath with
 individual entrances, gas fireplace,
 GE appliances including washer/
 dryer, monitored fire & intrusion
 alarm plus much more...
ONE MONTH FREE
 (new residents only)
 Located on Orchard Lake Rd.
 1/2 mile south of 14 Mile

FARMINGTON HILLS - 1 bedroom,
 w/washer/dryer, golf course view.
 Goes for \$489. Renting for \$450/mo.
 Days 337-1475 Even. 471-1118

APARTMENTS

400 Apts. For Rent
FAIRMONT PARK APARTMENTS FALL SAVINGS

Save up to \$50 PER MONTH on our large 1 and 2 bedroom, 2 bath apartments!

- Private Entrance
- 800-1250 sq. ft.
- Washer & Dryer
- Eat in kitchen space
- Large storage room
- Vertical blinds
- Carports included

IMMEDIATE OCCUPANCY
 474-2510
 9 Mile & Drake
 Offer expires 11-30-92
 Applies to new Residents
BEST APARTMENT VALUE

FARMINGTON HILLS
TIMBERIDGE

DELUXE 2 BEDROOM UNITS From \$500
 Limited time offer on select units. New tenants only. 13 month lease.

Includes appliances, vertical blinds, carpeting, pool, close in Farmington Hills location.

Enter East of Orchard Lake Rd. on Folsom S. of Grand River. Model Open Daily 9-5 Except Wednesday
 478-1487 775-8206

FARMINGTON HILLS
2,000 SQ. FT. OF PURE LUXURY
 Elegantly designed 2 or 3 bedroom ranch, or 3 bedroom townhouses, 2+ baths, whirlpool tub, full basement, 2 car attached garage. From \$125.

COVINGTON CLUB
 14 Mile & Middlebelt
 851-2730
 Managed by Kaffen Enterprises Inc.

FARMINGTON HILLS
\$699 MOVES YOU IN
 On selected units
 1500 sq. ft. 2 and 3 bedroom townhouses. 2+ baths, spacious master bedrooms, walk-in closets, washer/dryer, blinds and covered parking.
 RENT FROM \$930

FOXPOINTE
 HALSTED & 11 MILE
 477-1127
 Managed by Kaffen Enterprises, Inc.

FARMINGTON - large 2 bedroom.
 We're moving, must break lease. Rents for \$675 but will sub-lease for \$620.
 477-9074

FARMINGTON - LARGE 2 bedroom
 town home, contemporary decor, track lighting, large living room, fireplace, wet bar, cathedral ceiling, built-in sound system and much more \$1,200. Call 474-6082

FARMINGTON MANOR - Only \$150
 security deposit. Newly decorated studio & 1 bedroom apts. from \$400. Central heat & air, appliances, vertical blinds, carpet, laundry facilities. Secured entrance door, Carports available. No pets. 474-2552

FARMINGTON - Quiet complex.
 1 bedroom, \$485/mo. 2 bedroom, 2 bath, \$570/mo. includes heat, water & carport.
 477-5650

Senior Citizens Applications Available
 For Our Waiting List
 Rent Based on Income
 1 & 2 bedroom apts.
 UTILITIES INCLUDED
 Visit or Call:
FARMINGTON PLACE
 32900 Grand River Farmington
 478-8544
 Handicapped-Disabled Not Discriminated
 Equal Housing Opportunity

FARMINGTON - \$350/mo. 1 non-smoker, walk-out 1st level into woods through glass doors, limited cooking.
 477-1189

FENTON ST 1 bedroom - \$380
 2 bedroom - \$480. Includes heat & water. Half month rent free.
 255-0073

GARDEN CITY - Large 1 bedroom,
 freshly painted appliances, carpeting, air, cable, laundry, no pets. \$425. Agent.
 Call: 1-313-522-0420

GARDEN CITY
 Ford/Middlebelt Area
 Spacious 1 bedroom apartments. Amenities include:
 • Owner Paid Heat & Water
 • Central Air
 • Intercom System
 • Garbage Disposal
 • Laundry Facilities
 • Window Treatments/Mini Blinds
 From \$390 monthly
 CALL ABOUT FALL SPECIAL
GARDEN CITY TERRACE
 522-0480

GARDEN CITY - Large 1 bedroom,
 freshly painted appliances, carpeting, air, cable, laundry, no pets. \$395. Agent.
 Call: 1-313-522-0420

400 Apts. For Rent
FARMINGTON
 \$485 MOVES YOU IN on selected units
FREE HEAT - Large 1 & 2 bedrooms. Clean, quiet community, Orchard Lake Rd., N. of 8 Mile.
VILLAGE OAKS
 474-1305
 Managed by Kaffen Enterprises, Inc.

FERNDALE
 Spacious 1 bedroom with balcony 1/2 mile from 696. \$425 per month. Lease negotiable. 655-4620

GARDEN CITY - decorated, 1 bedroom,
 shopping, appliances & heat furnished. \$415 plus security. 464-3847 or 421-2146

GARDEN CITY, 1 bedroom, \$430
 plus security, utilities, heat & water included. No pets. 565-3677

GARDEN CITY 1 & 2 bedroom from
 \$415 mo. + \$300 security, includes heat, water, appliances, air, laundry facilities. 421-7765 or 553-2165

GARDEN CITY - 2 large bedrooms,
 carpeted, air, balcony, appliances, heat paid. \$450 per month. After 6pm 851-8219

LAKE ORION
 Small 2 bedroom apt. \$425 per month includes heat and appliances. Call after 5pm, 313-673-0316

Livonia
CURTIS CREEK APARTMENTS
 FARMINGTON RD. AT 6 MILE
 1 Bedroom - \$539 to \$569
 2 Bedroom - \$629 to \$649
 Includes Private Entrance, Vertical Blinds, Appliances, Central Air, Washer & Dryer
 473-0365

Livonia
HAVE A WONDERFUL HOLIDAY AT WOODRIDGE APTS
 Receive up to \$500 off your winter heating bill at Livonia's finest rental community. Spacious 1 bedroom & beautiful 2 bedroom, 2 bath apts.
 • Free Carport
 • Vertical Blinds
 • Storage Room inside apt.
 • Sparkling Pool
 • Playground
 • Picnic Area
 • Minutes from Livonia Mall
 • Luminous Schools
 • Convenient Expressways
 • Pets Welcome
 • Furnished Corporate Suites
 477-6448
 On Middlebelt between 6 & 7 Mile Mon. thru. Fri. 8:30 - 5:00
 Sat. 10:30 to 4 & by appointment
 Certain Restrictions Apply
 Not valid with any other offer

LIVONIA - Spacious 1 & 2 bedroom
 apartments in lovely park setting. Convenient to shopping. Specials available to qualified applicants. Starting at \$425/mo. Appointments available, 9-5pm days. 425-5380

FALL SPECIAL CONCORD TOWERS
 1 & 2 BEDROOM APARTMENTS includes:
 • Stove & refrigerator
 • Dishwasher
 • Carport
 • Intercom
 • Newly decorated
 • Smoke detectors
 • Sprinkler system
 • FROM \$405
 1-75 and 14 Mile
 Next to Abbey Theater
 589-3555

Livonia
 Madison Heights
FALL SPECIAL CONCORD TOWERS
 1 & 2 BEDROOM APARTMENTS includes:
 • Stove & refrigerator
 • Dishwasher
 • Carport
 • Intercom
 • Newly decorated
 • Smoke detectors
 • Sprinkler system
 • FROM \$405
 1-75 and 14 Mile
 Next to Abbey Theater
 589-3555

Livonia
 Northville
THE BENECKE GROUP
 348-9590

400 Apts. For Rent
LIVONIA - 7 MILE RD.
 1 & 2 Bedroom Starting at \$575
 Includes washer & dryer in each apartment. Carpeting, vertical blinds, deluxe appliances, balcony, patio, swimming pool, tennis courts, community room. Near shopping.
CANTERBURY PARK
 7 mile rd., corner of 7 mile between Farmington & Merriman Rds.
 473-3983 775-8206
 Model open daily 9-5 except Wednesday

MADISON HEIGHTS
GREAT APTS. GREAT LOCATIONS
 \$50 Security Deposit For 1 Bedroom Apts.
RENT INCLUDES Heat & Vertical Blinds
CALL FOR SUPER SPECIAL ON FIRST MONTH'S RENT
 6 month or 1 year lease. Well maintained. Newly decorated. Features: Air conditioning, refrigerator, range, smoke detectors, laundry facilities & extra storage. Swimming pool. Cable available.

ALSO 2 BEDROOM APTS.
LEXINGTON VILLAGE
 PET SECTION AVAILABLE
 1 bedroom apts. from \$445 -1-75 and 14 Mile
 Opposite Oakland Mall
 585-4010

PRESIDENT MADISON APTS.
 1 Bedroom Apts. \$450
 1 Block E. of John R.
 1 Block S. of Oakland Mall
 585-0580

HARLO APTS.
 1 Bedroom Apt. \$450
 Warren, Mich.
 West side of Mount Rd.
 Just N. of 13 Mile
 Not valid with any other offer
 Opposite GM Tech Center
 939-2340

NORTHVILLE AREA. 1 & 2 bedroom
 apartments available \$520 to \$600 per month including heat. 1 year lease. Please call 348-9250

NORTHVILLE 1 bedroom apartment
 near downtown. Quiet, natural setting. \$520 includes heat & water. Immediate occupancy. 347-6565

N. DEARBORN HEIGHTS - Ann Arbor
 Trail. Large 2 bedroom apartment, carpeting, air, appliances, no pets. \$450/mo. 565-8093

OAKLAND County Mansion
 servent's apt. with large kitchen, bay window living room, 2 bedrooms & study, on over 3 acres magnificent grounds. Certain restrictions. \$550 includes utilities. Even. 647-1135

Plymouth
'BEAT THE FREEZE' UP TO \$500 OFF
 Your Winter Heating Bill At TWIN ARBORS
 Beautiful 1 & 2 bedroom apartments minutes away from Downtown Plymouth yet secluded in a quiet residential neighborhood
 • Extra Storage Space
 • Large Balconies
 • Beautiful Pool
 • Almost 1000 sq. ft. of living space
 • Furnished Corporate Suites
 453-2800
 Mon. - Fri. 9 - 5:00
 Saturday 10 - 4
 & by appointment
 Certain Restrictions Apply
 Not valid with any other offer

- PLYMOUTH - BROUGHAM MANOR
 1 & 2 BEDROOMS
 Starting from \$435
 1 yr. Lease. Heat & Water included
 Call Mon-Sat. 10-6
 455-1215

FOUNTAIN PARK
 South side of Grand River, between Meadowbrook & Novi Rds.
 348-0626
 Hours: Mon.-Fri. 10:30-6:30
 Sat. & Sun. Noon-5
 (small pets welcome)

THE BENECKE GROUP
 348-9590

400 Apts. For Rent
NOVI
AWESOME 2 BEDROOM PRICES!!! AT NOVI RIDGE
 Huge Beautiful 1 & 2 bedroom apts. Too good to be true? Wait, there's more...
 • Vertical Blinds
 • Beautiful Kitchens
 • Private Patio/Balcony
 • Exciting New Clubhouse w/large screen TV & video library
 • Exercise Room w/sauna
 • Sparkling Pool/Tennis Courts
 • Novi Schools
 • Convenient Expressways
 • Pets welcome
 • Furnished Corporate Suites
 349-8200
 (on 10 Mile between Novi & Meadowbrook Rds.)
 Hours: Mon. - Fri. 8:30 - 5:00
 Sat. 10 - 4 & by appointment
 Certain Restrictions Apply
 Not valid with any other offer

NOVI
 1 bedroom apts. from \$445 -1-75 and 14 Mile
 Opposite Oakland Mall
 585-4010

NOVI
 1 bedroom apts. from \$445 -1-75 and 14 Mile
 Opposite Oakland Mall
 585-4010

NOVI
 1 bedroom apts. from \$445 -1-75 and 14 Mile
 Opposite Oakland Mall
 585-4010

NOVI
 1 bedroom apts. from \$445 -1-75 and 14 Mile
 Opposite Oakland Mall
 585-4010

NOVI
 1 bedroom apts. from \$445 -1-75 and 14 Mile
 Opposite Oakland Mall
 585-4010

NOVI
 1 bedroom apts. from \$445 -1-75 and 14 Mile
 Opposite Oakland Mall
 585-4010

NOVI
 1 bedroom apts. from \$445 -1-75 and 14 Mile
 Opposite Oakland Mall
 585-4010

NOVI
 1 bedroom apts. from \$445 -1-75 and 14 Mile
 Opposite Oakland Mall
 585-4010

NOVI
 1 bedroom apts. from \$445 -1-75 and 14 Mile
 Opposite Oakland Mall
 585-4010

NOVI
 1 bedroom apts. from \$445 -1-75 and 14 Mile
 Opposite Oakland Mall
 585-4010

NOVI
 1 bedroom apts. from \$445 -1-75 and 14 Mile
 Opposite Oakland Mall
 585-4010

NOVI
 1 bedroom apts. from \$445 -1-75 and 14 Mile
 Opposite Oakland Mall
 585-4010

400 Apts. For Rent
LIVONIA'S FINEST LOCATION
 Merriman corner 7 mile Near Livonia Mall
 Deluxe 1 & 2 bedroom units immediate Occupancy
 From \$525
 Limited time offer on these reduced rates. New tenants only.
 Vertical blinds
 Patio or balcony
 Pool
MERRIMAN WOODS
 Model open 9-5 except Thursday
 477-9377 Office: 775-8206
 (on 10 Mile between Novi & Meadowbrook Rds.)
 Hours: Mon. - Fri. 8:30 - 5:00
 Sat. 10 - 4 & by appointment
 Certain Restrictions Apply
 Not valid with any other offer

PLYMOUTH - Desirable 1 bedroom
 apartment. Carpeting, appliances, heat & water. Walk to town. \$430/mo. + deposit. 455-1816

PLYMOUTH - downtown, 1 bedroom,
 laundry, storage, walk in closets, central air, balcony, carport, newer complex. \$450. 455-4556

PLYMOUTH HERITAGE APTS
 (N. Territorial, W. of Sheldon)
 • SPECIAL •
 1st month rent FREE + 13 month lease + \$25 discount off each month's rent, with presentation of ad at time of application. *
 Quality 1 bedroom apts available. Rent \$445, includes heat & water.
 Call For Super Special Rates! 455-2143
 * upon credit approval.

PLYMOUTH LIVE ON THE PARK
 40315 PLYMOUTH RD. Manager #101
SPECIAL!
 \$50 OFF ON 1 BEDROOM FOR 6 MONTHS
 1 BEDROOM, \$460
 2 BEDROOM, \$490
 ONE MONTH FREE RENT SENIOR DISCOUNT
 Amenities include:
 • Heat & water
 • Appliances
 • Carpeting & blinds
 • Laundry facilities
 • Central air & pool
 • Security
 455-3682
 Plymouth Rd., near I-275

PLYMOUTH Hills Apartments
 746 S. Mill St.
 Between Ann Arbor Tr. / Ann Arbor Rd.

PLYMOUTH
 • Washer/Dryer in each unit
 • Window Treatments
 • Easy Access to I-275
 • Air Conditioned
 • Dishwasher
 • Walk to Downtown
 • 1 & 2 Bedroom
 455-4721 12-5pm

PLYMOUTH - 1 bedroom, \$475 plus
 utilities. Half month security deposit. 303 Roe St, walking distance from downtown. Mon-Fri 9-5, 582-0450, Even/weekends 416-1418

PLYMOUTH - 1 MONTH FREE RENT AFFORDABLE SPECIALS!
 Senior citizen, adult community. Spacious 1 & 2 bedroom apartments in quiet community. Walk to shopping. Central air, dishwasher, vertical blinds, carport. Available to qualified applicants.
 453-8811

PLYMOUTH - 1 bedroom, \$475 plus
 utilities. Half month security deposit. 303 Roe St, walking distance from downtown. Mon-Fri 9-5, 582-0450, Even/weekends 416-1418

PLYMOUTH - 1 MONTH FREE RENT AFFORDABLE SPECIALS!
 Senior citizen, adult community. Spacious 1 & 2 bedroom apartments in quiet community. Walk to shopping. Central air, dishwasher, vertical blinds, carport. Available to qualified applicants.
 453-8811

PLYMOUTH - 1 MONTH FREE RENT AFFORDABLE SPECIALS!
 Senior citizen, adult community. Spacious 1 & 2 bedroom apartments in quiet community. Walk to shopping. Central air, dishwasher, vertical blinds, carport. Available to qualified applicants.
 453-8811

PLYMOUTH - 1 MONTH FREE RENT AFFORDABLE SPECIALS!
 Senior citizen, adult community. Spacious 1 & 2 bedroom apartments in quiet community. Walk to shopping. Central air, dishwasher, vertical blinds, carport. Available to qualified applicants.
 453-8811

PLYMOUTH - 1 MONTH FREE RENT AFFORDABLE SPECIALS!
 Senior citizen, adult community. Spacious 1 & 2 bedroom apartments in quiet community. Walk to shopping. Central air, dishwasher, vertical blinds, carport. Available to qualified applicants.
 453-8811

PLYMOUTH - 1 MONTH FREE RENT AFFORDABLE SPECIALS!
 Senior citizen, adult community. Spacious 1 & 2 bedroom apartments in quiet community. Walk to shopping. Central air, dishwasher, vertical blinds, carport. Available to qualified applicants.
 453-8811

PLYMOUTH - 1 MONTH FREE RENT AFFORDABLE SPECIALS!
 Senior citizen, adult community. Spacious 1 & 2 bedroom apartments in quiet community. Walk to shopping. Central air, dishwasher, vertical blinds, carport. Available to qualified applicants.
 453-8811

PLYMOUTH - 1 MONTH FREE RENT AFFORDABLE SPECIALS!
 Senior citizen, adult community. Spacious 1 & 2 bedroom apartments in quiet community. Walk to shopping. Central air, dishwasher, vertical blinds, carport. Available to qualified applicants.
 453-8811

PLYMOUTH - 1 MONTH FREE RENT AFFORDABLE SPECIALS!
 Senior citizen, adult community. Spacious 1 & 2 bedroom apartments in quiet community. Walk to shopping. Central air, dishwasher, vertical blinds, carport. Available to qualified applicants.
 453-8811

PLYMOUTH - 1 MONTH FREE RENT AFFORDABLE SPECIALS!
 Senior citizen, adult community. Spacious 1 & 2 bedroom apartments in quiet community. Walk to shopping. Central air, dishwasher, vertical blinds, carport. Available to qualified applicants.
 453-8811

PLYMOUTH - 1 MONTH FREE RENT AFFORDABLE SPECIALS!
 Senior citizen, adult community. Spacious 1 & 2 bedroom apartments in quiet community. Walk to shopping. Central air, dishwasher, vertical blinds, carport. Available to qualified applicants.
 453-8811

PLYMOUTH - 1 MONTH FREE RENT AFFORDABLE SPECIALS!
 Senior citizen, adult community. Spacious 1 & 2 bedroom apartments in quiet community. Walk to shopping. Central air, dishwasher, vertical blinds, carport. Available to qualified applicants.
 453-8811

PLYMOUTH - 1 MONTH FREE RENT AFFORDABLE SPECIALS!
 Senior citizen, adult community. Spacious 1 & 2 bedroom apartments in quiet community. Walk to shopping. Central air, dishwasher, vertical blinds, carport. Available to qualified applicants.
 453-8811

PLYMOUTH - 1 MONTH FREE RENT AFFORDABLE SPECIALS!
 Senior citizen, adult community. Spacious 1 & 2 bedroom apartments in quiet community. Walk to shopping. Central air, dishwasher, vertical blinds, carport. Available to qualified applicants.
 453-8811

PLYMOUTH - 1 MONTH FREE RENT AFFORDABLE SPECIALS!
 Senior citizen, adult community. Spacious 1 & 2 bedroom apartments in quiet community. Walk to shopping. Central air, dishwasher, vertical blinds, carport. Available to qualified applicants.
 453-8811

PLYMOUTH - 1 MONTH FREE RENT AFFORDABLE SPECIALS!
 Senior citizen, adult community. Spacious 1 & 2 bedroom apartments in quiet community. Walk to shopping. Central air, dishwasher, vertical blinds, carport. Available to qualified applicants.
 453-8811

PLYMOUTH - 1 MONTH FREE RENT AFFORDABLE SPECIALS!
 Senior citizen, adult community. Spacious 1 & 2 bedroom apartments in quiet community. Walk to shopping. Central air, dishwasher, vertical blinds, carport. Available to qualified applicants.
 453-8811

PLYMOUTH - 1 MONTH FREE RENT AFFORDABLE SPECIALS!
 Senior citizen, adult community. Spacious 1 & 2 bedroom apartments in quiet community. Walk to shopping. Central air, dishwasher, vertical blinds, carport. Available to qualified applicants.
 453-8811

PLYMOUTH - 1 MONTH FREE RENT AFFORDABLE SPECIALS!
 Senior citizen, adult community. Spacious 1 & 2 bedroom apartments in quiet community. Walk to shopping. Central air, dishwasher, vertical blinds, carport. Available to qualified applicants.
 453-8811

PLYMOUTH - 1 MONTH FREE RENT AFFORDABLE SPECIALS!
 Senior citizen, adult community. Spacious 1 & 2 bedroom apartments in quiet community. Walk to shopping. Central air, dishwasher, vertical blinds, carport. Available to qualified applicants.
 453-8811

PLYMOUTH - 1 MONTH FREE RENT AFFORDABLE SPECIALS!
 Senior citizen, adult community. Spacious 1 & 2 bedroom apartments in quiet community. Walk to shopping. Central air, dishwasher, vertical blinds, carport. Available to qualified applicants.
 453-8811

400 Apts. For Rent
 Meadowbrook & 10 Mile
TREE TOP MEADOWS
 Now's the time...
 With a location this convenient and value this outstanding, apartments are going fast. You can be living in a spacious one or two bedroom apartment with oversized rooms, large balcony/patio, central air, vertical blinds, plush carpeting, covered parking and MORE! Close to every convenience with shopping, dining, and access to expressways just minutes away. This is the best value in an apartment you've seen in a long time. Lease EHO.
 One bedroom from \$555
 Two bedroom from \$625
 Call for an appointment
THE BENECKE GROUP
 348-9590

ROCHESTER-DOWNTOWN
 Upstairs 2 bedroom apartment, furnished upon request. \$550. Please call. 651-6447

Charles Hamlet Apts.
1st mo. Rent FREE
 1 bedroom \$530
 2 bedroom \$550
 Mon.-Fri. 9-5, Sat. 10-4
 Sun. 11-4
 652-0311

ROCHESTER/75, One bedroom
 apt. 800 sq. ft. with balcony, pool, jacuzzi, sauna, gym. Appliances included. Tenant lease \$540/month. Call Friday up to 4pm. 453-3757

ROCHESTER
OAK HILL APARTMENTS
 Now accepting applications for apartments and townhouses.
 1 bedroom, \$435. 2 bedroom, \$495. 2 includes heat & water.
 Mon. Wed. Fri. 11:30-6
 Sat. 10-1pm. 651-9751

Romulus
OAKBROOK VILLA
 2 and 3 bedroom Townhouses Ranging from \$399 to \$500 Includes all utilities
 Open Mon., Wed., Fri. 9am-5pm
 Tues. & Thurs. 9am-6pm
 Sat. 11am-2pm Closed Sun.

15001 BRANDT 941-4057
ROYAL OAK - Beautiful luxury
 3 bedroom apt., 2 baths, living room, dining room, central air & heat, carpeting. \$725. Call 644-3122

ROYAL OAK, female for efficiency
 apt. in exclusive Royal Oak area. Slove, fridge, \$425/mo. includes utilities. No pets. Immediate occupancy. Call Mon.-Fri. 9-5PM, 398-1859. After 5: 546-2925

ROYAL OAK - LOOK NO FURTHER
 \$395 month/\$150 security. Only 2 left!
 Westwood Apartments. 357-3777

Royal Oak NORTHWOOD APARTMENTS
 \$200 Security Deposit
 1 Month's Free Rent
 1 bedroom starting at \$450
 2 bedroom starting at \$450
 Call 541-3332

ROYAL OAK - North. 1 bedroom
 near I-75. Immediate occupancy. \$395 per month, heat & water included. 641-0265 or 754-3438

ROYAL OAK/TROY
 Doggy, Doggy, where will you live? At Amber Apartments Permission they give! SPECIALS, TOO!
 280-1700

ROYAL OAK Commuter Apt. \$40
 Sherman, off 11 Mile, near 696 & I-75. 1 bedroom, clean, spacious, appliances, fireplace, patio. 464-6042

ROYAL OAK - 13 & Greenfield.
 immaculate 1 bedroom with all modern features. Small exclusive complex, 1 yr. lease, \$400/mo. + security. 553-4466 or 653-3218

SOUTHFIELD, BEAUTIFUL PARK SETTING.
 On river banks, 1-2 bedroom. Vertical blinds, carpet, appliances. Dishwasher, washer, carports. \$495-\$625 monthly. Telegraph-Southfield. 354-3362

SOUTHFIELD CHARTERHOUSE APARTMENTS
 1 Month's Free rent/Free Cable Upscale Hi-rise apartments Studio, 1 & 2 Bedrooms starting at \$400. Pool, Tennis Courts and much more. Call now 557-8100 Located on 9 Mile/Greenfield

SOUTHFIELD COUNTRY CORNER APTS
 We're BIG on Square Foot!
 1 bedroom: 1100 sq. ft.
 2 bedroom: 1300

RENTALS

400 Apts. For Rent

WHITEHALL APARTMENTS
1 MONTH'S FREE RENT
Spacious 2 Bedroom Apts.
Starting at \$660. Free Cable & Heat on selected units. Call now 557-0311. Conveniently Located on 1/2 Mile Greenway.

SOUTHFIELD
\$399 MOVES YOU IN
On selected units
• FREE HEAT
• Clean, quiet 1 bedroom
• Walk-in closets
• Covered parking
• 24 hr. monitored intrusion alarm FROM \$355

12 Mile & Lahar
TWYCKINGHAM VALLEY
358-4423
Managed by Kalfan Enterprises, Inc.

SOUTHFIELD
30 days RENT FREE*

Luxury 1 & 2 bedroom apts. Private in-suite washer & dryer, open kitchen with eating space, self defrosting refrigerator, self cleaning oven, washer, vertical blinds, carpet, in-lacorty, clip-ports.

400 Apts. For Rent

TROY/CLAWSON
New England Place Apts.
Spacious 2 bedroom apts. located 2 1/2 miles of Farmington. Includes carpeting, heat, water, air conditioning, dishwasher, disposal, cable ready, laundry facilities on-site.
12' x 15' storage area, \$570/mo. Some with fireplace - \$590/mo.
NO SECURITY DEPOSIT REQUIRED
(313) 435-5430

Troy/Royal Oak Area
SPECIALS
at Amber Apartments
280-1700

TROY
SOMERSET AREA - FROM \$495
Studio and spacious 1 & 2 bedroom apartments. Amenities include:
• Owner Paid Heat
• Swimming Pool
• Laundry Facilities
• Balconies or Patios
• Intercom
• Dishwashers
• Disposals
• Air Conditioning
• Window Treatments/Vertical Blinds
• Close to Shopping & Expressways
VILLAGE APARTMENTS
362-6248

WAYNE/DOWNTOWN
Holiday Special
2 bedroom, \$410/mo. 1 bedroom \$375/mo. \$200 security deposit.
Call: 728-2480

WAYNE/DOWNTOWN
Holiday Special
2 bedroom \$410/mo. 1 bedroom \$375/mo. \$200 security deposit.
Call: 728-2480

WAYNE/WESTLAND Holiday Special
Spacious 1 & 2 bedroom, attractive 1 bedroom on Newburgh Rd. Cats OK. \$200 security deposit.
Call: 721-6899

WAYNE
WINTER SPECIAL
1 & 2 bedrooms, from \$335 to \$420. Six month lease. Call Mon-Fri, 9:30am-4:30pm. 728-9699

WAYNE
\$399 MOVES YOU IN
WAYNE FOREST APTS.
FREE HEAT
Separate Dining
Huge Walk-in Closets
Large Storage Area
328-7800
33095 Forest Avenue
Wayne, MI 48184
Free Vacation Get away to Arizona on select units.

WAYNE - 1 & 2 bedroom apts. \$395 & up, includes heat, water, appliances. Nice neighborhood. Section 8 okay. 531-9171 or 722-2979

402 Furnished Apts. For Rent

BIRMINGHAM
Short-Term Lease
Available for 1 month to 1 year, elegantly furnished 1 bedroom unit. Perfect for transferred executive. Call: DENNIS WOLF
Licensed Broker
Halt-Wolf Properties
647-8100

BIRMINGHAM/W. Bloomfield/Troy
BLOOMFIELD LAKES APTS.
Furnished apts. in small, quiet complex. Fully furnished & decorated studio, 1 & 2 bedroom units. Includes dishes, linens, etc. In-unit laundry and washer privileges. No pets please. Rents starting at \$475. Heat & water included. Short term leases for qualified applicants.
681-8309

FARMINGTON - 1 bedroom furnished apt. Washer & dryer. Heat included. Indoor pool \$550/mo. & security. Call evenings 473-8884

ROYAL OAK DOWNTOWN
Studio apartment fully furnished. \$400 per month. In quiet, secured, adjacent to (year) building. (flexible). Storage lockers. You get electric - WE PAY HEAT. No pets. Off-street parking and access to laundry facilities. Minimum income required \$18,000 a year.
258-8200 or 542-9559

SOUTHFIELD - high rise, furnished, 1 bedroom, FREE HEAT, laundry, studio \$500. 557-4800

404 Houses To Rent

N.W. OUTER DR. AREA - 3 houses. All bricks, basements, garages. Clean & quiet neighborhood. Add & Section 8 okay. \$450 & up. 728-2028

FIVE MILE/TELEGRAPH
Nice 2 bedroom, enclosed porch with utility area. \$325 month + security deposit. 681-1732

DETROIT - Evergreen & Warren. Extra clean 3 bedroom, basement, 2 car garage, fenced yard. \$535-5758

FARMINGTON HILLS - 3 bedroom bungalow, large laundry room, garage, \$750/mo. 1st & last + security. Farmington Schools. 738-5185

GRAND RIVER/MIDDLEBEEK - 2 bedroom. Grand River/Middlebeek. Must see! \$600 month + security. 442-0843

FARMINGTON HILLS - available small 2 bedroom home, 13 mile near Orchard Lake. Gas heat, large yard. \$525 per month. 681-8309

ROYAL OAK DOWNTOWN
Studio apartment fully furnished. \$400 per month. In quiet, secured, adjacent to (year) building. (flexible). Storage lockers. You get electric - WE PAY HEAT. No pets. Off-street parking and access to laundry facilities. Minimum income required \$18,000 a year.
258-8200 or 542-9559

SOUTHFIELD - high rise, furnished, 1 bedroom, FREE HEAT, laundry, studio \$500. 557-4800

404 Houses To Rent

ROCHESTER HILLS - 2 bedroom colonial, full basement, 2 1/2 baths, family room, appliances, new decor. Available. Dec 1st. \$1,368 month. 851-4233

ROCHESTER HILLS - Crooks & Auburn 3 bedroom, 1 bath, garage, deck, refrigerator & stove. \$725/mo. 253-1530

ROCHESTER HILLS spacious, spotless, vacant brick 2 + bedroom, 1 1/2 bath, air, carpet, garage. No pets. \$740/mo. security. 537-2384

ROYAL OAK Newly decorated large 3 bedroom colonial, new carpet, 2 car garage, 2 car garage, \$945. 399-1233

ROYAL OAK - Renovated, 3 bedroom ranch, finished basement, stove and refrigerator, fenced yard. \$750. Call: 642-0834

ROYAL OAK Campbell/12 Mile area, 3 bedroom, air, finished basement, 2 car garage, must have cred. check & references. 585-8189

ROYAL OAK Campbell/12 Mile area, 3 bedroom, air, finished basement, 2 car garage, must have cred. check & references. 585-8189

SOUTHFIELD - Beautiful 3 bedroom ranch, 2 1/2 baths, finished garage, new carpet, freshly painted. \$625/mo. + deposit. 399-8444

SOUTHFIELD - New 3 bedroom brick ranch, 2 1/2 bath, family room, appliances, central air, \$1,900. No security. 354-9734, 961-7774

SOUTHFIELD - 3 bedroom ranch with appliances, attached garage, \$750 month. 453-8694

TROY - large 3 bedroom, carpeting, finished basement, fenced, 2 car garage, \$720 month. 464-0062

TROY - 16 MI. & Rochester area. 3 bedroom, 1 1/2 bath, new vinyl windows, 2 car garage, large lot. High heat bills. \$850/mo. 363-6107

TROY - 2 large bedrooms, large lot, washer/dryer, \$750/mo. 393-8899

TROY - large 3 bedroom, carpeting, finished basement, fenced, 2 car garage, \$720 month. 464-0062

TROY - 16 MI. & Rochester area. 3 bedroom, 1 1/2 bath, new vinyl windows, 2 car garage, large lot. High heat bills. \$850/mo. 363-6107

TROY - 2 large bedrooms, large lot, washer/dryer, \$750/mo. 393-8899

TROY - large 3 bedroom, carpeting, finished basement, fenced, 2 car garage, \$720 month. 464-0062

TROY - 16 MI. & Rochester area. 3 bedroom, 1 1/2 bath, new vinyl windows, 2 car garage, large lot. High heat bills. \$850/mo. 363-6107

410 Flats

BIRMINGHAM Around the corner from the Community House, 328 W. Brown, 2 bedroom upper unit, all appliances, neutral decor, central air. Walk to town. \$600 a month. 647-0631
Warren & Southfield expressway. Furnished 1 bedroom upper flat, carpet, color TV, musthills. \$295 plus security. 669-4756

N.W. DETROIT Flat, large 2 bedroom lower, fully updated, \$500 per month, heat included, 1st & last mo. + security required. 348-1111

FARMINGTON DOWNTOWN - un- furnished 1 bedroom, full bath, neighborhood, no pets or smokers, 1 yr. lease, \$450 a month includes utilities. Call: 477-6503

PLYMOUTH - Downtown charming 1 bedroom, appliances, washer/dryer, deck. Suitable for single. No pets. 335-8372

WARREN & EVERGREEN
1 bedroom, 1 bath, 1/2 car, refrigerator, heat & water. \$400 per month. 338-8172

WESTLAND - 2 bedroom, carpeting, appliances. Absolutely No Pets!
Proof of Employment. 459-8268

412 Townhouses

ALBURN HILLS SOUTHFIELD
2 or 3 bedroom, 2 1/2 baths, refrigerator, heat & water. \$400 per month. 338-8172

WESTLAND - 2 bedroom, carpeting, appliances. Absolutely No Pets!
Proof of Employment. 459-8268

420 Rooms For Rent

ROOM for rent by the week for mature working couple. Grand River/ Telegraph. 522-4219

421 Living Quarters To Share

ALL CITIES SINCE 1976
"QUALIFIED"
ROOMMATES
FREE PREVIEW
Share Hobbies
884 S. Adams, Birmingham
642-1620

BEVERLY HILLS - Responsible individual seeking the same to share beautiful 3 bedroom ranch w/3 car garage. Call for details. 549-1774

BIRMINGHAM - Professionals, non smoking female, to share Townhouse with same Great Area! \$375/mo. + utilities. 644-7605
curly deposit. No pets. 538-5188

FARMINGTON - Female to share 3 bedroom home with same. Short term rent. \$250/mo. + utilities & security deposit. 647-8676

FARMINGTON HILLS - Roommate wanted, new house, wooded lot. \$335/month includes utilities. Non-smoker. After 6pm. 476-8762

FEMALE: professional responsible non smoking seeks mate to share Farmington Condo. Clean, washer & dryer. \$275. 1/1 electric. 474-7934
455-7595, ext. 433

FEMALE ROOMMATE - to share 2 bedroom apt. in Westland, quiet living, no drinking, no smoking. \$275/mo. 722-7241
Security deposit. Call after 5pm.

LIVING quarters to rent, \$200 with utilities included. Redford area. Call after 7 PM. 532-6211

MALE 27, STRAIGHT, masters degree student, seeks professional house mate in Livonia. \$365/mo. + utilities. Call David. 421-5653

NON-SMOKER
Wanted to share home in Huntington Woods. 2 car garage. Rent \$350. 844-4195

NON SMOKING male to share Berkeley home. \$325 includes utilities. 548-7434

NOVI
Prefer female smoker, to share my 2 bedroom condo, \$300 month. 477-5962

PLYMOUTH TOWNSHIP - Unique lower level, 1 possibly 2 bedrooms, all utilities, references. \$150 per month. After 6pm. 455-3335

PROFESSIONAL MALE looking for roommates. 2 bedroom, \$275/mo. in Troy. Fully furnished. \$360 per month. Call Steven at 559-3006

PROFESSIONAL ROOMMATE needed to share huge home on 10 acres in prime area of Farmington Hills. Kitchen and laundry privileges. \$300 month plus security. 737-5782

REDFORD - Single working woman to share with same 5 bedroom, 2 bath, fireplace, washer/dryer, all utilities included. \$275. 532-2520

ROOMMATE - Male or female, non-smoker for large home in Bloomfield Hills. \$400 per month includes utilities. 737-5782

ROOMMATE NEEDED, male or female to share my roomy 2 bedroom apt. in Northville, as of Jan. 1. Please call. 313-380-0402

ROOMMATE WANTED to share home in Westland, separate living room, kitchen and laundry privileges. \$300 month plus security. 728-9594

ROYAL OAK - 2 bedroom apartment, female preferred, \$320/month, heat & water included. 435-2875

SOUTHFIELD - Share 4 bedroom home/quality area. Kitchen & laundry. No pets. No smoking. \$235-\$275. Share utilities. 746-9237

TIRE D OF PAYING HIGH RENT? Share Southfield 4 bedroom home, kitchen and laundry privileges. Only \$255 plus utilities. 548-1851

WALLED LAKE - Roomer needed to share condo, male/female. \$260/MO. includes all bills except phone & electricity. Call Dewey 669-6587

WAYNE - Share 2 bedroom apartment, \$200 per month plus 1/2 utilities. Rent December 1st. Ask for Ron. 467-9212

Westland/Livonia - straight male, at least 25 yrs. Share 2 bedroom apt. Private bath, many plus, \$345/mo. plus half utilities, low security deposit. Call Chris. 454-9256

WESTLAND - 2 females to share 4 bedroom house with same. \$250 mo. each. 100% security. All utilities paid except phone. See 699-6739

W. BLOOMFIELD - Roommate wanted for 3 bedroom home with Upper Struts Lake docking & beach privileges. \$325/Mo. 683-0581

W. BLOOMFIELD - professional male seeks responsible male/female to share 2 bedroom condo, starting Dec. 15. \$375/mo. + utilities, washer/dryer. 932-8558

Things That make you go HmMMM ...

Have you ever wondered why so many apartment communities rent the way a month of free rent or more?

HmMMM ...
At
Cedar Lake Apartments
You won't find all the Special Giveaways
Just Great Services
At Great Prices

• 1 & 2 Bedroom Apartments & Townhomes
• 100% Security Deposit!
• We Love Pets

1 Bedrooms Starting at \$324!
2 Bedrooms Starting at \$379!

348-1830
Mon - Fri, 9-6
Sat. 12-4
Located in Northville on E Mile just 2 miles west of I-75

FREE RENT UNTIL 1993!

SPACIOUS 1 BEDROOM/DEN & 2 BEDROOMS

Our luxury apartments feature:
• Attached garage with opener
• Full size washer & dryer
• Mini & vental blinds
• Microwave
• Private entrance
• Utility room for storage
• Newly decorated clubhouse
• Easy access to major freeways

LIMITED TIME ONLY!
Maple between Farmington & Drake

THORNBERY APARTMENTS

A Village Green Community
• Some restrictions apply

WESTLAND
Ford/Wayne Road Area
Spacious 1 & 2 bedroom apartments located close to shopping & expressways. Other amenities include:
• Carpeting
• Dishwasher
• Park-like Setting
• Owner Paid Heat
• Laundry Facilities
• Window Treatments
• New Counter Tops
• Garbage Disposals
• Private Entrances
• Air Conditioning
From \$395 Monthly
SECOND MONTH'S RENT FREE.
WITH 1 YEAR LEASE
COUNTRY VILLAGE APTS
326-3280

Westland Park Apts.
Across from City Park
(between Middlebelt & Merriman)
SPECIAL - LIMITED TIME ONLY
SAVE \$45/mo!
1 bedroom now \$430
2 bedroom, 1 1/2 bath - \$490
\$200 DEPOSIT ALL APTS.
(1 year lease)
HEAT INCLUDED
729-6636

WESTLAND
Spacious 1 & 2 bedroom apartments located close to shopping & expressways. Other amenities include:
• Carpeting
• Park-like Setting
• Owner Paid Heat
• Laundry Facilities
• Window Treatments
• New Counter Tops
• Garbage Disposals
• Private Entrances
• Air Conditioning
From \$395 Monthly
SECOND MONTH'S RENT FREE.
WITH 1 YEAR LEASE
COUNTRY VILLAGE APTS
326-3280

404 Houses To Rent

ADDITION TO ALLEN PARK AND
ALL AREAS
OVER 700 VACANCIES DAILY
RENTAL REFERRAL PROS

356-RENT

23100 TELEGRAPH
Mon.-Fri. 9am-7pm, Sat. 9am-5pm

BERKLEY - 3 bedroom 1 bath bungalow 2 car garage, finished basement, newer kitchen. Possession mid Dec. \$825 per month. 682-0154

BEVERLY HILLS - beautiful home freshly painted, newly sanded hardwood floors, 2 bedrooms, 1 bath, dining room, living room, all appliances including washer & dryer. \$900/mo. Available Dec 15. 642-7590 or 331-0123

BIRMINGHAM - a charming in town 3 bedroom 1 1/2 bath, updated appliances, finished basement, fenced yard, garage. \$1400/mo. 400-0280

BIRMINGHAM - A clean attractive 2 bedroom, 1 bath, den, basement, hand location, fenced yard. Rent \$675. Deposit \$850. 360-2353

BIRMINGHAM - Affordable 2 bedroom ranch with basement, 958 sq. ft. Available. \$795. 437-4002

BIRMINGHAM - 3585-1119 or 391-1969

BIRMINGHAM & ALL CITIES
RENT-A-HOME
HOUSES, APARTMENTS, ETC.

PREVIEW 100% FREE
TENANTS & LANDLORDS
Share Referrals
642-1620
884 S. Adams, Birmingham

BIRMINGHAM - A lovely 2 bedroom ranch with sun porch, basement, deck, oak floors, appliances and pool. \$795. Majesty. 332-6500

BIRMINGHAM - Close to William Beaumont. Beautiful, clean, cozy 3 bedrooms, 1 1/2 bath, finished basement. 2 car garage, new carpet & tile. Includes \$950/month. 363-0329

BIRMINGHAM - downtown 2 bedroom, 1 bath ranch, hardwood floors, 1 car garage, private street with unique view. 245 Valview. \$1250/mo. 597-9724

BIRMINGHAM - Great location, 3 bedroom ranch, finished basement, stove, refrigerator, washer, dryer, garage. \$890. 646-7648

BIRMINGHAM & OTHER SUBURBS
CORPORATE TRANSFERREES
For your relocation needs, call:
D & H PROPERTIES
737-4002

BIRMINGHAM SCHOOLS: Attractive Brick 3 bed ranch, 2 fireplaces, family room, 3 baths, attached garage. New kitchen. \$1200 plus utilities. 628-4976

BIRMINGHAM - 2 bedroom, 2 bath charmer. Fireplace, attached garage. Very near downtown. \$1,050 per month. Even. 258-6776

BIRMINGHAM - 1591 Haynes, N. of Lincoln, E. of Adams. 3 bedroom, 1 1/2 bath, central air, 2 car garage. \$925/MO. 258-6776

BIRMINGHAM - 2 bedroom, 1 bath, full basement, 1 car garage, stove, refrigerator, washer, dryer. Exclusively remodeled interior. No cats. \$750/mo. 642-2665

BIRMINGHAM
2 bedroom, appliances, basement, near town. \$625/month plus utilities & security deposit. 360-2353

BIRMINGHAM - 2 bedroom brick ranch, full basement, newly decorated. \$700/mo. + utilities & security. Available Dec. 20. 647-4654

BIRMINGHAM - 2 bedroom lower, 1 bath, close to town, \$690/mo. 1038 sq. ft. Available immediately. 360-2353

BIRMINGHAM - 2 bedroom brick ranch, full basement, newly decorated. \$700/mo. + utilities & security. Available Dec. 20. 647-4654

BIRMINGHAM - 1591 Haynes, N. of Lincoln, E. of Adams. 3 bedroom, 1 1/2 bath, central air, 2 car garage. \$925/MO. 258-6776

BIRMINGHAM - 2 bedroom, 1 bath, full basement, 1 car garage, stove, refrigerator, washer, dryer. Exclusively remodeled interior. No cats. \$750/mo. 642-2665

BIRMINGHAM
2 bedroom, appliances, basement, near town. \$625/month plus utilities & security deposit. 360-2353

BIRMINGHAM - 2 bedroom brick ranch, full basement, newly decorated. \$700/mo. + utilities & security. Available Dec. 20. 647-4654

BIRMINGHAM - 1591 Haynes, N. of Lincoln, E. of Adams. 3 bedroom, 1 1/2 bath, central air, 2 car garage. \$925/MO. 258-6776

BIRMINGHAM - 2 bedroom, 1 bath, full basement, 1 car garage, stove, refrigerator, washer, dryer. Exclusively remodeled interior. No cats. \$750/mo. 642-2665

BIRMINGHAM
2 bedroom, appliances, basement, near town. \$625/month plus utilities & security deposit. 360-2353

BIRMINGHAM - 2 bedroom brick ranch, full basement, newly decorated. \$700/mo. + utilities & security. Available Dec. 20. 647-4654

BIRMINGHAM - 1591 Haynes, N. of Lincoln, E. of Adams. 3 bedroom, 1 1/2 bath, central air, 2 car garage. \$925/MO. 258-6776

BIRMINGHAM - 2 bedroom, 1 bath, full basement, 1 car garage, stove, refrigerator, washer, dryer. Exclusively remodeled interior. No cats. \$750/mo. 642-2665

BIRMINGHAM
2 bedroom, appliances, basement, near town. \$625/month plus utilities & security deposit. 360-2353

BIRMINGHAM - 2 bedroom brick ranch, full basement, newly decorated. \$700/mo. + utilities & security. Available Dec. 20. 647-4654

BIRMINGHAM - 1591 Haynes, N. of Lincoln, E. of Adams. 3 bedroom, 1 1/2 bath, central air, 2 car garage. \$925/MO. 258-6776

BIRMINGHAM - 2 bedroom, 1 bath, full basement, 1 car garage, stove, refrigerator, washer, dryer. Exclusively remodeled interior. No cats. \$750/mo. 642-2665

BIRMINGHAM
2 bedroom, appliances, basement, near town. \$625/month plus utilities & security deposit. 360-2353

BIRMINGHAM - 2 bedroom brick ranch, full basement, newly decorated. \$700/mo. + utilities & security. Available Dec. 20. 647-4654

BIRMINGHAM - 1591 Haynes, N. of Lincoln, E. of Adams. 3 bedroom, 1 1/2 bath, central air, 2 car garage. \$925/MO. 258-6776

BIRMINGHAM - 2 bedroom, 1 bath, full basement, 1 car garage, stove, refrigerator, washer, dryer. Exclusively remodeled interior. No cats. \$750/mo. 642-2665

BIRMINGHAM
2 bedroom, appliances, basement, near town. \$625/month plus utilities & security deposit. 360-2353

BIRMINGHAM - 2 bedroom brick ranch, full basement, newly decorated. \$700/mo. + utilities & security. Available Dec. 20. 647-4654

BIRMINGHAM - 1591 Haynes, N. of Lincoln, E. of Adams. 3 bedroom, 1 1/2 bath, central air, 2 car garage. \$925/MO. 258-6776

BIRMINGHAM - 2 bedroom, 1 bath, full basement, 1 car garage, stove, refrigerator, washer, dryer. Exclusively remodeled interior. No cats. \$750/mo. 642-2665

BIRMINGHAM
2 bedroom, appliances, basement, near town. \$625/month plus utilities & security deposit. 360-2353

BIRMINGHAM - 2 bedroom brick ranch, full basement, newly decorated. \$700/mo. + utilities & security. Available Dec. 20. 647-4654

BIRMINGHAM - 1591 Haynes, N. of Lincoln, E. of Adams. 3 bedroom, 1 1/2 bath, central air, 2 car garage. \$925/MO. 258-6776

BIRMINGHAM - 2 bedroom, 1 bath, full basement, 1 car garage, stove, refrigerator, washer, dryer. Exclusively remodeled interior. No cats. \$750/mo. 642-2665

BIRMINGHAM
2 bedroom, appliances, basement, near town. \$625/month plus utilities & security deposit. 360-2353

BIRMINGHAM - 2 bedroom brick ranch, full basement, newly decorated. \$700/mo. + utilities & security. Available Dec. 20. 647-4654

BIRMINGHAM - 1591 Haynes, N. of Lincoln, E. of Adams. 3 bedroom, 1 1/2 bath, central air, 2 car garage. \$925/MO. 258-6776

BIRMINGHAM - 2 bedroom, 1 bath, full basement, 1 car garage, stove, refrigerator, washer, dryer. Exclusively remodeled interior. No cats. \$750/mo. 642-2665

BIRMINGHAM
2 bedroom, appliances, basement, near town. \$625/month plus utilities & security deposit. 360-2353

BIRMINGHAM - 2 bedroom brick ranch, full basement, newly decorated. \$700/mo. + utilities & security. Available Dec. 20. 647-4654

BIRMINGHAM - 1591 Haynes, N. of Lincoln, E. of Adams. 3 bedroom, 1 1/2 bath, central air, 2 car garage. \$925/MO. 258-6776

BIRMINGHAM - 2 bedroom, 1 bath, full basement, 1 car garage, stove, refrigerator, washer, dryer. Exclusively remodeled interior. No cats. \$750/mo. 642-2665

BIRMINGHAM
2 bedroom, appliances, basement, near town. \$625/month plus utilities & security deposit. 360-2353

BIRMINGHAM - 2 bedroom brick ranch, full basement, newly decorated. \$700/mo. + utilities & security. Available Dec. 20. 647-4654

BIRMINGHAM - 1591 Haynes, N. of Lincoln, E. of Adams. 3 bedroom, 1 1/2 bath, central air, 2 car garage. \$925/MO. 258-6776

BIRMINGHAM - 2 bedroom, 1 bath, full basement, 1 car garage, stove, refrigerator, washer, dryer. Exclusively remodeled interior. No cats. \$750/mo. 642-2665

BIRMINGHAM
2 bedroom, appliances, basement, near town. \$625/month plus utilities & security deposit. 360-2353

BIRMINGHAM - 2 bedroom brick ranch, full basement, newly decorated. \$700/mo. + utilities & security. Available Dec. 20. 647-4654

BIRMINGHAM - 1591 Haynes, N. of Lincoln, E. of Adams. 3 bedroom, 1 1/2 bath, central air, 2 car garage. \$925/MO. 258-6776

BIRMINGHAM - 2 bedroom, 1 bath, full basement, 1 car garage, stove, refrigerator, washer, dryer. Exclusively remodeled interior. No cats. \$750/mo. 642-2665

BIRMINGHAM
2 bedroom, appliances, basement, near town. \$625/month plus utilities & security deposit. 360-2353

BIRMINGHAM - 2 bedroom brick ranch, full basement, newly decorated. \$700/mo. + utilities & security. Available Dec. 20. 647-4654

BIRMINGHAM - 1591 Haynes, N. of Lincoln, E. of Adams. 3 bedroom, 1 1/2 bath, central air, 2 car garage. \$925/MO. 258-6776

BIRMINGHAM - 2 bedroom, 1 bath, full basement, 1 car garage, stove, refrigerator, washer, dryer. Exclusively remodeled interior. No cats. \$750/mo. 642-2665

BIRMINGHAM
2 bedroom, appliances, basement, near town. \$625/month plus utilities & security deposit. 360-2353

BIRMINGHAM - 2 bedroom brick ranch, full basement, newly decorated. \$700/mo. + utilities & security. Available Dec. 20. 647-4654

BIRMINGHAM - 1591 Haynes, N. of Lincoln, E. of Adams. 3 bedroom, 1 1/2 bath, central air, 2 car garage. \$925/MO. 258-6776

BIRMINGHAM - 2 bedroom, 1 bath, full basement, 1 car garage, stove, refrigerator, washer, dryer. Exclusively remodeled interior. No cats. \$750/mo. 642-2665

BIRMINGHAM
2 bedroom, appliances, basement, near town. \$625/month plus utilities & security deposit. 360-2353

BIRMINGHAM - 2 bedroom brick ranch, full basement, newly decorated. \$700/mo. + utilities & security. Available Dec. 20. 647-4654

BIRMINGHAM - 1591 Haynes, N. of Lincoln, E. of Adams. 3 bedroom, 1 1/2 bath, central air, 2 car garage. \$925/MO. 258-6776

BIRMINGHAM - 2 bedroom, 1 bath, full basement, 1 car garage, stove, refrigerator, washer, dryer. Exclusively remodeled interior. No cats. \$750/mo. 642-2665

BIRMINGHAM
2 bedroom, appliances, basement, near town. \$625/month plus utilities & security deposit. 360-2353

BIRMINGHAM - 2 bedroom brick ranch, full basement, newly decorated. \$700/mo. + utilities & security. Available Dec. 20. 647-4654

BIRMINGHAM - 1591 Haynes, N. of Lincoln, E. of Adams. 3 bedroom, 1 1/2 bath, central air, 2 car garage. \$925/MO. 258-6776

BIRMINGHAM - 2 bedroom, 1 bath, full basement, 1 car garage, stove, refrigerator, washer, dryer. Exclusively remodeled interior. No cats. \$750/mo. 642-2665

BIRMINGHAM
2 bedroom, appliances, basement, near town. \$625/month plus utilities & security deposit. 360-2353

BIRMINGHAM - 2 bedroom brick ranch, full basement, newly decorated. \$700/mo. + utilities & security. Available Dec. 20. 647-4654

BIRMINGHAM - 1591 Haynes, N. of Lincoln, E. of Adams. 3 bedroom, 1 1/2 bath, central air, 2 car garage. \$925/MO. 258-6776

BIRMINGHAM - 2 bedroom, 1 bath, full basement, 1 car garage, stove, refrigerator, washer, dryer. Exclusively remodeled interior. No cats. \$750/mo. 642-2665

BIRMINGHAM
2 bedroom, appliances, basement, near town. \$625/month plus utilities & security deposit. 360-2353

BIRMINGHAM - 2 bedroom brick ranch, full basement, newly decorated. \$700/mo. + utilities & security. Available Dec. 20. 647-4654

BIRMINGHAM - 1591 Haynes, N. of Lincoln, E. of Adams. 3 bedroom, 1 1/2 bath, central air, 2 car garage. \$925/MO. 258-6776

BIRMINGHAM - 2 bedroom, 1 bath, full basement, 1 car garage, stove, refrigerator, washer, dryer. Exclusively remodeled interior. No cats. \$750/mo. 642-2665

BIRMINGHAM
2 bedroom, appliances, basement, near town. \$625/month plus utilities & security deposit. 360-2353

BIRMINGHAM - 2 bedroom brick ranch, full basement, newly decorated. \$700/mo. + utilities & security. Available Dec. 20. 647-4654

BIRMINGHAM - 1591 Haynes, N. of Lincoln, E. of Adams. 3 bedroom, 1 1/2 bath, central air, 2 car garage. \$925/MO. 258-6776

BIRMINGHAM - 2 bedroom, 1 bath, full basement, 1 car garage, stove, refrigerator, washer, dryer. Exclusively remodeled interior. No cats. \$750/mo. 642-2665

BIRMINGHAM
2 bedroom, appliances, basement, near town. \$625/month plus utilities & security deposit. 360-2353

BIRMINGHAM - 2 bedroom brick ranch, full basement, newly decorated. \$700/mo. + utilities & security. Available Dec. 20. 647-4654

BIRMINGHAM - 1591 Haynes, N. of Lincoln, E. of Adams. 3 bedroom, 1 1/2 bath, central air, 2 car garage. \$925/MO. 258-6776

BIRMINGHAM - 2 bedroom, 1 bath, full basement, 1 car garage, stove, refrigerator, washer, dryer. Exclusively remodeled interior. No cats. \$750/mo. 642-2665

BIRMINGHAM
2 bedroom, appliances, basement, near town. \$625/month plus utilities & security deposit. 360-2353

BIRMINGHAM - 2 bedroom brick ranch, full basement, newly decorated. \$700/mo. + utilities & security. Available Dec. 20. 647-4654

BIRMINGHAM - 1591 Haynes, N. of Lincoln, E. of Adams. 3 bedroom, 1 1/2 bath, central air, 2 car garage. \$925/MO. 258-6776

BIRMINGHAM - 2 bedroom, 1 bath, full basement, 1 car garage, stove, refrigerator, washer, dryer. Exclusively remodeled interior. No cats. \$750/mo. 642-2665

BIRMINGHAM
2 bedroom, appliances, basement, near town. \$625/month plus utilities & security deposit. 360-2353

BIRMINGHAM - 2 bedroom brick ranch, full basement, newly decorated. \$700/mo. + utilities & security. Available Dec. 20. 647-4654

BIRMINGHAM - 1591 Haynes, N. of Lincoln, E. of Adams. 3 bedroom, 1 1/2 bath, central air, 2 car garage. \$925/MO. 258-6776

BIRMINGHAM - 2 bedroom, 1 bath, full basement, 1 car garage, stove, refrigerator, washer, dryer. Exclusively remodeled interior. No cats. \$750/mo. 642-2665

BIRMINGHAM
2 bedroom, appliances, basement, near town. \$

EMPLOYMENT

500 Help Wanted

A CAREER IN REAL ESTATE SALES WITH US IS A "REAL JOB" Our programs and support systems are so effective, we guarantee you a minimum annual income of \$25,000 with unlimited potential.

DON'T GAMBLE WITH YOUR FUTURE. CALL ME TODAY!
INDIRA OR BARRY, 477-1111
REAL ESTATE ONE, INC.
Farmington-Farmington Hills

A CAREER SHOULD BE BY DESIGN... NOT BY DEFAULT! That's why Real Estate One offers career choices for the self-directed, ambitious individual and then supports those choices through intensive training, staff assistance, high quality education programs, and innovative marketing tools.

Ask about our exciting income program. Call:

Lisa Dumsa
356-7111
REAL ESTATE ONE, INC.

ACCEPTING APPLICATIONS for Loss Control Agents. Experience preferred. Able to work weekends. Call for an appointment: 728-8400

ACCEPTING APPLICATIONS For part time office cleaning. Late evening hours. Farmington area. Mile & Grand River. 759-8505

ACCEPTING APPLICATIONS MANAGERS & FULL & PART TIME HELP For del. inside of office building. Mon-Fri. No weekends or evenings. Southfield & Troy area. Call between 2-5pm. 64-0751

ACCOUNTING CLERK to work part time. Prepare reports and checks. Computerized accounting experience. Lotus, Word-Perfect 5.1, 1-2 years related experience and/or education strongly preferred. Southfield Town Center location. Send resume to: Box 694, JTPA 354-9167

AIRCRAFT GROUND CREW Trainers needed. Handle passengers and mechanics jobs open. High School grads to 34. Call: 1-800-922-1702

A LARGE automotive supplier has an immediate opening for a Human Resources Clerk. Requires strong typing skills, working knowledge of WordPerfect 5.0 & Lotus 1-2-3. Prior human resources experience a plus. We offer a competitive salary and benefit package. Please submit resume to: 704 box, Observer & Eccentric Newspapers, 36251 Schoolcraft Rd., Livonia MI 48150

An Equal Opportunity Employer

ALARM INSTALLER - Expanding west side company. Must be able to install electronic systems and wire devices. Audio and phone experience helpful. Must be team player. Good pay and benefits. 442-0501

MACHINE OPERATORS/ASSEMBLERS TESTERS/SOLDERERS

Progressive electronics company is seeking enthusiastic individuals for the following positions:

- Machine Operators
- Manual Assemblers
- Testers
- Solderers (Experience preferred)

We have afternoon, day and night shift positions available. Excellent benefit package including educational reimbursement and opportunity for advancement. Please apply in person between 9 am-5 pm, Mon.-Fri. at:

Jabil Circuits, Inc.
32275 Mally Rd.
Madison Hts., MI
Mally Rd. is E. of Stephenson Hwy., N. of Whitcomb (13 1/2 Mile)

JABIL CIRCUIT, Inc.

For Additional Information Call: 589-3606
Relocating to Auburn Hills Dec. 1992
Equal Opportunity Employer

COMPUSA THE COMPUTER SUPERSTORE

has immediate opportunities available in its Madison Heights superstore for the following positions:

- Retail Cashiers
- Retail Salespeople
- Stockers
- Warehouse Assistants
- Retail Administrators

Microcomputer hardware and software knowledge a plus. We offer competitive pay and benefits in a non-smoking and drug-free work environment. Send your resume or apply in person at:

CompUSA, Inc.
31601 John R. Road
Madison Heights, MI 48071

Establish a career with the nation's largest department store.

A position at JCPenney may just be the beginning of an exciting career. JCPenney, Westland is now accepting applications for full-time people in the following departments:

- Alterations

Selling Specialists for:

- Furniture
- Window Treatments

1-2 years experience preferred. Benefits include merchandise discount, medical/dental insurance, paid vacations/holidays, sick pay, savings and profit sharing plan.

Apply in person at JCPenney, Westland personnel office, Monday thru Friday 10 to 5.

An equal opportunity employer, M/F/V/H

JCPenney

500 Help Wanted

ACCOUNTANT For CPA firm, located in W. Bloomfield. Minimum 2 yrs recent Public Accounting experience required. People skills a must. FOR APPOINTMENT, 737-8945

ACCOUNTANT - Local firm seeks CPA candidate for staff position. Audit experience necessary - fiscal year opportunity. Reply to: Drawer 5520, Plymouth, MI, 48170

ACT NOW EARN CHRISTMAS CASH
25 Customer service Reps needed beginning Dec. 1 till Christmas in Troy.
Call Today if you type 40 wpm on a computer & have a pleasant phone manner. 464-7220

TODAYS TEMPORARY 589-7144
An Equal Opportunity Employer

AGENCY EXPANDING Needs qualified elderly care workers. Some childcare positions still available. Call anytime. Ask for Cindy. 476-5912

All You Can Handle
Overload of Work
Due to our busy season we need help in all areas of our business. \$300 weekly average. Call Cindy. 299-8981

ALTERATIONS
Looking for a person with experience to work part time doing dry cleaning. Apply 8am-4pm at: Pro-Clean, 19145 Telegraph/7 Mile.

APARTMENT MANAGERS
For beautiful 160 unit complex in NW Detroit. Excellent wages and benefits. Send resume to: P.O. Box 543, Lathrup Village, MI, 48025.

APPLIANCE SERVICE TECHNICIAN Experience & mechanical ability required. Own tools. Honest reputation. Medical & dental benefits provided. Send resume to: Bill & Rod's Appliance, 15210 Middlebelt, Livonia, MI 48154

ASSEMBLY LIGHT Choice of three shifts \$4.25 plus overtime. Livonia and Novi. Call Lucy at 473-2935
Uniforce Temporary Service

APPOINTMENT SETTERS Part time. Day/Even. No Sales. Experience preferred. \$4.25 pay plus bonuses. Wayne County area. Will train. Call Mon-Tues for interview. 981-6500

ASSEMBLER PROGRAMMER Fast growing company in Plymouth, MI. Seeking application programmer. Must know Assembler, DOS/VSE Power PC. Send resume with salary requirements and cover letter to: P.O. Box 252, Plymouth, MI 48170.

ASSISTANT SITE DIRECTORS For litch-key program. Farmington-Farmington Hills school setting. 25-35 hours per week. Excellent work environment & opportunity for other responsibilities. Apply in person with resume to: 12 Mile & Farmington Rd.

GOODYEAR STORE Needs general service tech to mount tires & change oil \$5.50/hr. to start.

MARCH HIRE
Ask for Pat
Farmington 33014 Grand River
Ask for Mark
Southfield 28481 Telegraph

AUTOMOTIVE ALIGNMENT TECHNICIAN Wanted to perform alignments & suspension work. Benefits, holidays. Full time. Apply in person:
March Tire Company
28481 Telegraph & Garden City
Southfield, MI 48034

AUTO DETAIL/RECONDITIONING Forman & Technicians
Must be experienced in high speed buffing or interior shampooing. High Detail Centers. 1-800-773-9500

500 Help Wanted

SMILING FACES MAKING \$55555555
If you have an outgoing personality along with an excellent telephone voice WE NEED YOU! MCI needs appointment setters for our Farmington Office. For high hourly pay, with excellent commissions working evenings, call Mrs. Rush for personal interviews at: 464-7220

APPLIANCE TV Repair Person to assist on pick-up, delivery & repair. Also, Appliance Parts Counter Person, experience necessary. 559-2900

APPLICATIONS for full & part Clerks. Afternoons & evenings, some weekends. Minnesota Fabric, MI & Newburgh. 464-7220

SPORTS MINDED

Management career with future. 18 immediate openings. No experience necessary, must be enthusiastic, ambitious & worth \$400/wk. plus benefits to start.
CARLISA - 416-0810

AT ADIA WE'RE BUSY!!

Want to know what you have to do to get energetic people to do light packaging work in the Westland area. Days & afternoons shifts available. \$4.90 per hour starting salary. Monthly increases. Temporary to permanent positions. Call now for an appointment.

ADIA PERSONNEL SERVICES
722-9060 or 382-2342

ATTENTION!
If you enjoy:
• Dealing with people?
• Working on your own 80% of the time?
• A quick paced day, starting at 4:30am?
Then we may have the job for you. Douglas Foods has positions available as short order cooks on our mobile routes that operate Mon-Fri. Our current cooks earn \$275-\$350 per week plus benefits. No experience is necessary we ask only for an outgoing personality & we will teach you the rest. Apply 9am-4pm, at 32416 Industrial Rd., Garden City, MI 48135. 427-5300

PERSON TO WORK on used car lot. Run errands, small repairs, auto body repair experience helpful.
TYME AUTO 455-5566

GOODYEAR STORE Needs general service tech to mount tires & change oil \$5.50/hr. to start.

MARCH HIRE
Ask for Pat
Farmington 33014 Grand River
Ask for Mark
Southfield 28481 Telegraph

AUTOMOTIVE ALIGNMENT TECHNICIAN Wanted to perform alignments & suspension work. Benefits, holidays. Full time. Apply in person:
March Tire Company
28481 Telegraph & Garden City
Southfield, MI 48034

AUTO DETAIL/RECONDITIONING Forman & Technicians
Must be experienced in high speed buffing or interior shampooing. High Detail Centers. 1-800-773-9500

STRAWBERRY HILLS FRUIT MARKET IMMEDIATE OPENINGS

\$6.00 PER HR.
For full time Cashiers
Deil Workers

Additional and part time positions available. No experience necessary.

Apply at: 32906 Middlebelt Rd. at 14 Mile, Farmington Hills
Apply Mon.-Fri. 10 am-2 pm

APPLY NOW 40 WORKERS NEEDED

Hiring dependable, temporary personnel to work in the Western Suburbs. Long term day shift available for these Blue Jean Jobs. Reliable transportation required.

- Packers
- Wire Harness Assembly
- Experienced Telemarketers

Don't miss this opportunity. No experience necessary. Bring two pieces of ID.

General Management Services
14700 Farmington Rd., Suite 104
Livonia, MI 48154
427-7660
Equal Opportunity Employer

TRANSPORTATION MANAGEMENT TRAINEE (Local Opportunities)

One of the nation's top ten LTL trucking companies has an opening in your area for a Management Trainee. We are looking for college graduates with business or transportation backgrounds interested in the fast pace and challenge of transportation. To the right candidate, we offer:

- Excellent compensation and benefits
- Promotional opportunities
- Extensive training and responsibility

If you feel you have the drive to succeed in transportation and are looking for a long-term career, send your resume to: V.P. of Human Resources, P.O. Box 1247, Warren, MI 48090-1247. Equal Opportunity Employer.

500 Help Wanted

ASSISTANT MANAGER TRAINEE
BOB HAD A JOB
Bob got promoted. Who wants Bob's job? Advance quickly to \$375/wk while in training. Call Holly 847-0710

ATTENTION ROCHESTER!
Looking for extra holiday money? Recruiting now for 30 immediate openings located in Rochester area for expanding plastic injection molding facility.
• MACHINERY OPERATORS •
A few good reasons to talk to us:
• Start now and have extra cash for the holidays.
• \$4.75/hr - \$4.90/hr to start.
• Raise after 90 days.
• Opportunities for growth, benefits, advancement and more.
Call Monday November 23rd between 9am and 4pm for an appointment at: (313) 466-5730
No fee.
RTSI
An Equal Opportunity Employer

BANK TELLERS
Huntington Banks of Michigan is now accepting applications for part time bank tellers. Must be available for 4 weeks of full time training. Next training class beginning in January 1993. Qualified and applicants will have a minimum of 6 months cash handling experience and customer service skills. Various branch locations available. Interested applicants should apply in person between the hours of 8:00AM and Noon at 801 W. Big Beaver, Suite 101, Troy, MI
An Equal Opportunity Employer

SUBSTITUTE TEACHERS NEEDED
Substitute teachers for the school district of the City of Pontiac. Bachelor's degree and teaching certificate desired. No experience necessary. Will consider if one has 120 semester hours & 6 hours of professional education.

Applications are being accepted in the personnel office at 350 E. Wide Track Dr., Pontiac, from 9am-3pm, between 9am and 4pm for an appointment at: (313) 466-5730

AUTO DETAILER
Must be experienced. Commission or hourly. Redford. Call: 937-2620 937-CARS

AUTO GLASS INSTALLERS
Start immediately. Experienced only need apply. Excellent wages & fringe benefits. Call 960-0600

AUTOMATIC SCREW MACHINE
Davenport operator
Must be able to set-up
and grind tooling.
Livonia 422-1323

AUTOMATIC SCREW MACHINE
Brown & Sharpe, set up & operate, minimum 5 yrs. set up experience, benefits. Ask for Bob, 427-3132

AUTO MECHANIC
for busy Firestone Store. Good pay. Must be certified. Please call Ron. 453-3900

AUTO MECHANIC - Experienced drivability mechanic. Pay rate open depending on experience, availability & qualifications. Livonia, 953-2550

AUTO MECHANIC NEEDED
For West Bloomfield Midas. Must be certified in brakes and front end with possible management position available. Call 826-5131

AUTOMOTIVE TECHNICIAN - Must be certified. Drivability and tune-up. Good pay and benefits. Ask for Don. 455-6851

AUTO TECHNICIAN WANTED
Drive-ability experience. Good opportunities. Call 425-0310

AVAILABLE POSITIONS - At Presbyterial Village. Maintenance, release cook/supervisor, service desk. Apply in person to: 32001 Cherry Hill, Westland.

CAD/CAM OPERATOR
Day or night shift position available immediately. Must have 2 years experience with Gerber system. Excellent benefits & competitive wages. Send resume or apply at: Greenfield Dr. 8301 Rondra Drive, Canton, MI 48187

CANVASSERS WANTED
Need 7-10 people who work well with others. \$200 - per week. Apply in person: 5812 12 Mile Road, Warren, southwest corner of 12 Mile and Mound Rds.

CASHIER
Full time, 11pm-7am. Medical/dental +. Secured. Or other part time. Apply Mon.-Fri. Mobil Mart, Grand River & Drake (Farmington).

CASHIERS & DRIVEWAY ATTENDANTS
Immediate opening for full-service Shell Auto Care. Flexible hours, \$5 to start with advancement & benefits. Farmington Hills. 553-2622

CASHIERS For immediate employment. Full/part time. Will train. Apply at: Amoco 2481 S. Telegraph & Square Lake or 30835 Greenfield & 13 Mile.

CASHIERS for self serve gas station/convenience store. Full and part time, afternoons and midnights. Good job for retirees. Apply in person only. Marathon Gas Station, 31425 Ann Arbor Trail at Merriman.

CHEMICAL TECHNICIAN
Environmental lab needs full time tech w/1 year college chemistry. Hours: 10:00 am - 6:30 pm after training. Rate \$6-\$7/hr.
Personnel Director
Code DOP/11-19
Midwest Analytical Services, Inc.
2727 Second Avenue
Detroit, MI, 48201

CHILD CARE
Care givers program Director and Secretary needed for Latchkey program in Detroit. Must have experience. Call Mrs. Teasley at: 270-0635

CHRISTMAS HELP
Seasonal help now. Some may continue in 1993. Start now. \$8.50 pay. college students welcome. 442-9270

500 Help Wanted

AUTO PORTER
Needed at waste site dealer. Good driving record a must. Apply in person at Town & Country Dodge, 31015 Grand River, Farmington Hills. 474-6750

AUTO PREP MANAGER
Take charge type with the ability to coordinate scheduling of new car deliveries and supervise porters and wash crew. Good people skills a must. Auto experience helpful but not necessary. Apply in person: Bill Brown Ford, ask for Mike Schriber, 32222 Plymouth Rd.

BALLY'S VICTANNY
No us accepting resumes for our Sales Training program. If you are an energetic self-motivated professional sales person, this could be the career opportunity for you. Please mail or drop off your resume at: 16000 Northland, MI, 48075. Interviews will begin first week of Dec.

BANK TELLERS
Huntington Banks of Michigan is now accepting applications for part time bank tellers. Must be available for 4 weeks of full time training. Next training class beginning in January 1993. Qualified and applicants will have a minimum of 6 months cash handling experience and customer service skills. Various branch locations available. Interested applicants should apply in person between the hours of 8:00AM and Noon at 801 W. Big Beaver, Suite 101, Troy, MI
An Equal Opportunity Employer

SUBSTITUTE TEACHERS NEEDED
Substitute teachers for the school district of the City of Pontiac. Bachelor's degree and teaching certificate desired. No experience necessary. Will consider if one has 120 semester hours & 6 hours of professional education.

Applications are being accepted in the personnel office at 350 E. Wide Track Dr., Pontiac, from 9am-3pm, between 9am and 4pm for an appointment at: (313) 466-5730

AUTO DETAILER
Must be experienced. Commission or hourly. Redford. Call: 937-2620 937-CARS

AUTO GLASS INSTALLERS
Start immediately. Experienced only need apply. Excellent wages & fringe benefits. Call 960-0600

AUTOMATIC SCREW MACHINE
Davenport operator
Must be able to set-up
and grind tooling.
Livonia 422-1323

AUTOMATIC SCREW MACHINE
Brown & Sharpe, set up & operate, minimum 5 yrs. set up experience, benefits. Ask for Bob, 427-3132

AUTO MECHANIC
for busy Firestone Store. Good pay. Must be certified. Please call Ron. 453-3900

AUTO MECHANIC - Experienced drivability mechanic. Pay rate open depending on experience, availability & qualifications. Livonia, 953-2550

AUTO MECHANIC NEEDED
For West Bloomfield Midas. Must be certified in brakes and front end with possible management position available. Call 826-5131

AUTOMOTIVE TECHNICIAN - Must be certified. Drivability and tune-up. Good pay and benefits. Ask for Don. 455-6851

AUTO TECHNICIAN WANTED
Drive-ability experience. Good opportunities. Call 425-0310

AVAILABLE POSITIONS - At Presbyterial Village. Maintenance, release cook/supervisor, service desk. Apply in person to: 32001 Cherry Hill, Westland.

CAD/CAM OPERATOR
Day or night shift position available immediately. Must have 2 years experience with Gerber system. Excellent benefits & competitive wages. Send resume or apply at: Greenfield Dr. 8301 Rondra Drive, Canton, MI 48187

CANVASSERS WANTED
Need 7-10 people who work well with others. \$200 - per week. Apply in person: 5812 12 Mile Road, Warren, southwest corner of 12 Mile and Mound Rds.

CASHIER
Full time, 11pm-7am. Medical/dental +. Secured. Or other part time. Apply Mon.-Fri. Mobil Mart, Grand River & Drake (Farmington).

CASHIERS & DRIVEWAY ATTENDANTS
Immediate opening for full-service Shell Auto Care. Flexible hours, \$5 to start with advancement & benefits. Farmington Hills. 553-2622

CASHIERS For immediate employment. Full/part time. Will train. Apply at: Amoco 2481 S. Telegraph & Square Lake or 30835 Greenfield & 13 Mile.

CASHIERS for self serve gas station/convenience store. Full and part time, afternoons and midnights. Good job for retirees. Apply in person only. Marathon Gas Station, 31425 Ann Arbor Trail at Merriman.

CHEMICAL TECHNICIAN
Environmental lab needs full time tech w/1 year college chemistry. Hours: 10:00 am - 6:30 pm after training. Rate \$6-\$7/hr.
Personnel Director
Code DOP/11-19
Midwest Analytical Services, Inc.
2727 Second Avenue
Detroit, MI, 48201

CHILD CARE
Care givers program Director and Secretary needed for Latchkey program in Detroit. Must have experience. Call Mrs. Teasley at: 270-0635

CHRISTMAS HELP
Seasonal help now. Some may continue in 1993. Start now. \$8.50 pay. college students welcome. 442-9270

500 Help Wanted

CARPENTERS WANTED
Southern Oakland County. Call after 6pm. 517-468-3540

CARPENTERS - wanted, steady work, immediate openings, experience preferred. 348-2514

CARPET CLEANERS WANTED, qualified, must have transportation for commercial & residential carpet cleaning service. 425-4813

PART TIME POSITIONS at Natural Food Super Market in Livonia. Food/clean up or Cashier. 477-7440

CASHIER - Full or Part Time. Steady. Mature persons. Will train. Redford's of Farmington. 476-7766

CASHIERS

• Full or part-time positions available, perfect for students. \$5/hr. + bonuses.
Blue Cross/Blue Shield available.
Apply: Orchard 14 Car Wash, 30980 Orchard Lake (S. of 14 Mile), Farmington Hills.

CASHIERS/STOCK - Now accepting applications for part & full-time. Apply at Concord Drugs, 37290 Five Mile Rd., Livonia. 464-6200 EOE

CASHIER/STOCK
Perry Drug Stores, Inc. is seeking Cashier/Stock persons for the P.M. Shift. Apply in person at: 5736 N. Middlebelt, Garden City, MI

CASHIERS WANTED
Full time. Pleasant room for advancement. Benefits after 1 year include: medical & paid vacations. Please apply: TOTAL PETROLEUM, Ecorse/Monroe, 941 Telegraph, Southfield/Allen, Goddard/Pardee, Northline/Reed, Ford/Cleveland, Div. Livonia, Dearborn, Michigan & Bittle/Ford.

BODY SHOP RECEPTIONIST
for high volume auto dealer. Experience helpful. Must be well organized and people oriented. We offer BC/BS, life insurance, disability insurance, 401K and paid vacations. Call for interview. Redford 48239. Ask for Don Mc Donald 255-3130. EXT. 270

BRIDGEPORT & LATHE HAND needed immediately. Experience preferred. 420-0210

CABINET MAKER - Small custom shop specializing in contemporary laminated cabinets and furniture. Needs experience, dependable Builders & Installer. Knowledge of drafting and design a plus. 427-1630

CAD/CAM OPERATOR
Day or night shift position available immediately. Must have 2 years experience with Gerber system. Excellent benefits & competitive wages. Send resume or apply at: Greenfield Dr. 8301 Rondra Drive, Canton, MI 48187

CANVASSERS WANTED
Need 7-10 people who work well with others. \$200 - per week. Apply in person: 5812 12 Mile Road, Warren, southwest corner of 12 Mile and Mound Rds.

CASHIER
Full time, 11pm-7am. Medical/dental +. Secured. Or other part time. Apply Mon.-Fri. Mobil Mart, Grand River & Drake (Farmington).

CASHIERS & DRIVEWAY ATTENDANTS
Immediate opening for full-service Shell Auto Care. Flexible hours, \$5 to start with advancement & benefits. Farmington Hills. 553-2622

CASHIERS For immediate employment. Full/part time. Will train. Apply at: Amoco 2481 S. Telegraph & Square Lake or 30835 Greenfield & 13 Mile.

CASHIERS for self serve gas station/convenience store. Full and part time, afternoons and midnights. Good job for retirees. Apply in person only. Marathon Gas Station, 31425 Ann Arbor Trail at Merriman.

CHEMICAL TECHNICIAN
Environmental lab needs full time tech w/1 year college chemistry. Hours: 10:00 am - 6:30 pm after training. Rate \$6-\$7/hr.
Personnel Director
Code DOP/11-19
Midwest Analytical Services, Inc.
2727 Second Avenue
Detroit, MI, 48201

500 Help Wanted

DRIVER
Due to rapid growth J Wholesale seeks full time drivers with a CDL. A license to deliver to residents. Approximately 18 stops/day. May involve one night/week away from home. Requires excellent driving record & 1-2 years experience driving tractor trailer. Recent truck driving graduates are encouraged to apply. If interested please apply in person for an immediate interview at:
7070 E. 10 Mile Rd.
Center Line (W. of Van Dyke)
DRIVERS/Dispatchers/Mechanics
For growing cab company.
Call for application.
591-2325

DRIVERS
Tractor-Trailer/Local Route
\$500-\$600/week
Medical, Dental & Retirement Plans
Home every night
Must have quality work & driving record. Drivers must have COL-A.
1-800-334-2875

DRIVER - with van needed for package & freight delivery. Late model 1 ton cargo van needed. Paid percentage. Call. Call now. 459-4215

DRY CLEANERS
Need an energetic person to work the counter. Pleasant working conditions. Mon. thru Fri. 3 to 7:30pm. Come in or call. Touch of Class Cleaners, 1150 Ave. Arthur Rd., Plymouth. 453-7474

DRYWALL, Acoustical Ceiling Installers & Laborer. Experienced preferred, but not required. Apply in person 8-5pm, Mon-Fri. at 539 N. Wayne Rd., Westland. An Equal Opportunity Employer

DYE ASSEMBLY - steady work for self motivated person experienced in assembly & try out of metal forming/drawing dies. Must be able to set up and operate tool room machinery. Apply in person at 101 Industrial Dr., Plymouth. 453-1519

PLC & CNC ENGINEER - solid in PLC & CNC (Evert). Send resume & 3 references to Manpower Technical, 457 Pearl St., Cadillac, MI 49601. (616) 775-1622

ENERGETIC, CARING People to work with developmentally disabled adults in a group home in the Lake Orion area. Must be 18 years old, have high school diploma or GED and valid Michigan drivers license to apply. Afternoon, midnight & weekend shifts available. 313-693-2784

QUALITY ENGINEER
Position available to individual with 2 yrs experience in part layout, blueprint reading, geometric tolerance & SPC. Excellent benefits & competitive wages. If you qualify, please send resume to: Greenfield Drive, #187, 8301 Ronda Drive, Canton, MI 48107. 313-693-2784

FIELD WIRING
3 yrs minimum. Field experience a must. Read Schematics. Bend conduit, wire controls panels. Ask for William Reed. 442-7048

PANEL WIRING
Flexible part-time hours. Wire control panels. Ask for Larry Rosow. 453-4500

QUANTUM CONTROLS INC.
3999 Schoolcraft
Livonia, MI 48150
An Equal Opportunity Employer

500 Help Wanted

ENGINEER/DRAFTSMAN
Precision Hills manufacturer of precision steel parts has opening for person experienced with hardened & precision ground steel. Recent experience helpful. Benefits, paid vacations & holidays. Call Mon. thru Thurs. 473-9305

ENGINEER/TECHNICIAN
Position available for an individual knowledgeable in plastic mold making & general program management. Excellent benefits & wages. Please send resume or apply in person to Greenfield Dr. & Mtg., 8301 Ronda Dr., Canton, MI 48107. 313-693-2784

ESTIMATE LIQUIDATORS
Looking for versatile individual with Strong MSAE/ATI times heavy furniture & boxes. Must have drivers license. Call. 535-6670

ESTIMATOR for established fire repair contractor. Must have at least 5 years experience with good work habits. Please send resume with salary requirements to box 636 Observer & Eccentric Newspapers, 36251 Schoolcraft Rd., Livonia MI 48150

EXECUTIVE ASSISTANT
For insurance agency. Commercial property & casualty experience required. Excellent salary & benefits. Send resume to: PO Box 1300, Birmingham, MI 48012-1300

EXERCISE INSTRUCTOR WANTED
At Laurel Park. Career opportunity. 452-4060

MAINTENANCE PERSON - 3-5 years experience in apts. Knowledgeable in heating, plumbing, electrical, etc. Must be able to handle other duties. Must live on-site. Own tools. Send resume to: P. Envidge, 23870 Middlebelt, Farmington Hills, MI 48336.

ENTRY LEVEL FLORAL DESIGNER
General shop help. 262-1204

FLOOR PERSON - Experienced in stripping, sealing, waxing and spray buffing resilient tile, marble & stone floors. 453-4545

FLORAL DESIGNER
Experienced for upscale Birmingham florist. Part time/full time. Call Cheryl at 647-0455

FLORAL SHOP requires person for entry level position, various duties. Experience helpful, not necessary. W. Bloomfield area, shop. 669-5970

FOREMAN-NIGHT SHIFT
Single and multi-spindle screw machine dept. Experienced in repair, set-up and tool grinding. Phone 931-2000

FACTORY - \$7-\$15/HR
Will train JNI

500 Help Wanted

FIREFIGHTER
The Charter Township of West Bloomfield is accepting applications for the position of Firefighter. Applicants must be a U.S. Citizen, over 18 years of age, a high school graduate or equivalent, be able to read, write and speak the English language clearly and distinctly. Have a valid driver's license, a good driving record and not have been convicted of any crime involving moral turpitude. Applicants must also be in a physical, emotional and mental condition determined sufficient to perform the essential functions of the position. Final determination is based upon ability to pass written and physical performance examinations, psychological and oral interviews, extensive background check and post-offer physical examination. 1992 Salary range \$23,214 minimum to \$37,804 maximum. At the time of application ALL APPLICANTS MUST BE STATE OF MICHIGAN LICENSED ADVANCED EMERGENCY MEDICAL TECHNICIANS, and must show current proof of licensure while a fully Advanced Emergency Medical Technician License is required for placement on the eligibility roster, a temporary Advanced Emergency Medical Technician License is sufficient for the submission of the original employment application. Completion of 240 hr. State of Michigan Certified Firefighter program is desired. Applications must be received no later than December 1, 1992, by the Personnel Dept., West Bloomfield Township, 4550 Walnut Lake Road, P.O. Box 250130, West Bloomfield, MI 48099. An Equal Opportunity Employer.

EXECUTIVE ASSISTANT
For insurance agency. Commercial property & casualty experience required. Excellent salary & benefits. Send resume to: PO Box 1300, Birmingham, MI 48012-1300

EXERCISE INSTRUCTOR WANTED
At Laurel Park. Career opportunity. 452-4060

MAINTENANCE PERSON - 3-5 years experience in apts. Knowledgeable in heating, plumbing, electrical, etc. Must be able to handle other duties. Must live on-site. Own tools. Send resume to: P. Envidge, 23870 Middlebelt, Farmington Hills, MI 48336.

ENTRY LEVEL FLORAL DESIGNER
General shop help. 262-1204

FLOOR PERSON - Experienced in stripping, sealing, waxing and spray buffing resilient tile, marble & stone floors. 453-4545

FLORAL DESIGNER
Experienced for upscale Birmingham florist. Part time/full time. Call Cheryl at 647-0455

FLORAL SHOP requires person for entry level position, various duties. Experience helpful, not necessary. W. Bloomfield area, shop. 669-5970

FOREMAN-NIGHT SHIFT
Single and multi-spindle screw machine dept. Experienced in repair, set-up and tool grinding. Phone 931-2000

FACTORY - \$7-\$15/HR
Will train JNI

500 Help Wanted

FULL CHARGE BOOKKEEPER
To perform all accounting functions thru financial statements. Responsibilities include: general ledger, accounts payable, accounts receivable, fixed assets, a inventory, must be self-directed with 5-8 years computerized accounting & Lotus/Excel experience. Send resume & salary history to: Michigan Renter, PO Box 701390, Plymouth, MI 48170

GENERAL HELPER - Full time for Farmington Hills apartment complex. Call Mon-Fri. 9am-5pm, 851-01111

GENERAL HELPER - Full time for Oak Park apartment complex. Call Mon-Fri. 9am-5pm, 967-0284. An Equal Opportunity Employer

GENERAL LABOR
Basement waterproofing, experience helpful but not needed. Excellent working conditions. Start immediately. Call 9am-5pm 261-2058

GENERAL LABOR
Wanted Lake/W. Bloomfield area. Must be 18 years old, send resume for applicants for their 12 hour shift openings. Starting wage - \$3.75 per hour. Apply in person. Precision Coating, Inc. 8120 Gottle St. Walled Lake, MI 48390

GROUPS KEEPER needed for full time position at Muirwood Apartments. Apply with Grand River & Drake, Farmington Hills. 981-6190

GROUPS PERSON
Energetic, reliable. Grounds person needed for apartment community in Farmington Hills. Call 453-4545

GROUPS PERSON
Needed for luxury apartment community in Southfield. For details please call 356-2130. An Equal Opportunity Employer

GROUP HOME
Assistant Manager
In N.E. Livonia seeks assistant manager to supervise developmentally disabled adults. Previous experience should include team based personal care management program. Salary/benefits: 559-6949

HEATING SERVICE PERSON - experienced only, must have own tools, established company with residential heating & air conditioning. Must be 18. Own car & phone a must. \$6/hr. minimum. 278-4395

HENRY'S PIZZA - drivers wanted. Must be 18. Own car & phone a must. \$6/hr. minimum. 278-4395

HIRING IMMEDIATELY American Madsen in Farmington Hills, full-time. Your material or mine. A good job, a good driving record. 27349 W. 7 Mile Rd., Redford. 855-1849

HAIR DESIGNER
E Z Cut Inc. is seeking full time Designer, Assisting Manager, Salesperson, Attendant, Instructor & Massage Therapist. Mail to Health Club Postions, P.O. Box 214756, Auburn Hills, MI 48328

HAIR STYLIST
Experienced, full or part time, for an upscale Plymouth-Canton salon. Call 453-6288

HAIR STYLIST
Experienced, full or part time, for an upscale Plymouth-Canton salon. Call 453-6288

HAIR STYLIST
Experienced, full or part time, for an upscale Plymouth-Canton salon. Call 453-6288

HAIR STYLIST
Experienced, full or part time, for an upscale Plymouth-Canton salon. Call 453-6288

HAIR STYLIST
Experienced, full or part time, for an upscale Plymouth-Canton salon. Call 453-6288

HAIR STYLIST
Experienced, full or part time, for an upscale Plymouth-Canton salon. Call 453-6288

HAIR STYLIST
Experienced, full or part time, for an upscale Plymouth-Canton salon. Call 453-6288

HAIR STYLIST
Experienced, full or part time, for an upscale Plymouth-Canton salon. Call 453-6288

HAIR STYLIST
Experienced, full or part time, for an upscale Plymouth-Canton salon. Call 453-6288

HAIR STYLIST
Experienced, full or part time, for an upscale Plymouth-Canton salon. Call 453-6288

HAIR STYLIST
Experienced, full or part time, for an upscale Plymouth-Canton salon. Call 453-6288

HAIR STYLIST
Experienced, full or part time, for an upscale Plymouth-Canton salon. Call 453-6288

HAIR STYLIST
Experienced, full or part time, for an upscale Plymouth-Canton salon. Call 453-6288

HAIR STYLIST
Experienced, full or part time, for an upscale Plymouth-Canton salon. Call 453-6288

HAIR STYLIST
Experienced, full or part time, for an upscale Plymouth-Canton salon. Call 453-6288

HAIR STYLIST
Experienced, full or part time, for an upscale Plymouth-Canton salon. Call 453-6288

HAIR STYLIST
Experienced, full or part time, for an upscale Plymouth-Canton salon. Call 453-6288

HAIR STYLIST
Experienced, full or part time, for an upscale Plymouth-Canton salon. Call 453-6288

HAIR STYLIST
Experienced, full or part time, for an upscale Plymouth-Canton salon. Call 453-6288

HAIR STYLIST
Experienced, full or part time, for an upscale Plymouth-Canton salon. Call 453-6288

HAIR STYLIST
Experienced, full or part time, for an upscale Plymouth-Canton salon. Call 453-6288

HAIR STYLIST
Experienced, full or part time, for an upscale Plymouth-Canton salon. Call 453-6288

HAIR STYLIST
Experienced, full or part time, for an upscale Plymouth-Canton salon. Call 453-6288

HAIR STYLIST
Experienced, full or part time, for an upscale Plymouth-Canton salon. Call 453-6288

HAIR STYLIST
Experienced, full or part time, for an upscale Plymouth-Canton salon. Call 453-6288

HAIR STYLIST
Experienced, full or part time, for an upscale Plymouth-Canton salon. Call 453-6288

HAIR STYLIST
Experienced, full or part time, for an upscale Plymouth-Canton salon. Call 453-6288

HAIR STYLIST
Experienced, full or part time, for an upscale Plymouth-Canton salon. Call 453-6288

HAIR STYLIST
Experienced, full or part time, for an upscale Plymouth-Canton salon. Call 453-6288

HAIR STYLIST
Experienced, full or part time, for an upscale Plymouth-Canton salon. Call 453-6288

HAIR STYLIST
Experienced, full or part time, for an upscale Plymouth-Canton salon. Call 453-6288

500 Help Wanted

HAIR DESIGNER
E Z Cut Inc. is seeking full time Designer, Assisting Manager, Salesperson, Attendant, Instructor & Massage Therapist. Mail to Health Club Postions, P.O. Box 214756, Auburn Hills, MI 48328

HAIR STYLIST
Experienced, full or part time, for an upscale Plymouth-Canton salon. Call 453-6288

HAIR STYLIST
Experienced, full or part time, for an upscale Plymouth-Canton salon. Call 453-6288

HAIR STYLIST
Experienced, full or part time, for an upscale Plymouth-Canton salon. Call 453-6288

HAIR STYLIST
Experienced, full or part time, for an upscale Plymouth-Canton salon. Call 453-6288

HAIR STYLIST
Experienced, full or part time, for an upscale Plymouth-Canton salon. Call 453-6288

HAIR STYLIST
Experienced, full or part time, for an upscale Plymouth-Canton salon. Call 453-6288

HAIR STYLIST
Experienced, full or part time, for an upscale Plymouth-Canton salon. Call 453-6288

HAIR STYLIST
Experienced, full or part time, for an upscale Plymouth-Canton salon. Call 453-6288

HAIR STYLIST
Experienced, full or part time, for an upscale Plymouth-Canton salon. Call 453-6288

HAIR STYLIST
Experienced, full or part time, for an upscale Plymouth-Canton salon. Call 453-6288

HAIR STYLIST
Experienced, full or part time, for an upscale Plymouth-Canton salon. Call 453-6288

HAIR STYLIST
Experienced, full or part time, for an upscale Plymouth-Canton salon. Call 453-6288

HAIR STYLIST
Experienced, full or part time, for an upscale Plymouth-Canton salon. Call 453-6288

HAIR STYLIST
Experienced, full or part time, for an upscale Plymouth-Canton salon. Call 453-6288

HAIR STYLIST
Experienced, full or part time, for an upscale Plymouth-Canton salon. Call 453-6288

HAIR STYLIST
Experienced, full or part time, for an upscale Plymouth-Canton salon. Call 453-6288

HAIR STYLIST
Experienced, full or part time, for an upscale Plymouth-Canton salon. Call 453-6288

HAIR STYLIST
Experienced, full or part time, for an upscale Plymouth-Canton salon. Call 453-6288

HAIR STYLIST
Experienced, full or part time, for an upscale Plymouth-Canton salon. Call 453-6288

HAIR STYLIST
Experienced, full or part time, for an upscale Plymouth-Canton salon. Call 453-6288

HAIR STYLIST
Experienced, full or part time, for an upscale Plymouth-Canton salon. Call 453-6288

HAIR STYLIST
Experienced, full or part time, for an upscale Plymouth-Canton salon. Call 453-6288

HAIR STYLIST
Experienced, full or part time, for an upscale Plymouth-Canton salon. Call 453-6288

HAIR STYLIST
Experienced, full or part time, for an upscale Plymouth-Canton salon. Call 453-6288

HAIR STYLIST
Experienced, full or part time, for an upscale Plymouth-Canton salon. Call 453-6288

HAIR STYLIST
Experienced, full or part time, for an upscale Plymouth-Canton salon. Call 453-6288

HAIR STYLIST
Experienced, full or part time, for an upscale Plymouth-Canton salon. Call 453-6288

HAIR STYLIST
Experienced, full or part time, for an upscale Plymouth-Canton salon. Call 453-6288

HAIR STYLIST
Experienced, full or part time, for an upscale Plymouth-Canton salon. Call 453-6288

HAIR STYLIST
Experienced, full or part time, for an upscale Plymouth-Canton salon. Call 453-6288

HAIR STYLIST
Experienced, full or part time, for an upscale Plymouth-Canton salon. Call 453-6288

HAIR STYLIST
Experienced, full or part time, for an upscale Plymouth-Canton salon. Call 453-6288

HAIR STYLIST
Experienced, full or part time, for an upscale Plymouth-Canton salon. Call 453-6288

HAIR STYLIST
Experienced, full or part time, for an upscale Plymouth-Canton salon. Call 453-6288

HAIR STYLIST
Experienced, full or part time, for an upscale Plymouth-Canton salon. Call 453-6288

HAIR STYLIST
Experienced, full or part time, for an upscale Plymouth-Canton salon. Call 453-6288

HAIR STYLIST
Experienced, full or part time, for an upscale Plymouth-Canton salon. Call 453-6288

HAIR STYLIST
Experienced, full or part time, for an upscale Plymouth-Canton salon. Call 453-6288

HAIR STYLIST
Experienced, full or part time, for an upscale Plymouth-Canton salon. Call 453-6288

HAIR STYLIST
Experienced, full or part time, for an upscale Plymouth-Canton salon. Call 453-6288

HAIR STYLIST
Experienced, full or part time, for an upscale Plymouth-Canton salon. Call 453-6288

HAIR STYLIST
Experienced, full or part time, for an upscale Plymouth-Canton salon. Call 453-6288

HAIR STYLIST
Experienced, full or part time, for an upscale Plymouth-Canton salon. Call 453-6288

500 Help Wanted

HAIR DESIGNER
E Z Cut Inc. is seeking full time Designer, Assisting Manager, Salesperson, Attendant, Instructor & Massage Therapist. Mail to Health Club Postions, P.O. Box 214756, Auburn Hills, MI 48328

HAIR STYLIST
Experienced, full or part time, for an upscale Plymouth-Canton salon. Call 453-6288

HAIR STYLIST
Experienced, full or part time, for an upscale Plymouth-Canton salon. Call 453-6288

HAIR STYLIST
Experienced, full or part time, for an upscale Plymouth-Canton salon. Call 453-6288

HAIR STYLIST
Experienced, full or part time, for an upscale Plymouth-Canton salon. Call 453-6288

HAIR STYLIST
Experienced, full or part time, for an upscale Plymouth-Canton salon. Call 453-6288

HAIR STYLIST
Experienced, full or part time, for an upscale Plymouth-Canton salon. Call 453-6288

HAIR STYLIST
Experienced, full or part time, for an upscale Plymouth-Canton salon. Call 453-6288

HAIR STYLIST
Experienced, full or part time, for an upscale Plymouth-Canton salon. Call 453-6288

HAIR STYLIST
Experienced, full or part time, for an upscale Plymouth-Canton salon. Call 453-6288

HAIR STYLIST
Experienced, full or part time, for an upscale Plymouth-Canton salon. Call 453-6288

HAIR STYLIST
Experienced, full or part time, for an upscale Plymouth-Canton salon. Call 453-6288

HAIR STYLIST
Experienced, full or part time, for an upscale Plymouth-Canton salon. Call 453-6288

HAIR STYLIST
Experienced, full or part time, for an upscale Plymouth-Canton salon. Call 453-6288

HAIR STYLIST
Experienced, full or part time, for an upscale Plymouth-Canton salon. Call 453-6288

HAIR STYLIST
Experienced, full or part time, for an upscale Plymouth-Canton salon. Call 453-6288

HAIR STYLIST
Experienced, full or part time, for an upscale Plymouth-Canton salon. Call 453-6288

HAIR STYLIST
Experienced, full or part time, for an upscale Plymouth-Canton salon. Call 453-6288

HAIR STYLIST
Experienced, full or part time, for an upscale Plymouth-Canton salon. Call 453-6288

HAIR STYLIST
Experienced, full or part time, for an upscale Plymouth-Canton salon. Call 453-6288

HAIR STYLIST
Experienced, full or part time, for an upscale Plymouth-Canton salon. Call 453-6288

HAIR STYLIST
Experienced, full or part time, for an upscale Plymouth-Canton salon. Call 453-6288

HAIR STYLIST
Experienced, full or part time, for an upscale Plymouth-Canton salon. Call 453-6288

HAIR STYLIST
Experienced, full or part time, for an upscale Plymouth-Canton salon. Call 453-6288

HAIR STYLIST
Experienced, full or part time, for an upscale Plymouth-Canton salon. Call 453-6288

HAIR STYLIST
Experienced, full or part time, for an upscale Plymouth-Canton salon. Call 453-6288

HAIR STYLIST
Experienced, full or part time, for an upscale Plymouth-Canton salon. Call 453-6288

HAIR STYLIST
Experienced, full or part time, for an upscale Plymouth-Canton salon. Call 453-6288

HAIR STYLIST
Experienced, full or part time, for an upscale Plymouth-Canton salon. Call 453-6288

HAIR STYLIST
Experienced, full or part time, for an upscale Plymouth-Canton salon. Call 453-6288

HAIR STYLIST
Experienced, full or part time, for an upscale Plymouth-Canton salon. Call 453-6288

HAIR STYLIST
Experienced, full or part time, for an upscale Plymouth-Canton salon. Call 453-6288

HAIR STYLIST
Experienced, full or part time, for an upscale Plymouth-Canton salon. Call 453-6288

HAIR STYLIST
Experienced, full or part time, for an upscale Plymouth-Canton salon. Call 453-6288

HAIR STYLIST
Experienced, full or part time, for an upscale Plymouth-Canton salon. Call 453-6288

HAIR STYLIST
Experienced, full or part time, for an upscale Plymouth-Canton salon. Call 453-6288

HAIR STYLIST
Experienced, full or part time, for an upscale Plymouth-Canton salon. Call 453-6288

HAIR STYLIST
Experienced, full or part time, for an upscale Plymouth-Canton salon. Call 453-6288

HAIR STYLIST
Experienced, full or part time, for an upscale Plymouth-Canton salon. Call 453-6288

HAIR STYLIST
Experienced, full or part time, for an upscale Plymouth-Canton salon. Call 453-6288

HAIR STYLIST
Experienced, full or part time, for an upscale Plymouth-Canton salon. Call 453-6288

HAIR STYLIST
Experienced, full or part time, for an upscale Plymouth-Canton salon. Call 453-6288

HAIR STYLIST
Experienced, full or part time, for an upscale Plymouth-Canton salon. Call 453-6288

HAIR STYLIST
Experienced, full or part time, for

500 Help Wanted

JANITORIAL HELP

Evening janitorial help needed in the Wayne/Westland area. Experience preferred, but not required. May include some driving. Call to set-up personal interview. 313-729-4158

JANITORIAL MAINTENANCE

Person needed to work in fabric cutting operation including die cutting, fusing and slitting. Experience with fabric handling helpful. Company located in Wayne, MI. Call 9am-5pm, (313) 728-2222

LABORER

Person needed to work in fabric cutting operation including die cutting, fusing and slitting. Experience with fabric handling helpful. Company located in Wayne, MI. Call 9am-5pm, (313) 728-2222

LABORERS - CONSTRUCTION

Concrete experience preferred. CDJ license required. 427-4748

LINE UP YOUR WINNER WORK

GUARANTEED FULL TIME HOURS Female or male. Immediate openings. Good off-season work for landscapers. Call for personal interview with General Manager, Colony Car Wash, Plymouth, MI 455-1011

2nd Shift Operator

Siemens 220V on IBM-VSE systems. RPD-II programming a plus. Send resume and references to: Attention: J. Gillary, Viapac Inc., 35000 Industrial Rd, Livonia, MI 48150 or Fax to 313-525-0659

LATHE HAND

3 yrs. experience, Wixom area. 348-0215

LEASING AGENT

Full time for large apartment complex in Novi. Apply in person, The Springs Apartments, Pontiac Trail between West & Beck Rd.

LEASING AGENT & general office

for Auburn Hills apartment community. Full time position. Apply in person at: 3161 Bloomfield Lane, Livonia, MI 48150 852-4377

LEASING CONSULTANT

Needed for communities in Royal Oak and Troy. Must be able to work with oak floors and fireplaces. Must be service-oriented, enthusiastic and a dedicated team player. Must be able to work weekends. Competitive salary and benefits. Submit resume to: Attention: Amber Management, 3807 Crooks, Royal Oak, MI 48073.

LIBRARIAN II

ADULT SERVICES Starting salary \$29,376 includes comprehensive benefit package. Will coordinate and manage reference and instructional services. For reference collection and coordination of and training of staff on reference services. Will also manage budget and a dedicated team player. Masters degree in Library Science from an ALA accredited school plus one year experience managing a library. Application deadline: Friday, December 18, 1992 at City of Southfield, Personnel Department, 26000 Evergreen Road, Southfield, MI 48076.

DRUG FREE WORKPLACE

An Equal Opportunity Employer LICENSED COSMETOLOGIST needed for assistant positions in very busy salon in Novi. Must be eager to learn, academic class included. Motivated person. Please call Nancy at: 347-3740

LICENSING IN REAL ESTATE

Our students have a 90% pass rate on the State Exam. We GUARANTEE your money back if you don't pass the State Exam. Classes starting soon. Call Lisa Dumas at 356-7111 for details. SOUTH-EASTERN LIFE OF REAL ESTATE

CHANGE YOUR LIFE

Start a new career in real estate today. Call Carol Shelton at Real Estate One, 652-6500 Rochester Troy Area, MI

LIGHT ASSEMBLY

Machine shop, Farmington Hills. Full time. Benefits. Days. Apply at: 24650 N. Industrial Dr. N. of Grand River, between Haggerty & Halsted.

LIGHT INDUSTRIAL

Immediate openings, all shifts for Assemblers & General Laborers. Packaging and transportation. Canton/Belleville Area. Call today: NORRELL TEMPORARY SERVICES 677-2891

LIGHT INDUSTRIAL POSITIONS

We are accepting applications for Assemblers, Packagers, Mail Clerks, Mail Clerks for long and short term assignments in Farmington, Southfield, Detroit & Westland. Call today: NORRELL TEMPORARY SERVICES 677-2891

CORPORATE PERSONNEL SERVICES

Berkley 398-8960 Livonia: 261-1120 No Fee EOE

LONG-TERM light industrial assignment

in Westland. Day & afternoon shifts available. Must be reliable and have dependable transportation. Call ETD Temporary Service 464-7078 An Equal Opportunity Employer

MACHINE DESIGNERS

Several IMMEDIATE openings exist for Designers with experience in one or all of the following areas: Special Machines, Material Handling Equipment, Fixtures, Presses, Shears, and/or Dies. Manual & CAD. Thru: 800 AutoCAD Version 10. Contract and Contract to go Direct positions. Call: 485-4219 (FAX) An Equal Opportunity Employer

MACHINERY CLEANER & PAINTER

6am-3pm. Full time. 591-8383

MACHINE SHOP - full time steady work

available in Milford/Wixom area, day shift - some overtime. Machine operation & shipping & receiving. Recent experience helpful, will train bright self starter. Call Mon. thru Thurs 9-3 473-9305

MAIDS FOR MOTEL

Plymouth & Telegraph area. Must have phone, apply in person only. 9939 Telegraph Rd.

MACHINING PART TIME

Great opportunity. Progressive company. \$8.80/hr. Midshift shift, other shifts available. Right off 1-275. Machining background preferred. CNC operator, experience a plus. Please send resume and references to: P.O. Box 129, Belleville, MI 48111.

SADDLE CREEK APARTMENTS in Novi

is currently seeking a dependable self motivated person for an Entry Level Maintenance position. Responsibilities include: transportation. Recent experience helpful, will train bright self starter. Call Mon. thru Thurs 9-3 473-9305

MACHINING SHOP

Openings in Farmington Hills shop. CNC operators, experienced grinder hand, & inspectors. Full time, steady employment. Some experience helpful. Call Mon-Thurs, 9-3 473-9305

MARKETING RESEARCH ANALYST

Major service organization seeks an experienced marketing professional to join its corporate Market Research team. Duties will include coordinating a wide variety of research programs. Qualified candidates must be degreed and have 3 years' experience in quantitative consumer market research. Knowledge of statistical methods and human resources management a plus. Send resume with salary requirements to: 29200 NORTHWAY HWY, SOUTHFIELD, MI 48034

MATURE responsible person

Send resume to: L.V. Services Corp., P.O. Box 7103, Novi, MI 48078

MESSANGER

Growing company in Southfield needs person with dependable auto to run errands. Must be insured. Call: 358-8707

MILLING MACHINE OPERATOR

Must be experienced in spiral milling. Good pay. 591-1181

500 Help Wanted

MACHINE OPERATORS

Production machine shop seeking hands on Machine Repair Supervisor able to troubleshoot Cincinnati, K & T & Natico type equipment. Must have electrical/mechanical aptitude & be able to read blueprints & schematics. Excellent wage & benefits. Send resume to: Livonia Mfg. Co., 2035 Hilltop Rd., Ferndale, MI 48220

NEVER A MOMENT TOO EARLY

MACHINE REPAIR Production machine shop seeking hands on Machine Repair Supervisor able to troubleshoot Cincinnati, K & T & Natico type equipment. Must have electrical/mechanical aptitude & be able to read blueprints & schematics. Excellent wage & benefits. Send resume to: Livonia Mfg. Co., 2035 Hilltop Rd., Ferndale, MI 48220

PERSON NEEDED for full or part time

Maintenance & Warehouse work in Southfield. Experience & references required. GROSSE POINTE EMPLOYMENT 885-4576

MAIL CLIENT is seeking Assistant

from a mail person to help with daily living skills in his own apt. Early evening shift, 3 hrs. per week. Salary negotiable. Call Margaret Falvo 473-5321

MAINTENANCE FULL-TIME

Management company is seeking an experienced maintenance technician for apartment community. Send resume to, P.O. box # 2480, Farmington Hills, MI 48333

MAINTENANCE

Mature, responsible person to perform required maintenance in luxury suburban apartment community. This is not a seasonal position. Candidate should be experienced in plumbing, heating and electrical. Salaried position. Call 9-11am: 352-3800

MAINTENANCE PERSON & HOUSEKEEPER

Experienced for motel. Apply in person at: 4050 Woodward Ave., Canton, Or call Cathy at: 721-5200

MAINTENANCE PERSON to work in apt

in Westland. Must be experienced in plumbing, electrical, carpentry. \$5/hr. start. 722-4700

MAINTENANCE PERSON

168 hours per week. Assistant. EMI area. Carpentry, light plumbing & electrical experience and references required. SANDEEN COMPANY 647-3250

MAINTENANCE PERSON to work in apt

in Westland. Must be experienced in plumbing, electrical, carpentry. \$5/hr. start. 722-4700

MAINTENANCE PERSON

168 hours per week. Assistant. EMI area. Carpentry, light plumbing & electrical experience and references required. SANDEEN COMPANY 647-3250

MAKE TELEPHONE CALLS

For appointments for reps. NO SELLING. Work in private Lathrup Village office. 10am-3:30pm. Earnings \$10.00 per hour. Training made by reps. (313)443-5522

MANAGEMENT OPPORTUNITIES

Total Petroleum Inc. is seeking qualified individuals interested in expanding their career potential in the petroleum industry. We offer an excellent opportunity for advancement. Forward resume to: Judy Braverman, 36251 Schoolcraft Rd., Livonia, MI 48150

MANAGEMENT OPPORTUNITY

For appointments for reps. NO SELLING. Work in private Lathrup Village office. 10am-3:30pm. Earnings \$10.00 per hour. Training made by reps. (313)443-5522

MORTGAGE LOAN OFFICER

Seeking capable, motivated producer. DELINE MORTGAGE - 484-2299

MORTGAGE LOAN PROCESSOR

needed for companies in Sterling Hills, Plymouth & Birmingham. Conventional, FHA, VA, Glen System a plus. Long term. 645-0900

MORTGAGE LOAN PROCESSOR

National Mortgage Company has immediate opening for experienced mortgage loan processor. Finance company experience would be considered. Excellent working conditions, salary negotiable. Send resume to: United Companies Lending Corp., 5600 Monroe St., Suite 5-206, Sylvania, OH 43560 Attention: Don An Equal Opportunity Employer

MORTGAGE LOAN ORIGINATOR

Needed in Greater Detroit Area. Background in banking or insurance required. Must be self starter and career minded. United Companies is a Financial Company with 44 years experience in mortgage financing. Paid vacation and profit sharing. Send resume to: United Companies Lending Corp., 5600 Monroe St., Suite 5-206, Sylvania, OH 43560 Attention: Don An Equal Opportunity Employer

MORTGAGE ORIGINATORS

Fast growing mortgage corporation is looking for both experienced and entry level mortgage originators. Competitive compensation plan. Blue Cross and car allowance. Send resume to: Capital Mortgage Corporation, 28284 Franklin Rd., Southfield, MI 48034 Or call: 352-1200

MOTEL DESK CLERK

Afternoon shift, telephone - Plymouth area. Apply in person only. Mon-Thurs, 9am-5pm. No phone calls accepted.

NAIL TECHNICIAN wanted, experience

necessary, excellent compensation, apply immediately. 533-1788 Ask for Alana

NIGHT SHIFT SUPERVISOR

Full time for LAM steel fabricating shop. 3-5 years experience required. Excellent pay & benefits. Call Carl 313-757-7707 An Equal Opportunity Employer

NO EXPERIENCE REQUIRED - local

company dealing with electrical maintenance equipment needs 23 people such as: construction workers, route people, factory workers or disinterested people. Corporate position. Permanent full time positions ranging from set-up & display to management. \$55,000 to start with benefits & paid holidays. Apply in person at Circuitous DMA, 32900 Capital, Livonia, OH Farmington, S. of I-96

MARKETING ASSISTANT

A growing Michigan based insurance carrier seeking an individual with a strong personal life background. Responsibilities include: sales, customer service, and administrative support. Send resume with salary requirements to: 31555 Northwestern Highway, PO Box 9093, Farmington Hills, 48333 An Equal Opportunity Employer

MARKETING

High commission for hotel. Experienced. Call: 399-5800

MARKETING/PR TRAINEE

Willing to work Fri, 2-10, Sat 9-5. Must be good dealing with people both in and out of office. Earnings to \$20,000 plus. Work in Farmington Hills location. Call 9:30AM-1:30PM 476-2981

OPERATIONS MANAGER WANTED

College graduate with transportation logistics background. Excellent opportunity with good fringe benefits. If interested send resume to: Box 624, Observer & Eclectic Newspapers 36251 Schoolcraft Rd, Livonia MI 48150

OPERATIONS MANAGER WANTED

College graduate with transportation logistics background. Excellent opportunity with good fringe benefits. If interested send resume to: Box 624, Observer & Eclectic Newspapers 36251 Schoolcraft Rd, Livonia MI 48150

OPTICAL LAB MANAGEMENT

Super optical retailer seeks experienced Lab Manager. Are you tired of the same old optical scene? Are you seeking a dynamic environment that will challenge your personal & professional growth potential? We offer top pay and benefits and are just what you're looking for. If interested? Call 313-726-9198

PACKAGING WE NEED YOU

Must have transportation. Steady work. Some lifting involved. CALL TODAY WOLVERINE STAFFING 358-4270

500 Help Wanted

MARKETING/PUBLIC RELATIONS

Observer & Eclectic Newspapers Service. Experience preferred. Send resume to Box 576 Observer & Eclectic Newspapers 36251 Schoolcraft Rd, Livonia MI 48150

MEAT CUTTER

Part time, Livonia area. Call 473-1000

MEAT CUTTERS

A wholesale distributor has openings for experienced portion meat cutters. Applicants must have good product knowledge and work ethic. Call weekdays after 12pm: 873-1000

MERCHANDISING CO. - entry level

opportunity for aggressive individuals. Full/part time. Experience in retail helpful. 800-237-5959

MOBILE HOME SERVICE PERSONNEL

Must have truck and van and tools. Full time position. Hourly plus mileage. This is a growth position. Apply: 12050 Telegraph, Carleton.

MOLD MAKER

Position available for experienced person knowledgeable in all facets of mold making. Excellent benefit package & steady hours. Please apply or send resume to: Greenleaf Die & Mfg., 8301 Ronda, Troy, Canton, MI 48067

MORTGAGE FORECLOSURES

Bloomfield Hills 48303-0829

PART TIME GROUNDS/HOUSEKEEPER

for Westland apartment complex. Must be reliable. Knowledge of landscaping a plus. Call: 473-9099

PART TIME HELP

Retired or about to assist owner. Some piano keyboard experience preferred, not necessary. 471-1515 An Equal Opportunity Employer

PASSION FOR FASHION

Upscale like-new women's & children boutique seeking enthusiastic, customer oriented individual who likes fast pace. Part/full time position available. Great wages - flexibility. Contact Becky/Canton. 459-1566 Marilyn/Northville. 347-4570

PAYROLL SPECIALIST

Entry level position available for highly motivated, mature individual with 1-2 years experience in payroll. Must possess good math aptitude, related tax forms helpful. Excellent benefit package available. Send resume to: PAYSCH CORP 6960 Orchard Lake Rd., Suite 110 Troy, MI 48064

PEOPLE to pass out flyers to business

Leads walking home to talk. No selling. We provide transportation. Mon thru Fri, 9-5pm. \$10.00 per hour. \$1000.00 per month. \$1000.00 per month. Apply Tues or Wed. 9-3pm. 32003 Plymouth Rd., Livonia, MI 48150

PHARMACEUTICAL REP - \$50K

Resume to: Personnel Data Report, Inc., 1807 E. Big Beaver, Troy, MI 48064

PHARMACY TECH/ASSISTANT

Full or part time. Good salary & benefit package. Apply at: Saw-On Drugs, 6510 Telegraph, Bloomfield Twp. or call: 626-2525

PICTURE FRAMER/EXPERIENCE

preferred. Immediate full or part-time openings for eyes or Sat. shifts. Downtown Birmingham. 542-2555

PICTURE FRAMER - experience in

retail photography. Must be able to train for multi shop management. Call Paul. 921-6834

PREMIER PET SUPPLY in Beverly Hills

is seeking a mature, dependable, hard working individual. Established w/retrofitting. Excellent benefits. No necessary. Good pay. Ray 647-4310

QUALITY ASSURANCE MANAGER

Mature - experienced, with current quality requirements including SPC. Also dealing with automotive firms and related customers. Established supplier. Suburban westside location. Salary & benefits. Resume to: Box 490, Observer & Eclectic Newspapers 36251 Schoolcraft Rd, Livonia MI 48150

QUALITY ASSURANCE ASSISTANT

- manufacturer of precision steel parts. Must be able to do pipe fabrication and pump repairs. Must have a good driving record & high school grad or equivalent. Call for appointment: 313-281-6417

QUALITY CONTROL

in process control for precision sheet metal. Minimum of 3 years experience in Quality Control, experience with all inspection tools, plus Ypsilanti area. Call 9am-4pm. (313) 487-5400

QUALITY CONTROL INSPECTOR

Farmington Hills machine shop has opening for person experienced with hardened precision ground tooling. Excellent benefits. Call Mon-Thurs 9-3 473-9305

QUALITY CONTROL ENGINEER

Steel fabricator needs self-motivated person w/working knowledge of SPC & ISO 9000/01 programs. Must have computer/math skills, benefits, paid vacation & holidays. Call Mon-Thurs 9-3 473-9305

RADIAL DRILL & CNC OPERATORS

wanted. Apply in person, 8am-5pm, Medical Hydraulics, 1419 John R, Troy, MI 48064

REAL ESTATE CAREER AMBITIOUS? CONSCIENTIOUS?

We will train you and start you on a long term high-income career. Call Tony Camilleri, Westland REAL ESTATE ONE 326-2000

RECEPTIONIST, Dispatcher, Bookkeeper

1 person office needs a computer literate, hard working, mature, self-motivated individual. Computer experience helpful, but will train motivated individual. Mail resume or call: Trim Design, 23951 Plymouth Rd., Redford, MI 48239

RECEPTIONIST WITH EXPERIENCE

for W. Bloomfield salon. Good salary. 855-5055

RENTAL AGENT, EXPERIENCED

Medium sized apartment complex. Must have knowledge of leasing and office work. 350-9590

REPORTER Full Time

Needed in Northville newspaper office. Person chosen must possess a Bachelor's Degree or have 1-3 yrs experience in newspaper reporting. This person will gather news stories, cover meetings, write news stories, features and editorials, write headlines, and do photo assignments. May take photographs and dummy pages when necessary. Smoke-free environment. Apply: Homewood Newspapers Personnel Office, 323 E. Grand River Avenue, Howell, MI 48843

RESIDENT AIDES

2 full-time positions available. Home care. Please send resume to: 38910 Six Mile, Livonia. 464-2772

500 Help Wanted

OPTICAL STORE MANAGER

FARMINGTON TOWN CENTER IMMEDIATE OPENING Tuckerman Optical has an excellent opportunity for an experienced store manager. You will start as a store manager immediately! Excellent benefit package. \$21K, medical & paid vacation. Qualified candidate must be an aggressive self-starter with optical experience. Must call Kathy 593-3040

OPTICIAN DEFENSER

EXPERIENCED Excellent career opportunity. Managerial position. Great wages, per apartment. Experienced apartment painters only. 354-6420

PAINT CONTRACTOR

Needs experienced painters to service 1st county area. Great wages, per apartment. Experienced apartment painters only. 354-6420

PAINTER/DRYWALL

Full time paint, drywall & maintenance work for business. Property management company. Call Mon-Fri, 9am-5pm. 569-4070 An Equal Opportunity Employer

PARALEGAL POSITION available in

graduate. Excellent defense law firm. Bachelor's degree & previous case management experience required. Excellent benefit package & steady hours. Please apply or send resume to: Greenleaf Die & Mfg., 8301 Ronda, Troy, Canton, MI 48067

PART TIME HELP

Retired or about to assist owner. Some piano keyboard experience preferred, not necessary. 471-1515 An Equal Opportunity Employer

PROGRAMMER ANALYST

For a corporation in the medical field, seeks a BA degreed developer in a Unix environment. Excellent benefits. Relational Database required. Harper Interface (HLI, APC) desirable. Smoke free work environment. 900 Woodward, Ste 900, Detroit, MI 48201.

PROGRAMMER, OPERATOR for

CNC Bridgeport & NC Lathes. Full-time Assistant Retail Manager positions are now available for individuals with retail management experience. We are looking for energetic, imaginative people with decision making capabilities. Even though you will begin as an assistant manager, we offer rapid advancement opportunities. Call for your resume: Arbor Drugs, Inc., Human Resources Department, P.O. Box 10000, Dearborn, MI 48124. An Equal Opportunity Employer

PROJECT DESIGN ENGINEER -

needed to do pipe fabrication and pump repairs. Must have a good driving record & high school grad or equivalent. Call for appointment: 313-281-6417

PROPERTY MANAGEMENT

Large property management company seeking experienced individuals for Resident Manager positions at local apartment complexes.

500 Help Wanted

DRIVER
Due to rapid growth of J Wholesale...

DRIVERS - OTR
Small private company seeks experienced OTR drivers...

DRIVERS
Tractor/Trailer/Local Route...

DRIVERS NEEDED
CDL License required 3 years over...

DRIVERS - PART TIME
DAVE'S/VENINGS
For Papa Romano's in Canton...

DRIVER WANTED
Cash paid weekly. Local deliveries...

EDM OPERATOR, FULL TIME
4 years minimum experience...

CONTROLS ENGINEER
BSEE, 5 yrs. minimum. A.B. Mod...

FIELD WIRING
3 yrs. minimum. Field experience...

PANEL WIRING
Flexible part-time hours. Wire control...

QUANTUM CONTROLS INC
3899 Schoolcraft
Livonia, MI 48150

500 Help Wanted

DRIVERS - OTR
Small private company seeks experienced OTR drivers...

DRIVERS
Tractor/Trailer/Local Route...

DRIVERS NEEDED
CDL License required 3 years over...

DRIVERS - PART TIME
DAVE'S/VENINGS
For Papa Romano's in Canton...

DRIVER WANTED
Cash paid weekly. Local deliveries...

EDM OPERATOR, FULL TIME
4 years minimum experience...

CONTROLS ENGINEER
BSEE, 5 yrs. minimum. A.B. Mod...

FIELD WIRING
3 yrs. minimum. Field experience...

PANEL WIRING
Flexible part-time hours. Wire control...

QUANTUM CONTROLS INC
3899 Schoolcraft
Livonia, MI 48150

500 Help Wanted

ENGINEER/DRAFTSMAN
Precision Hills manufacturer of...

ENGINEER/TECHNICIAN
Position available for an individual...

ESTATE LIQUIDATORS
Looking for versatile individuals with...

EXECUTIVE ASSISTANT
For insurance agency. Commercial...

EXERCISE INSTRUCTOR WANTED
At Laurel Park. Career opportunity...

MAINTENANCE PERSON - 3-5
years experience in appts. Knowledge...

FRANKLIN FITNESS & RAQUET
Club is looking for mature & responsible...

ENTRY LEVEL FLORAL DESIGNER
general shop help. 262-1234

FLOOR PERSON - Experienced in...

FLORAL DESIGNER
Experienced for upscale Birmingham...

FLORAL SHOP requires person for...

FOREMAN-NIGHT SHIFT
Single and multi-spindle screw machine...

500 Help Wanted

FIREFIGHTER
The Charter Township of West Bloomfield...

GENERAL LABORER
Basement waterproofing experience...

GENERAL LABORER - Full time for...

GENERAL LABORER - Full time for...

GENERAL LABORER - part time for...

GENERAL LABORER - part time for...

GENERAL LABORER - part time for...

GENERAL LABORER - part time for...

GENERAL LABORER - part time for...

GENERAL LABORER - part time for...

GENERAL LABORER - part time for...

500 Help Wanted

FULL CHARGE BOOKKEEPER
To perform all accounting functions...

HAIR DESIGNERS
E Z Cut Inc. is seeking full time...

HAIR STYLIST
Experienced, full or part time, for...

HAIR STYLIST
Experienced, full or part time, for...

HAIR STYLIST
Experienced, full or part time, for...

HAIR STYLIST
Experienced, full or part time, for...

HAIR STYLIST
Experienced, full or part time, for...

HAIR STYLIST
Experienced, full or part time, for...

HAIR STYLIST
Experienced, full or part time, for...

HAIR STYLIST
Experienced, full or part time, for...

HAIR STYLIST
Experienced, full or part time, for...

500 Help Wanted

HAIR DESIGNERS
E Z Cut Inc. is seeking full time...

HAIR STYLIST
Experienced, full or part time, for...

HAIR STYLIST
Experienced, full or part time, for...

HAIR STYLIST
Experienced, full or part time, for...

HAIR STYLIST
Experienced, full or part time, for...

HAIR STYLIST
Experienced, full or part time, for...

HAIR STYLIST
Experienced, full or part time, for...

HAIR STYLIST
Experienced, full or part time, for...

HAIR STYLIST
Experienced, full or part time, for...

HAIR STYLIST
Experienced, full or part time, for...

HAIR STYLIST
Experienced, full or part time, for...

500 Help Wanted

HEALTH CLUB POSITIONS
Auburn Hills/Rochester area...

HELP MANAGERS
No experience. \$295 - \$425 weekly...

HIRING
No experience necessary. So Look...

HOLIDAY HELP
FOR FAST PACED
Fruit baskets, preparation needed...

HOLIDAY HELP
FOR FAST PACED
Fruit baskets, preparation needed...

HOLIDAY HELP
FOR FAST PACED
Fruit baskets, preparation needed...

HOLIDAY HELP
FOR FAST PACED
Fruit baskets, preparation needed...

HOLIDAY HELP
FOR FAST PACED
Fruit baskets, preparation needed...

HOLIDAY HELP
FOR FAST PACED
Fruit baskets, preparation needed...

HOLIDAY HELP
FOR FAST PACED
Fruit baskets, preparation needed...

HOLIDAY HELP
FOR FAST PACED
Fruit baskets, preparation needed...

500 Help Wanted

HOTEL - High rise suburban hotel...

HOTEL MAINTENANCE
If you have a degree to succeed, enjoy...

HVAC SERVICE TECH
3 years experience. Send resume to...

INSTALLATION/WAREHOUSE
position. Looking for full time and part...

INSTALLERS for automotive electronics...

INSURANCE Agency in Farmington...

INSURANCE - Experienced Only

AGENCY POSITIONS
Commercial & Personal Lines CSR's...

CONCORD PERSONNEL
9500 Middlebelt Rd. 478-2200

INSURANCE - Small Property Casualty...

JANITORIAL - Mon-Fri. nights. 2.5...

JANITORIAL PART TIME
Evenings Mon-Fri. 19 Mile & Garfield...

500 Help Wanted

INTERNAL AUDIT
MANAGER
A diversified NYSE company with...

JANITORS - Hiring office cleaners for...

JANITOR WORK WITH PRIDE
Quality cleaners needed. Incentive-based...

KEYCLERK - PART TIME
Experience & conscientious, speedy...

LABORER - PART TIME
For asphalt company in Canton area...

JOBS! JOBS! JOBS!
TOP PAY
No experience needed. Immediate...

WAREHOUSE
GENERAL LABOR
PRESS OPERATORS

JANITORIAL
ASSEMBLY
We offer: Temp-Med Insurance, Overtime Pay...

SNELLING
TEMPORARIES
NEVER A FEE

LIVONIA, 464-2100
SOUTHFIELD, 352-3300
AUBURN HILLS, 373-7500

Aluminum Siding
ALUMINUM & VINYL SIDING
Trim & seamless gutters. Replacement...

ASPHALT
PAVEMASTERS
Save on Fall Bookings! Quality since...

Basement
Waterproofing
ALL SEASON'S Basement Waterproofing...

BRICK, BLOCK, CEMENT
AAA CUSTOM BRICK WORK
Specializing in all masonry repairs...

ADVANCED
Porch & Concrete
All types cement work. Specializing in...

33 Bldg. & Remodeling
A FAMILY BUSINESS
RON DUGAS BLDG.
4846 Crown Point

44 Carpet Laying & Repair
AAA CARPET REPAIR
Seams, Burns, Restretching, Pet &...

55 Chimney Cleaning, Building, Repair
ALL CHIMNEY WORK, Repairs, New, Caps...

66 Electrical
DeRooven Electric
Lic./Ins. All Types of Electrical Work...

66 Excavating
Excavating, trenching, water lines, parking...

72 Fences
D & D QUALITY FENCE CO.
Chain link, all wood, farm fencing...

78 Firewood
AAA - ALL AREAS FIREWOOD
Seasoned, mixed hardwoods. 50 delivered...

81 Christmas Trees
HILLSIDE TREE FARM
Cut your own or pre-cut. Great selection...

82 Doors
DEAL DIRECT - No middleman! I sell & install...

85 Drywall
A-1 DRYWALL
Repairs and New Work. 15 years experience...

86 Decks-Patios Sunrooms
DECKS
LICENSED & INSURED
CALL JOHN 522-5401

86 Cabinetry & Formica
ALL WORK!
471-2600
Johnston Custom Formica

86 Carpet Cleaning & Dyeing
ALPINE CARPET SERVICE
2 rooms & hall, \$35; truck mounted equipment...

86 A & ELECTRICAL
RES. & COMM. BREAKER & fuse panels, plugs, violations...

86 Furniture Finishing & Repair
REPAIR & REFINISH FURNITURE
Any type of Caning and Rush

12 Appliance Service
DEPENDABLE APPLIANCE 24 Hr
Repair Rep. Refrigerators, washers, dryers...

15 Asphalt
PAVEMASTERS
Save on Fall Bookings! Quality since...

24 Basement
Waterproofing
ALL SEASON'S Basement Waterproofing...

27 Brick, Block, Cement
AAA CUSTOM BRICK WORK
Specializing in all masonry repairs...

27 Porch & Concrete
ADVANCED
All types cement work. Specializing in...

33 Bldg. & Remodeling
A FAMILY BUSINESS
RON DUGAS BLDG.
4846 Crown Point

44 Carpet Laying & Repair
AAA CARPET REPAIR
Seams, Burns, Restretching, Pet &...

55 Chimney Cleaning, Building, Repair
ALL CHIMNEY WORK, Repairs, New, Caps...

66 Electrical
DeRooven Electric
Lic./Ins. All Types of Electrical Work...

66 Excavating
Excavating, trenching, water lines, parking...

72 Fences
D & D QUALITY FENCE CO.
Chain link, all wood, farm fencing...

78 Firewood
AAA - ALL AREAS FIREWOOD
Seasoned, mixed hardwoods. 50 delivered...

81 Christmas Trees
HILLSIDE TREE FARM
Cut your own or pre-cut. Great selection...

82 Doors
DEAL DIRECT - No middleman! I sell & install...

85 Drywall
A-1 DRYWALL
Repairs and New Work. 15 years experience...

86 Decks-Patios Sunrooms
DECKS
LICENSED & INSURED
CALL JOHN 522-5401

86 Cabinetry & Formica
ALL WORK!
471-2600
Johnston Custom Formica

86 Carpet Cleaning & Dyeing
ALPINE CARPET SERVICE
2 rooms & hall, \$35; truck mounted equipment...

86 A & ELECTRICAL
RES. & COMM. BREAKER & fuse panels, plugs, violations...

86 Furniture Finishing & Repair
REPAIR & REFINISH FURNITURE
Any type of Caning and Rush

96 Garages
GARAGE DOORS & OPENERS
We sell & service all makes of garage doors...

97 Garage Door Repair
GARAGE DOOR RUST CUT OFF
Galvanized bottom edges installed...

99 Gutters
A-1 GUTTER SPECIALIST
Seamless Gutters, 13 Colors. Installation...

102 Handyman
Male/Female
A-1 HOME IMPROVEMENTS
Roofing, siding, paint, gutters, window...

108 Heating & Cooling
FURNACE INSTALLATIONS
Great prices - Quick Service. Humidifiers...

108 Heating & Cooling
FURNACE INSTALLATIONS
Great prices - Quick Service. Humidifiers...

108 Heating & Cooling
FURNACE INSTALLATIONS
Great prices - Quick Service. Humidifiers...

108 Heating & Cooling
FURNACE INSTALLATIONS
Great prices - Quick Service. Humidifiers...

108 Heating & Cooling
FURNACE INSTALLATIONS
Great prices - Quick Service. Humidifiers...

108 Heating & Cooling
FURNACE INSTALLATIONS
Great prices - Quick Service. Humidifiers...

108 Heating & Cooling
FURNACE INSTALLATIONS
Great prices - Quick Service. Humidifiers...

108 Heating & Cooling
FURNACE INSTALLATIONS
Great prices - Quick Service. Humidifiers...

108 Heating & Cooling
FURNACE INSTALLATIONS
Great prices - Quick Service. Humidifiers...

108 Heating & Cooling
FURNACE INSTALLATIONS
Great prices - Quick Service. Humidifiers...

108 Heating & Cooling
FURNACE INSTALLATIONS
Great prices - Quick Service. Humidifiers...

108 Heating & Cooling
FURNACE INSTALLATIONS
Great prices - Quick Service. Humidifiers...

108 Heating & Cooling
FURNACE INSTALLATIONS
Great prices - Quick Service. Humidifiers...

108 Heating & Cooling
FURNACE INSTALLATIONS
Great prices - Quick Service. Humidifiers...

108 Heating & Cooling
FURNACE INSTALLATIONS
Great prices - Quick Service. Humidifiers...

108 Heating & Cooling
FURNACE INSTALLATIONS
Great prices - Quick Service. Humidifiers...

108 Heating & Cooling
FURNACE INSTALLATIONS
Great prices - Quick Service. Humidifiers...

108 Heating & Cooling
FURNACE INSTALLATIONS
Great prices - Quick Service. Humidifiers...

135 Lawn Maintenance
GORDON'S LAWN & HOME CARE
Lawn care, landscaping & clean-ups...

142 Linoleum
VINYL SHEET GOODS & Vinyl tile installed...

150 Moving & Storage
BOS MOVING & SERVICE INC.
Any Size Job - Reasonable Rates...

165 Painting/Decorating
BRUSH PAINTING CO.
Interior/Exterior. Wallpapering. Lic. & Ins. Free Est.

165 Painting/Decorating
BRUSH PAINTING CO.
Interior/Exterior. Wallpapering. Lic. & Ins. Free Est.

165 Painting/Decorating
BRUSH PAINTING CO.
Interior/Exterior. Wallpapering. Lic. & Ins. Free Est.

165 Painting/Decorating
BRUSH PAINTING CO.
Interior/Exterior. Wallpapering. Lic. & Ins. Free Est.

165 Painting/Decorating
BRUSH PAINTING CO.
Interior/Exterior. Wallpapering. Lic. & Ins. Free Est.

165 Painting/Decorating
BRUSH PAINTING CO.
Interior/Exterior. Wallpapering. Lic. & Ins. Free Est.

165 Painting/Decorating
BRUSH PAINTING CO.
Interior/Exterior. Wallpapering. Lic. & Ins. Free Est.

165 Painting/Decorating
BRUSH PAINTING CO.
Interior/Exterior. Wallpapering. Lic. & Ins. Free Est.

165 Painting/Decorating
BRUSH PAINTING CO.
Interior/Exterior. Wallpapering. Lic. & Ins. Free Est.

165 Painting/Decorating
BRUSH PAINTING CO.
Interior/Exterior. Wallpapering. Lic. & Ins. Free Est.

165 Painting/Decorating
BRUSH PAINTING CO.
Interior/Exterior. Wallpapering. Lic. & Ins. Free Est.

165 Painting/Decorating
BRUSH PAINTING CO.
Interior/Exterior. Wallpapering. Lic. & Ins. Free Est.

165 Painting/Decorating
BRUSH PAINTING CO.
Interior/Exterior. Wallpapering. Lic. & Ins. Free Est.

165 Painting/Decorating
BRUSH PAINTING CO.
Interior/Exterior. Wallpapering. Lic. & Ins. Free Est.

165 Painting/Decorating
BRUSH PAINTING CO.
Interior/Exterior. Wallpapering. Lic. & Ins. Free Est.

165 Painting/Decorating
BRUSH PAINTING CO.
Interior/Exterior. Wallpapering. Lic. & Ins. Free Est.

165 Painting/Decorating
BRUSH PAINTING CO.
Interior/Exterior. Wallpapering. Lic. & Ins. Free Est.

165 Painting/Decorating
BRUSH PAINTING CO.
Interior/Exterior. Wallpapering. Lic. & Ins. Free Est.

165 Painting/Decorating
BRUSH PAINTING CO.
Interior/Exterior. Wallpapering. Lic. & Ins. Free Est.

215 Plumbing
PLUMBING WORK DONE
Reasonable rates. Fast service. No job too small...

215 Plumbing
PLUMBING WORK DONE
Reasonable rates. Fast service. No job too small...

215 Plumbing
PLUMBING WORK DONE
Reasonable rates. Fast service. No job too small...

215 Plumbing
PLUMBING WORK DONE
Reasonable rates. Fast service. No job too small...

215 Plumbing
PLUMBING WORK DONE
Reasonable rates. Fast service. No job too small...

215 Plumbing
PLUMBING WORK DONE
Reasonable rates. Fast service. No job too small...

215 Plumbing
PLUMBING WORK DONE
Reasonable rates. Fast service. No job too small...

215 Plumbing
PLUMBING WORK DONE
Reasonable rates. Fast service. No job too small...

215 Plumbing
PLUMBING WORK DONE
Reasonable rates. Fast service. No job too small...

215 Plumbing
PLUMBING WORK DONE
Reasonable rates. Fast service. No job too small...

215 Plumbing
PLUMBING WORK DONE
Reasonable rates. Fast service. No job too small...

215 Plumbing
PLUMBING WORK DONE
Reasonable rates. Fast service. No job too small...

215 Plumbing
PLUMBING WORK DONE
Reasonable rates. Fast service. No job too small...

215 Plumbing
PLUMBING WORK DONE
Reasonable rates. Fast service. No job too small...

215 Plumbing
PLUMBING WORK DONE
Reasonable rates. Fast service. No job too small...

215 Plumbing
PLUMBING WORK DONE
Reasonable rates. Fast service. No job too small...

215 Plumbing
PLUMBING WORK DONE
Reasonable rates. Fast service. No job too small...

215 Plumbing
PLUMBING WORK DONE
Reasonable rates. Fast service. No job too small...

215 Plumbing
PLUMBING WORK DONE
Reasonable rates. Fast service. No job too small...

215 Plumbing
PLUMBING WORK DONE
Reasonable rates. Fast service. No job too small...

215 Plumbing
PLUMBING WORK DONE
Reasonable rates. Fast service. No job too small...

215 Plumbing
PLUMBING WORK DONE
Reasonable rates. Fast service. No job too small...

253 Snow Removal
RED'S SNOW PLOWING
Residential & Commercial. Reasonable Rates...

253 Snow Removal
RED'S SNOW PLOWING
Residential & Commercial. Reasonable Rates...

253 Snow Removal
RED'S SNOW PLOWING
Residential & Commercial. Reasonable Rates...

253 Snow Removal
RED'S SNOW PLOWING
Residential & Commercial. Reasonable Rates...

253 Snow Removal
RED'S SNOW PLOWING
Residential & Commercial. Reasonable Rates...

253 Snow Removal
RED'S SNOW PLOWING
Residential & Commercial. Reasonable Rates...

253 Snow Removal
RED'S SNOW PLOWING
Residential & Commercial. Reasonable Rates...

253 Snow Removal
RED'S SNOW PLOWING
Residential & Commercial. Reasonable Rates...

253 Snow Removal
RED'S SNOW PLOWING
Residential & Commercial. Reasonable Rates...

253 Snow Removal
RED'S SNOW PLOWING
Residential & Commercial. Reasonable Rates...

253 Snow Removal
RED'S SNOW PLOWING
Residential & Commercial. Reasonable Rates...

253 Snow Removal
RED'S SNOW PLOWING
Residential & Commercial. Reasonable Rates...

253 Snow Removal
RED'S SNOW PLOWING
Residential & Commercial. Reasonable Rates...

253 Snow Removal
RED'S SNOW PLOWING
Residential & Commercial. Reasonable Rates...

253 Snow Removal
RED'S SNOW PLOWING
Residential & Commercial. Reasonable Rates...

253 Snow Removal
RED'S SNOW PLOWING
Residential & Commercial. Reasonable Rates...

253 Snow Removal
RED'S SNOW PLOWING
Residential & Commercial. Reasonable

500 Help Wanted

JANITORIAL HELP
Evening Janitorial help needed in the Wayne County area. Experience preferred, but not required. May include some driving. Call to set-up personal interview.
E.O.E. 313-229-1158

JANITORIAL/MAINTENANCE
Person needed for 3-4 days a week. Evening shift, 3-4 days a week.
Call: 591-1212

JANITORIAL WORK - 5 evenings per week. Starting time 4:30pm. \$5 per hour to Farmington Hills area. Ideal for couple.
1-800-686-8511 or 313-671-8259

JUNIOR INDUSTRIAL Engineer with some automotive background for advanced planning.
Farmingington Hills, MI. Call: 354-9245

LABORER
Person needed to work in fabric cutting operation including die cutting, using and setting. Experience with fabric handling helpful. Company located in Wayne, MI. Call: 9am-5pm, (313) 728-2222

LABORERS - CONSTRUCTION
Concrete experience preferred. CD Licenses available.
427-4749

LINE UP YOUR WINTER WORK
GUARANTEED FULL TIME HOURS. Female or male. Immediate openings. Good off-season work for landscapers. Call for personal interview.
Call: 313-229-1158

LASER PRINTER OPERATOR
Siemens 200 on IBM VPS System. RPL-II programming a plus. Send resume to: 4050 E. Grand River, Attn: J. Gillary, Vispac Inc., 3500 Industrial Rd. Livonia, MI 48150 or Fax to: 313-225-0659

LATHE HAND
3 yrs. experience, Wixom area.
348-0215

LEASING AGENT
Full time for large apartment complex in Novi. Apply in person. The Springs Apartments, Pontiac Trail between West & Beck Rd.

LEASING AGENT & general office for Auburn Hills apartment community. Full time position. Requires a Master's degree.
Call: 3161 Bloomfield Lane, Livonia, MI 48150 852-4377

LEASING CONSULTANT
Needed for communities in Royal Oak and Troy. Requires 2 years experience with oak floors and fireplaces.
Call: 313-229-1158

LIBRARIAN II
ADULT SERVICES
Starting salary \$29,376 includes comprehensive benefit package. Will coordinate and manage reference services, respond to reference collection, and coordination of and training of staff on reference services. Will also manage budget and reference collection.
Call: 313-229-1158

LIBRARIAN II
ADULT SERVICES
Starting salary \$29,376 includes comprehensive benefit package. Will coordinate and manage reference services, respond to reference collection, and coordination of and training of staff on reference services. Will also manage budget and reference collection.
Call: 313-229-1158

LIBRARIAN II
ADULT SERVICES
Starting salary \$29,376 includes comprehensive benefit package. Will coordinate and manage reference services, respond to reference collection, and coordination of and training of staff on reference services. Will also manage budget and reference collection.
Call: 313-229-1158

LIBRARIAN II
ADULT SERVICES
Starting salary \$29,376 includes comprehensive benefit package. Will coordinate and manage reference services, respond to reference collection, and coordination of and training of staff on reference services. Will also manage budget and reference collection.
Call: 313-229-1158

LIBRARIAN II
ADULT SERVICES
Starting salary \$29,376 includes comprehensive benefit package. Will coordinate and manage reference services, respond to reference collection, and coordination of and training of staff on reference services. Will also manage budget and reference collection.
Call: 313-229-1158

LIBRARIAN II
ADULT SERVICES
Starting salary \$29,376 includes comprehensive benefit package. Will coordinate and manage reference services, respond to reference collection, and coordination of and training of staff on reference services. Will also manage budget and reference collection.
Call: 313-229-1158

LIBRARIAN II
ADULT SERVICES
Starting salary \$29,376 includes comprehensive benefit package. Will coordinate and manage reference services, respond to reference collection, and coordination of and training of staff on reference services. Will also manage budget and reference collection.
Call: 313-229-1158

LIBRARIAN II
ADULT SERVICES
Starting salary \$29,376 includes comprehensive benefit package. Will coordinate and manage reference services, respond to reference collection, and coordination of and training of staff on reference services. Will also manage budget and reference collection.
Call: 313-229-1158

LIBRARIAN II
ADULT SERVICES
Starting salary \$29,376 includes comprehensive benefit package. Will coordinate and manage reference services, respond to reference collection, and coordination of and training of staff on reference services. Will also manage budget and reference collection.
Call: 313-229-1158

LIBRARIAN II
ADULT SERVICES
Starting salary \$29,376 includes comprehensive benefit package. Will coordinate and manage reference services, respond to reference collection, and coordination of and training of staff on reference services. Will also manage budget and reference collection.
Call: 313-229-1158

LIBRARIAN II
ADULT SERVICES
Starting salary \$29,376 includes comprehensive benefit package. Will coordinate and manage reference services, respond to reference collection, and coordination of and training of staff on reference services. Will also manage budget and reference collection.
Call: 313-229-1158

LIBRARIAN II
ADULT SERVICES
Starting salary \$29,376 includes comprehensive benefit package. Will coordinate and manage reference services, respond to reference collection, and coordination of and training of staff on reference services. Will also manage budget and reference collection.
Call: 313-229-1158

LIBRARIAN II
ADULT SERVICES
Starting salary \$29,376 includes comprehensive benefit package. Will coordinate and manage reference services, respond to reference collection, and coordination of and training of staff on reference services. Will also manage budget and reference collection.
Call: 313-229-1158

LIBRARIAN II
ADULT SERVICES
Starting salary \$29,376 includes comprehensive benefit package. Will coordinate and manage reference services, respond to reference collection, and coordination of and training of staff on reference services. Will also manage budget and reference collection.
Call: 313-229-1158

LIBRARIAN II
ADULT SERVICES
Starting salary \$29,376 includes comprehensive benefit package. Will coordinate and manage reference services, respond to reference collection, and coordination of and training of staff on reference services. Will also manage budget and reference collection.
Call: 313-229-1158

LIBRARIAN II
ADULT SERVICES
Starting salary \$29,376 includes comprehensive benefit package. Will coordinate and manage reference services, respond to reference collection, and coordination of and training of staff on reference services. Will also manage budget and reference collection.
Call: 313-229-1158

LIBRARIAN II
ADULT SERVICES
Starting salary \$29,376 includes comprehensive benefit package. Will coordinate and manage reference services, respond to reference collection, and coordination of and training of staff on reference services. Will also manage budget and reference collection.
Call: 313-229-1158

LIBRARIAN II
ADULT SERVICES
Starting salary \$29,376 includes comprehensive benefit package. Will coordinate and manage reference services, respond to reference collection, and coordination of and training of staff on reference services. Will also manage budget and reference collection.
Call: 313-229-1158

LIBRARIAN II
ADULT SERVICES
Starting salary \$29,376 includes comprehensive benefit package. Will coordinate and manage reference services, respond to reference collection, and coordination of and training of staff on reference services. Will also manage budget and reference collection.
Call: 313-229-1158

LIBRARIAN II
ADULT SERVICES
Starting salary \$29,376 includes comprehensive benefit package. Will coordinate and manage reference services, respond to reference collection, and coordination of and training of staff on reference services. Will also manage budget and reference collection.
Call: 313-229-1158

LIBRARIAN II
ADULT SERVICES
Starting salary \$29,376 includes comprehensive benefit package. Will coordinate and manage reference services, respond to reference collection, and coordination of and training of staff on reference services. Will also manage budget and reference collection.
Call: 313-229-1158

LIBRARIAN II
ADULT SERVICES
Starting salary \$29,376 includes comprehensive benefit package. Will coordinate and manage reference services, respond to reference collection, and coordination of and training of staff on reference services. Will also manage budget and reference collection.
Call: 313-229-1158

LIBRARIAN II
ADULT SERVICES
Starting salary \$29,376 includes comprehensive benefit package. Will coordinate and manage reference services, respond to reference collection, and coordination of and training of staff on reference services. Will also manage budget and reference collection.
Call: 313-229-1158

LIBRARIAN II
ADULT SERVICES
Starting salary \$29,376 includes comprehensive benefit package. Will coordinate and manage reference services, respond to reference collection, and coordination of and training of staff on reference services. Will also manage budget and reference collection.
Call: 313-229-1158

LIBRARIAN II
ADULT SERVICES
Starting salary \$29,376 includes comprehensive benefit package. Will coordinate and manage reference services, respond to reference collection, and coordination of and training of staff on reference services. Will also manage budget and reference collection.
Call: 313-229-1158

LIBRARIAN II
ADULT SERVICES
Starting salary \$29,376 includes comprehensive benefit package. Will coordinate and manage reference services, respond to reference collection, and coordination of and training of staff on reference services. Will also manage budget and reference collection.
Call: 313-229-1158

LIBRARIAN II
ADULT SERVICES
Starting salary \$29,376 includes comprehensive benefit package. Will coordinate and manage reference services, respond to reference collection, and coordination of and training of staff on reference services. Will also manage budget and reference collection.
Call: 313-229-1158

LIBRARIAN II
ADULT SERVICES
Starting salary \$29,376 includes comprehensive benefit package. Will coordinate and manage reference services, respond to reference collection, and coordination of and training of staff on reference services. Will also manage budget and reference collection.
Call: 313-229-1158

LIBRARIAN II
ADULT SERVICES
Starting salary \$29,376 includes comprehensive benefit package. Will coordinate and manage reference services, respond to reference collection, and coordination of and training of staff on reference services. Will also manage budget and reference collection.
Call: 313-229-1158

LIBRARIAN II
ADULT SERVICES
Starting salary \$29,376 includes comprehensive benefit package. Will coordinate and manage reference services, respond to reference collection, and coordination of and training of staff on reference services. Will also manage budget and reference collection.
Call: 313-229-1158

LIBRARIAN II
ADULT SERVICES
Starting salary \$29,376 includes comprehensive benefit package. Will coordinate and manage reference services, respond to reference collection, and coordination of and training of staff on reference services. Will also manage budget and reference collection.
Call: 313-229-1158

500 Help Wanted

MACHINE OPERATORS
\$6.25 PER HOUR
* Must be able to read micrometers
* CNC experience preferred
FARMINGTON LOCATION
SPENCER PERSONNEL, INC.
559-0110

NEVER A LIE EOE
MACHINE REPAIR
Production machine shop seeking hands on Machine Repair Supervisor able to trouble shoot Cincinnati, MI & T Natick type equipment. Must have electrical/mechanical aptitude & be able to read blueprints & schematics. Excellent wage & benefits. Send resume to: 2200 E. Grand River, Attn: Linda, 48150 or 313-229-1158

PERSON NEEDED for full or part time Maintenance & Warehouse work in Southfield. Experience & references required.
GROSSE POINTE EMPLOYMENT 885-4576

MAIL CLIENT is seeking Assistant from a mail person to help with daily living skills in his own apt. Early evening shift, 3-4 days a week. Negotiable. Call Margaret Faloff 473-5321

MAINTENANCE FULL-TIME
Management company is seeking an experienced maintenance technician for apartment community. Send resume to: P.O. Box # 2480, Farmington Hills, MI 48333

MAINTENANCE
Mature, responsible person to perform required maintenance in luxury suburban apartment community. This is not a live-in position. The date should be experienced in plumbing, heating and electrical. Satisfied position. Call 8-11am: 352-3800

MAINTENANCE PERSON & HOUSEKEEPER
Experienced for motel. Apply in person at 4050 E. Grand River, Canton, MI or call Cathy at: 721-5200

MAINTENANCE PERSON to work in apt. in Westland. Must be experienced in plumbing, electrical, carpentry, and general maintenance. Send resume to: 2200 E. Grand River, Attn: Linda, 48150 or 313-229-1158

MAINTENANCE PERSON
168 hours, complete plant, EMU area. Carpentry, light plumbing & electrical. Experience with residential work. SANBORN COMPANY, 647-3250

MAINTENANCE PERSON
Knowledge of electrical, plumbing, boiler operation, general repairs. Full time. Retirees are encouraged to apply. Non-union. Direct work. Send resume to: Box 664, Observer & Electronic Newspapers, 36251 Schoolcraft Rd., Livonia, MI 48150

MAKE TELEPHONE CALLS
For appointments for reps. NO SELLING. Work in private Lathrup Village office. 10am-3:30pm. Earned commission on high ticket items made by reps. (313)443-5522

MANAGEMENT OPPORTUNITIES
Total Petroleum Inc. is seeking qualified individuals interested in expanding their career and continuing to expand our retail operations. Prior C-store/gasoline station management preferred. We offer an excellent benefit package and advancement opportunities for advancement. Forward resumes to: Judy Braverman, Total Petroleum Inc., 28001 Citrin, Romulus, MI 48174

MANAGEMENT OPPORTUNITIES
Total Petroleum Inc. is seeking qualified individuals interested in expanding their career and continuing to expand our retail operations. Prior C-store/gasoline station management preferred. We offer an excellent benefit package and advancement opportunities for advancement. Forward resumes to: Judy Braverman, Total Petroleum Inc., 28001 Citrin, Romulus, MI 48174

MANAGEMENT OPPORTUNITIES
Total Petroleum Inc. is seeking qualified individuals interested in expanding their career and continuing to expand our retail operations. Prior C-store/gasoline station management preferred. We offer an excellent benefit package and advancement opportunities for advancement. Forward resumes to: Judy Braverman, Total Petroleum Inc., 28001 Citrin, Romulus, MI 48174

MANAGEMENT OPPORTUNITIES
Total Petroleum Inc. is seeking qualified individuals interested in expanding their career and continuing to expand our retail operations. Prior C-store/gasoline station management preferred. We offer an excellent benefit package and advancement opportunities for advancement. Forward resumes to: Judy Braverman, Total Petroleum Inc., 28001 Citrin, Romulus, MI 48174

MANAGEMENT OPPORTUNITIES
Total Petroleum Inc. is seeking qualified individuals interested in expanding their career and continuing to expand our retail operations. Prior C-store/gasoline station management preferred. We offer an excellent benefit package and advancement opportunities for advancement. Forward resumes to: Judy Braverman, Total Petroleum Inc., 28001 Citrin, Romulus, MI 48174

MANAGEMENT OPPORTUNITIES
Total Petroleum Inc. is seeking qualified individuals interested in expanding their career and continuing to expand our retail operations. Prior C-store/gasoline station management preferred. We offer an excellent benefit package and advancement opportunities for advancement. Forward resumes to: Judy Braverman, Total Petroleum Inc., 28001 Citrin, Romulus, MI 48174

MANAGEMENT OPPORTUNITIES
Total Petroleum Inc. is seeking qualified individuals interested in expanding their career and continuing to expand our retail operations. Prior C-store/gasoline station management preferred. We offer an excellent benefit package and advancement opportunities for advancement. Forward resumes to: Judy Braverman, Total Petroleum Inc., 28001 Citrin, Romulus, MI 48174

MANAGEMENT OPPORTUNITIES
Total Petroleum Inc. is seeking qualified individuals interested in expanding their career and continuing to expand our retail operations. Prior C-store/gasoline station management preferred. We offer an excellent benefit package and advancement opportunities for advancement. Forward resumes to: Judy Braverman, Total Petroleum Inc., 28001 Citrin, Romulus, MI 48174

MANAGEMENT OPPORTUNITIES
Total Petroleum Inc. is seeking qualified individuals interested in expanding their career and continuing to expand our retail operations. Prior C-store/gasoline station management preferred. We offer an excellent benefit package and advancement opportunities for advancement. Forward resumes to: Judy Braverman, Total Petroleum Inc., 28001 Citrin, Romulus, MI 48174

MANAGEMENT OPPORTUNITIES
Total Petroleum Inc. is seeking qualified individuals interested in expanding their career and continuing to expand our retail operations. Prior C-store/gasoline station management preferred. We offer an excellent benefit package and advancement opportunities for advancement. Forward resumes to: Judy Braverman, Total Petroleum Inc., 28001 Citrin, Romulus, MI 48174

MANAGEMENT OPPORTUNITIES
Total Petroleum Inc. is seeking qualified individuals interested in expanding their career and continuing to expand our retail operations. Prior C-store/gasoline station management preferred. We offer an excellent benefit package and advancement opportunities for advancement. Forward resumes to: Judy Braverman, Total Petroleum Inc., 28001 Citrin, Romulus, MI 48174

MANAGEMENT OPPORTUNITIES
Total Petroleum Inc. is seeking qualified individuals interested in expanding their career and continuing to expand our retail operations. Prior C-store/gasoline station management preferred. We offer an excellent benefit package and advancement opportunities for advancement. Forward resumes to: Judy Braverman, Total Petroleum Inc., 28001 Citrin, Romulus, MI 48174

MANAGEMENT OPPORTUNITIES
Total Petroleum Inc. is seeking qualified individuals interested in expanding their career and continuing to expand our retail operations. Prior C-store/gasoline station management preferred. We offer an excellent benefit package and advancement opportunities for advancement. Forward resumes to: Judy Braverman, Total Petroleum Inc., 28001 Citrin, Romulus, MI 48174

MANAGEMENT OPPORTUNITIES
Total Petroleum Inc. is seeking qualified individuals interested in expanding their career and continuing to expand our retail operations. Prior C-store/gasoline station management preferred. We offer an excellent benefit package and advancement opportunities for advancement. Forward resumes to: Judy Braverman, Total Petroleum Inc., 28001 Citrin, Romulus, MI 48174

MANAGEMENT OPPORTUNITIES
Total Petroleum Inc. is seeking qualified individuals interested in expanding their career and continuing to expand our retail operations. Prior C-store/gasoline station management preferred. We offer an excellent benefit package and advancement opportunities for advancement. Forward resumes to: Judy Braverman, Total Petroleum Inc., 28001 Citrin, Romulus, MI 48174

MANAGEMENT OPPORTUNITIES
Total Petroleum Inc. is seeking qualified individuals interested in expanding their career and continuing to expand our retail operations. Prior C-store/gasoline station management preferred. We offer an excellent benefit package and advancement opportunities for advancement. Forward resumes to: Judy Braverman, Total Petroleum Inc., 28001 Citrin, Romulus, MI 48174

MANAGEMENT OPPORTUNITIES
Total Petroleum Inc. is seeking qualified individuals interested in expanding their career and continuing to expand our retail operations. Prior C-store/gasoline station management preferred. We offer an excellent benefit package and advancement opportunities for advancement. Forward resumes to: Judy Braverman, Total Petroleum Inc., 28001 Citrin, Romulus, MI 48174

MANAGEMENT OPPORTUNITIES
Total Petroleum Inc. is seeking qualified individuals interested in expanding their career and continuing to expand our retail operations. Prior C-store/gasoline station management preferred. We offer an excellent benefit package and advancement opportunities for advancement. Forward resumes to: Judy Braverman, Total Petroleum Inc., 28001 Citrin, Romulus, MI 48174

MANAGEMENT OPPORTUNITIES
Total Petroleum Inc. is seeking qualified individuals interested in expanding their career and continuing to expand our retail operations. Prior C-store/gasoline station management preferred. We offer an excellent benefit package and advancement opportunities for advancement. Forward resumes to: Judy Braverman, Total Petroleum Inc., 28001 Citrin, Romulus, MI 48174

MANAGEMENT OPPORTUNITIES
Total Petroleum Inc. is seeking qualified individuals interested in expanding their career and continuing to expand our retail operations. Prior C-store/gasoline station management preferred. We offer an excellent benefit package and advancement opportunities for advancement. Forward resumes to: Judy Braverman, Total Petroleum Inc., 28001 Citrin, Romulus, MI 48174

MANAGEMENT OPPORTUNITIES
Total Petroleum Inc. is seeking qualified individuals interested in expanding their career and continuing to expand our retail operations. Prior C-store/gasoline station management preferred. We offer an excellent benefit package and advancement opportunities for advancement. Forward resumes to: Judy Braverman, Total Petroleum Inc., 28001 Citrin, Romulus, MI 48174

MANAGEMENT OPPORTUNITIES
Total Petroleum Inc. is seeking qualified individuals interested in expanding their career and continuing to expand our retail operations. Prior C-store/gasoline station management preferred. We offer an excellent benefit package and advancement opportunities for advancement. Forward resumes to: Judy Braverman, Total Petroleum Inc., 28001 Citrin, Romulus, MI 48174

MANAGEMENT OPPORTUNITIES
Total Petroleum Inc. is seeking qualified individuals interested in expanding their career and continuing to expand our retail operations. Prior C-store/gasoline station management preferred. We offer an excellent benefit package and advancement opportunities for advancement. Forward resumes to: Judy Braverman, Total Petroleum Inc., 28001 Citrin, Romulus, MI 48174

MANAGEMENT OPPORTUNITIES
Total Petroleum Inc. is seeking qualified individuals interested in expanding their career and continuing to expand our retail operations. Prior C-store/gasoline station management preferred. We offer an excellent benefit package and advancement opportunities for advancement. Forward resumes to: Judy Braverman, Total Petroleum Inc., 28001 Citrin, Romulus, MI 48174

MANAGEMENT OPPORTUNITIES
Total Petroleum Inc. is seeking qualified individuals interested in expanding their career and continuing to expand our retail operations. Prior C-store/gasoline station management preferred. We offer an excellent benefit package and advancement opportunities for advancement. Forward resumes to: Judy Braverman, Total Petroleum Inc., 28001 Citrin, Romulus, MI 48174

MANAGEMENT OPPORTUNITIES
Total Petroleum Inc. is seeking qualified individuals interested in expanding their career and continuing to expand our retail operations. Prior C-store/gasoline station management preferred. We offer an excellent benefit package and advancement opportunities for advancement. Forward resumes to: Judy Braverman, Total Petroleum Inc., 28001 Citrin, Romulus, MI 48174

MANAGEMENT OPPORTUNITIES
Total Petroleum Inc. is seeking qualified individuals interested in expanding their career and continuing to expand our retail operations. Prior C-store/gasoline station management preferred. We offer an excellent benefit package and advancement opportunities for advancement. Forward resumes to: Judy Braverman, Total Petroleum Inc., 28001 Citrin, Romulus, MI 48174

MANAGEMENT OPPORTUNITIES
Total Petroleum Inc. is seeking qualified individuals interested in expanding their career and continuing to expand our retail operations. Prior C-store/gasoline station management preferred. We offer an excellent benefit package and advancement opportunities for advancement. Forward resumes to: Judy Braverman, Total Petroleum Inc., 28001 Citrin, Romulus, MI 48174

MANAGEMENT OPPORTUNITIES
Total Petroleum Inc. is seeking qualified individuals interested in expanding their career and continuing to expand our retail operations. Prior C-store/gasoline station management preferred. We offer an excellent benefit package and advancement opportunities for advancement. Forward resumes to: Judy Braverman, Total Petroleum Inc., 28001 Citrin, Romulus, MI 48174

MANAGEMENT OPPORTUNITIES
Total Petroleum Inc. is seeking qualified individuals interested in expanding their career and continuing to expand our retail operations. Prior C-store/gasoline station management preferred. We offer an excellent benefit package and advancement opportunities for advancement. Forward resumes to: Judy Braverman, Total Petroleum Inc., 28001 Citrin, Romulus, MI 48174

MANAGEMENT OPPORTUNITIES
Total Petroleum Inc. is seeking qualified individuals interested in expanding their career and continuing to expand our retail operations. Prior C-store/gasoline station management preferred. We offer an excellent benefit package and advancement opportunities for advancement. Forward resumes to: Judy Braverman, Total Petroleum Inc., 28001 Citrin, Romulus, MI 48174

MANAGEMENT OPPORTUNITIES
Total Petroleum Inc. is seeking qualified individuals interested in expanding their career and continuing to expand our retail operations. Prior C-store/gasoline station management preferred. We offer an excellent benefit package and advancement opportunities for advancement. Forward resumes to: Judy Braverman, Total Petroleum Inc., 28001 Citrin, Romulus, MI 48174

MANAGEMENT OPPORTUNITIES
Total Petroleum Inc. is seeking qualified individuals interested in expanding their career and continuing to expand our retail operations. Prior C-store/gasoline station management preferred. We offer an excellent benefit package and advancement opportunities for advancement. Forward resumes to: Judy Braverman, Total Petroleum Inc., 28001 Citrin, Romulus, MI 48174

500 Help Wanted

MARKETING/PUBLIC RELATIONS
Sales and marketing customers service. Experience preferred. Send resume to Box 576
Observer & Electronic Newspapers
36251 Schoolcraft Rd.
Livonia MI 48150

MEAT CUTTER
Part time. Livonia area.
Call Sam-Zim
471-1500

MEAT CUTTERS
A wholesale distributor has openings for experienced portion meat cutters. Applicants must have good people skills and work oriented. Call weekdays after 12pm: 873-1000

MERCHANDISING CO. - entry level opportunity for aggressive individuals. Full/part time. Experience in retail helpful.
800-237-9599

MOBILE HOME SERVICE PERSON
Must have truck and van with tools. Full time position. Hourly plus mileage. This is a growth position. Apply: Homewood USA, 12050 Telegraph, Carleton.

MOLD MAKER
Position available for experienced person knowledgeable in all facets of mold making. Excellent benefits package & steady hours. Please apply or send resume to: Greenleaf Die & Eng., 6301 Ronda Ave., Carleton, MI 48027

MORTGAGE FORECLOSURES
Miami Valley Bank, Southfield is seeking an experienced Mortgage Foreclosure Technician. Applicants should be knowledgeable in FHA/VA/FHMA/FHLMC and MI. For more details contact Ms. Lofton at: 2900, East 116 between 9am-11am. Substance abuse testing may be part of the pre-employment process, not necessary. 471-1515
An Equal Opportunity Employer

PART TIME GROUND/HOUSEKEEPER
For Westland apartment complex. Full/part time. Experience in retail helpful.
Call: 313-229-1158

PART TIME MGR.
Retired or other to assist owner. Some personal keyboard knowledge preferred, not necessary. 471-1515
An Equal Opportunity Employer

PASSION FOR FASHION
Upscale boutique seeks enthusiastic customer oriented individual who likes fast pace. Part/full time position available. Great wages - flexibility. Contact Becky/Canton, 459-1566 Marilyn/Northville, 347-4570

PAYROLL SPECIALIST
Entry level position available for highly motivated, mature individual with payroll customer service orientation. Must possess good math aptitude, related tax forms helpful. Send resume to: 471-1515

PEOPLE to pass out flyers to businesses. Lots of walking some talking. No selling. We provide transportation. Mon thru Fri, 9-5pm. Classified in Observer & Electronic Newspapers, 36251 Schoolcraft Rd., Livonia MI 48150

PHARMACEUTICAL REP - \$50K
Resume to: Personnel Data Report Agency, 1607 E. Big Beaver, Troy, MI 48068 or 524-1187

PHARMACY TECH/ASSISTANT
Full or part time. Good salary & benefit package. Apply at: Sav-On Drugs, 6510 Telegraph, Bloomfield Twp. or call: 626-2525

PHOTOGRAPHERS
Now hiring full time & part time. Excellent fringe, medical benefits, and a flexible schedule. You must have 35MM camera, filters, lenses plus dependable economical transportation a must. Will train the right people. Call: 476-7355

PICTURE FRAMER/EXPERIENCE
Preferred. Immediate full or part time openings for eyes or Sat. shifts. Downtown Birmingham. 546-2555

PICTURE FRAMER - experience in framing, mounting, and repair. To train for multi shop location. Call Paul. 921-6934

PREMIER PET SUPPLY in Beverly Hills is seeking a mature, dependable hair working individual. Experience w/retail, fringes preferred but not necessary. Good pay. Ray 647-4310

PROPERTY MANAGEMENT
Large property management company seeking experienced individuals for Resident Manager positions at local apartment complexes. Great opportunity for advancement. Send resume to: Property Managers, P.O. Box 5071, Southfield, MI, 48066.

PUMP REPAIR - Mechanical experience. Need to pipe fabrication and pump repairs. Must have a good driving record & high school grad or equivalent. Call for appointment: 313-261-7391

QUALITY ASSURANCE MANAGER
Mature - experienced, with current quality requirements including SPC. Also dealing with automotive firms and related customer packaging supplier. Suburban westside location. Salary & benefits. Resume to: Observer & Electronic Newspapers, 36251 Schoolcraft Rd., Livonia MI 48150

QUALITY ASSURANCE ASSISTANT
Manufacturer of precision steel parts has opening for precision steel parts with current quality assurance with SPC experience. Some office background helpful. Must have current college degree in quality assurance. Salary & benefits. Paid vacation & holidays. Call Mon thru Thurs 9-3 473-9305

QUALITY CONTROL
In process inspector or precision shear in manufacturing of 3 years experience in Quality Control, experience with all inspection tools and plus Ypsilanti area. Call 9am-4pm. (313) 487-5400

QUALITY CONTROL TECHNICIAN
Taking applications Mon-Fri, 10am-5pm. 637-3070

QUALITY CONTROL INSPECTOR - Farmington Hills machine shop has opening for person experienced with hardened precision ground and related work. Send resume to: Quality Control, 313-229-1158

QUALITY CONTROL ENGINEER
Steel fabricator needs self-motivated person w/working knowledge of SPC & ISO 9000/Q1 programs. Must have current college degree in quality assurance/management. Bachelor's degree in Computer Science or related area required. Experience with statistical process control desired. Medical/dental benefits. Competitive salary based on experience. To find out more about this rewarding and challenging opportunity, send your resume & salary requirements to: Macaulays Inc., 15188 W. Mile Rd., Troy, MI 48067-7034
Attention: Career

PROGRAMMER/ANALYST
The MIS Dept. of our Oak Park headquarters seeks a flexible team player with 2-4 years of experience in computer programming, including programming, database design, and ability to successfully interact with customers. Bachelor's degree in Computer Science or related area required. Experience with statistical process control desired. Medical/dental benefits. Competitive salary based on experience. To find out more about this rewarding and challenging opportunity, send your resume & salary requirements to: Macaulays Inc., 15188 W. Mile Rd., Troy, MI 48067-7034
Attention: Career

PROGRAMMER - experienced. Knowledge in Datalux "C" 4GL using DOS, Novell or Unix System. Also needed is Micro Computer Technician for installation of PC hardware, Novell Network, DOS and Windows. If you possess these qualities of either position, please mail resume to: Attn: Personnel Dept., 3000 Town Center, Suite 733, Southfield, MI 48075 or Fax to: 313-229-1158

PROGRAMMER - experienced. Knowledge in Datalux "C" 4GL using DOS, Novell or Unix System. Also needed is Micro Computer Technician for installation of PC hardware, Novell Network, DOS and Windows. If you possess these qualities of either position, please mail resume to: Attn: Personnel Dept., 3000 Town Center, Suite 733, Southfield, MI 48075 or Fax to: 313-229-1158

PROGRAMMER - experienced. Knowledge in Datalux "C" 4GL using DOS, Novell or Unix System. Also needed is Micro Computer Technician for installation of PC hardware, Novell Network, DOS and Windows. If you possess these qualities of either position, please mail resume to: Attn: Personnel Dept., 3000 Town Center, Suite 733, Southfield, MI 48075 or Fax to: 313-229-1158

PROGRAMMER - experienced. Knowledge in Datalux "C" 4GL using DOS, Novell or Unix System. Also needed is Micro Computer Technician for installation of PC hardware, Novell Network, DOS and Windows. If you possess these qualities of either position, please mail resume to: Attn: Personnel Dept., 3000 Town Center, Suite 733, Southfield, MI 48075 or Fax to: 313-229-1158

PROGRAMMER - experienced. Knowledge in Datalux "C" 4GL using DOS, Novell or Unix System. Also needed is Micro Computer Technician for installation of PC hardware, Novell Network, DOS and Windows. If you possess these qualities of either position, please mail resume to: Attn: Personnel Dept., 3000 Town Center, Suite 733, Southfield, MI 48075 or Fax to: 313

502 Help Wanted Dental-Medical

RECEPTIONIST/MANAGER
Female dental needs outgoing person with great people management skills to help develop growing family practice. Dental experience 558-1188

DENTAL ASSISTANT AND HYGIENIST
Assistant needed for full time position in Plymouth office. Great hours and benefits. Mature, hardworking individual. Please call for interview. 458-7175

DENTAL ASSISTANTS & HYGIENISTS
Christmas Dreams can come true when you're a Peak Performer. With only 33 stopping days left till Christmas, let Peak Performers, Inc. help with the extra financial demands that accompanies the holiday season. Experienced individuals, committed to excellence, call PPI today. (Weekly pay) (313) 477-5777

DENTAL ASSISTANT
Part time (Monday, Tuesday & Wednesday) needed for oncology/hematology office. Excellent venipuncture skills a must. Northwest-1/2 mile area. 759-9191

DENTAL ASSISTANT
Part time (Monday, Tuesday & Wednesday) needed for oncology/hematology office. Excellent venipuncture skills a must. Northwest-1/2 mile area. 759-9191

DENTAL ASSISTANT
Part time (Monday, Tuesday & Wednesday) needed for oncology/hematology office. Excellent venipuncture skills a must. Northwest-1/2 mile area. 759-9191

DENTAL ASSISTANT
Part time (Monday, Tuesday & Wednesday) needed for oncology/hematology office. Excellent venipuncture skills a must. Northwest-1/2 mile area. 759-9191

DENTAL ASSISTANT
Part time (Monday, Tuesday & Wednesday) needed for oncology/hematology office. Excellent venipuncture skills a must. Northwest-1/2 mile area. 759-9191

DENTAL ASSISTANT
Part time (Monday, Tuesday & Wednesday) needed for oncology/hematology office. Excellent venipuncture skills a must. Northwest-1/2 mile area. 759-9191

DENTAL ASSISTANT
Part time (Monday, Tuesday & Wednesday) needed for oncology/hematology office. Excellent venipuncture skills a must. Northwest-1/2 mile area. 759-9191

DENTAL ASSISTANT
Part time (Monday, Tuesday & Wednesday) needed for oncology/hematology office. Excellent venipuncture skills a must. Northwest-1/2 mile area. 759-9191

DENTAL ASSISTANT
Part time (Monday, Tuesday & Wednesday) needed for oncology/hematology office. Excellent venipuncture skills a must. Northwest-1/2 mile area. 759-9191

DENTAL ASSISTANT
Part time (Monday, Tuesday & Wednesday) needed for oncology/hematology office. Excellent venipuncture skills a must. Northwest-1/2 mile area. 759-9191

DENTAL ASSISTANT
Part time (Monday, Tuesday & Wednesday) needed for oncology/hematology office. Excellent venipuncture skills a must. Northwest-1/2 mile area. 759-9191

DENTAL ASSISTANT
Part time (Monday, Tuesday & Wednesday) needed for oncology/hematology office. Excellent venipuncture skills a must. Northwest-1/2 mile area. 759-9191

DENTAL ASSISTANT
Part time (Monday, Tuesday & Wednesday) needed for oncology/hematology office. Excellent venipuncture skills a must. Northwest-1/2 mile area. 759-9191

DENTAL ASSISTANT
Part time (Monday, Tuesday & Wednesday) needed for oncology/hematology office. Excellent venipuncture skills a must. Northwest-1/2 mile area. 759-9191

DENTAL ASSISTANT
Part time (Monday, Tuesday & Wednesday) needed for oncology/hematology office. Excellent venipuncture skills a must. Northwest-1/2 mile area. 759-9191

DENTAL ASSISTANT
Part time (Monday, Tuesday & Wednesday) needed for oncology/hematology office. Excellent venipuncture skills a must. Northwest-1/2 mile area. 759-9191

DENTAL ASSISTANT
Part time (Monday, Tuesday & Wednesday) needed for oncology/hematology office. Excellent venipuncture skills a must. Northwest-1/2 mile area. 759-9191

DENTAL ASSISTANT
Part time (Monday, Tuesday & Wednesday) needed for oncology/hematology office. Excellent venipuncture skills a must. Northwest-1/2 mile area. 759-9191

DENTAL ASSISTANT
Part time (Monday, Tuesday & Wednesday) needed for oncology/hematology office. Excellent venipuncture skills a must. Northwest-1/2 mile area. 759-9191

DENTAL ASSISTANT
Part time (Monday, Tuesday & Wednesday) needed for oncology/hematology office. Excellent venipuncture skills a must. Northwest-1/2 mile area. 759-9191

DENTAL ASSISTANT
Part time (Monday, Tuesday & Wednesday) needed for oncology/hematology office. Excellent venipuncture skills a must. Northwest-1/2 mile area. 759-9191

DENTAL ASSISTANT
Part time (Monday, Tuesday & Wednesday) needed for oncology/hematology office. Excellent venipuncture skills a must. Northwest-1/2 mile area. 759-9191

DENTAL ASSISTANT
Part time (Monday, Tuesday & Wednesday) needed for oncology/hematology office. Excellent venipuncture skills a must. Northwest-1/2 mile area. 759-9191

DENTAL ASSISTANT
Part time (Monday, Tuesday & Wednesday) needed for oncology/hematology office. Excellent venipuncture skills a must. Northwest-1/2 mile area. 759-9191

DENTAL ASSISTANT
Part time (Monday, Tuesday & Wednesday) needed for oncology/hematology office. Excellent venipuncture skills a must. Northwest-1/2 mile area. 759-9191

DENTAL ASSISTANT
Part time (Monday, Tuesday & Wednesday) needed for oncology/hematology office. Excellent venipuncture skills a must. Northwest-1/2 mile area. 759-9191

DENTAL ASSISTANT
Part time (Monday, Tuesday & Wednesday) needed for oncology/hematology office. Excellent venipuncture skills a must. Northwest-1/2 mile area. 759-9191

502 Help Wanted Dental-Medical

LPN - Dorvin Nursing Center, a skilled HCR facility in Livonia, has an opening for a treatment nurse every other week-end. This is a 4 hour shift with some flexibility in times. For more information, please contact Cheryl Adams, RN, from 8am to 4pm, Mon. thru Fri. 476-0550

MEDICAL TRANSCRIPTIONIST:
Part time, 8 to 10 hours a week, for Garden City Practice Offices. Send resume to PO Box 896, Garden City MI. 48136-0896

MEDICAL ASSISTANT
Part time afternoon in Livonia. Must be experienced in venipuncture, ERG & Krays. Contact Administrator. 591-0589

MEDICAL ASSISTANT
Experienced. Full time for last paced office. Must be versatile in various office activities. Bingham Farms Area. Call Mary 647-8222

MEDICAL ASSISTANT
Part time (Monday, Tuesday & Wednesday) needed for oncology/hematology office. Excellent venipuncture skills a must. Northwest-1/2 mile area. 759-9191

MEDICAL ASSISTANTS - at least 1 yr. experience. Several positions available at our out-patient hospital clinics in Southfield, Royal Oak, Farmington Hills & Westland. Good pay, part or full time available. Tempo Medical, Marthia, 443-5593

MEDICAL ASSISTANT
Experienced. Part-time for family practice physician at Troy Besomont MOB. 823-8288

MEDICAL ASSISTANT
Needed for Livonia Assistant Clinic. Afternoon shift. X-ray experience preferred. Call between 8am-3pm. 313-425-4800

MEDICAL ASSISTANT (part-time)
Nephrology offices, 3 days/week. Registered phlebotomist preferred. Contact Diane Detter, 932-1170 Harper Associates, 29870 Middlebelt Farmington Hills, MI 48334

MEDICAL BILLER
Needed for busy doctor's office. Experience necessary. Garden City Area. 427-7222

MEDICAL BILLER
Experienced. Full time. Computer literate. MBS preferred. Able to bill for various insurance claims. Bingham Farms Area. Call Mary 647-8222

MEDICAL BILLERS - Will train on MBS. Only the best need apply. 2-5 yrs. experience minimum. Top \$8 for permanent/temporary work. Resume or call: Medical Staff, 29299 Franklin Rd., Southfield, MI 48034

MEDICAL BILLERS
Immediate openings for experience with this fast paced insurance environment. To \$70.00/hour. 646-6168 Uniforce Temporary Services

MEDICAL BILLER
Immediate full time opportunity exists for a highly motivated, non-smoking individual. Medical Biller will be responsible for Medicare, Medicaid, Blue Cross, & all other patient billings. Candidates must have computer skills for insurance collections, accounts receivable & Direct Data Entry. Excellent communication skills & the ability to work as a team player is a must. If you are interested in growing with a leader in the healthcare industry, please send resume in confidence to: 645-0640

MEDI-SPEECH SERVICE
Outpatient Rehabilitation Agency Human Resources Dept. 755 W. Big Beaver, Ste. 404 Troy, MI 48063

MEDICAL GROUP HEALTH
CLAIMS ANALYST
If you are aggressive and have at least 2 years experience paying group medical/dental claims and are not currently being paid for your extra effort, act today. Send your resume to: 645-0640

LASTSIDE T.P.A.
PO BOX 462343
Clinton Township, MI 48046-3243
Only group health claims analyst needed.

MEDICAL INSURANCE BILLER/RECEPTIONIST
for busy ophthalmologist offices in Southfield & West Bloomfield. Full time, mature responsible. Third party billing & experience necessary. Send resume to Box 478 Observer & Electronic Newspapers 36251 Schoolcraft Rd. Livonia MI 48150

MEDICAL RECEPTIONIST
Flexible hours, friendly, good phone manner, willing to train. Redford area. 537-0008

MEDICAL RECEPTIONIST
Experienced. Full time for busy physician group located in Bingham Farms/Southfield Area. Call Mary 647-8222

MEDICAL RECEPTIONISTS - major hospitals in Royal Oak & Southfield in need of 2 receptionists. Full time or part time. Must have 1-2 yrs. experience at front desk. Will train MBS to qualify. Call Tracy, Tempo Medical, Marthia, 443-5593

MEDICAL RECEPTIONIST
Full time position is waiting for you in our busy Troy OB-GYN practice if you possess good clerical skills, as well as computer & medical terminology knowledge. We are offering excellent benefits. Call Marilyn: 828-6081

MEDICAL RECEPTIONIST
Full time, typing, phones, knowledge of medical terminology & computer helpful. Farmington Hills. 471-4254

MEDICAL TRANSCRIPTIONIST
Earn extra cash, flexible hrs. Must have 3 yrs. experience in medical transcription. WordPerfect knowledge helpful. Call between 10am-4:30pm. 561-5568

MEDICAL TRANSCRIPTIONIST
Full time for four physician group practice in Westland. Must be experienced in transcription & computer. Benefits, salary commensurate with experience. Send resume to: P.O. Box 85097, Westland, MI. 48185

MOTIVATED DENTAL OFFICE
needed for experienced RN/LPN. Position at our Southfield office. Full time. Salary based on experience. Call 443-5110

CERTIFIED NURSE AIDES - For West Arbor Tr. Plymouth. Good benefits & all shifts available. Apply today or call: 453-3983

OFFICE MANAGER
Experienced, full-time for high-quality Southfield office. Excellent pay, benefits & bonuses. 355-9800

OPERATING ROOM NURSE
part time with recovery room experience for office surgery suite. Dearborn area. 277-0500

OPTICIAN
Right person can add \$5k to salary. Write: P.O. Box 2400, Birmingham, MI. 48012

502 Help Wanted Dental-Medical

OPTOMETRIC ASSISTANT
with experience, flexible hours, safety negotiating pleasant working conditions, Novi area. 349-0990

PART-TIME Podiatrist Assistant
Two days per week. Assisting in front desk required. Westland area. Call: 722-1570

PHARMACIST
Independent pharmacist needed for a Bloomfield Tr. Pharmacy. All-inclusive package. Send resume to P.O. Box 5835, Bloomington, Indiana, 47401. 334-1217 or call 334-1217

PHYSICAL THERAPY AIDE - full time for Oak Park area. \$5 an hour to start. 427-1660

PHYSICAL THERAPIST
Full time, at per visit rate. Excellent benefits. Opportunity. Oakwood Home Care Services 295-4683

PHYSICAL THERAPIST ASSISTANT
\$28,000-\$32,000/year
Imagine being part of a multidisciplinary team where quality care is the primary and quality vision is enjoyed by the majority.

Professional Services of Michigan (PRSSM) provides therapy services to facilities across the Upper Peninsula and Northern Wisconsin. We currently have an opening for an assistant interested in joining our team. Qualified applicants must possess an Associate Degree in Physical Therapy and have the ability to travel near Marquette or Escanaba, Michigan. Experience in skilled nursing or home health desirable. Relocation and sign-on bonus available. Serious applicants will receive a paid weekend tour of the area. Contact: 313-425-4800

Professional Services of Michigan Karen Weisler, Program Director 712 Chippewa Square, Suite 102 Marquette, MI 49855 1-800-292-0162

POSITIONS AVAILABLE
for rapidly expanding laboratory in the Dearborn/Westland area. Apply in person at DRCL 2345 Merimian, #1321, Westland

PSYCHIATRIC NURSE
Full or part-time needed for JCAHO accredited community mental health center in Redford Tr. Duties include direct client services, staff education & quality assurance activities. Contact Dr. William Hart at 937-9500 An Equal Opportunity Employer

RADIOLOGIC TECHNOLOGISTS
Needed full time for a medical center in Southfield. Must be registered or registry eligible. Good medical benefits. Please apply to: The Nursing Home Group, 2983 Telegraph Rd. (between 9 & 10 Mile)

RADIOLOGIC TECHNOLOGISTS
Positions available for A.R.T. registered technicians. Mammography experience required. Please send resume to: 645-0640

Recruiter/Rad Tech
DMC Health Care Centers 41935 W. 12 Mile Rd. Novi, MI. 48377

WARD CLERK - full time afternoons. Knowledge of medical terminology & ability to maintain accurate records essential. Central supply responsibilities. Send resume to: Winifred, 2500 Farmington Rd. Farmington Hills, MI 48332. Attn: Sally X-RAY TECHS - full time or part when you want. Top dollar for your skills. A number of work sites available in your area. Tempo Medical Inc., Theresa. 443-5594 9-5pm

RECEPTIONIST - Outpatient physical therapy. Immediate opening for full-time receptionist. Experience a plus. Please send resume to: 2500 Farmington Rd. Farmington Hills, MI 48332. Attention: Dawn Sutton at 476-8300

REGISTERED X-RAY TECH
part time, Birmingham area. Call for appointment Mon-Wed-Thru from 8am-2pm only. 647-4425

REIMBURSEMENT SPECIALISTS
Multi-specialty group practice has immediate openings at our Novi Center for experienced reimbursement specialists. Responsible for monitoring reimbursement in an assigned medical department, by ensuring diagnosis and procedure coding. Will work with patient services and patient accounting to analyze problem areas and implement corrective action. BSN or Bachelor of Business Administration preferred with a minimum of 3 years reimbursement experience. Call for resume to: 645-0640

Recruiter/Reimbursement
DMC Health Care Centers 41935 W. 12 Mile Rd. Novi, MI. 48377

Affiliated with The Detroit Medical Center, an Equal Opportunity Employer

RN/LPN
Nurses wanted for quality care. Full-time day shift position. Want to learn the other side of patient care? Call Linda Mirco, or apply to: Cambridge West 19633 Beech Day, Redford 255-1010

An Equal Opportunity Employer

RN
needed for family physician located in Livonia. Part time. Call 464-9200

RN OR LPN
Full time position available in OB/GYN. OB/GYN experience preferred.

Contingent position in Internal Medicine for experienced RN/LPN. Positions at our Southfield office. Please send resume to: 645-0640

Recruiter/OB/GYN
DMC Health Care Centers 41935 W. 12 Mile Rd. Novi, MI. 48377

Affiliated with The Detroit Medical Center, an Equal Opportunity Employer

RNs/LPNs
Adult Home Care Case, Rochester area. Afternoon and midnight shifts. Earn up to \$20/hour! CALL (313) 772-5360

PROFESSIONAL MEDICAL SERVICES
Affiliated with ST. JOHN HOSPITAL AND MEDICAL CENTER. An Equal Opportunity Employer

SOCIAL WORKER
Low term salary. \$25k. DSW or MSW. Long term care experience preferred, but not necessary. Send resume to: E.W. - PO Box 3392 Farmington Hills, MI 48334

502 Help Wanted Dental-Medical

RN'S HOME CARE-INSR
Amicare Home Health Care, a subsidiary of Sisters of Mercy Health Center, is seeking RNs for western Wayne County including Belleville, Canton & Wayne. •Flexible hours •Progressive staff development program •RN's receive 1 yr. med/surgical experience. Call or send resume to: Prof. & Faith Kellum Professional Services Manager Amicare Home HealthCare 905 Airport Blvd. - Ann Arbor, MI 48106 313-741-5705 or 1-800-634-2938

RN'S - \$19 up to \$35
LPN'S - \$13 days, \$14 weeksends. CNA'S - \$6 days, \$7 weekends. First Agency Professionals Staff Relief 335-2141

RN - TEAM LEADER
Amicare Home HealthCare an affiliate of St. Joseph Mercy Hospital has a full time opportunity for the position of RN-Team Leader. Responsibilities include: •Client/caregiver scheduling •Employee evaluations •Record review •Q.A. •Case conference •One year nursing experience with community health background preferred. Competitive salary, excellent benefit package. For more information contact: Clinical Supervisor (313)588-7235

Amicare Home HealthCare An Equal Opportunity Employer

SUBSTANCE ABUSE THERAPISTS
NPL, Inc., a multi location JCAHO accredited outpatient methadone treatment center has immediate openings for full-time, AA, BA, MA degree Substance Abuse Therapists. Please call Mr. Cook, 532-8015.

EEO M/F/H/V Employer

ULTRASOUND TECH
Physician offices near Besomont, need experienced Ultrasound Technicians. Contact Diane Detter, 932-1170 Harper Associates, 29870 Middlebelt Farmington Hills, MI 48334

UNIT TECHNICIAN
Contingent position available to work on an as needed basis in the Emergency Department at Providence Park, Novi. Requires completion of education & quality assurance program or 1 yr. of medically related work experience including medical terminology. Interested candidates should send resume & availability to: Lisa Boerkoel, Coordinator - Human Resources.

PROVIDENCE
47601 Grand River Ave. Novi, MI. 48374 An Equal Opportunity Employer

WARD CLERK - full time afternoons. Knowledge of medical terminology & ability to maintain accurate records essential. Central supply responsibilities. Send resume to: Winifred, 2500 Farmington Rd. Farmington Hills, MI 48332. Attn: Sally X-RAY TECHS - full time or part when you want. Top dollar for your skills. A number of work sites available in your area. Tempo Medical Inc., Theresa. 443-5594 9-5pm

ADIA PERSONNEL SERVICES
722-9060 or 382-2342

Assistant Account Rep
Large insurance agency seeks individual for entry level position. Some experience helpful, will train. Must be motivated with good typing skills. People skills. Send resume to: Personnel Dept., P.O. Box 53009, Livonia 48153-0099. Equal Opportunity Employer

AUTO BOOKKEEPER
Rapidly growing dealership in the Farmington Hills area is looking for an experienced AUTO BOOKKEEPER that can keep up with a fast pace. If you are an ambitious, hard working individual, we have the perfect position for you!

EXCELLENT PAY & BENEFITS!

ANDERSON'S
A good place to work. A good place to do business. Call Sandy: 858-2300 or 478-8200 or FAX RESUME to: (313) 858-8538

AUTOMOTIVE BILLER
GM auto dealer needs experienced car biller. Competitive salary & benefits. Van Horn Bldg. Inc., 3939 S. Wayne Rd. Wayne, MI. 313-729-2000

BIRMINGHAM AREA. Part-time individual for clerical & typing skills. Resume to: Administrative Assistant P.O. Box 3027 Birmingham, MI 48012-3027

BLOOMFIELD HILLS law firm seeks clerk for part time job. Call Joe Harding III 642-3500 Observer & Electronic Newspapers 36251 Schoolcraft Rd. Livonia MI 48150

BOOKKEEPER/OFFICE MANAGER
for 1 person office. Job shop experience preferred. Applicant must have previous bookkeeping experience including payroll. Average 40-45 hrs. per week. Good pay & benefits depending on experience. Send resume to: Box 618, Observer & Electronic Newspapers 36251 Schoolcraft Rd. Livonia MI 48150

BOOKKEEPER/PART TIME
Seeking experienced individual for clerical position. Working knowledge of all payroll tax returns. 454-5418

BOOKKEEPER
Part time. CPA firm needs individual with strong computer & bookkeeping skills. Must have 2 yrs. experience. CPA, 6960 Orchard Lake Rd. S.335, W. Bloomfield MI 48322.

BOOKKEEPERS CLERKS
Now hiring at all levels for experience in bookkeeping, accounts receivable, payroll, OR collections. Why not get started now, temping for Holiday dollars, while we help you with your permanent job search? Work available with SUB-URBAN FIRMS as well as DETROIT FIRMS.

CALL TODAY! 354-2410

ACCOUNTANTS ONE
Agency Fee Paid

BOOKKEEPING POSITION - Full time for office. Supply company located in Novi. Must know accounts payable, data entry & typing. Great benefits. Call between 9am-5pm, Mon-Fri. 344-1811

BOOKKEEPER
Fast growing Canton company looking for energetic and self-motivated person. Experience in bank reconciliation, payroll, general ledger, taxes, etc. Please send resume and salary requirements to: Observer & Electronic Newspapers 36251 Schoolcraft Rd. Livonia MI 48150

CLERICAL-Northwest Detroit manufacturing firm has immediate part time clerical position available. Duties include typing, filing & telephone. Knowledge of PC software a plus. Please send resume in confidence to: Box 698, Observer & Electronic Newspapers 36251 Schoolcraft Rd. Livonia MI 48150

ADMINISTRATIVE ASSISTANT
Suburban advertising agency needs part time clerical position. \$9/hr. Call Sharon at 357-0037 Uniforce Temporary Services

ADMINISTRATIVE ASSISTANT
Temporary part time for busy Southfield Department of a Detroit Start immediately thru early March. Non smoker. Apply at: 26111 Evergreen Rd., Ste 302, between 1&2 pm only. Interview call back basis only.

ADMINISTRATIVE ASSISTANT
Birmingham investment firm is seeking detail oriented individual with strong computer & communication skills to assist portfolio manager. Figure aptitude & securities experience preferred. Call Ms. Pesta at: 394-3043, Birmingham, MI 48012-3043

504 Help Wanted Office-Clerical

ADIA has Immediate Openings for: •Word Processing Secretaries •Receptionists •Data Entry •Switchboard Operators Full & part-time temporary positions available for the Plymouth/Canton area. Call for an appointment. 525-0330

ADIA Personnel Services Never a Fee

ADMINISTRATIVE ASSISTANT
WE WILL PAY YOU RENT! Large apartment community has an immediate opening. Experience with Microsoft Word & good organizational skills needed. The individual hired must live on-site at independent Green Apartments. Please send resume to: 36700 Grand River, Farmington Hills, MI 48335

ADMINISTRATIVE ASSISTANTS WORD PROCESSORS (All Software)
Immediate openings. Long & short term jobs. Some temporary to permanent.

CONTEMPRA 583-9500

ADMINISTRATIVE SUPPORT
NO FEE

ADMINISTRATIVE ASSISTANT
•Engineering Support Staff •Administrative support in Quality Control •Marketing and/or Research Assistant

EXECUTIVE RECRUITERS
CALL: 357-7023 (OR FAX RESUME TO: 357-5379)

APPLY NOW WORD PROCESSORS

•WordPerfect •Display Write •Lotus 1-2-3

Benefits package offered. Call now for an appointment.

ADIA PERSONNEL SERVICES 722-9060 or 382-2342

Assistant Account Rep
Large insurance agency seeks individual for entry level position. Some experience helpful, will train. Must be motivated with good typing skills. People skills. Send resume to: Personnel Dept., P.O. Box 53009, Livonia 48153-0099. Equal Opportunity Employer

AUTO BOOKKEEPER
Rapidly growing dealership in the Farmington Hills area is looking for an experienced AUTO BOOKKEEPER that can keep up with a fast pace. If you are an ambitious, hard working individual, we have the perfect position for you!

EXCELLENT PAY & BENEFITS!

ANDERSON'S
A good place to work. A good place to do business. Call Sandy: 858-2300 or 478-8200 or FAX RESUME to: (313) 858-8538

AUTOMOTIVE BILLER
GM auto dealer needs experienced car biller. Competitive salary & benefits. Van Horn Bldg. Inc., 3939 S. Wayne Rd. Wayne, MI. 313-729-2000

BIRMINGHAM AREA. Part-time individual for clerical & typing skills. Resume to: Administrative Assistant P.O. Box 3027 Birmingham, MI 48012-3027

BLOOMFIELD HILLS law firm seeks clerk for part time job. Call Joe Harding III 642-3500 Observer & Electronic Newspapers 36251 Schoolcraft Rd. Livonia MI 48150

BOOKKEEPER/OFFICE MANAGER
for 1 person office. Job shop experience preferred. Applicant must have previous bookkeeping experience including payroll. Average 40-45 hrs. per week. Good pay & benefits depending on experience. Send resume to: Box 618, Observer & Electronic Newspapers 36251 Schoolcraft Rd. Livonia MI 48150

BOOKKEEPER/PART TIME
Seeking experienced individual for clerical position. Working knowledge of all payroll tax returns. 454-5418

BOOKKEEPER
Part time. CPA firm needs individual with strong computer & bookkeeping skills. Must have 2 yrs. experience. CPA, 6960 Orchard Lake Rd. S.335, W. Bloomfield MI 48322.

BOOKKEEPERS CLERKS
Now hiring at all levels for experience in bookkeeping, accounts receivable, payroll, OR collections. Why not get started now, temping for Holiday dollars, while we help you with your permanent job search? Work available with SUB-URBAN FIRMS as well as DETROIT FIRMS.

CALL TODAY! 354-2410

ACCOUNTANTS ONE
Agency Fee Paid

BOOKKEEPING POSITION - Full time for office. Supply company located in Novi. Must know accounts payable, data entry & typing. Great benefits. Call between 9am-5pm, Mon-Fri. 344-1811

BOOKKEEPER
Fast growing Canton company looking for energetic and self-motivated person. Experience in bank reconciliation, payroll, general ledger, taxes, etc. Please send resume and salary requirements to: Observer & Electronic Newspapers 36251 Schoolcraft Rd. Livonia MI 48150

CLERICAL-Northwest Detroit manufacturing firm has immediate part time clerical position available. Duties include typing, filing & telephone. Knowledge of PC software a plus. Please send resume in confidence to: Box 698, Observer & Electronic Newspapers 36251 Schoolcraft Rd. Livonia MI 48150

ADMINISTRATIVE ASSISTANT
Suburban advertising agency needs part time clerical position. \$9/hr. Call Sharon at 357-0037 Uniforce Temporary Services

ADMINISTRATIVE ASSISTANT
Temporary part time for busy Southfield Department of a Detroit Start immediately thru early March. Non smoker. Apply at: 26111 Evergreen Rd., Ste 302, between 1&2 pm only. Interview call back basis only.

QC1 AVIS FORD QC1

CHAIRMAN AWARD WINNER

\$ WHAT DO A, X AND Z PLAN BUYERS WANT? \$
THEY WANT MORE MONEY

FOR THEIR TRADE-INS

A Lot More Money

AVIS FORD GIVES MORE FOR EVERY TRADE-IN!

IN THE FIRST 10 MONTHS OF 1992 OVER 1300 A, X AND Z PLAN BUYERS

Have traded in their USED CARS and trucks at AVIS FORD. The reason continues to be that AVIS FORD gives more money on each and every trade in.

SPECIAL OF THE MONTH!!
NEW 1993 TAURUS GL
4 DOOR SEDAN



Power steering, power brakes, tinted glass, air bag, power drivers seat, speed control, tilt steering, automatic with overdrive trans, air conditioning, AM/FM stereo cassette, cast aluminum wheels, rear window defroster, light group, GL decor equipment package, exterior accent group, body side moldings, clearcoat paint, side window demister, dual electric remote control mirrors, child safety locks.

WAS \$19,887

IS **\$15,544***

"NEW TAURUS SHO Automatics Now in Stock!"

\$ Have Your Trade-In Appraised at AVIS Before You Buy! \$

<p>NEW 1993 ESCORT GT</p>  <p>Air, power steering, power brakes, tinted glass, 4 wheel disc brakes, AM/FM stereo cassette, power moonroof, premium sound system, rear window defroster, tilt steering, tachometer/instrumentation, sport handling, aluminum wheels, console, rear spoiler.</p> <p>WAS \$14,231 IS \$11,307*</p>	<p>NEW 1993 PROBE</p>  <p>Air, power steering, power brakes, tinted glass, rear window defroster, automatic, speed control, tilt steering, convenience group, dual electric remote mirrors, AM/FM stereo, performance instrument cluster, driver's side air bag.</p> <p>WAS \$16,193 IS \$13,999*</p>	<p>NEW 1993 THUNDERBIRD LX</p>  <p>Air, power steering and brakes, tinted glass, temperature control, rear defroster, power antenna, cast aluminum wheels, automatic overdrive transmission, tilt, cruise, console, fog lamps, side molding, dual electric remote control mirrors, instrumentation, interval wipers, power door group, illuminated entry.</p> <p>WAS \$17,030 IS \$14,404*</p>	<p>NEW 1992 AEROSTAR XL PLUS WAGON</p>  <p>Air, power steering and brakes, tinted glass, air bag, rear anti-lock brakes, AM/FM stereo, 7 passenger with dual captain's chairs, privacy glass, speed control, tilt steering, automatic with overdrive, clearcoat paint, electric rear window defroster, fold away mirrors, front spoiler, convenience group, courtesy lamps, instrumentation, super cooling.</p> <p>WAS \$18,993 IS \$14,474*</p>
<p>NEW 1993 RANGER 4x2 XLT</p>  <p>Air, power steering, power brakes, tinted glass, rear anti-lock brakes, AM/FM stereo cassette, XLT trim, sliding rear window, floor console, chrome rear step bumper, cast aluminum wheels, clearcoat paint, spoiler, moldings, cargo box lights, light group, scuff plates.</p> <p>WAS \$12,833 IS \$10,282*</p>	<p>NEW 1993 RANGER XLT SUPER CAB 4x2</p>  <p>Air, power steering, power brakes, tinted glass, rear anti-lock brakes, AM/FM stereo cassette, XLT trim, sliding rear window, floor console, chrome rear step bumper, cast aluminum wheels, clearcoat paint, super engine cooling, instrumentation, spoiler, moldings, cargo box lights, light group, scuff plates, rear jump seat, 3.0 V6 engine, flip pivoting quarter windows.</p> <p>WAS \$15,028 IS \$12,464*</p>	<p>NEW 1993 F-150 4x2 STYLESIDE PICKUP</p>  <p>Power steering, power brakes, rear anti-lock brakes, tinted glass, XL trim, instrumentation, moldings, vent windows, power point, interval wipers, scuff plates, dome light, courtesy lights.</p> <p>WAS \$11,618 IS \$9802*</p>	<p>NEW 1993 F-150 4x2 SUPER CAB PICKUP</p>  <p>XL trim, power steering, power brakes, tinted glass, rear anti-lock brakes, automatic with overdrive, V8 engine, trailer tow package, air, argent rear step bumper, rear bench seat, cargo box light, courtesy lights, instrumentation, vent windows, power point, moldings, interval wipers.</p> <p>WAS \$18,204 IS \$15,401*</p>

"LOWEST PICKUP PRICES IN METRO DETROIT!!"

<p>NEW 1993 ESCORT LX 4 DOOR</p>  <p>Power steering, power brakes, body side molding, console, rear window defroster, AM/FM stereo, reclining bucket seats, interval wipers, side window demister, clearcoat paint, light group.</p>	<p>NEW 1993 ESCORT LX 3 DOOR</p>  <p>Power steering, power brakes, tinted glass, body side moldings, console, rear window defroster, AM/FM stereo cassette, reclining bucket seats, interval wipers, side window demister, clearcoat paint, light convenience group.</p>
<p>YOU PICK!!</p> <p>\$9242*</p> <p>ANY OF THESE ALL NEW 1993 ESCORT LX MODELS</p>	
<p>NEW 1993 ESCORT LX 5 DOOR</p>  <p>Power steering, power brakes, tinted glass, body side molding, console, rear window defrost, AM/FM stereo, interval wipers, side window demister, clearcoat paint, light convenience group.</p>	<p>NEW 1993 ESCORT 4 DOOR WAGON</p>  <p>Deluxe luggage rack, wagon group, rear window washer/wiper, power steering, power brakes, tinted glass, body side molding, console, rear window defroster, AM/FM stereo, reclining bucket seats, interval wipers, side window demister, clearcoat paint, light group.</p>

NEW 1993 TEMPO GL 2 DOOR SEDAN



Air, power steering, power brakes, tinted glass, air bag, rear anti-lock brakes, AM/FM stereo, 7 passenger with dual captain's chairs, privacy glass, speed control, tilt steering, automatic with overdrive, clearcoat paint, electric rear window defroster, fold away mirrors, front spoiler, convenience group, courtesy lamps, instrumentation, super cooling.

WAS \$12,042

IS **\$8827***

*Plus tax, title, license and destination. Rebate, if applicable, included. Retail sales only. Picture may not represent actual vehicle. Sale ends 11/30/92.



FREE TANK OF GAS with every new vehicle purchase from stock.

Avis Ford

"The Dealership With A Heart"

TELEGRAPH RD. Just North of 12 MILE RD., SOUTHFIELD
 OPEN MON. & THURS. 'TIL 9 P.M.

CALL
 1-800-358-AVIS
 or

355-7500

504 Help Wanted Office-Clerical

LEGAL WORD PROCESSOR, \$21,000 Afternoon shift. Word Perfect experience, benefits 772-8760.

NATIONAL LEASING COMPANY seeking energetic, hardworking individual for lease documentation processing and general clerical duties.

NOW HIRING! RECEPTIONISTS Professional individuals with good communication skills. Short & long term jobs available.

CONTEMPRA 583-9500 OFFICE MANAGER Experienced in office management, bookkeeping and payroll.

OFFICE MANAGER/RECEPTIONIST Immediate opening for mature, dependable team player to keep busy office running smoothly.

PARALEGAL \$25,000 Prestigious suburban firm, medical malpractice experience, outstanding opportunity.

SNELLING PERSONNEL SERVICES PART TIME CLERICAL POSITION To \$7.50 HOUR, FEED PAID Accurate typing and office skills with word processing needed.

PERSONNEL ASSISTANT A rewarding clerical position with an international company. Good word processing and math skills.

PERSONNEL RECEPTIONIST Full-time receptionist position requires multi-talented individual to manage busy front office.

RECEPTIONIST/CLERICAL - part-time Computer/office machine experience preferred. 2-3 days per week, midday hours.

RECEPTIONIST/ASSISTANT for medical practice. M-F, 8am-5pm. Mon & Wed mornings. Thu & Fri afternoon. Call 354-0057

RECEPTIONIST Wanted part for Merle Norman in Troy. Experience preferred. Please call for interview. Box 524

RECEPTIONIST for Rochester real estate office 3 afternoons & PM Sat. 9-5. Sun 10-5. Good phone techniques and typing required. Ask for Dotly. 656-6503

RECEPTIONIST Needed for busy Bloomfield office. Must be able to answer multi-line phones and type 45 wpm, 30 hours per week. \$6/hour. 932-4172

RECEPTIONISTS needed for the Plymouth/Canton area. Must have previous experience. We offer long term and temp-to-perm assignments with excellent pay. ETO Temporary Services. An Equal Opportunity Employer.

RECEPTIONIST Bloomfield Hills firm seeks highly motivated pleasant individual to answer phone & general office. Please send resume to box 524

RECEPTIONIST Full time for paper & bag distribution. Must be able to direct multiple lines and perform general office functions. Send resume to Box 634

RECEPTIONIST Large property management company is seeking energetic individuals for entry level Secretarial positions. Must have experience with word processing and data entry.

RECEPTIONIST/CLERICAL - part-time Computer/office machine experience preferred. 2-3 days per week, midday hours. 455-6870

RECEPTIONIST/ASSISTANT for medical practice. M-F, 8am-5pm. Mon & Wed mornings. Thu & Fri afternoon. Call 354-0057

RECEPTIONIST Wanted part for Merle Norman in Troy. Experience preferred. Please call for interview. Box 524

RECEPTIONIST for Rochester real estate office 3 afternoons & PM Sat. 9-5. Sun 10-5. Good phone techniques and typing required. Ask for Dotly. 656-6503

RECEPTIONIST Needed for busy Bloomfield office. Must be able to answer multi-line phones and type 45 wpm, 30 hours per week. \$6/hour. 932-4172

RECEPTIONISTS needed for the Plymouth/Canton area. Must have previous experience. We offer long term and temp-to-perm assignments with excellent pay. ETO Temporary Services. An Equal Opportunity Employer.

RECEPTIONIST Bloomfield Hills firm seeks highly motivated pleasant individual to answer phone & general office. Please send resume to box 524

RECEPTIONIST Full time for paper & bag distribution. Must be able to direct multiple lines and perform general office functions. Send resume to Box 634

RECEPTIONIST Large property management company is seeking energetic individuals for entry level Secretarial positions. Must have experience with word processing and data entry.

RECEPTIONIST/CLERICAL - part-time Computer/office machine experience preferred. 2-3 days per week, midday hours. 455-6870

RECEPTIONIST/ASSISTANT for medical practice. M-F, 8am-5pm. Mon & Wed mornings. Thu & Fri afternoon. Call 354-0057

504 Help Wanted Office-Clerical

PROFESSIONAL Service Firm located in Farmington Hills is seeking a Receptionist. Outstanding opportunity for an energetic, outgoing individual.

RECEPTIONIST PART TIME Pleasant Southfield office seeks part time receptionist for general office work.

RECEPTIONIST Needed for downtown Birmingham office. Full time, excellent position. Send resume to PO Box 1599

RECEPTIONIST For busy property management company. Computer experience important, non smoker, good benefits.

RECEPTIONIST WITH BOARD An Arbor sales office has immediate opening. Experience necessary.

RECEPTIONIST - Fast paced Southfield company desires Receptionist with superior telephone manners & pleasant personality.

RECEPTIONIST - full time, experienced. Pleasant working environment. Birmingham area. Send resume to: Box 656

RECEPTIONIST - Immediate opening for full time Receptionist in fast paced office. Good phone personality & typing ability a must.

RECEPTIONIST Needed for busy Royal Oak office. Answer phones, greet clients, light typing, word processing.

RECEPTIONIST Entry level receptionist position is looking for a motivated person with excellent communication skills.

RECEPTIONIST A progressive Berkley company is looking for a motivated person with excellent communication skills.

RECEPTIONIST Full time entry level opening for enthusiastic individual with professional appearance, proper telephone etiquette.

RECEPTIONIST Needed for busy Bloomfield office. Must be able to answer multi-line phones and type 45 wpm, 30 hours per week. \$6/hour. 932-4172

RECEPTIONISTS needed for the Plymouth/Canton area. Must have previous experience. We offer long term and temp-to-perm assignments with excellent pay. ETO Temporary Services. An Equal Opportunity Employer.

RECEPTIONIST Bloomfield Hills firm seeks highly motivated pleasant individual to answer phone & general office. Please send resume to box 524

RECEPTIONIST Full time for paper & bag distribution. Must be able to direct multiple lines and perform general office functions. Send resume to Box 634

RECEPTIONIST Large property management company is seeking energetic individuals for entry level Secretarial positions. Must have experience with word processing and data entry.

RECEPTIONIST/CLERICAL - part-time Computer/office machine experience preferred. 2-3 days per week, midday hours. 455-6870

RECEPTIONIST/ASSISTANT for medical practice. M-F, 8am-5pm. Mon & Wed mornings. Thu & Fri afternoon. Call 354-0057

RECEPTIONIST Wanted part for Merle Norman in Troy. Experience preferred. Please call for interview. Box 524

RECEPTIONIST for Rochester real estate office 3 afternoons & PM Sat. 9-5. Sun 10-5. Good phone techniques and typing required. Ask for Dotly. 656-6503

RECEPTIONIST Needed for busy Bloomfield office. Must be able to answer multi-line phones and type 45 wpm, 30 hours per week. \$6/hour. 932-4172

RECEPTIONISTS needed for the Plymouth/Canton area. Must have previous experience. We offer long term and temp-to-perm assignments with excellent pay. ETO Temporary Services. An Equal Opportunity Employer.

RECEPTIONIST Bloomfield Hills firm seeks highly motivated pleasant individual to answer phone & general office. Please send resume to box 524

RECEPTIONIST Full time for paper & bag distribution. Must be able to direct multiple lines and perform general office functions. Send resume to Box 634

RECEPTIONIST Large property management company is seeking energetic individuals for entry level Secretarial positions. Must have experience with word processing and data entry.

RECEPTIONIST/CLERICAL - part-time Computer/office machine experience preferred. 2-3 days per week, midday hours. 455-6870

RECEPTIONIST/ASSISTANT for medical practice. M-F, 8am-5pm. Mon & Wed mornings. Thu & Fri afternoon. Call 354-0057

RECEPTIONIST Wanted part for Merle Norman in Troy. Experience preferred. Please call for interview. Box 524

504 Help Wanted Office-Clerical

RECEPTIONIST We are looking for a responsible individual with a pleasant speaking voice & telephone experience.

RECEPTIONIST/RECEPTIONIST Needed to work holidays/Troy/Amherst area. Must have experience in handling busy office.

ET Services & Systems 589-8428 SECRETARIES with word processing needed to work long short and temp-to-perm assignments.

SECRETARY - major magazine publishing company needs part time secretary - 3 days per week.

SECRETARY/RECEPTIONIST - immediate full time opening for bright person with excellent communication skills.

EXECUTIVE SECRETARY The Detroit offices of Ryder Distribution Resources, Inc. has an excellent opportunity for a Secretary with wide-ranging executive sales support skills.

Your challenges will include handling highly confidential information creating financial reports, and often anticipating the needs of senior level executives.

To succeed, you must have at least 3 years executive-level sales secretarial experience, and strong word processing skills.

SECRETARY/WORD PROCESSOR WordPerfect 5.1, Lotus 1-2-3, filing, travel arrangements, and phone work.

ET Services & Systems 589-8428 SECRETARY WORD PROCESSOR Several openings in Plymouth - Livonia Farmington, Troy.

ARBOR TEMPS 459-1166 SECRETARY/WRITER Requirements: 3 plus years experience, major computer skills.

SECRETARY for Livonia office. Part time Mon-Fri. Some computer knowledge helpful.

SECRETARY - for fast-paced Livonia law firm. Good typing skills essential. Entry level position.

SECRETARY Full or part time. Good typist. Computer experience preferred but not necessary.

SECRETARY - FULL TIME For computer software company. Enthusiastic, detail-oriented.

SECRETARY/GENERAL OFFICE - busy Farmington Hills CPA firm needs experienced person with strong computer/word processor skills.

INTERNATIONAL CORPORATION Outstanding opportunity in marketing/sales division. Top skills, 1 year experience.

SECRETARY/RECEPTIONIST Excellent phone, typing, & filing skills required. Canton location.

SECRETARY/RECEPTIONIST Part-time. Macintosh & telemarketing experience a plus. Birmingham home office.

SECRETARY (PART TIME) 3-4 days/wk. Must be flexible w/ hours. Call Lisa Broccardo.

SECRETARY/RECEPTIONIST Excellent phone, typing, & filing skills required. Canton location.

SECRETARY/RECEPTIONIST Part-time. Macintosh & telemarketing experience a plus. Birmingham home office.

SECRETARY (PART TIME) 3-4 days/wk. Must be flexible w/ hours. Call Lisa Broccardo.

SECRETARY/RECEPTIONIST Excellent phone, typing, & filing skills required. Canton location.

SECRETARY/RECEPTIONIST Part-time. Macintosh & telemarketing experience a plus. Birmingham home office.

SECRETARY (PART TIME) 3-4 days/wk. Must be flexible w/ hours. Call Lisa Broccardo.

SECRETARY/RECEPTIONIST Excellent phone, typing, & filing skills required. Canton location.

SECRETARY/RECEPTIONIST Part-time. Macintosh & telemarketing experience a plus. Birmingham home office.

SECRETARY (PART TIME) 3-4 days/wk. Must be flexible w/ hours. Call Lisa Broccardo.

504 Help Wanted Office-Clerical

SALES SECRETARY Part time. Excellent opportunity for a highly motivated individual with previous office experience.

SECRETARY I Require experienced, Word Perfect, dictaphone, Legal Terminology, excellent telephone etiquette.

SECRETARY I Require experienced, Word Perfect, dictaphone, Legal Terminology, excellent telephone etiquette.

SECRETARY I Require experienced, Word Perfect, dictaphone, Legal Terminology, excellent telephone etiquette.

SECRETARY I Require experienced, Word Perfect, dictaphone, Legal Terminology, excellent telephone etiquette.

SECRETARY I Require experienced, Word Perfect, dictaphone, Legal Terminology, excellent telephone etiquette.

SECRETARY I Require experienced, Word Perfect, dictaphone, Legal Terminology, excellent telephone etiquette.

SECRETARY I Require experienced, Word Perfect, dictaphone, Legal Terminology, excellent telephone etiquette.

SECRETARY I Require experienced, Word Perfect, dictaphone, Legal Terminology, excellent telephone etiquette.

SECRETARY I Require experienced, Word Perfect, dictaphone, Legal Terminology, excellent telephone etiquette.

SECRETARY I Require experienced, Word Perfect, dictaphone, Legal Terminology, excellent telephone etiquette.

SECRETARY I Require experienced, Word Perfect, dictaphone, Legal Terminology, excellent telephone etiquette.

SECRETARY I Require experienced, Word Perfect, dictaphone, Legal Terminology, excellent telephone etiquette.

SECRETARY I Require experienced, Word Perfect, dictaphone, Legal Terminology, excellent telephone etiquette.

SECRETARY I Require experienced, Word Perfect, dictaphone, Legal Terminology, excellent telephone etiquette.

SECRETARY I Require experienced, Word Perfect, dictaphone, Legal Terminology, excellent telephone etiquette.

SECRETARY I Require experienced, Word Perfect, dictaphone, Legal Terminology, excellent telephone etiquette.

SECRETARY I Require experienced, Word Perfect, dictaphone, Legal Terminology, excellent telephone etiquette.

SECRETARY I Require experienced, Word Perfect, dictaphone, Legal Terminology, excellent telephone etiquette.

SECRETARY I Require experienced, Word Perfect, dictaphone, Legal Terminology, excellent telephone etiquette.

SECRETARY I Require experienced, Word Perfect, dictaphone, Legal Terminology, excellent telephone etiquette.

SECRETARY I Require experienced, Word Perfect, dictaphone, Legal Terminology, excellent telephone etiquette.

SECRETARY I Require experienced, Word Perfect, dictaphone, Legal Terminology, excellent telephone etiquette.

SECRETARY I Require experienced, Word Perfect, dictaphone, Legal Terminology, excellent telephone etiquette.

SECRETARY I Require experienced, Word Perfect, dictaphone, Legal Terminology, excellent telephone etiquette.

SECRETARY I Require experienced, Word Perfect, dictaphone, Legal Terminology, excellent telephone etiquette.

SECRETARY I Require experienced, Word Perfect, dictaphone, Legal Terminology, excellent telephone etiquette.

SECRETARY I Require experienced, Word Perfect, dictaphone, Legal Terminology, excellent telephone etiquette.

SECRETARY I Require experienced, Word Perfect, dictaphone, Legal Terminology, excellent telephone etiquette.

505 Help Wanted Food-Beverage

Accepting applications for SEVERAL HOST/HOSTESS At the Grand Orchard, Farmington Hills.

Little Caesar's Italiano Openings. Accepting applications: Wait Staff, Food Prep Crew.

LOOKING FOR EXPERIENCED Line Cooks, Prep & Wait Staff. Competitive salary & benefits available.

MOUNTAIN JACKS FARMINGTON HILLS is now accepting applications for LUNCH & DINNER WAIT STAFF

OUR GROWING W Bloomfield restaurant is looking for a friendly outgoing person to greet our patrons.

PIZZA CHEF Drivers Prep Help & Cooks needed. Full or part time. Day & night shifts available.

BLAKENEY'S RANCH HOUSE NOW HIRING COOKS WAIT STAFF HOST/HOSTESS

DAY & EVENING Shifts both part & full time. Looking for outgoing people to work our busy restaurant.

BOB EVANS NOW HIRING WAITERS/WAITSTRESS Apply in person at 26248 Telegraph Mt. Troy

BOB EVANS RESTAURANTS Now accepting applications for experienced Line Cooks.

BUDDY'S WEST NOW HIRING SALAD PREP PIZZA COOKS Competitive wages and benefits.

BUS PERSONS & WAIT STAFF Full time. Apply in person after 3pm. Westland

CATERING MANAGER We require an individual with the education, business background, and motivation to assume hands on catering responsibilities.

Observer & Electronic Newspapers 36251 Schoolcraft Rd. Livonia MI 48150

Observer & Electronic Newspapers 36251 Schoolcraft Rd. Livonia MI 48150

Observer & Electronic Newspapers 36251 Schoolcraft Rd. Livonia MI 48150

Observer & Electronic Newspapers 36251 Schoolcraft Rd. Livonia MI 48150

Observer & Electronic Newspapers 36251 Schoolcraft Rd. Livonia MI 48150

Observer & Electronic Newspapers 36251 Schoolcraft Rd. Livonia MI 48150

Observer & Electronic Newspapers 36251 Schoolcraft Rd. Livonia MI 48150

Observer & Electronic Newspapers 36251 Schoolcraft Rd. Livonia MI 48150

Observer & Electronic Newspapers 36251 Schoolcraft Rd. Livonia MI 48150

Observer & Electronic Newspapers 36251 Schoolcraft Rd. Livonia MI 48150

Observer & Electronic Newspapers 36251 Schoolcraft Rd. Livonia MI 48150

Observer & Electronic Newspapers 36251 Schoolcraft Rd. Livonia MI 48150

Observer & Electronic Newspapers 36251 Schoolcraft Rd. Livonia MI 48150

Observer & Electronic Newspapers 36251 Schoolcraft Rd. Livonia MI 48150

Observer & Electronic Newspapers 36251 Schoolcraft Rd. Livonia MI 48150

Observer & Electronic Newspapers 36251 Schoolcraft Rd. Livonia MI 48150

Observer & Electronic Newspapers 36251 Schoolcraft Rd. Livonia MI 48150

505 Help Wanted Food-Beverage

Accepting applications for SEVERAL HOST/HOSTESS At the Grand Orchard, Farmington Hills.

Little Caesar's Italiano Openings. Accepting applications: Wait Staff, Food Prep Crew.

LOOKING FOR EXPERIENCED Line Cooks, Prep & Wait Staff. Competitive salary & benefits available.

MOUNTAIN JACKS FARMINGTON HILLS is now accepting applications for LUNCH & DINNER WAIT STAFF

OUR GROWING W Bloomfield restaurant is looking for a friendly outgoing person to greet our patrons.

PIZZA CHEF Drivers Prep Help & Cooks needed. Full or part time. Day & night shifts available.

BLAKENEY'S RANCH HOUSE NOW HIRING COOKS WAIT STAFF HOST/HOSTESS

DAY & EVENING Shifts both part & full time. Looking for outgoing people to work our busy restaurant.

BOB EVANS NOW HIRING WAITERS/WAITSTRESS Apply in person at 26248 Telegraph Mt. Troy

BOB EVANS RESTAURANTS Now accepting applications for experienced Line Cooks.

BUDDY'S WEST NOW HIRING SALAD PREP PIZZA COOKS Competitive wages and benefits.

BUS PERSONS & WAIT STAFF Full time. Apply in person after 3pm. Westland

CATERING MANAGER We require an individual with the education, business background, and motivation to assume hands on catering responsibilities.

Observer & Electronic Newspapers 36251 Schoolcraft Rd. Livonia MI 48150

Observer & Electronic Newspapers 36251 Schoolcraft Rd. Livonia MI 48150

Observer & Electronic Newspapers 36251 Schoolcraft Rd. Livonia MI 48150

Observer & Electronic Newspapers 36251 Schoolcraft Rd. Livonia MI 48150

Observer & Electronic Newspapers 36251 Schoolcraft Rd. Livonia MI 48150

Observer & Electronic Newspapers 36251 Schoolcraft Rd. Livonia MI 48150

Observer & Electronic Newspapers 36251 Schoolcraft Rd. Livonia MI 48150

Observer & Electronic Newspapers 36251 Schoolcraft Rd. Livonia MI 48150

Observer & Electronic Newspapers 36251 Schoolcraft Rd. Livonia MI 48150

Observer & Electronic Newspapers 36251 Schoolcraft Rd. Livonia MI 48150

Observer & Electronic Newspapers 36251 Schoolcraft Rd. Livonia MI 48150

Observer & Electronic Newspapers 36251 Schoolcraft Rd. Livonia MI 48150

Observer & Electronic Newspapers 36251 Schoolcraft Rd. Livonia MI 48150

Observer & Electronic Newspapers 36251 Schoolcraft Rd. Livonia MI 48150

Observer & Electronic Newspapers 36251 Schoolcraft Rd. Livonia MI 48150

Observer & Electronic Newspapers 36251 Schoolcraft Rd. Livonia MI 48150

Observer & Electronic Newspapers 36251 Schoolcraft Rd. Livonia MI 48150

506 Help Wanted Sales

A CAREER SHOULD BE BY DESIGN. NOT BY DEFAULT. Aggressive, outgoing individual needed for specialty retail organization.

ATTENTION HIGH SCHOOL & COLLEGE STUDENTS Looking for a comfortable working environment? We guarantee \$5 to start & up to \$12 in possible commission.

ACCOUNT EXECUTIVE SALES Career opportunity with Southeastern Michigan's largest AT&T VAR, and the nation's largest medical/optical/dental insurance, car allowance, and expense reimbursement.

ADMISSIONS ADVISOR/TALENT SCOUT for John Casablanca's Modeling & Career center. Attractive, vivacious person with a proven track record.

AGGRESSIVE CAREER ORIENTED person wanted. Tru Green Chem Lawn, the nationwide leader in the green industry is seeking competent self motivated individuals.

A GREAT PLACE TO WORK AND A \$25,000 DOLLAR MINIMUM ANNUAL SALARY. IS WHAT WE CAN OFFER TO THE AMBITIOUS, CONSCIENTIOUS, AND SELF MOTIVATED.

A NEW CHANCE AT SUCCESS BINARY MANAGER. This is your opportunity to discover the unlimited professional & financial rewards of a career with Eastern Michigan University.

ARE YOU LOOKING FOR A CHANGE? I love my new job. My old job was never like this. The work is fast paced and challenging.

AMERICAN BUSINESS EXPANDING! Looking for people with contacts in Mexico, Brazil, or Argentina. Lucrative 16%/hr. information line.

BEVERLY HILLS RACKET & HEALTH CLUB. Birmingham has immediate openings for full and part time sales people. Earn \$25,000.

CAREER IN REAL ESTATE SALES WITH US IS A "REAL JOB". Our programs and support systems are so effective we guarantee you a minimum annual income of \$25,000.

ART VAN FURNITURE WESTLAND MR THOMAS NOVI 425-9600 MR DONOVAN LIVONIA 348-8922 MR FERGUSON LIVONIA 478-8870

ARE YOU WORTH MORE? Are you fashion oriented, great with people, and worth more than you're presently making?

RESTAURANT Opening. Executive Chef. Sous Chef & Management positions available. Send resume to: 45033 W. Pontiac Tr. Novi MI 48077

SOUTHFIELD DELI needs food prep, cook, and delivery. Part time, no evenings or weekends. Experience preferred but not necessary.

STATION 885 NOW HIRING Experienced Line Cooks & Hosts/Hostesses. Day or night shift, full or part time. Apply within 2-5pm. 7 days a week.

WAIT STAFF BAR SERVERS & BUS PERSONS Days/Nights Full & part time. Apply in person. Final Approach. 350 E 14 Mile. Madison Hts

WAITSTAFF Day & evenings shift. Must be flexible. Apply in person. Dimitri's 501 S Wayne Rd. No phone calls please.

WAITSTAFF Franke's of Garden City needs full or part time night waitstaff. Call Tuesday or Friday between 12 & 3. 421-2424

WAIT STAFF HOST PERSON DAY/BARTENDER Apply in person 2-5pm. Mr B's Bloomfield, 6480 Orchard Lake Rd. 855-3110

WENDY'S IS NOW HIRING Get the best in the business. Compare ours to all others. Join America's quality restaurant team.

4-Four Commission Plans - Referrals/Relocation - Best Buyer/Best Seller Systems - Accredited Training

506 Help Wanted Sales

HOME FINISHING MATERIAL Store sales full time SALES PERSON. Duties will include sales, invoicing, inventory control, etc. Flexible hrs., excellent working conditions. Immediate Rochester 651-0842

IMMEDIATE FULL TIME opening retail lighting showroom in Livonia. 4 day work week. Typing & clerical experience necessary. Benefits: Blue Cross, life insurance & vacation. Call: 421-9905

INDUSTRIAL DISTRIBUTOR of graphic press materials located in Birmingham is seeking to expand sales base. Initial position is part-time, (25-30 hrs/week) with opportunity to expand to full time during next 12 months. Job responsibilities include development of new accounts via telephone, quotations, & account management. Would prefer past sales experience in industrial distribution. This is a salaried position with commission incentive. Reply to Box #92

Observer & Eccentric Newspapers 36251 Schoolcraft Rd. Livonia MI 48150

This employer restricts smoking an Equal Opportunity Employer

INDUSTRIAL TOOL SALES Are you seeking to work 7-2 positions available for aggressive hard working individuals. Cutting tool knowledge a plus, but we are willing to train if you have the right attitude & any plus commission. 532-1515

INSIDE SALES INDUSTRIAL DISTRIBUTOR LOOKING FOR person with inside sales experience. Please reply in confidence to P.O. Box 60583, Rochester, MI 48308

INSIDE SALES MEDICAL/PHARMACEUTICAL

• Great opportunity for a good communicator with a selling attitude. • Call on existing & develop new physicians accounts. • Medical &/or sales background preferred

Several openings available. For immediate consideration, send resume to:

HARVARD DRUG GROUP P.O. Box 51640, Livonia, MI 48151 or call & leave message at 1-800-875-0123 ext 260

INSURANCE - LIFE Casualty agency desires to start a life health & group general agency as a separate subsidiary. We have an unusual opportunity as an assistant general agent, to create and manage this operation. Applicant can be male or female. Must be a self-starter with a high degree of initiative, energy and drive. Currently licensed and active, with a successful track record. Min. of 5 yrs. experience. Non-smoking office. Send resume to Box 668

Observer & Eccentric Newspapers 36251 Schoolcraft Rd. Livonia MI 48150

IS YOUR JOB helping make your dreams come true? Chart your future with international marketing company. Call 456-7658

JEWELRY SALES Full time part time fine jewelry. GJ preferred. Experience mandatory. Southfield area. Send resume to: Box 556 Newspapers 36251 Schoolcraft Rd. Livonia MI 48150

MALL DEMONSTRATORS Salary and/or commission for Christmas season. Please call 333-1300

MANAGEMENT/SALES International company needs male/female who has owned or managed a business in management, marketing, sales, & public speaking necessary. Must have integrity & strong self-motivation. Send resume to Marketing Director, 300 Wilshire Blvd., Ste 203, Troy, MI 48064.

MANAGERS/TRAINEE Large international corporation looking for an aggressive individual with ambition to earn \$30,000 per year & more. Willing to start at bottom & learn new business. Opportunity for \$300 a week while learning. Call 525-6285

MARKETING Leader in residential home sales seeks a qualified Sales Person to train for a Real Estate Sales position now open in our office at Six Mile Rd. and Haggerty Rd. We will teach you through our S.P.S. training program. To arrange an interview call: MR STEVE HOCKING

CENTURY 21 Hartford South 464-6400

Marketing Trainee Local office of a national organization needs a good few people, willing to work hard and be trained. GUARANTEED \$25,000 first year income. Call Lisa Dumsa at 356-7111

NATIONAL FINANCIAL PRODUCTS marketing company seeking career oriented individuals with leadership ability & the desire to quickly accept major responsibility. Send resume in confidence to P.O. Box 80101, Rochester, MI 48308-0101

NATIONAL LEASING company seeks vehicle sales representative. Light to medium duty truck sales and/or finance experience preferred. Duties will include vehicle sales/leasing and direct marketing. Excellent base pay and commission package, and pleasant work environment. Please send resume to: D.S., P.O. Box 8066, Farmington Hills, MI 48333-9066

NOW HIRING Individuals to fill positions in new company. Call Charlene for details, at 953-1173

OFFICE EQUIPMENT Representative - outside sales, leads & closes. Call Mr. Spitz at 356-2000

RED WING TICKET WINNERS

Adam Harris 21622 Lundy Farmington Hills 48336

Thomas Supanick 29700 Pickford Livonia 48152

Marcos Guerra 9034 Hib Rd. Livonia 48150

Jamie Priekorn 7316 Arie Rd. Northville 48167

Please call the promotion department of the Observer & Eccentric before 4 p.m. Friday, to claim your free tickets.

591-2300, ext. 2153

Congratulations!

506 Help Wanted Sales

METALS SALES PERSON Titanium & high temperature metals warehouse doing world-wide business for over 30 years needs inside sales person. Alky MI 48173 313 853-9191

MORTGAGE ORIGINATORS Fast growing mortgage corporation is looking for both experienced and inexperienced originators. Aggressive compensation plan, Blue Cross, and performance based bonus. Citizens Mortgage Corporation, 2824 Franklin Rd., Southfield, MI 48034. Call 352-1200

Office Furniture SALES Michigan's most progressive office products dealer needs aggressive people to sell furniture in its retail furniture showrooms. The right candidate will be responsible for the entire furniture area including prospecting and developing account base, maintaining adequate stock and professionally displaying merchandise. Salary plus commission with expected earnings of \$15,000-\$18,000. Medical/dental. We have many Metro Detroit locations to place you in. Send resume to: Macalester Office Products 15188 W. 8 Mile Rd. Oak Park, MI 48237 Attention: Fred Mekdon

SALES ENGINEER A growing construction & special waste handling equipment needs an aggressive person to join our winning team representing our company in sales. Candidate must have a minimum of 2 years sales experience, preferably in some mechanical area. Position consists of traveling throughout the state 50% of the time. Starting salary mid \$20's, car & benefits. Qualified individuals interested in this exciting position should send their resume to: Observer & Eccentric Newspapers 36251 Schoolcraft Rd. Livonia MI 48150

SALES LEADERSHIP! New Company! New Concept! Seeking sales people with proven background. \$600 plus 1st yr. potential 313-3477

SALES PEOPLE FOR THE '90's Positive attitudes result in profitable sales. The best sales people are putting their sales staff to rest. We are willing to fully train new agents. For the new and experienced agent, our program will create a steady stream of sales and money that you have never seen. Families are calling us to sell their homes. So, stop in to see what this winning team can do for you. Call for a confidential interview today!

WOLVERINE PROPERTIES 532-0600

SALES PEOPLE needed, outside and local. Must be organized, self-motivated and enthusiastic. Flexible hours allow you to be your own boss. Must produce. Resume to: Box 678, Observer & Eccentric Newspapers 36251 Schoolcraft Rd. Livonia MI 48150

REAL ESTATE CAREER AMBITIOUS? CONSCIENTIOUS? WE WANT YOU!! We will train you and start you on long term, high income career. Call John Beattie, Livonia REAL ESTATE ONE 261-0700

REAL ESTATE CLASSES Learn how to obtain your Michigan Real Estate license. Our classes are taught by experienced professionals. State of the art facility, Day and PM classes available. \$125 includes 2 hours of instruction and all during business hours. 1-800-989-2121

REAL ESTATE PROFESSIONALS The old days and ways are no more! Just getting a license is not enough to insure success. If you are willing to work hard, no other company can offer a better package to help you attain a successful career in real estate.

• Individualized training • 100% commission plan • Complete training office and technical systems • Group health coverage • Buy and sell your system • #1 rated franchise system • Unsurpassed national and local advertising exposure

Call Jim Stevens or Neal Lamphere, 459-6000 for personal interview

459-6000

COLDWELL BANKER Schweitzer Real Estate

REAL ESTATE SALES WEST BLOOMFIELD \$25,000 guaranteed income program combined with excellent training. Call for phone interview. Fran Mirsky, 851-6000

REAL ESTATE SALES \$25,000 guaranteed income program. We are a top 50 distributor as listed in Chemical Processing with manufacturing and engineering value added capabilities. Growth oriented. We have doubted company's sales in past 5 years.

RECRUITER National personnel agency. Salary, commissions, bonuses, training, high income potential, full benefits. Sales experience preferred. Call 464-1836 BRYAN BUREAU RECRUITERS

ROUTE SALES REP - \$35K Resume to Personnel Dept. Agency, 1607 E. Big Beaver, Troy, MI 48063 or call 524-1500

LOOKING FOR highly motivated jewelry salesperson. No experience necessary. Will train. Full or part-time. Ask for Vito or Koko 968-3060

SALES ENGINEER - HVAC-ecommunication control systems, minimum 2 yrs. experience. BSME/EE or equivalent experience. dramatic expansion mode, including international markets. Excellent career path to achieve salary/profit sharing commensurate with capability. Resume to: John T. Harney, Control Pack Corp., 23840 Industrial Park Dr., Farmington Hills, MI 48335.

SALES LEASING Immediate opening for sales rep with equipment leasing experience to market in metro area. Top commission paid, draw plus commission. For interview call Commercial First Leasing, Inc. 313-731-2699

SALES - NEW CAREER 1992 \$700-\$2000/WK National music company seeks goal oriented people to handle local retail/fund raising accounts with music & video products. Weekly re-order bonuses. Rapid advancement. Call immediately. 818-783-8347 or local 222-1505

OHIO GEAR/RICHMOND GEAR P.O. Box 238 Liberty, SC 29657 Attn: Personnel Manager

TELEMARKETING Call Today! Start Tomorrow! Cash Paid Weekly

TELEMARKETING - Immediate openings. Hourly + bonus. 9:30am-2:30pm. 10-40 hrs/week. Call: 478-2784

TRAVEL SALES AGENT For Michigan's largest tour operator

WE ARE JOINING our reservation sales agents who are up-beat, articulate, & easily understood on the telephone. Computer experience & travel education are a plus. We will train on our program.

Apply in person only! Tues, Wed, Thurs, Fri. between 10-12 noon & 2-5pm

HMHF TRAVEL CORP 29566 Northwestern Hwy. Southfield, MI

\$5 DAILY CASH \$5

Our company is the fastest growing meat company in the Midwest. You will be working in a fast paced environment. Monthly prizes, trips, weekly bonus check & management opportunity. (313) 623-2600 (313) 234-4004

\$5-\$20 PER HOUR. Good position for income credit card promotion in major 12 Oaks & Summit Place department stores. Flexible hrs. Call & references. 1-800-802-3302

506 Help Wanted Sales

SALE PERSON NEEDED Home improvement experience required. Gas mileage allowance. Call Charles for interview. 443-5300

SALES ASSISTANT For auto dealership. Seeking professional 30's-40's. Must have Hines Park Lincoln Mercury 40601 Ann Arbor Rd. Plymouth MI 48173 Attn: Erica Prince

SALES Energetic self-starter & organized. East Michigan industrial accounts & construction trades. Benefits include: auto, health insurance, tremendous opportunity. Send resume to box 688, Observer & Eccentric Newspapers 36251 Schoolcraft Rd. Livonia MI 48150

SALES ENGINEER A growing construction & special waste handling equipment needs an aggressive person to join our winning team representing our company in sales. Candidate must have a minimum of 2 years sales experience, preferably in some mechanical area. Position consists of traveling throughout the state 50% of the time. Starting salary mid \$20's, car & benefits. Qualified individuals interested in this exciting position should send their resume to: Observer & Eccentric Newspapers 36251 Schoolcraft Rd. Livonia MI 48150

SALES LEADERSHIP! New Company! New Concept! Seeking sales people with proven background. \$600 plus 1st yr. potential 313-3477

SALES PEOPLE FOR THE '90's Positive attitudes result in profitable sales. The best sales people are putting their sales staff to rest. We are willing to fully train new agents. For the new and experienced agent, our program will create a steady stream of sales and money that you have never seen. Families are calling us to sell their homes. So, stop in to see what this winning team can do for you. Call for a confidential interview today!

WOLVERINE PROPERTIES 532-0600

SALES PEOPLE needed, outside and local. Must be organized, self-motivated and enthusiastic. Flexible hours allow you to be your own boss. Must produce. Resume to: Box 678, Observer & Eccentric Newspapers 36251 Schoolcraft Rd. Livonia MI 48150

REAL ESTATE CAREER AMBITIOUS? CONSCIENTIOUS? WE WANT YOU!! We will train you and start you on long term, high income career. Call John Beattie, Livonia REAL ESTATE ONE 261-0700

REAL ESTATE CLASSES Learn how to obtain your Michigan Real Estate license. Our classes are taught by experienced professionals. State of the art facility, Day and PM classes available. \$125 includes 2 hours of instruction and all during business hours. 1-800-989-2121

REAL ESTATE PROFESSIONALS The old days and ways are no more! Just getting a license is not enough to insure success. If you are willing to work hard, no other company can offer a better package to help you attain a successful career in real estate.

• Individualized training • 100% commission plan • Complete training office and technical systems • Group health coverage • Buy and sell your system • #1 rated franchise system • Unsurpassed national and local advertising exposure

Call Jim Stevens or Neal Lamphere, 459-6000 for personal interview

459-6000

COLDWELL BANKER Schweitzer Real Estate

REAL ESTATE SALES WEST BLOOMFIELD \$25,000 guaranteed income program combined with excellent training. Call for phone interview. Fran Mirsky, 851-6000

REAL ESTATE SALES \$25,000 guaranteed income program. We are a top 50 distributor as listed in Chemical Processing with manufacturing and engineering value added capabilities. Growth oriented. We have doubted company's sales in past 5 years.

RECRUITER National personnel agency. Salary, commissions, bonuses, training, high income potential, full benefits. Sales experience preferred. Call 464-1836 BRYAN BUREAU RECRUITERS

ROUTE SALES REP - \$35K Resume to Personnel Dept. Agency, 1607 E. Big Beaver, Troy, MI 48063 or call 524-1500

LOOKING FOR highly motivated jewelry salesperson. No experience necessary. Will train. Full or part-time. Ask for Vito or Koko 968-3060

SALES ENGINEER - HVAC-ecommunication control systems, minimum 2 yrs. experience. BSME/EE or equivalent experience. dramatic expansion mode, including international markets. Excellent career path to achieve salary/profit sharing commensurate with capability. Resume to: John T. Harney, Control Pack Corp., 23840 Industrial Park Dr., Farmington Hills, MI 48335.

SALES LEASING Immediate opening for sales rep with equipment leasing experience to market in metro area. Top commission paid, draw plus commission. For interview call Commercial First Leasing, Inc. 313-731-2699

SALES - NEW CAREER 1992 \$700-\$2000/WK National music company seeks goal oriented people to handle local retail/fund raising accounts with music & video products. Weekly re-order bonuses. Rapid advancement. Call immediately. 818-783-8347 or local 222-1505

OHIO GEAR/RICHMOND GEAR P.O. Box 238 Liberty, SC 29657 Attn: Personnel Manager

TELEMARKETING Call Today! Start Tomorrow! Cash Paid Weekly

TELEMARKETING - Immediate openings. Hourly + bonus. 9:30am-2:30pm. 10-40 hrs/week. Call: 478-2784

TRAVEL SALES AGENT For Michigan's largest tour operator

WE ARE JOINING our reservation sales agents who are up-beat, articulate, & easily understood on the telephone. Computer experience & travel education are a plus. We will train on our program.

Apply in person only! Tues, Wed, Thurs, Fri. between 10-12 noon & 2-5pm

HMHF TRAVEL CORP 29566 Northwestern Hwy. Southfield, MI

\$5 DAILY CASH \$5

Our company is the fastest growing meat company in the Midwest. You will be working in a fast paced environment. Monthly prizes, trips, weekly bonus check & management opportunity. (313) 623-2600 (313) 234-4004

\$5-\$20 PER HOUR. Good position for income credit card promotion in major 12 Oaks & Summit Place department stores. Flexible hrs. Call & references. 1-800-802-3302

506 Help Wanted Sales

SELL WOOD furniture & custom finishing. A high level of enthusiasm can mean high income. We're looking for energetic individuals to sell our finest furniture. Apply at: 1038 N. Woodward, Royal Oak.

EXPERIENCED TELEMARKETERS OLSTEN is looking for dynamic, energetic individuals to sell cultural entertainment packages. Excellent phone skills & pleasant demeanor essential. Immediate openings in Southfield area. Day & evening shifts available. Call for personal interview.

OLSTEN Temporary Services Southfield 354-0555

TELEMARKETERS Professional sales people wanted to sell MET A717, and Onco Ball products. Experience preferred. Call: 489-0350

TERRITORY MANAGER Despite the Doom & Gloomers, we're growing into the '90's. If you are interested in participating in the most exciting business opportunity of the 90's, you have at least 3 yrs. of sales experience, read further. MRM Air Products is a professional, fast growing, leading top of the line products and the fluid power industry. We are looking for a person with a college degree or PHS Certified in auditing, knowledge of Pneumatics or Hydraulic and a familiarity with the automotive market are preferred. If you meet the above minimum requirements, send resume or call MRM AIR PRODUCTS: PO Box 354, Novi, MI 48376-0354 Attention: David Nichols CALL 348-6900

TREMENDOUS POTENTIAL for an independent rep to distribute creative environmental products. Excellent training, commission, and support. Earthbound, 30500 Telegraph, Ste 2161, Birmingham 48025

100 PEOPLE - to lose weight now. No prep needed. 100% natural. 100% guaranteed. Just started. New. 303-979-9292

507 Help Wanted Part Time ACCOUNTING Firm Seeking part time telemarketer. Should have good phone voice and manner. Experience helpful, but not necessary. Call: 442-4880

AFTER CHRISTMAS Employment. RGIS inventory is now hiring permanent part-time sales representatives. Applicant must be available to work days, nights & weekends. No experience necessary. Paid training. Good benefits. Start \$6/hr. No 489-8535

BOOKKEEPER - EXPERIENCED Full-Charge Bookkeeper needed, 20 hours per week for food service company. Hourly rate negotiable. Qualified parties call for an interview. 645-1700

CASHIER Afternoons & weekends. Apply in person. Mathison Hardware, 31535 Ford Rd. Garden City, MI 48135

CORPORATE TELEMARKETER for major real estate company. Experienced, confident, outgoing professional. Part time. Attractive compensation. Carolyn, 953-2900 Ext. 21

DANCE INSTRUCTOR Work Saturday mornings. Must be 18 yrs. or older with prior experience as dance instructor (Ballet, Jazz, Tap, etc.). Must be able to teach and motivate. Good benefits. Send resume to: Artin; Rebecca, 2312 Monroe St., Dearborn, MI 48124

HELPER PART-TIME: For Industrial Laundry equipment service company in Westland. Call: 313-722-1211

JANITORIAL - PART TIME Available immediately. Clean private school. Experience needed. Call Matt, 8am-12 noon, Mon thru Fri. 466-8900

MARKET RESEARCH Ideal for homemakers. Must be sharp, detail oriented. Conduct weekly scanner grocery audit of product placement in northwestern suburban area. No experience needed. Send letter of interest to: Attn: Rebecca, 2312 Monroe St., Dearborn, MI 48124

NIGHT WATCHMAN (M/F) - Mature person. \$100 per week. Payout \$100 per weekend. W/MTWAM. 466-6260

OFFICE ASSISTANT Part time, flexible hours for custom furniture manufacturer. Interesting work. Excellent benefits. Accepting applications between 10-4. Entry level. 422-3890

OFFICE CLEANING - Part time. Immediate \$5.50 to start. 1 1/2 hours a week. Monday-Friday. Good schedule. Call 1pm-3pm. 981-4909

BANK TELLER WANTED At Credit Union. 15-20 hours per week. \$8.00 per hour. Must have experience. Apply in person for interview on 11/23 or 11/30 at 23400 Plymouth Rd., near Telegraph in Dearborn, MI. between 8:30am-8:30pm.

WED. TUE. clerical position, 10-4 Wed. & Thurs. Daily entry experience preferred. Apply in person at The Heatherwood, 22800 Civic Center, Southfield, MI 48034

PART-TIME SALES REP: Needed to call on local chain. In Downriver Area. Hourly wage plus mileage. Please send resume: 29810 Harper, St. Clair Shores, MI 48082

PART-TIME - \$8 per hour. Permanent position. 12 Oaks Mall. No selling, will train. People skills required. Ask for Ann. 543-4500

PERMANENT, PART TIME Morning position. Hours: 8 or 8:30 to 12 noon. Mature, responsible person. Assist in office with phones, word processing, and other misc. office duties. Southfield Town Center location. Resume to: Box 694

Observer & Eccentric Newspapers 36251 Schoolcraft Rd. Livonia MI 48150

SALES CLERK For evenings & weekends. Apply in person. 12 Oaks Mall. Farmington Rd. at 9 Mile.

SR. NUTRITION PROGRAM SUBSTITUTES - to 4 hrs/week. Various nutrition sites. 3 - 4 hrs/week. As needed. Must like working with seniors. Call: 326-4444

TELEMARKETING See ad under telemarketing in the General section or call from 5:30 - 8:30 pm. Livonia 421-7435

VETERINARY Hospital Opening for Doctor's assistant 18 or over. Mon thru Fri. 5pm-8pm. Sat. 8am-5pm. After 2pm call 349-8505

508 Help Wanted Domestic AFFECTIONATE CAREGIVER needed full time for sweet 9 month old in our Rochester Hills home. Good pay and working conditions. 442-7089

BABYSITTER - experienced. Mon thru Fri. 8am-5:30pm, non-smoker, 2 yrs. exp. \$10/hr. Call: 355-2917

BABYSITTER NEEDED, my Garden City home. Afternoons plus evenings. Children - 13, 9 & 7, 15-20 hrs./wk. References needed. 522-2298

BABYSITTER NEEDED - 2-3 days a week. 10-4 hrs/week. \$10/hr. 22 mos. in my W. Bloomfield home. 855-8923

BABYSITTER needed for 2 children in our Sterling Hills home. Full time. Non-smoker. Experience & references. 268-5622

DAYCARE needed in Plymouth home. Must have experience. 2 young boys, 3 days per week/25 hrs. 8am-5pm. Call: 454-0501

EXPERIENCED INFANT CARE needed in our Rochester home, part time - Fri. 12:30-3:00pm. Non-smoker. Own transportation & references required. 656-1977

WELL KNOWN Professional woman looking for a house "Manager". Position requires ability to work independently. Must be organized, energetic, and a team player. Send resume and references to: Box 854

Observer & Eccentric Newspapers 36251 Schoolcraft Rd. Livonia MI 48150

HOUSEKEEPER - reliable, experienced cleaning person needed for busy W. Bloomfield executive. Must be non-smoker, able to do laundry, cleaning & available for live-in 2 nights a week. References required. Call Heather at: 313-553-8555

HOUSEKEEPER - \$8 per hr. Mon & Fri. Clean house & cook dinner. 2 male adults. 10 Mile/Greenfield area. References. 967-4110

INFANT CARE. Experience, references 3 days/wk, 7:30-9pm. Excellent benefits. Monday-Friday. Call: 481-1511

LIVE-IN HOUSEKEEPER/Helper, for 84 yr. old invalid man, Birmingham. Free room & board plus wage. Call son at 398-9277, 8:30am. Mon-Sat.

LOOKING FOR A Special Someone to watch my 2 children on part time weekdays in my home. Must be a mother with a job. Call after 6pm. 347-7479

LOVING Nanny-housekeeper wanted for busy home in Farmington Hills. 3-5 days, live-in, non smoker preferred. References. 264-0991

MARY POPPINS - Immediate opening for part-time Nanny, 2 young preschoolers, in my home. Must be experienced. References. 522-5086

506 Help Wanted Domestic

AFTER SCHOOL care for 3 children in our Farmington Hills home. Good pay. Released afterwards. Must be over 14 or adult. Your child is welcome. Call Julie. 461-0399

BABYSITTER - Mon, Tues & Weds afternoons after school. Hours vary 2 elementary school age children. Own transportation, immediate. 13 mile & Farmington Rd. 461-0399

BABYSITTER/NANNY Flexible hours. Southfield area. Please call: 353-7287 Or, 569-7313

BABYSITTER NEEDED for infant and 10 year old in my LeVing Village home. Morning & evening hours. 352-4085

BABYSITTER WANTED - in N. Troy. College age or older with own car for 2-3 days per week, 5:30 to 8:30pm and occasional overnight. 3 times per month for 2 children 5 & 8. Call Cathy after 5pm. 828-0144

BABYSITTER WANTED Days. Your home or ours. Canton area. 1 Infant & 2 school-age kids. 981-5236

BLOOMFIELD Hills, experienced loving Nanny for 3 & 7 yr. olds. 5 days, live in, Tues, thru Sat. Non smoker, must drive, references required, good wages. 626-9577

CAREGIVER NEEDED immediately for 2 delightful boys, age 5 & 6. Non-Fri. 11:30-5pm. Housekeeping, cooking, baking, fun & games. Troy area. References required. 689-0553

CHILD CARE NEEDED for infant & 6 yr. old boy. Non-F



AUTOMOTIVE



823 Vans
 CHRYSLER 1992 Town & Country - All wheel drive, Factory official, mini condenser, 7 yr warranty. Was \$27,056. Now \$20,995.
 Livonia Chrysler-Plymouth 525-7604
CONVERSION 1986 VAN - Full size, automatic, air, power windows, power locks, 181, cruise, only \$8,888.
MATICK CHEVY 531-7100
DODGE 1985 CARAVAN LE - excellent condition, loaded, \$2995. After 5pm. 879-0762
DODGE 1986 Caravan LE 2.6 liter, clean, loaded, 7 passenger, new tires, brakes, radiator, 65,000 miles \$5350. Troy. 680-1981
DODGE 1987 Caravan LE - loaded, cream/wood grain, tan interior, excellent condition, see to believe, very miles, \$6500/offer. 477-8707
DODGE 1987 Caravan LE - excellent condition, 7 passenger, loaded, \$4500, days 591-1518. 728-0556
DODGE 1988 CARAVAN - 7 passenger, loaded, \$5995
DICK SCOTT Garden City 522-7820
DODGE 1989 B-150 Cargo Van, automatic, ready for work, only 45,000 miles \$5988
Dick Scott Dodge
 684 Ann Arbor Rd.
 451-2110 USED CARS 962-3322
DODGE 1991 B-350, 15 passenger, dual air, 9,000 miles, \$17,811
TOWN & COUNTRY
 474-6750 DODGE 474-6668
FORD 1979 VAN - 1 owner, 72,000 original miles, 4 speed, stored winters, excellent condition, \$4,000. 471-2066

823 Vans
 DODGE 1988-1989-1990-1992 Caravans & Grand Caravans! Starting at \$6993.
TOWN & COUNTRY
 474-6750 DODGE 474-6668
DODGE 1992 - 8250 conversion van, loaded & upgraded, \$24,000 new on May 1st, \$17,800. 459-6729
FORD ECONOLINE, 1989 Conversion - beautiful & clean interior & exterior. Loaded, \$9500. 455-4223
FORD E-150 1985 & 1986 cargo vans, 6 cylinder, \$1,950. V8, \$4850. 255-0054
FORD-1985 Conversion Van Oak trim, fully loaded, automatic, air. Must see. \$1,875. 525-6373
FORD 1987 AEROSTAR XLT - loaded, all the seats, priced to sell, extra ready! \$795
DICK SCOTT Garden City 522-7820
FORD 1988 E-150 Starcraft Conversion, quad chairs, seat, bed, lots more. \$9,495
PAT MILLIKEN FORD 255-3100
FORD 1990 AEROSTAR - low miles, with all the toys. \$995
GORDON CHEVROLET 458-5290
FORD, 1992-91, Super Cargo Vans, automatic, air, V8, extended, ready to work, from \$12,500.
DEMME FORD 721-2600
GMC 1986 Vandura Starcraft Conversion, Good condition. New tires. \$2,950. After 5pm 654-3699
PLYMOUTH VOYAGER 1991 - 6 cylinder, automatic, air, must sell! \$12,990
BILL FOX CHEVROLET 651-2262

823 Vans
 GMC 1990 RALLY STX - loaded, low miles, new air & heat, trailer package, excellent, \$12,900. 422-4233
PLYMOUTH 1985 Voyager, excellent, new brakes/tires, 107,000 mi, silver grey, no rust, \$2900. 626-3801
PLYMOUTH 1988 Voyager LX - loaded, V6, excellent condition, \$8250/best. After 5pm. 642-7375
PLYMOUTH 1988 - Grand Voyager SE, V6, automatic, air, sunscreen, 1 owner, low, low miles, \$6988.
Dick Scott Dodge
 684 Ann Arbor Rd.
 451-2110 USED CARS 962-3322
PLYMOUTH 1989 VOYAGER - automatic, air, much more, limited warranty included \$5995.
LES STANFORD CHEVROLET-GE0 565-6000
PLYMOUTH 1990 VOYAGER LE - V-6, 7 passenger, all the toys, 3 to choose, from \$9,995. 437-7144
PLYMOUTH 1991 VOYAGER - V6, 7 passenger, air, tilt, cruise, power locks, 1 owner, \$11,995.
 Livonia Chrysler-Plymouth 525-7604
PLYMOUTH 1991 VOYAGER - V6, 7 passenger, air, tilt, cruise, power locks, 1 owner, \$11,995.
 Livonia Chrysler-Plymouth 525-7604
PLYMOUTH 1992 VOYAGER - V6, 7 passenger, air, tilt, cruise, locks, Showroom new, \$13,995.
 Livonia Chrysler-Plymouth 525-7604
VOYAGER 1989 - V6, black cherry wood grain, over loaded, excellent condition, must see to appreciate. Must sell, \$8,750. 425-5973

823 Vans
 VOYAGER LE 1990 - automatic, air, 7 passenger, power seats, loaded, like new, \$9788
CAMPBELL
 Dodge 538-1500
SAFARI 1991, EXT, V6, automatic, air, rear heat, family run, \$14,288. Only \$8885.
MATICK CHEVY 531-7100
VOYAGER SE 1987 - automatic, air, 7 passenger, loaded, \$5995
CAMPBELL
 Dodge 538-1500
VOYAGER 1985- minivan, 5 passenger, 4 cylinder, 5 door, needs minor repair, \$3000/best. 476-5266
824 Jeeps & Other 4-Wheel Drives
BLAZER-1984 Full size, 305 V8, automatic, well maintained, runs great, \$3,800. 437-7144
BLAZER 1986, \$10, 4x4, loaded sunroof, 5 speed, highway mi, good condition, \$4200/best. 887-1832
BLAZER 1989, full size, loaded, \$11,200/best. 261-9096
BLAZER 1991, \$10; Tahoe, 4.3 V8, automatic, w/ 4x4, loaded, \$11,900. MATICK CHEVY 531-7100
BRONCO II, 1987 xlt - 2-tone red/white, manual transmission, full power, \$6500/best. 462-0596
CHEROKEE 1989 Sport, black 2 door, 4x4, 55,000 mi., \$11,000. Great shape. Mike, 455-5544
CHEROKEE-1991 Limited, white, fully loaded, 34,000 miles. 335-2115 \$18,500.
CHEVY 1988 K-15 4x4, 5.7L, fully loaded, tool box, cruise control, bedliner, am/fm cassette, air, power windows & door locks, tilt, runs & looks great. Must sell, \$8,500 or best offer. Call after 5pm. 685-2680
DODGE 1990 - W-150, Power Ram, 4x4, V8, automatic, air, red, Like new, \$8988.
CAMPBELL
 Dodge 538-1500

824 Jeeps & Other 4-Wheel Drives
BRONCO 1984, 4 wheel drive, automatic, V6, \$2750. 455-5566
TYME AUTO 455-5566
CHEVROLET 1989, \$10 pick up, 4x4, Tahoe, V8, automatic, air, power windows/locks, 28,000 miles. Only \$885.
MATICK CHEVY 531-7100
CHEVROLET 1990, Silverado, 4x4 pick up, 350 V8, automatic, air, tilt, cruise. Only \$12995.
MATICK CHEVY 531-7100
CHEVROLET 1988 4x4, 1/2 ton with sunroof, \$7500. 421-2886
453-6838
CHEVY BLAZER 1984, Air, Tahoe, automatic, am/fm cassette, power windows. Trailer package \$2000/best. After 5pm. 442-0528
824 Jeeps & Other 4-Wheel Drives
BLAZER-1984 Full size, 305 V8, automatic, well maintained, runs great, \$3,800. 437-7144
BLAZER 1986, \$10, 4x4, loaded sunroof, 5 speed, highway mi, good condition, \$4200/best. 887-1832
BLAZER 1989, full size, loaded, \$11,200/best. 261-9096
BLAZER 1991, \$10; Tahoe, 4.3 V8, automatic, w/ 4x4, loaded, \$11,900. MATICK CHEVY 531-7100
BRONCO II, 1987 xlt - 2-tone red/white, manual transmission, full power, \$6500/best. 462-0596
CHEROKEE 1989 Sport, black 2 door, 4x4, 55,000 mi., \$11,000. Great shape. Mike, 455-5544
CHEROKEE-1991 Limited, white, fully loaded, 34,000 miles. 335-2115 \$18,500.
CHEVY 1988 K-15 4x4, 5.7L, fully loaded, tool box, cruise control, bedliner, am/fm cassette, air, power windows & door locks, tilt, runs & looks great. Must sell, \$8,500 or best offer. Call after 5pm. 685-2680
DODGE 1990 - W-150, Power Ram, 4x4, V8, automatic, air, red, Like new, \$8988.
CAMPBELL
 Dodge 538-1500

824 Jeeps & Other 4-Wheel Drives
GEO 1991 TRACKER 4x4 Convertible, brand new oversized tires & chrome rims. Only \$10,295.
GORDON CHEVROLET 458-5290
GMC JIMMY 1987, all options, low miles, must sell. 464-7584
GMC SUBURBAN 1991 - 4X4, Loaded, low miles \$22,980
BILL FOX CHEVROLET 651-2262
GMC 1988 - Jimmy, 4x4, black, automatic, air, new engine, new brakes, excellent, \$6850. 688-0163
GMC 1989 - JIMMY, 68,000 miles, great condition, Gypsy package, loaded, \$9000. 788-1949
JEEP COMANCHE 1990 - 4X4, El-aminator package, 6 cylinder, automatic. Like new, \$8488
CAMPBELL
 Dodge 538-1500
JEEP Wrangler 1990 black/black soft top, 5 speed stick, 66,000 highway mi., new tires, Sony/CD player, Clean. Super!! \$7,750. 750-6492
JEEP 1987 WRANGLER - automatic, V6, white letter tires, alloy wheels \$6695
FOX HILLS
 Chrysler-Plymouth 961-3171
JEEP 1988 Cherokee LTD, 4 wheel drive, 20,000 mi, leather interior, excellent shape, \$14,200. 626-6341
JEEP 1988 COMANCHE Pickup, stick, stereo, & more. Only \$3895. DICK SCOTT Garden City 522-7820
JEEP 1990 CHEROKEE Sport - 4.0L, air, cruise, tilt, alloy wheels, tinted windows & more. 1 owner trade, \$12,688
LES STANFORD CHEVROLET-GE0 565-6000
FORD, 1991, F250 Super cab, 4x4, XLT, Diesel, loaded, \$19,400. DEMME FORD 721-2600
FORD 1992 - F150, XLT 4 wheel drive, 21,000, extra sharp! \$14,500 453-2424
HINES PARK LINCOLN-MERCURY 453-2424

825 Sports & Imported Cars
ACURA 1990 INTEGRA GS, sunroof, like new, \$12,222. MATICK CHEVY 531-7100
ACURA 1988 LEGEND - 4 door, excellent condition, sunroof, new tires, \$7195. 458-3884
ACURA 1988 LEGEND Sedan, full power, moonroof, 5 speed, excellent condition, \$9950/best. 884-7718
ACURA 1989 INTEGRA, LS-power sunroof, excellent tires/brakes, 74,000, \$7500/best. 313-229-0874
Acura 1990 Integra LS-\$9,850/best. 32,000 mi, silver, automatic, loaded, extended warranty. 333-2128 874-0767
AUDI 1983 - 5000, excellent condition, low miles, loaded, \$3500 or best. 474-0767
AUDI 4000, 1987 Quattro CS - All power options, air, 5 speed, low miles. Great car, \$5900. 626-7448
BMW 1985 325E, White & blue, automatic, loaded, 58,000 miles, like new, garage kept, \$6500. 775-6834
BMW 1988 325i - Mint condition, Best offer. Ask for Sharon W. 524-1600
BMW 1990 325i, black on black, excellent condition, \$16,950.274. 6052 or 721-5677
BMW 1990 525i - Loaded, sunroof, leather interior, excellent condition, 80,000 miles, \$16,900. 644-3122

825 Sports & Imported Cars
BMW 1988 325i - Automatic, air, sunroof, like new, \$12,222. MATICK CHEVY 531-7100
CORVETTE, 1978 - LOADED, 19,000 mi., wife's car, \$12,995. 688-2061
CORVETTE 1982, Low miles, glass T-tops, white with red interior, \$11,500. 668-2987
CORVETTE 1987 - automatic, black/gray interior, excellent shape, all power, 2 tops, \$12,999. 591-9209
CORVETTE 1992 - Polo green, tan interior, 14,000 miles, 6 speed, CD, adjustable ride, \$27,000. 397-5942
DATSUN 1983, ZX2 + 2, good condition. 855-4522
HONDA 1985 Accord LX - 4 door, Gray, automatic, air, cruise power windows & steering, 158,000 Hvy. mi., \$2375. Call after 5pm 380-2752
HONDA, 1988, Accord LX, 5 speed, loaded, 60,000 miles, excellent condition, \$6500. After 6 937-8839
HONDA, 1990, CRX Si, like brand new, fully loaded, \$7998
TOWN & COUNTRY 474-6750 DODGE 474-6666
HONDA 1989 MX-6, white, 5 speed, air, new brakes & tires, good condition, 62,000 mi, \$3800. 229-3161
MAZDA 1989 323 Sedan, air, automatic, power brakes/steering, cassette, \$3,800, 4-6pm. 523-1481
MERCEDES, 1981, 3000, silver, high miles, good condition, dealer serviced, \$7,000. 453-3253
PORSCHE, 1983 944 - Black, 5 speed, high mileage, over \$3000 in recent repairs, \$6950. 416-8955
PORSCHE, 1987, 944, immaculate, low mileage, leather, sunroof, ABS, garaged, \$13,420/best. 474-5622

825 Sports & Imported Cars
MASERATI 1990 TC, 5 speed, Turbo, convertible/hardtop. Loaded! Mint! Best offer. Call. 879-8399
MAZDA 1983 - RX7, bronze, am/fm cassette, sunroof, new tires/brakes, \$2,100. 455-7550
MAZDA 1985 - Freshman red, \$2850. TYME AUTO 455-5566
MAZDA 1986, 626, 55,000 miles, all options, excellent condition, \$4500. 540-8930
MAZDA 1987, RX7, 5 speed, 52,000 miles, AM/FM cassette, air, sunroof, \$5900/best. Message. 353-7114
MAZDA 1988 323SE, 4 door, air, stereo tape, excellent condition, \$3400/negotiable. 453-1072
MAZDA 1989 MX-6, white, 5 speed, air, new brakes & tires, good condition, 62,000 mi, \$3800. 229-3161
MAZDA 1989 323 Sedan, air, automatic, power brakes/steering, cassette, \$3,800, 4-6pm. 523-1481
MERCEDES, 1981, 3000, silver, high miles, good condition, dealer serviced, \$7,000. 453-3253
PORSCHE, 1983 944 - Black, 5 speed, high mileage, over \$3000 in recent repairs, \$6950. 416-8955
PORSCHE, 1987, 944, immaculate, low mileage, leather, sunroof, ABS, garaged, \$13,420/best. 474-5622

NO HASSLE PRICES

All used cars and trucks red-tagged with our NO HASSLE prices for your buying convenience.

'92 CORSICA Air, 6 cylinder, AM/FM stereo, many extras, 4 to choose from. \$10,444	'91 S-10 PICKUP Ridely wheels, rear step bumper. \$5959	'87 MERCURY GRAND MARQUIS Loaded, set for delivery! \$6565
'87 CAVALIER Automatic, air, cruise, tilt, power locks, 2 tone sharp. \$4444	'92 METRO 4 door, automatic, air, AM/FM stereo, unbelievable value! \$6888	'92 PRIZM Automatic, air, AM/FM stereo, won't last of this price. \$8668
'92 CAPRICE CLASSIC Super loaded, 2 to choose. \$13,888	'90 LUMINA EURO Loaded, aluminum wheels, 2 to choose. \$9449	'88 CHRYSLER 5TH AVENUE Loaded, leather interior, real plush! \$5888
'86 CELEBRITY Air, AM/FM, stereo, priced to sell! \$3777	'92 CAVALIER RS Automatic, air, AM/FM stereo, priced to sell. \$8989	'88 COUGAR Loaded! Sale Price! \$5959

Most cars guaranteed 3 months or 3000 miles

Lou LaRiche OPEN SATURDAY 10-4
 CHEVROLET GE0 SUBARU
 LOCAL 453-4600 METRO 961-4797
 40875 Plymouth Road, Plymouth

BLACKWELL FORD'S SUMMER IN NOVEMBER SALE

'86 TAURUS LX 4 DOOR Automatic, air, full power, sharp. \$3988	'88 MUSTANG CONVERTIBLE Automatic, air, cassette. \$5988
'90 RANGER 4x4 Automatic, 6 cylinder, low miles, see this one. \$8988	'89 T-BIRD Automatic, air, full power, tilt & cruise. \$7488
'91 AEROSTAR XLT EXTEND All the extras, 17,000 miles. \$12,988	'89 TAURUS SHO 5 speed, air, full power, low miles. \$8988
'91 F-150 XLT PICKUP Automatic, air, 13,000 miles. \$11,988	'92 GRAN MARQUIS LX 4 DOOR All the extras, leather trim. \$16,988
'87 TAURUS LX Station Wagon Automatic, air, full power, 56,000 miles. \$5788	'89 PROBE GL Automatic, air, stereo cassette. \$5788

Blackwell FORD
 IF YOU DON'T KNOW USED CARS, KNOW YOUR DEALER!
 41001 PLYMOUTH RD., AT HAGGERTY, PLYMOUTH, MI 48130
 453-1100

BUDGET CAR CLEARANCE

'86 MAZDA 323 70,000 miles, transportation special. \$595	'88 CORSICA V-6, automatic, air, clean. \$4495
'88 CAVALIER 2 DOOR Automatic real clean \$1995	'86 SAAB 900 loaded, hurry on this one! \$1995
'86 DODGE FULL SIZE PICKUP Automatic, 46,000 miles. \$4995	'82 CELEBRITY Automatic, air, low miles like new! \$1795
'84 CAVALIER Strong motor, automatic, air. \$695	'87 CELEBRITY EUROSPORT Automatic, air, full power. \$2995
'85 MERKUR XR4TI Aluminum rims, power roof, all the toys. \$2395	'87 RELIANT 4 door, a steal at \$995

GORDON Chevrolet
 Ford Road Just West of Merriman
427-6200
 All Vehicles Subject To Prior Sale

LIQUIDATION SALE

WE'RE OVERSTOCKED WITH OVER 150 SELECT USED VEHICLES THE BOSS SAYS THEY'VE GOTTA GO...
PRICES & PAYMENTS SLASHED!!!

\$99 Down CASH or TRADE 1990 FESTIVA \$83*/mo.	\$149 Down CASH or TRADE 1989 ESCORT \$139*/mo.	\$199 Down CASH or TRADE 1987 T-BIRD \$143*/mo.
1991 RANGER 38,000 Miles \$159*/mo.	1990 MUSTANG \$164*/mo.	1989 PROBE \$169*/mo.
1989 T-BIRD \$169*/mo.	1990 PROBE \$173*/mo.	1990 T-BIRD \$177*/mo.
1988 CROWN VICTORIA \$189*/mo.	1989 AEROSTAR Low Miles, Like New. \$205*/mo.	1990 BRONCO II XLT 4X4 \$249*/mo.
1991 EXPLORER 4X4 \$289*/mo.	1991 AEROSTAR Loaded \$9,600	1991 LINCOLN CONTINENTAL \$17,950
1992 CROWN VICTORIA \$15,900	1992 T-BIRDS Several To Choose. \$11,900	1992 TAURUS Several To Choose \$11,900

NORTH BROS Established 1936
421-1300
 1400 FORD ROAD WESTLAND

*With approved credit. Plus tax, title and license. 1987 models based on 42 monthly payments at 11.0% A.P.R. 1988 models based on 42 monthly payments at 9.0% A.P.R. 1989 models based on 48 monthly payments at 8.25% A.P.R. 1990 models based on 54 monthly payments at 7.5% A.P.R. 1991 models based on 60 monthly payments at 8.25% A.P.R. 1992 Models based on 66 monthly payments at 8.25% A.P.R. All units subject to prior sale.

Special Attractions FRIDAY November 27 At... BLACKWELL FORD

Stop by and visit Former Detroit Lion **MIKE UTLEY** between **1-3 P.M.**

Blackwell FORD PERFORMS
453-1100
 41001 Plymouth Rd. Plymouth
 SHOWROOM OPEN UNTIL 9 PM MONDAY & THURSDAY

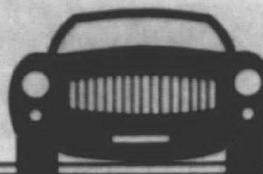

AUTOMOTIVE

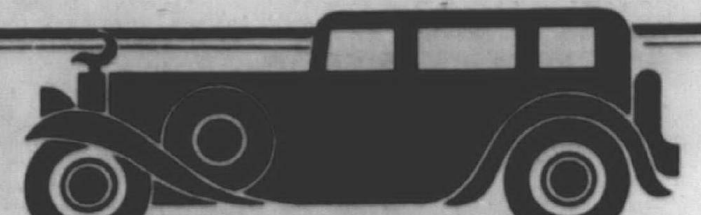

825 Sports & Imported Cars

MERCEDES, 1987 560SEC, black/palmetto interior, 58,000 miles, excellent condition. CD player & 4-speaker. \$35,500. 332-3900, ext. 132

TYME AUTO 455-5566

MERKUR 1984, ivory, with all options, very low miles. TYME does it again only \$3350.

TYME AUTO 455-5566

MERKUR 1984, 4 door, white, loaded, 5 speed, 63,000 miles. \$4,200. Eves 651-5147 or days, ask for Dan 433-7353

PORSCHE 1984, 944. Power steering/brakes, 5 speed, electronic sunroof, air. Excellent Non Smoker. Stored winters. \$9,000. 685-1340

PORSCHE 1984, 944. Power steering/brakes, 5 speed, electronic sunroof, air. Excellent Non Smoker. Stored winters. \$9,000. 685-1340

PORSCHE 1984, 944. Power steering/brakes, 5 speed, electronic sunroof, air. Excellent Non Smoker. Stored winters. \$9,000. 685-1340

PORSCHE 1984, 944. Power steering/brakes, 5 speed, electronic sunroof, air. Excellent Non Smoker. Stored winters. \$9,000. 685-1340

852 Classic Cars

DODGE 1981 Pioneer - 22,000 one owner miles, in storage 25 years. Car's in showroom condition. Stable black beauty. Must see, feel & smell to appreciate. Drive anywhere, a real head-turner. \$3,500. 589-2771

PONTIAC 1973 Luxury Lemans. Sharp Surron car, 350 automatic, air, power steering & brakes, bucket seats, console, \$4200 or trade for newer car/truck. 552-8429

RANCHERO 1987, restored Tennessee car, American or best offer. 5 Lyons. 437-4783

854 American Motors

ALLIANCE 1985 - automatic, air, 4 door. Only \$1995.

FOX HILLS
Chrysler-Plymouth
455-8740 961-3171

THANKSGIVING WK. SPECIAL
ENCORE 1984, jade green, looks & runs good, a real turkey! \$899.

TYME AUTO 455-5566

856 Buick

CASH
For your used car. Dealer needs cars. My wife says I pay too much. Call for phone appraisal.

TYME AUTO 455-5566

CENTURY, 1983, \$1650 or best. Runs great, clean, new engine installed at 48,000. Brakes, 261-3783

CENTURY 1984 LIMITED, 4 door, V-6, loaded, leather, sunroof, power seats, and more! No rust! \$1500. Select Auto. 651-2277

LA SABRE, 1992 LIMITED - 12,000 mi., excellent condition. \$17,000. 313-229-3322

LE SABRE 1989 LIMITED
Loaded, climate control, excellent condition. \$8900.

227-4900 478-5947

858 Buick

CASH
Dealer will sell on consignment or pay cash for your used car. Call for cash price!

TYME AUTO 455-5566

ELECTRA 1984 Wagon, excellent condition, new tires/brakes & more. Runs like new. Must see! \$3,000/best. Joe, Eves 680-1819

LESABRE, 1988, Ltd., 4 door, loaded, good condition. 50,000 miles. \$12,500. 348-3245 or 591-4892

LESABRE, 1991, 4 door, brown anti-lock brakes, 24,000 miles. \$12,500. 348-3245 or 591-4892

LESABRE, 1992 Custom Sedan, equipped, red, 14,900. 624-7582

REGAL GRANDSPORT 1989 - real sharp, loaded! \$6495

GORDON CHEVROLET 458-5250

REGAL 1981 - good condition, less than 80,000 miles. Asking \$1500. 341-4744

REGAL 1988, Coupe, 45,000 Miles, V-6, stereo tape, cruise, tilt, locks, wires, split seat. \$6275. 852-2819

REGAL 1988 - Red, loaded including phone, excellent condition. 67,000 miles. \$5,575. 455-1040

REGAL, 1991 GS sedan, clean, loaded, leather, low miles, \$13,500. 646-2909

REGAL 1992 - GS, 2 door, loaded, power, sunroof, cd, dark red, 26,500 miles, excellent. \$17,000. Day 353-5948 eves 629-6258

SKYLARK, 1980, runs well but needs transmission work. \$250/best. Ask for Jerome 326-1891

SKYLARK 1988 Limited, 4 door, V8, loaded, excellent condition. \$2950. 624-3357

SKYLARK 1987 - 38,000 miles, air, stereo, much more. Limited warranty. Like new. Only \$5,495.

LES STANFORD
CHEVROLET-GEO 565-8000

SOMERSET 1988 - Good condition, runs great. \$1,700 or best offer. 537-5809

SOMERSET, 1986 - V6, two tone blue, many extras, excellent interior, body good, commuter car. \$1795. days: 452-8906, eves: 458-2750

858 Cadillac

CADILLAC 1986 LIM0, 75 series, 87000 actual miles, black, main condition. \$10000/best. 380-0137

DEVILLE, 1988, loaded, extra clean, telephone, \$6200/best offer. 328-8741

ELDERADO 1984 - A silver beauty, 62,800 miles. Only \$3995. Feister Auto & RV Sales. 721-2400

ELDERADO 1984, good condition, \$2000. 961-1814

FLEETWOOD BROUGHAM, 1988, runs, drives & looks excellent, dealer maintained, 90,000 pampered miles. \$6295. 595-0985

FLEETWOOD 1990 - Every option Cadillac offers. Incredibly clean, black/red interior, 63,000 miles. \$13,000. Call 652-3149 or 978-4400

SEDAN DEVILLE 1989 - dark blue with leather, loaded, excellent condition. 38,000 mi. \$12,900. 780-9395

SEDAN DE VILLE 1978, black, full power, leather, good condition, \$1500/best. After 4:30 728-5421

SEDAN DE VILLE 1990, leather, cast wheels, must see, \$14,500 or best offer. 454-6033

SEDAN DEVILLE, 1988, platinum gray leather, warranty til July '93, 31,000 miles, \$13,900. 542-5345

SEDAN DEVILLE, 1992, white, blue leather, security system, low mileage, \$20,500. days: 398-9711 eves: 464-8392

SEDAN DEVILLE, 1986, Loaded. New tires. Body & engine in excellent condition. \$4300/best. 557-5655

SEVILLE, 1992 - Stunning front beige, remote keyless, neutral leather, theft deterrent. \$28,500. 380-0455

860 Chevrolet

ALUMINA, 1992 2-34 Coupe. Loaded! Black Beauty. Bose stereo. \$13,750. Call. 887-3944

BARETTA 1988 GT, red, grey interior, 42,000 miles, power windows, locks, \$4900. 652-4033

BARETTA 1991 GT, 45,000 miles, V-6, am/fm cassette, sunroof, alarm, \$9700 negotiable. 683-9124

BARETTA 1988 GT, automatic, condition, \$4,800. 978-0335

BARETTA 1989 - automatic, air, hury, only \$4995. GORDON CHEVROLET 458-5250

860 Chevrolet

ATTENTION
A PRE THANKSGIVING SALE
50 Vehicles must go
Save up to 50% over list prices
Wed. 6pm, Nov. 25th
OPEN TO PUBLIC

MICHIGAN AUTO AUCTION
33640 MICHIGAN AVE
328-6400
Regular sale every Thur. 6pm

BARETTA 1989 GT V-6. Loaded! GM Executive car. Well maintained. White. \$5775. 478-9288

BARETTA, 1990 GTZ - Quad-4, sunroof, loaded, good condition, White, \$9550. 846-1408

CAMARO 1983 BLACK
Needs work. \$950.00
Call between 9 & 4: 421-3720

CAMARO 1985 Berlina, V6, runs great, looks good, loaded, \$1975/best. Call 6pm 478-9288

CAMARO, 1986, iron Z, T tops, red, loaded, low miles, w/c car, \$6600 or best. Days: 295-1750. Nights and weekends. 961-5119

CAPRICE CLASSIC 1977, automatic, air, \$875. 532-6223

CAPRICE CLASSIC 1980 - 16,000 miles, like new. HUR \$12,485. GORDON CHEVROLET 458-5250

CAPRICE CLASSIC BROUGHAM 1988 - Fully loaded, like new! \$8990. BILL FOX CHEVROLET 651-2262

CAPRICE CLASSIC 1987 Wagon, 40,000 miles, super clean, only \$4495. 424-9932

CAPRICE 1987 Classic Brougham, V8, automatic, air, power windows, power locks, tilt, cruise, extra clean, only \$8,488. 458-5250

CHEVY 531-7100

CAPRICE 1990, power windows/tilt, like new. HUR \$12,485. GORDON CHEVROLET 458-5250

MATICK CHEVY 531-7100

CASH
Dealer will sell on consignment or pay cash for your used car. Call for cash price!

TYME AUTO 455-5566

CAVALIER 1984 - 2 door, automatic, air, \$995. GORDON CHEVROLET 458-5250

CAVALIER 1987 - air, stereo, extra clean. \$1995. 538-5847

CAVALIER 1987 RS, automatic, air, sunroof, stereo cassette, like new. \$4,495. 452-4219

CAVALIER 1989 - 2 door, new tires exhaust, extended warranty, \$4,700. \$4,700. \$4,700. 395-4719

CAVALIER 1989 RS - automatic, air, stereo, & more. Only \$4395. DICK SCOTT GARDEN CITY 522-7820

CAVALIER 1989 Wagon - low miles, automatic, air, stereo, much more. \$4,995.

LES STANFORD
CHEVROLET-GEO 565-8000

CAVALIER, 1991 RS - Loaded, excellent condition. 29,500 mi. \$5,500. Days: 538-7909; eves: (313) 752-2916

CAVALIER 1990 - 4 door, automatic, air, am/fm \$5960. BILL FOX CHEVROLET 651-2262

CELEBRITY EUROSPORT 1987 - automatic, air, full power. \$2495. GORDON CHEVROLET 458-5250

CELEBRITY 1984 Euro Wagon, 6 cylinder, loaded, good condition. Asking \$1890. Evenings: 532-7329

CELEBRITY 1982 - super clean. Only \$1795. GORDON CHEVROLET 458-5250

CELEBRITY 1989 Wagon - V6, automatic, air, tilt, defroster, only \$8,588. MATICK CHEVY 531-7100

CHEVETTE 1980, blue, hatchback, runs good, looks fair. \$300. 335-3565

862 Chrysler

CASH
For your used car. Dealer needs cars. My wife says I pay too much. Call for phone appraisal.

TYME AUTO 455-5566

FIFTH AVENUE 1991 - mark cross, every option, leather, like new. \$12,988

BRUCE CAMPBELL
Dodge 538-1500

LEBARON 1989 - coupe, red, 58,000 miles, automatic, air, am/fm \$5,000. 642-3933

LEBARON 1989 - convertible, automatic, air, loaded, only \$7995. 648-8423

FOX HILLS
Chrysler-Plymouth
455-8740 961-3171

NEW YORKER 1989 Landau - 4 door, full power, digital dash, warranty, extra clean. \$9300. 642-8351

NEW YORKER 1985, black/grey leather, loaded, good condition, 97,000 miles, \$2300. 651-1633

NEW YORKER 1987 - black, loaded, leather seats, good condition, 100,000 miles, \$2,100. 559-6499

DODGE B-250 1992 - maxi cargo van, V8, automatic, like new. \$11,988. BRUCE CAMPBELL Dodge 538-1500

COLT 1981 - 2 door, red, 21,000 miles. \$5,495. FOX HILLS Chrysler-Plymouth 455-8740 961-3171

DAYTONA, 1985, Auto, air, Loaded! GM Metal Built! 72,000 miles. \$2150. Call. 649-6361

DAYTONA, 1987, 2.5L, 5 speed, new parts, air, am/fm, black. \$2450. 328-6400

DIPLOMAT 1987, 318 V8, power steering & brakes, automatic, air, AM-FM, excellent condition. \$4500. 454-9932

DYNASTY, 1992, 2 to choose from, new car warranty, new car financing. 596-1619

TOWN & COUNTRY
474-6750 DODGE 474-6668

OMNI 1987, parts, tow away, \$200. 357-1619

SHADOW 1991 ES - Turbo convertible, every option, balance of new car warranty, only \$9995. FOX HILLS Chrysler-Plymouth 455-8740 961-3171

864 Dodge

DAYTONA 1991 ES - All power, cassette, V6, balance of new warranty, \$9,995.

FOX HILLS
Chrysler-Plymouth
455-8740 961-3171

DYNASTY 1992 - V6, automatic, air, loaded. 19 to choose. \$10,488

BRUCE CAMPBELL
Dodge 538-1500

OMNI 1988 - automatic, air, 4 door, 1 owner, \$2995

DICK SCOTT Garden City 522-7820

SHADOW 1987 - ES, turbo, 60,000 miles, black exterior, great condition. \$3900. 648-8423

SHADOW 1990 ES - good condition, well-equipped. \$5995. 299-5598

SHADOW 1991 - highline, low miles, like new. \$5844

BRUCE CAMPBELL
Dodge 538-1500

SHADOW, 1991, 5500 miles, automatic, air, 4 door, air bag, black cherry, \$7800. SPIRIT 1989 Turbo, 4 door, white, blue trim, all the buttons, only \$4995. Feister Auto & RV Sales. 721-2400

866 Ford

ALWAYS MORE TRANSPORTATION SPECIALS
50 cars priced under \$995. E & M 397-2201

ATTENTION
A PRE THANKSGIVING SALE
60 Vehicles must go
Save up to 50% over car lot prices.
Wed. 6pm, Nov. 25th
OPEN TO PUBLIC

MICHIGAN AUTO AUCTION
33640 MICHIGAN AVE
328-6400
Regular sale every Thur. 6pm

CROWN VICTORIA, 1992 LX - 114 package, loaded, black/black, leather, \$15,900. 781-3034

ESCORT GT 1988 - 5 speed, air, stereo, cassette. Only \$4495

Jack Demmer Ford
AFFORDABLE USED CARS
721-5020

ESCORT 1985 - good transportation. Only \$995. GORDON CHEVROLET 458-5250

ESCORT 1986 Stationwagon, automatic, air, 95,000 miles, excellent condition. \$1400. 397-2449

ESCORT 1991 - automatic, air, cassette, cruise, 4 door, like new. \$7,995. FOX HILLS Chrysler-Plymouth 455-8740 961-3171

868 Ford

CROWN VICTORIA 1988 LX, loaded, 58,000 miles. A-1 condition. \$2800. 637-0882

ESCORT, 1987 - White, great transportation. Power steering & brakes, stereo, 4 speed stick, excellent condition. \$1175. After 6pm. 459-3179

ESCORT, 1989 GT. Power steering/brakes, cassette, air, 18/cruise. Well kept. \$2500/other. Call. 588-7898

ESCORT 1988 LX, light blue, 5 speed, air, new brakes, no rust. 274-9360

ESCORT, 1989 GT. 5 Speed, cassette, cruise, air, new tires, etc. Only 40,000 miles. \$3500. 328-7688

ESCORT, 1989 LX - 4 door excellent condition, 37,000 mi. Automatic, air, power steering/brakes, am/fm, new tires. Relocating. \$3850. Call or leave message. 851-7717

ESCORT - 1990 LX, 4 door, automatic, air, good condition. \$5,500. 652-3634

ESCORT, 1991 GT, loaded. \$7,500. DEMMER FORD 721-2600

ESCORT, 1991 LX - 2 door, 5 speed, 11,000 mi., am/fm, power steering & brakes, no air. \$5900. 642-4245

ESCORT, 1991 LX, loaded, from only \$5,900. DEMMER FORD 721-2600

ESCORT 1991 - 2 door, air, am/fm cassette, 5 speed, power steering/brakes. 358-5290

EXP 1986, excellent condition, 5 speed manual, AM-FM stereo cassette, black with grey interior. 8AM-5PM 234-4888 6PM-9PM 647-6645

ESCORT 1985 - good transportation. Only \$995. GORDON CHEVROLET 458-5250

ESCORT 1986 Stationwagon, automatic, air, 95,000 miles, excellent condition. \$1400. 397-2449

ESCORT 1991 - automatic, air, cassette, cruise, 4 door, like new. \$7,995. FOX HILLS Chrysler-Plymouth 455-8740 961-3171

ESCORT 1991 - 5-speed, air, am-fm cassette, power steering & brakes, low mi., excellent condition. \$6,600 eves. 358-5290

EXP 1986, runs excellent, 57,000 miles, good condition, \$1800 or best offer. 591-1813

FORD, 1990 Super Wagon XL, 15 passenger, 460, dual air, from \$10,300. DEMMER FORD 721-2600

LTD 1984 Square Wagon, original owner, 58,000 miles, well maintained, no smoking, perfect condition, no rust, loaded. Trailer towing package. Best offer. Eves. 681-8268

LTD 1984 STATION WAGON V6, full power & air, only \$1995. Feister Auto & RV Sales. 721-2400

MUSTANG 1984, Convertible, red, automatic, 6 cyl, low miles, new top, locks new. \$3,995. 628-0844

MUSTANG 1984, Convertible Garage kept. \$3400. TYME AUTO 455-5566

MUSTANG-1985, Excellent condition, automatic, Kenwood amfm cassette, \$2500/best. Call Chris days: 538-8008, Jim eves: 535-3780

MUSTANG 1987 GT, stored winters, 66,000 miles. Loaded. \$4500. Call after 4:30PM. 531-8256

MUSTANG 1988 LX, 37,000 miles, from Texas, loaded, CLEAN!! 661-4574

MUSTANG 1989 GT - 44,000 miles, great condition, sunroof, loaded, 5 speed, original owner, \$3300/best. Call after 4:30PM. 585-0103

'92 Model Clearance

'92 SPIRIT ES 4 DOOR

- Brite White
- Driver's Side Airbag
- Power Steering
- Power Brakes
- Automatic
- Air Cond.
- Tilt Wheel
- Cruise Control
- Power Windows
- Power Locks
- Power Driver's Seat

\$12,995*

*Plus tax, title, dest., doc fees. Rebates applied to dealer. Offer expires 11/30/92. Excludes prior sales.

TOWN & COUNTRY DODGE

ON GRAND RIVER
at Orchard Lake and 9 Mile
31015 GRAND RIVER FARMINGTON HILLS
474-6750

1992 CLEARANCE

This may be Michigan's largest inventory! Achievas, Cieras, Cutlass Supremes, 88's, 98's, Tornados, Bravadas, Silhouettes

New 1992 Achieva S Coupe
Air, automatic, AM/FM stereo, electric rear defogger, stk. #3271. After rebate:

\$11,953*
GM EMPLOYEES
Additional Rebate \$717
1st Time Buyer \$400

New 1992 Cutlass Supreme Coupe
Air, automatic, AM/FM stereo, electric rear defogger, whitewalls, stk. #3130. After rebate:

\$12,952*
GM EMPLOYEES
Additional Rebate \$797

New 1992 Eighty-Eight Royale Sedan
Electric rear defogger, air, power windows, AM/FM stereo, drivers side airbag. Stock #3480.

\$15,518*
GM EMPLOYEES
Additional \$933 Rebate

Chrysler 24555 Michigan Ave. 1 block W. of Telegraph Dearborn **563-6500**

*Plus tax, license, rebate to dealer

868 Ford

ALWAYS MORE TRANSPORTATION SPECIALS
50 cars priced under \$995. E & M 397-2201

ATTENTION
A PRE THANKSGIVING SALE
60 Vehicles must go
Save up to 50% over car lot prices.
Wed. 6pm, Nov. 25th
OPEN TO PUBLIC

MICHIGAN AUTO AUCTION
33640 MICHIGAN AVE
328-6400
Regular sale every Thur. 6pm

CROWN VICTORIA, 1992 LX - 114 package, loaded, black/black, leather, \$15,900. 781-3034

ESCORT GT 1988 - 5 speed, air, stereo, cassette. Only \$4495

Jack Demmer Ford
AFFORDABLE USED CARS
721-5020

ESCORT 1985 - good transportation. Only \$995. GORDON CHEVROLET 458-5250

ESCORT 1986 Stationwagon, automatic, air, 95,000 miles, excellent condition. \$1400. 397-2449

ESCORT 1991 - automatic, air, cassette, cruise, 4 door, like new. \$7,995. FOX HILLS Chrysler-Plymouth 455-8740 961-3171

GUARANTEED Credit Approval

Drive Home Today - Immediate Delivery!

- Everyone deserves a second chance.
- Your job is your credit.
- Bankruptcy Repaired. No Problem.
- Re-establish your credit.
- Financing for everyone.

Ask for Mr. Karr
261-6900
ACTION OLDSMOBILE
33850 Plymouth Road Livonia - Open Sat. 10-4

Subaru "SWITCH to LaRICHE" SUBARU

'92 LOYALE WAGON

Power windows & door locks, air cond, tilt with memory, power rack & pinion steering, power front disc brakes, electric mirrors, rear defogger, tinted glass, roof rack, rear air deflector, analog gauges w/trim-meter, halogen headlamps, much more, white. Stock #2816.

Was \$11,752
NOW \$10,699*

Subaru. What to drive.

Subarus Cost Less In Plymouth!
*plus tax & license

Lou LaRiche SUBARU.

LOCAL 453-4600 METRO 961-4797
40875 Plymouth Road, Plymouth

Red Hotman TOYOTA

PRE THANKSGIVING SALE

NEW '93 TOYOTA COROLLA
All weather, cassette, conversion group, mats. Stock #003193.
LIST.....\$13,819 YOUR PRICE **\$12,595***

NEW '93 TOYOTA TERCEL
All weather guard. Stock #283423.
LIST.....\$8358 YOUR PRICE **\$7595***

NEW '92 TOYOTA CELICA CONVERTIBLE
Air, automatic, all alloy wheels, cruise, compact disc, power, option, mats. Stock #25200.
LIST.....\$25,808 YOUR PRICE **\$21,518***

NEW '92 TOYOTA PASEO
All weather, air, automatic, alloy wheels, cruise, cassette, sunroof, mats, spoiler. Stock #122217.
LIST.....\$15,324 YOUR PRICE **\$13,495***

NEW '93 TOYOTA PREVIA DELUXE
Automatic, air, power, option, mats. Stock #088221.
LIST.....\$22,957 YOUR PRICE **\$19,995***

NEW '93 TOYOTA CAMRY DELUXE
Air, automatic, cruise, cassette, mats. Stock #187386.
LIST.....\$17,738 YOUR PRICE **\$15,495***

NEW '92 TOYOTA PICKUP
All weather, air. Stock #000573.
LIST.....\$10,158 YOUR PRICE **\$7595***

NEW '93 TOYOTA 4 RUNNER
Automatic, air, sunroof, cassette, mats. Stock #090633.
LIST.....\$26,832 YOUR PRICE **\$22,995***

TIRED OF GETTING THE RUN AROUND ON SALES & SERVICE? THEN SEE US!

DEAN SELLERS FORD

SPECIAL FORD EMPLOYEES SALE - A, X & Z PLAN HEADQUARTERS

NEW 1993 TAURUS GL
AS LOW AS **\$13,153^{93*}**

NEW 1993 AEROSTAR XL PLUS WAGON
AS LOW AS **\$13,874^{10*}**

NEW 1993 ESCORTS
AS LOW AS **\$8859^{93*}**

NEW 1993 RANGERS
AS LOW AS **\$8859^{93*}**

NEW 1993's WE LEASE FOR LESS
Ask about our special low lease payments!

NEW 1993 ESCORTS
ONE PRICE! **\$8981^{96*}**

NEW 1993 TEMPO GL 2 DR.
AS LOW AS **\$7839^{00*}**

NEW 1993 TIARA MOTORCOACH
These are Luxury VANS!
AS LOW AS **\$10,106^{20*}**

NEW 1993 F-150 PICKUP
133" Wheelbase
AS LOW AS **\$10,106^{20*}**

NEW 1993 TIARA MOTORCOACH
These are Luxury VANS!
Was \$24,195 NOW **\$17,849^{67*}**

Tiara Vans Meet or Exceed the Federal Motor Vehicle Safety Standards (F.M.V.S.S.) IN STOCK & READY FOR IMMEDIATE DELIVERY

OUR CUSTOMERS DEMAND THE FINEST SERVICE AND WE DELIVER!!

DAN SELLERS FORD

2600 MAPLE ROAD (15 Mile) between Crooks and Collidge IN TROY
643-7500
OPEN MON. & THURS. TIL 9

Red Hotman TOYOTA

FORD RD. at WAYNE RD. WESTLAND
721-1444

OPEN MON. & THURS. 10-6
DON'T MAKE THE MISTAKE OF NOT TRYING

TOWN & COUNTRY
474-6750 DODGE 474-6668

DAN SELLERS FORD

2600 MAPLE ROAD (15 Mile) between Crooks and Collidge IN TROY
643-7500
OPEN MON. & THURS. TIL 9



OPEN
Monday til 9
Friday 8:30-6
SATURDAY
10-4

Thanksgiving
Savings
Harvest

'93 CHEVY
1/2 TON PICKUP



- 8 Foot Bed
- AM/FM stereo cassette
- Tilt
- Cruise
- Power windows & locks
- Air

\$229*

36 mos. lease payment

Monthly Lease Payment	\$229
Refundable Sec. Dep.	\$250
Down Payment	\$900
Total Cash Due At Inception	\$1379
Total of Mo. Payments	\$8244

'93 LUMINA
SEDAN



- Split seat
- Rear defrost
- V-6
- Automatic overdrive
- Air
- Tilt
- Cruise
- Stereo

\$229*

36 mos. lease payment

Monthly Lease Payment	\$239
Refundable Sec. Deposit	\$250
Down Payment	\$1350
Total Cash Due at Inception	\$1829
Total of Mo. Payments	\$8244

3 Year/36,000 Mile
Zero deductible bumper
to bumper warranty

GM Employees Save
Even More!

Lou LaRiche

CHEVROLET GEO SUBARU

LOCAL 453-4600 METRO 961-4797
40875 Plymouth Road • Plymouth



Corner of
Plymouth Road & Haggerty

MICHIGAN

AUTO
AUCTION

INQUIRIES
CALL (313) 326-6400

PUBLIC
&
DEALERS
WELCOME

A
PRE-THANKSGIVING
SPECIAL SALE

60
VEHICLES
MUST GO!

SAVE UP TO 50%
OVER CAR LOT PRICES!

WEDNESDAY, NOV. 25TH
6:00 P.M.

WHERE SELLERS
COME TO SELL AND
BUYERS COME TO
BUY!!

SELL A CAR - BUY A CAR
SELL A TRUCK - BUY A TRUCK
SELL A VAN - BUY A VAN

33640 MICHIGAN AVE. • 3 MILES EAST OF I-275

WAYNE RD.

↓

RD.

MICHIGAN

VENOY

MERRIMAN

JUST EAST OF DOWNTOWN WAYNE • BETWEEN VENOY ROAD & WAYNE ROAD

\$2000
REBATES
or up to
5.9% APR
on select models
to qualified buyers

1993 GRAND PRIX SE 2 DOOR

Air, rear defogger, automatic 4 speed transmission, power windows, power locks, cruise, tilt, gauges, AM/FM cassette, BYP sport appearance package, cloth bucket seats

Stock #920908
LIST PRICE \$17,513

SALE PRICE \$14,960*

Lease \$217.37†
GM Opt II Deduct \$850.40



HOT AUTO DEALS FOR
WINTER

"NEW" 1993 GRAND AM SE 2 Door

Stock #930248



LIST PRICE \$14,554

SALE PRICE \$12,699*

FTB Deduct \$400
GM Option II Deduct \$703.95
Lease for \$184.67†

70 Available at Similar Savings!

Come in and see why Bob Jeannotte Pontiac is Michigan's

#1

Pontiac dealer for customer satisfaction for the second consecutive Model Year Masters Level 1.

NEW 1992 CONVERSION VAN
SANTA FE EXECUTIVE SERIES

3 1/2 ton, 125 wheel base, fabric shades, 350 EFI, 4 speed automatic, power sofa, power driver seat, front & rear heat, air, deluxe wood package, 9 color TV & VCR, fiberglass running boards, front aluminum step, power locks & windows, AM/FM cassette with equalizer, much more!

SALE PRICE \$21,995*

First Time Buyer Deduct \$400
Smart Buy \$415.71 per month
GM Option II Deduct \$912.55

LIST PRICE \$27,640



1992 BONNEVILLE SE 4 Door

Air, 55/45 split seat, power windows, power locks, tilt wheel, cruise, lamp group, rally gauges, AM/FM cassette, full covers and more.

Stock #920878

LIST PRICE \$20,027

SALE PRICE \$15,983*

GM Employees Deduct \$973.60



1993 BONNEVILLE SLE 4 Door

Leather 44/55 seats, air, AM/FM cassette with equalizer, 1SD option pkg., SLE appearance pkg., "Loaded."

Stock #930138

LIST PRICE \$23,823

SALE PRICE \$20,488*

GM Option II Deduct \$1,163.40



1993 SIERRA 4X4
FULL SIZE

Air, 4 speed automatic, bedline, AM/FM radio, full-size spare, sliding rear window, rear step bumper.

Stock #935079

LIST PRICE \$17,395

SALE PRICE \$15,395*

Smart Buy \$236.17** per month
GM Option II Deduct \$840
College Graduate Deduct \$400



1992 TRANS SPORT

Air, deep tinted glass, two paint, cast wheels, AM/FM cassette, 7 passenger seat, power windows, power locks, tilt, cruise, custom stripe and more.

Stock #920322

LIST PRICE \$19,510

SALE PRICE \$16,699*

Smart Buy \$281.43** per month
GM Opt Deduct \$940.25



1993 BONNEVILLE SLE 4 Door

Leather 44/55 seats, air, AM/FM cassette with equalizer, 1SD option pkg., SLE appearance pkg., "Loaded."

Stock #930138

LIST PRICE \$23,823

SALE PRICE \$20,488*

GM Option II Deduct \$1,163.40



LAST ONE!
1992 SUNBIRD LE 2 Door

Air, rear defrost, automatic, hi tech cast wheels, touring tires, tinted glass, sport mirrors, AM/FM stereo, power steering, power brakes, cloth bucket seats, GM Goodwrench alarm VS 100.

Stock #920829

LIST PRICE \$12,279

SALE PRICE \$10,274*

FTB Deduct \$400.00
GM Employees Deduct \$580.20
Smart Buy \$165.66** per month



1993 JIMMY 4 DOOR
4 WHEEL DRIVE

Air, automatic, 4.3 V6 enhanced engine, on/off road, Laredo tires, outside spare, power locks & windows, rear wiper, defogger, bucket seats, AM/FM cassette, tilt, cruise, much more!

Stock #935060

LIST PRICE \$22,651

SALE PRICE \$19,480*

36 Mos. Lease \$299.95
GM Opt II Deduct \$1108.80
College Grad Deduct \$400
GMAC 36 month lease - use tax, \$921.51 down, 1st payment, 15,000 miles per year, 10c per mile over 45,000 miles at lease end total payment \$10,796.20.



BOB JEANNOTTE
PONTIAC-GMC TRUCK

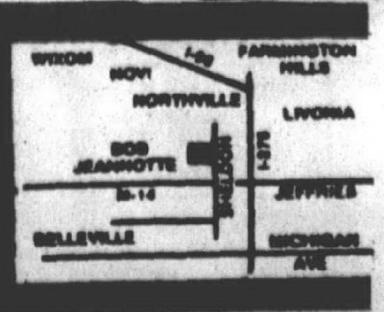

14949 Sheldon Road

(Just North of M-14, Jeffries Fwy.)

GM Employees Option I - Option II

PEP PLAN HEADQUARTERS

Suppliers Welcome

Hours: Mon. & Thurs. 9-9
Tues., Wed., Fri. OPEN MONDAY

453-2500

*Plus tax, title and license, rebates included where applicable.
**All smart buyers include 4% sales tax and \$2000.00 down payment 4 mos., 15,000 miles per year, 10¢ per mile over 60,000 miles. Customer has option to purchase said vehicle for pre-set value at inception. \$250 disposal fee if car turned in at end of 48 months. Customer responsible for excess wear and tear. Subject to credit approval.
†Lease based on 48 month closed end lease. \$2,000 down. 1st months payment and security deposit (sec. dep. rounded off to nearest \$25 increment over monthly payment) plus license fees required at lease inception. 4% mo. use tax incl. in payments. Mileage limitation of 15,000 per year with charge of 10 cents over the limit per mile. To get total payments, multiply monthly payment x 48. Lessee sub- approval and responsible for any excess wear and tear. Lessee also subject to insurability. Lessee has the option to purchase at lease end at the price of formula to be negotiated at lease inception with dealer. Rebates applied where applicable.

THE
Observer & Eccentric
NEWSPAPERS



HOLIDAY PARADE
OF
SAVINGS

A warm holiday invitation to revisit America's past from...

Terry Redlin

Second annual limited edition Christmas print!



NEW!

Edition of 29,500 s/n "Winter Wonderland" Second annual limited edition Christmas print—1992 14x24 inches \$150

In this spectacular holiday print Mr. Redlin recreates for us a special legacy. This beautiful night time image reminds us of a more innocent era in America's past when the countryside was at peace with itself and traditional family values reigned.

WILD WINGS GALLERY
975 W. Ann Arbor Trail
Plymouth, MI 48170
(313) 455-3400



GALLERY HOURS: Mon-Wed & Sat 10:00-6:00 Thurs & Fri 10:00-9:00 Sun 12:00-5:00
Holiday Hours Begin 11-27 - Mon-Fri 10 a.m.-9 p.m., Sat 10-6, Sun 12-5

Visit our gallery soon to see Mr. Redlin's colorful Americana and wildlife art prints and collector plates

Grundwald's
for Christmas...



for old-fashioned...

- Quality
- Service
- Taste!

Try our...
Handmade Fudge
Nut Brittles
Chocolates
Truffles
Sugarless Chocolates
also... Gift Tins

Also visit us at the Gibraltar Trade Center in Taylor

House of Fudge
& Fine Handmade Confections

13 Forest Place • Plymouth
459-1990
OPEN 7 DAYS

CURIOUS
Child

11 Forest Place
Downtown Plymouth
455-4884

We specialize in books to help answer kids tough questions.

American Girl Parties
1st Friday of Every Month.

Special Holiday Hours between Thanksgiving & Christmas Eve

Sun., Mon., Tues. 11-5
Wed., Thurs., Fri. 10-9
Saturday 10-6

Aristoplay Games Nights
2nd Friday Every Month
Kids, Teens, Adults Welcome

Sorry, No Handicap Access to Game Room



BRASS & IRON
BEDS
of Plymouth

Michigan's Finest Beds
9 Styles Currently on Display

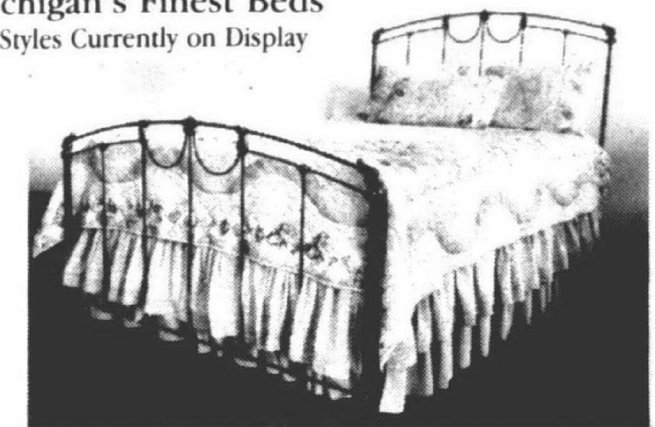

Our magnificent reproduction iron, gun metal, marbelized & brass beds use a cast steel interlocking frame system, NOT nuts and bolts. So, unlike flimsy imitations, our beds will never shake, rattle, roll or even loose a screw. Prices starting at \$499.

Gift Ideas:

- Vera Bradley Quilted Accessories & Clothing
- Glass Dimension Wax Lamps - Many Styles
- Picture Frames, Perfume Atomizers, Trinket Boxes
- Night Shirts - Robes
- Other Decorative Accessories

873 W. ANN ARBOR TRAIL, Downtown Plymouth

451-7181

OPEN: Tues.-Sat. 10-6; Fri. 10-8, Sun. 12-5; Closed Monday

Come discover a complete custom frame shop

Creative Framing & Fabric Accents

853 W. Ann Arbor Trail • 453-2810
In Downtown Plymouth, 1 Block W. of Main St.
Hours: Mon., Wed 10-7; Tues., Sat 10-6; Thurs., Fri 10-9; Sun 12-5

20% OFF
CUSTOM FRAMING
Expires 12-10-92

We Frame Just About Anything
"If it's worth keeping, it's worth framing"

WE WORK WITH OUR CUSTOMERS

- Over 2000 Frame Samples
- Large Selection of Posters & Limited Editions
- 100's of Mat Samples
- Framed & Unframed
- All Kinds of Mat Cuts
- Print Catalogs Available to Take Home

Come See Us At Our New Location

Distinctive Window Stylings, Custom Draperies, Curtains, Shades, Blinds and Accessories

Hundreds of Fabrics to Choose From
Everything for your windows plus...
Custom Bedspreads, Lampshades, Pillows & More
For an in-your-home consultation with a talented member of our decorative staff, call:

OPEN HOUSE HOLIDAY HAPPENING
SAT. NOV. 14H

Village Decor Flat
Window and wall treatments plus accessories

825 Penniman • Downtown Plymouth
Open Mon.-Fri. 10-6; Thurs. 10-8; Sat. 10-5

ValueMaster
MINI-MICRO BLINDS

Special Offer
50% OFF
Offer includes both mini & micro blinds.

Grace the table.

Bring a beautiful Teleflora bouquet to the Thanksgiving table. Autumn's most colorful flowers in a delightful gift. We can send one anywhere.



As Shown from \$29⁹⁵



The Bountiful Basket Bouquet

Teleflora

Heide's flowers & gifts

995 W. Ann Arbor Trail • 453-5140 • Plymouth, MI 48170

Daily 8:30-6:00 Saturday 9:00-5:00

Sending Warm Wishes
this Thanksgiving Season and
throughout the coming Holidays!

From Tom and the Staff

Delta Diamond
Setters
and Jewelers

Come and see our new expanded location!

895 W. Ann Arbor Trail
Plymouth
(at the corner of Forest Ave.)
455-1220

Holiday Hours
(11/27/92 to 12/23/92)
Monday thru Friday 10-8
Saturday 10-6 • Sunday 12-4
(Christmas Eve Day 10-4)

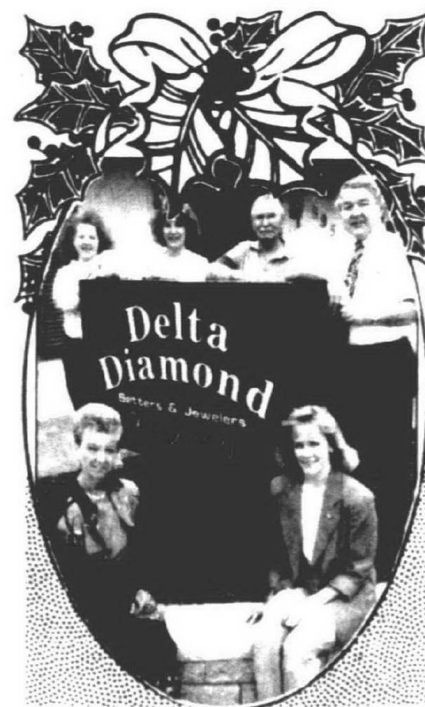

Back row: Debbie Lobb, Kathy Aschermann, Ted Pomroy, Tom Piotrowski
Front row: Eleanor Shevlin, Melinda Adducci, G.G.

Good's
NURSERY

Wreaths
Live Green & Artificial

Christmas Green
& Garland Roping

Poinsettias
& Christmas Cactus

Collectors
Santa Clauses & Angels
Plus Christmas Ornaments

Good's NURSERY INC.
51225 Ann Arbor Rd.
(at Napier, 8 miles from Ann Arbor)
453-2126

Mon.-Sat. 9-5:30
Sun. 11-5

Maggie & Me

Announcing...
the opening of our
New Royal Oak Store
at the corners of
Fourth and Washington
-and-
our **New Plymouth Location**
924 W. Ann Arbor Trail

Thanksgiving Sale
Friday and Saturday
Nov. 27th Nov. 28th
10-8 10-6
10% OFF Maggie & Me Label
20% OFF the rest
of merchandise

Christmas is coming...
Let us help you with your holiday shopping



10% OFF

With This Ad

ORDER NOW!

- Sausage, Canned Ham
- Coffee, Tea
- Cheese, Crackers
- Preserves, Mustards
- Sparkling Cider
- Bath Items
- ...and more!

- Shipping & Delivery Available
- Commercial Accounts Welcome
- Mastercard & Visa Accepted

Special Touch Gift Baskets

Call Today For Your Customized Gift

(313) 455-9471 or (313) 563-6892

Great Gift Idea!

IS IT JANUARY 1ST YET?

Are you going to start exercising Jan. 1st? Why wait...
GET STARTED TODAY!!!
50% OFF INITIATION FEE



PLYMOUTH FITNESS STUDIO

44511 Ann Arbor Road (Next to Big Boy) • 451-1165
M & W 6 a.m.-8:30 p.m., T & Th 8 a.m.-8:30 p.m., Fri 6 a.m.-8 p.m., Sat 8 a.m.-2 p.m., Sun 9 a.m.-1 p.m.

Karastain CARPET
LOW, LOW PRICES

HOLIDAY SPECIALS

UP TO **45% OFF**

Also Available:
• Wood Floors
• Ceramic Tiles

Brand Name Vinyl Floors
Trade Show Carpet Remnants Closeout Specials
Residential • Commercial

V.I.P. FLOOR COVERING LTD.

WAREHOUSE OUTLET
29155 Plymouth Rd.
E. of Middlebelt, Livonia
422-7130

Hours: 8:30-5:00 M-F
8:30-12:00 Sat.

24365 Halstead Rd.
(Just North of Grand River)
Farmington Hills
Hours: 9:30-4:00 M-S
5:30-7:00 Mon. & Thurs. Evenings
478-6606

Give A Holiday Gift
In A Basket

Let us take care of your business and personal gift giving.
Fruit • Pastry • Gourmet

Basket Kreations
Give the unexpected gift

451-5577

8521 Lilley Rd., Canton, MI 48187
Local Delivery/UPS



TORO CCR POWERLITE
NOW ONLY **\$359⁹⁵**

- Light and easy to use
- Clears up to 12 inches of snow - up to 25 feet away
- Model #38170

Start Feeding Now!
Enjoy Birds All Year!
Heath Redwood BIRD FEEDERS
\$15⁹⁹ to \$76⁹⁵

SAXTONS GARDEN CENTER, INC.
587 W. Ann Arbor Trail • Plymouth • 453-6250

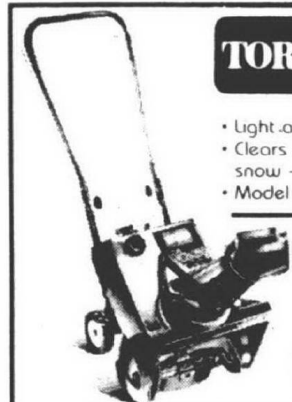

Christmas Gifts that Twinkle Bright



We want to make Christmas Shopping as easy as possible—and with our guarantee of satisfaction, it is. Select a beautiful gift of jewelry with absolute confidence!

O & D Bush Jewelers

481 Ann Arbor Trail • Plymouth • 455-3030
Between Lilley and Main



Extended Holiday Hours:

GIANT WATCH CLEARANCE SALE

All Watches Must Go! Make An Offer!

Free Battery in every new watch sold!



Pre-Christmas Sale Starts Today!

SEIKO

NOBLIA

CITIZEN

BULOVA

LASSALE
THE ART OF SEIKO

LONGINES

WITTNAUER

BENJAMIN'S LTD.

882 W. Ann Arbor Tr.
Downtown Plymouth

454-0888

- FREE LAYAWAY
- FINANCING AVAILABLE
- ALL CREDIT CARDS

MOST REPAIRS WHILE YOU WAIT

10-8 M-F
10-6 Sat
10-5 Sun

Bed 'n Stead
Fine Linens and Gifts for the Home

In case you have not been in our new store, we carry:

Holiday Table Linens	Collectable Bears
Kitchen & Bath Towels (monogramming available)	Aromatic Potpourri
Quilts & Afghans	Wreath & Wall Decor
Rubber Stamps & Supplies	Christmas Ornaments
Chair Pads & Pillows	Snow Babies & Nutcrackers
	Dedham Rabbit Pottery

Lizzie High Dolls

New...Ribbon & Custom Bows

470 Forest Ave., Plymouth, MI
(313) 455-7380

Mon., Tues., Wed., Sat. 10-6
Thurs. & Fri. 10-9 Sun. 12-5

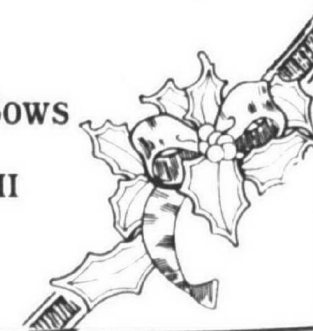

sunny j's
lingerie & leisure wear

GIFTS of LOVE in LINGERIE

Lingerie with a touch of class and personalized service to make your Holiday shopping a pleasant experience.

HOLIDAY HOURS:
MON.-FRI. 10-9
SAT. 10-6
SUN. 12-5

• 1992 Swimwear In Stock
• Bras & Body Suits for Holiday Dresses

Sizes Petite-4XL
32A-56DD 34E-48H

470 Forest, Plymouth, MI
(313) 453-8584
PROFESSIONAL BRA FITTERS

Remember... **MEN'S NIGHT**
Fri., Dec. 11th
6-9 P.M.

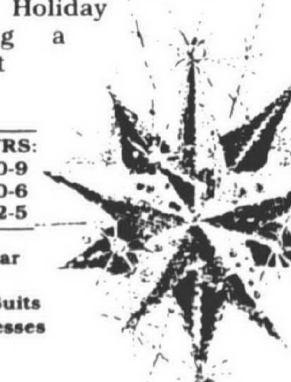

Santa's Favorite Chair
is now La-Z-Boy® Holiday Sale Priced

We've got plenty of recliners in exciting styles and fabrics that are now on sale and ready to be delivered in time for the Holidays.

PRICES STARTING AT **\$299**

Gift Certificates Available

Walker/Buzenberg
fine furniture

240 N. Main Street • PLYMOUTH • 459-1300
Mon., Thurs., Fri. 10-9 • Tues., Wed., Sat. 10-6
Michigan's Oldest La-Z-Boy Dealer

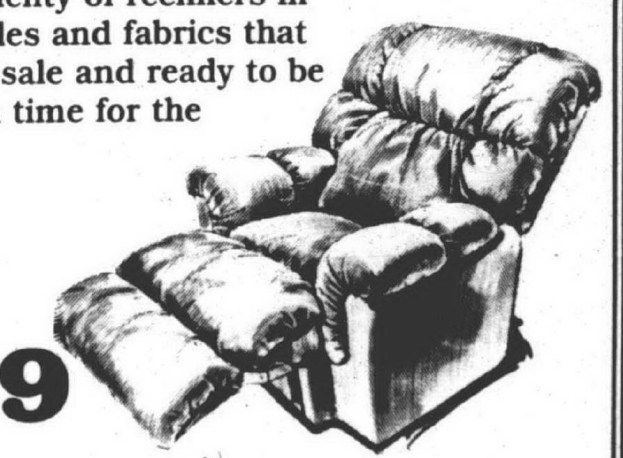

Merry Christmas & Happy New Year!!!

RYOBI SPECIAL POWER TOOLS

DS1000
Detail Sander

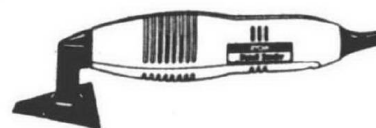

\$55⁹⁵

16" Scroll Saw
\$159⁷⁵

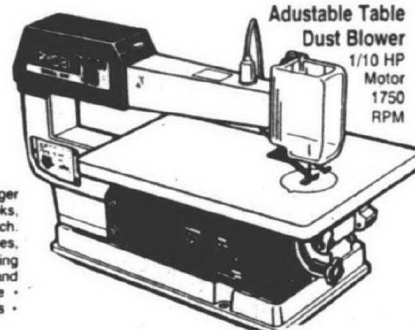

0-45°
Adjustable Table
Dust Blower
1/10 HP
Motor
1750
RPM

Ryobi gives you a new angle on details that makes finger sanding obsolete. The Detail Sander fits into nooks, corners and tight spots where other sanders can't reach. Its powerful oscillating action produces extra fine finishes, virtually eliminating finger sanding. The reusable Sanding Angles have sure-stick, self-adhesive backs for quick and easy changes. Use the Detail Sander for: Furniture - Picture Frames - Shutters - Stair Railings - Woodcrafts - Molding - and more!

POWER CARVERS SPECIAL MOTO-TOOL® KITS

FOREDOM



\$215⁰⁰
S Hang-Up
Style



\$78³⁶

#S-FCT 1/8 hp
44B hand piece
1/4 & 1/8 Collets

3950 Variable Speed
Moto-Tool Kit

Stocking Stuffer

CARVING SET
CHRISTMAS SALE!
WOOD CARVING CHISELS
Beginner's 6 piece Chisel Sets
Regular Price \$30⁰⁰

STRAIGHT
HANDLES
#151001
\$25⁷⁵

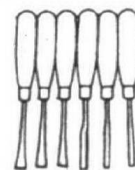

PALM
HANDLES
#151006
\$25⁷⁵

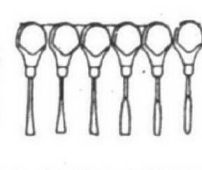

ALL CARVING TOOLS HONED AND READY TO USE

"BOOKS - 20% OFF"

Craftsman's Cove INC.

34712 Plymouth Rd.
Livonia, Mich. 48150
313-522-2708
EXP. 12-24-92

KIDS ASK FOR 'EM BY NAME!

And you'll ask for 'em because of the quality leather uppers and great fit. Many styles now available.

\$29⁹⁹

Serving your children since 1958
33426 W. 5 MILE - LIVONIA - 427-3477
(1 Block W. of Farmington Road)
Tues., Wed., Sat. 10-6
Mon., Thurs. & Fri. 10-8

YOUR YEAR ROUND CRAFT SHOW

CRAFTERS SHOWPLACE
HANDCRAFTED GIFTS FOR ALL YOUR HOLIDAY GIVING

Don't wait for the Weekend Craft Shows, We're Here For You All Week.

High Quality (313) 454-4717
43343 Joy Rd.
Canton, MI 48187
Great Prices

* Crafters Always Needed to Display!

The Plymouth Tux Shop

20% OFF HOLIDAY RENTALS

Wedding Special Groom's tux free when 5 or more in wedding party and 10% off rest of wedding party.

Come see us for our Prom & Wedding Specials

Located in Plymouth's Old Village
630 Starkweather - Plymouth 451-7931

Arnoldt Williams Music's 30th Anniversary Sale

ALL PIANOS...Grands, Uprights and Digitals
On Sale Thru The Holidays

YAMAHA Technics KAWAI

Special Prices on Select Demo Instruments
Tremendous Selection of Instruments for Holiday Gift Giving
Gift Certificates for Our "Fun With Music" Piano Lab Available at \$29.95

(313) 453-6586

5701 Canton Center Rd.
2 Miles West of I-275, 1 block North of Ford Rd. in Canton Township

Open Mon.-Thurs. 10 am-7:30 pm • Saturday 10 am-5 pm • Friday 10 am-6 pm

ARNOLDT WILLIAMS MUSIC INC.

Remember to shop at Rella Della's for unique & handcrafted gifts for all of the 'special someones' on your Christmas list.

Rella Della's
handcrafted gifts for your home and loved one.

Holiday Hours:
Tues. and Fri. 1-6
Wed. 10-9
Thurs. and Sat. 10-6

3019 S. Wayne Road, Wayne, MI 48184
(313) 728-8290

Ask about our 'Special Someone' program, gift registry, & gift wrapping.

Sew-Up Some Christmas Savings at **PLYMOUTH VAC AND SEWING CENTER** central vac & intercom

989 Ann Arbor Rd. Plymouth, MI 455-3500

Now, you can put the finishing touch on all your sewing projects faster and easier than ever with New Home's newest collection of MyLock Sergers. Each one has the quality and reliability you've come to expect from New Home.

Come in today and start serging. There's a new MyLock Serger in your future...
from **\$299**

NEW HOME®

- 9 popular stitch patterns, plus buttonhole!
- Color coded stitch selection!
- Auto-stop bobbin winder!
- Failsafe needle insertion!
- Free arm design!
- Convenient accessory storage compartment!
- Build-in carry handle!

Now As Low As **\$199**

GRAND RE-OPENING **20% OFF**

RIVER OAKS FURNITURE

CUSTOM DESIGNED WITH YOU IN MIND

CUSTOM DESIGNS IN SOLID OAK FOR HOME OR OFFICE

- Dining Tables and Chairs
- Entertainment/Wall Units
- Bedroom Pieces
- Desks, Bookcases, File Cabinets

47461 Clipper St. • Plymouth Twp. • Off Beck 1/4 Mile N. of M-14 • Next to New Post Office

416-1311

Hours: 10-5 Mon.-Fri. • 10-2 Sat. • Evenings by Appointment

The charm of Christmas past, the joy of Christmas presents!

Christmas Eve has arrived at last, and it's almost time for bed. But first, this youngster, perhaps imitating Mom and Dad, informs a very attentive doll that "You'd Better Not Pout!" - especially with Santa due any minute! This heartwarming version of Victorian childhood is just one of the many perfect gifts we have in stock for your selection.



"You'd Better Not Pout!"

Based on a Victorian Age illustration

© 1992 W. S. George
Issue price: \$29.50
Product I.D. #9221
Bradex No. 84-G20-102.1

MARION'S COLLECTIBLES

30206 Plymouth Rd., Livonia • 522-8620
Next to Sports Authority

Your Authorized Bradford Dealer

After Thanksgiving
Mon-Sat 10-9, Sun. 12-5



Your One-Stop Christmas Shop
OPEN NOV. 27th

QUALITY POINSETTIAS
4, 6, 8 and 10 inch pots
\$3.49 and up

WREATHS
from 10" to 36"
• Balsam • Mixed Balsam
• Noble Fir • Douglas Fir

ROPING
• Cedar • White Pine
• Oxford Cedar

GRAVE BLANKETS
\$19.95 and up

FRESH CUT CHRISTMAS TREES
• Douglas Fir • Scotch Pine
• Fraser Fir
• Colorado Blue Spruce

VALUABLE COUPON
\$2.00 off CHRISTMAS TREES
\$1.00 off GRAVE BLANKETS
made to order
50% off POINSETTIA
6" and up

CLYDE SMITH & SONS
GREENHOUSES
8300 NEWBURN RD. OF JOY RD. • 425-1434
OPEN 7 DAYS

Critter Country
WILD BIRD SUPPLY & NATURE GIFT SHOPS

- BIRD SEED
- BIRD FEEDERS
- BINOCULARS
- FIELD GUIDES
- SQUIRREL BAFFLES
- WOOD CARVINGS
- CATHERINE McCLUNG NOTE CARDS
- GWEN FROSTIC STATIONARY
- DECORATIVE BASKETS AND BIRD HOUSES
- COFFEE MUGS, VASES, MUSIC BOXES
- BALSAM WOOD POTPOURRI
- NATURE PRINT DOORMATS

Droll Yankee's PRODUCTS

Black-Oil Sunflower Seeds
50 lbs...only **\$12.95**

FREE...
Audubon Society "Check-List" of North American birds with purchase of any bird feeder

Critter Country
PLYMOUTH 640 Starkweather (313) 455-4144
ANN ARBOR 3374 Washenaw Ave. (313) 973-0066

Aunt Clara's Cookies & Muffins
Lunches & Carryout

Aunt Clara's Carries
croissant sandwiches, soup & pasties.

DELICIOUS SELECTION OF GOODIES...

- Cookies
- Coffee Beans
- Muffins
- Brownies
- Party Trays
- Gift Baskets
- Shipping Avail.
- Gift Certificates
- Veggie Muffins

960 W. Ann Arbor Tr. Suite 3 Plymouth, MI 48170
455-8338

Next to McAuley Health Center

SANTA SURPLUS
TOY & GIFT OUTLET STORE
We're The Holiday Discount Store

specializing in overstocks, closeouts and discontinued lines - many of them name brands. We're locally operated and we're here from now until Christmas.

CANADIAN PINE GARLAND
Flame Resistant Plastic. Retail Value \$5.99
\$2.49

BIRDS & BERRIES WREATH.
Three red birds nestle on a grapevine wreath with bright berries, artificial pine and Christmas ribbon. Hang it inside or outside. 16" diam.
\$9.99
Retail Value \$27.99

HAPPY BEARS TREE SKIRT
3 cute bears on a festive poly cotton cloth await the gifts under your tree! Satin ribbon tie. 35" diam.
Retail Value \$17.90
\$7.99

HOLIDAY HORSE SPECIAL
Surrounded by Christmas goodies, the wind-up painted horse plays "Jingle Bells" 7 1/2".
Retail Value \$24.90
\$7.99

SANTA'S SURPLUS
Westland Crossing (corner of Wayne & Warren Roads)
WESTLAND
Hours: 10 to 9 pm - Mon.-Sat.
12 to 5 pm - Sunday

Ribar Floral Co.

You're invited to enjoy the sights, sounds & fragrance of the Holiday season.
Nov. 27 & 28 at 6:00

Select from our many original fresh & permanent-Christmas designs, wreaths, arrangements & blooming plants.
Refreshments

728 South Main • Plymouth, MI 48170
455-8722

HOLIDAY MONEY

Advice You Can Trust

Specialty PET SUPPLIES

Complete Holiday Shopping For That Special Pet

- Stockings & Stocking Stuffers
- Latex Toys
- Rawhide Toys
- Catnip Toys
- Large Selection Coats & Sweaters
- Gifts For Dogs, Cats, Birds, Hamsters

Minimum \$5 Purchase
Excludes Pet Foods
Expires 12-31-92

FREE GIFTS PLUS FREE SAMPLES OF DOG & CAT FOOD

HOURS:
Monday thru Friday 10-8:00
Sat. 10-7, Sun. 12-5
(313) 453-6930

1498 S. Sheldon, Plymouth, MI (Corner of Ann Arbor Road)

Everything For Pets
5000 Square Feet Of Pet Shopping

Not Legal Tender **ONE DOLLAR VALUE** Not Legal Tender

The Best Just Got Twice As Good!

FREE EXTRA SET OF PRINTS EVERYDAY

Now Thru Dec. 31st
The Best Place for Better Pictures...

Guaranteed
Each print will be the best it can be or we'll reprint it free...now!

"When you order a complete second set of prints at roll processing. Extended time of original service may apply. Club members may choose to receive a Free Extra Set plus get 10% off processing in place of regular Club options. Ask about our CLUB PLUS PLAN. MANY SAVINGS!"

UP TO \$5.00 OFF ON FILM PROCESSING
With this coupon, save up to \$5.00 on processing and printing one roll of color print film (C-41 process) at One Hour Motophoto. Get \$5.00 off on 36 exp. or \$3.00 off on 24 exp. or \$1.00 off on 12 exp. 35MM & 110 Only

REPRINTS 29¢ EACH
With this coupon, bring in as many as 50 of your favorite color negatives and receive the special reprint price of only 29¢ each.

ONE HOUR MOTOPHOTO
The best place for better pictures... guaranteed!

Wonderland Mall (in Big Boy Corridor)
422-9310

Featuring American And Italian Cuisine

Located east of I-275 on Ann Arbor Rd. Plymouth, MI 48170
(313) 454-1444

"FAMILY VALUES"
THE ITALIAN CUCINA WILL DO ITS PART!

Beginning Sunday, Nov. 1st and every Sunday thereafter
All children 10 yrs. of age & under will eat FREE!
(Ordering from the Children's Menu between 12 noon and 4 p.m.)
Take the family out to Sunday dinner without spending the entire grocery budget!

See us for your **Christmas Party Plans**
Full Banquet Facilities Available

Italian Cucina
39500 Ann Arbor Road
Plymouth, Michigan (Just East of I-275)
454-1444

HAPPY THANKSGIVING

The Italian Cucina will be closed on Thanksgiving Day so that our employees may spend the holiday with their families. We wish to take this opportunity to thank you for your patronage and to wish you and your families the Happiest of Thanksgivings.

SOLID OAK

15 YEAR WARRANTY

A Lifetime Of Dining...

with the handsome pedestal table and matching bow back chairs it comes with a "15 year" warranty and is protected with RESISTOVAR® II, a finish BUILT FOR LIFE!
The highest quality in Solid Oak Dining is enhanced by the design of this spectacular double pedestal table with four self-storing leaves which extend to 114 inches - ample seating for twelve.

Includes **TABLE and 4 CHAIRS**
\$1099

RESISTOVAR® II by UFB Coatings, Inc.

The finish on your Solid Oak Treasures will stand up to:
• Wood Alcohol • Citric Acid
• Nail Polish Remover • Ink • Lacquer Thinner
• Acetone and Much More!

Country Charm And Convenience

Backed by a "15 year" warranty and protected with RESISTOVAR® II a finish BUILT FOR LIFE!
The highest quality in Solid Oak Dining is enhanced by the design of this spectacular double pedestal table with four self-storing leaves which extend to 114 inches - ample seating for twelve.

Includes **TABLE and 6 CHAIRS**
\$2199
Reg. \$2399

TEMPERLEY'S
CHERRY and OAK FURNITURE

6100 PLYMOUTH ROAD • 421-6070
1000 W. WASHINGTON • 421-1000
1000 W. MICHIGAN AVE. • 421-1000

Plymouth Jewelry & Gifts

Celebrating our 5th Anniversary Sale

ALL IN-STOCK MERCHANDISE* 50% OFF

This Special Anniversary Sale Includes:

- Diamonds
- Rings
- Watches
- Bridal Jewelry
- Wedding Bands
- Pearls
- Charms
- Bracelets
- Necklaces

That's right... EVERYTHING IS 50% OFF!

No-charge lay-a-way available now 'til Christmas
All major credit cards accepted

EXTENDED HOLIDAY HOURS STARTING NOV. 27th
Mon.-Sat. 10-8 Sun. 12-5

620 Starkweather • Plymouth • 453-1860

*Excluding watch bands and Colibri merchandise.

MAKE YOUR CHRISTMAS A JOYOUS ONE... JOIN OUR CHRISTMAS CLUB TODAY

At any moment, for any reason, the joy of giving is timeless. It warms the heart and brightens the spirit!

And right now is the perfect time to start saving for Christmas 1993. By starting early, it's easy to build up a special savings that will be available to you in plenty of time for holiday shopping.

Please ask about our Christmas Club at your nearest Community Federal office.



500 S. Harvey • Plymouth • 453-1200
44570 Ford Road • Canton • 455-0400
400 E. Main Street • Northville • 348-2920

Accounts federally insured to \$100,000 by the NCUA, an agency of the US government. Equal Housing Lender.

Parkway Professional Grooming
We offer: ALL BREED DOG & CAT GROOMING
Veterinarian strength flea baths & dips
Specialists In: BICHON FRISE
POODLES (TOY, MINIS & STANDARDS) SHIH-TZU
Our groomers offer 20 years experience in the Pet Profession.
Breeders of Quality Bichon Frise
We are your Pet Care Specialist
For Your Appointment Call 453-9488
Located directly adjacent to Parkway Veterinary Clinic

STEVE PETIX CLOTHIER
The Best Kept Secret In Michigan!
If you enjoy courteous sales help, quality merchandise, expert alterations...you'll appreciate Steve Petix, the complete men's store.
CLOTHING • SHOES • ACCESSORIES
OUTERWEAR • FORMAL WEAR
STEVE PETIX CLOTHIER
340 S. Main St. Plymouth, MI 48170 (313) 459-6972
HOURS: Mon. & Thurs. 10-8
Tues.-Wed.-Fri. 10-6
Sat. 10-5:30

Like "One-of-a-Kind" decorating?
It's all at Warren's Country Corner - the "home-gift" store with a country flavor.
Stoneware, Pottery, Large Selection of Yankee Jar Candles, Quilts, Coverlets, Finely Crafted Furniture, Gifts
Warren's Country Corner
Gifts, Furniture & Accessories
23285 Farmington Rd. • Downtown Farmington • 478-1259

Put the livonia family under your Christmas Tree!
Ask about our surprize gift for new adult and family members (Dec. 1-Dec. 21) A \$25 Value!
Call 261-2161 for more information.
Racquetball, Basketball, Wellness Center, Swimming, Fitness, Tennis
livonia family
The YMCA - A Great Family Gift
14255 STARK ROAD • LIVONIA • 261-2161

CHILDREN'S ORCHARD
In Preparation For Our Grand Opening We Are Pleased to Offer
CASH
A 10% Bonus will be given with this ad for your childrens outgrown clothing, accessories and toys!
Call Today For Your Appointment (313) 453-4811
THE BEST RESALE SHOPS IN THE COUNTRY!
Coventry Commons Shopping Center
Joy Road & Main Street, Canton
Near Farmer Jack's

Emily's World TRAVEL, LTD.
"We Want To Be Your Travel Agent"
• Airline Tickets
• Tours
• Rail
• Cruise DISCOUNTS
Over 20 Years Experience No Service Charge
708 S. Main St. Plymouth
455-5744

Hobbies are Family Fun
Hobby House
Complete Selection of RC Boats Cars Planes
Layaway Available
M T W TH F 10-8
Sat. 10-6 Sun. 12-5
8208 Merriman Rd. (Near Ann Arbor Trail)
Westland 425-9720

MOTO-TOOL KIT
Retail \$117.50
\$69.95
Dremel 5950 Variable Speed with Case and Accessories

X-ACTO KNIFE CHEST - Boxed
Retail \$17.95
\$12.99
Excellent Gift Idea
X-ACTO 5070

LATINA BLUENOSE WEEKEND KIT
Retail \$31.99
\$24.95
LATB1700 Wood Model with Great Detail. Popular Sailing Ship.

QUEST TRACER ROCKET STARTER SET
Retail \$21.99
\$15.99
QUEST 5300 Perfect for Beginners

BACHMANN OLD TIMER SETS-HO
Retail \$86.50
YOUR CHOICE \$49.99
Great for Christmas Village Many Other Sets Available

COUPON PAASCHE AIRBRUSH
Retail \$64.00
PASR 2130 \$39.99
Great Airbrush for Painting T-Shirts, Models, Ceramics, and more. Fun and Easy to Use.
Coupon Expires 12-24-92

COUPON MAKIT & BAKIT SUN CATCHERS
\$1.99 ea.
Limit 2 • Coupon Expires 12-24-92

COUPON MICKEY MOUSE CHRISTMAS SUN CATCHERS
Value \$4.50
\$2.99 ea.
Paint Them and Hang Them. Creative Family Fun.
Coupon Expires 12-24-92

THE NOVI HILTON. HOME FOR THE HOLIDAYS.
THE BIG CHILL \$89.00 Package includes Family Fun Pack upon arrival. Free in-room movie. Breakfast & dinner for the kids. Breakfast for the parents. A great weekend getaway.
ROMANCE PACKAGE \$89.00 A bottle of champagne and chocolate covered strawberries upon arrival. Deluxe room accommodations. Turn down service with a rose. A basket of bath soaps. Breakfast in bed. Treat yourself to a romantic weekend.
NEW YEAR'S EVE \$140.00 per person. Based on Double Occupancy. December 31, 1992. Includes 4 course gourmet dinner, 8 drink tickets per person, champagne toast at midnight, party favors, overnight stay, New Year's Day Brunch Buffet.
DINNER PACKAGE \$89.00 - Good Friday, Saturday and Sunday. Deluxe room accommodations & \$20 in Hilton Money for Restaurant & Lounge. A Great Gift.
The Novi Hilton extends warm wishes for the holidays. We're ready to make the season festive and enjoyable for your family, friends, guests and yourself with these HOME FOR THE HOLIDAYS packages!
CALL (313)349-4000 FOR INFORMATION AND RESERVATIONS
21111 Haggerty, I-275 & 8 Mile, Novi, MI. 48375

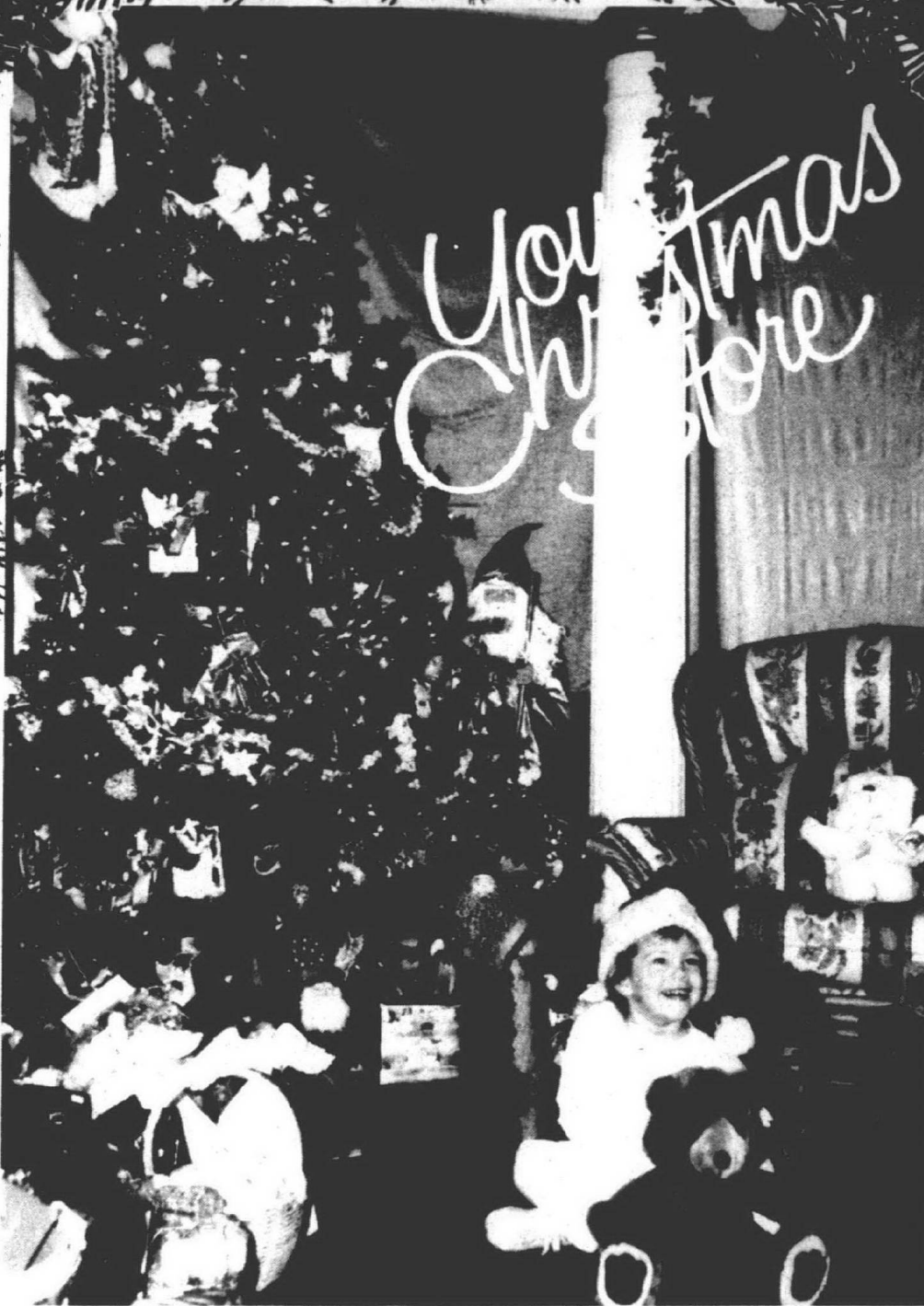

Choose from over 50 different styles of natural looking trees.

Fantastic light selection - "indoor & outdoor."

Department 56 villages.

Hundreds of tree trims.

Fontanini Nativities Sets.

Unique gifts.

Wreaths & garland.

HOURS

Weekdays 10-8:30

Saturday 10-6:00

Sunday 12-5:00

Closed Wednesday



COUPON
Christmas Light Trade-In

For every set of old lights you bring in, receive \$1.00 credit towards the purchase of a new set of lights.

Expires Dec. 1, 1992

CORNWELL
Christmas World

CORNWELL
pool & patio

874 W. Ann Arbor Road
Plymouth
459-7410



**SAVE
WITH THE
COUCH POTATO'S
GIFT GUIDE
SEE PAGE 9**

drapery boutique
Since 1947
Custom Draperies
50%
OFF

See pages 20-21

Michael Tucker and Jill Elkenberry star in the NBC movie *A Town Torn Apart*, airing Monday, Nov. 30.

The Plymouth-Canton Observer/Northville Record

CABLE/TV WEEKLY

- Matched to Your Cable Channels • Local Access Programming
- Weekly Cable Listings Plus Network Programming

HOROSCOPE

By C.C. Clark

SAGITTARIUS (Nov. 22 - Dec. 21)
A young man in your life needs constant motivation; otherwise his talents could be wasted. There is much happiness in your near future.

CAPRICORN (Dec. 22 - Jan. 19)
You may be expecting too much from yourself and those around you. Keep your temper when dealing with someone with a defensive attitude.

AQUARIUS (Jan. 20 - Feb. 18)
You have two paths to choose from, and the one you take could affect the rest of your life. Stick to what you know is true and don't be tempted by anything else.

PISCES (Feb. 19 - March 20)
Your stubbornness could hinder your chances of meeting someone new. There is a lesson to be learned from this situation.

ARIES (March 21 - April 19)
Things may seem unpleasant now, but they are going to get better. This is a good time to plan a trip to get away from it all.

TAURUS (April 20 - May 20)
There is a good chance there will be a rewarding exchange of ideas between you and a close friend. Use your intuition in handling a certain situation.

GEMINI (May 21 - June 20)
You may feel that life is at a standstill, but you are ready to get things moving again. Start making plans for the future and get yourself motivated.

CANCER (June 21 - July 22)
Life is going to get easier for you, and it is about time! Exciting events are in store for you. Life works in cycles, and this is a positive one for you.

LEO (July 23 - Aug. 22)
There is an indication you will receive a message concerning a close friend or relative. Someone knowledgeable could give you the help you need.

VIRGO (Aug. 23 - Sept. 22)
You will be surprised at how great you feel just by changing your attitude. You will meet someone who is kind and sympathetic.

LIBRA (Sept. 23 - Oct. 22)
It is important for you to remember that it is never too late to make amends. You should right a terrible wrong you have committed or face the consequences.

SCORPIO (Oct. 23 - Nov. 21)
You want the best of both worlds, but reality dictates compromise on your part. Quarrels could cause a severe break in a relationship.

★ LEGEND ★

Start Listing	Mon, November 23	6:00 am
End Listing	Mon, November 30	6:00 am
Show Types	LIVE SPORTS MOVIES	
NETWORK	SERIES SPECIALS MISC	
SPORTS		
Channel	Station	City
3	MTV	Music
4	CNNII	
6	TWC	Weather Channel
8	VH-1	Video Hits 1
9	ESPN	Sports
10	PASS	Ann Arbor Classics
11	AMC	Flint
12	WFUM	Family Premium
13	FAM	Premium
14	MAX	Premium
15	TMC	Southfield
16	HBO	Detroit
17	WJBK	Southfield
18	WDIV	Detroit
19	WXYZ	Southfield
20	CBET	Windsor
21	WKBD	Southfield
22	WTVS	Detroit
23	WGPR	Detroit
24	WXON	Southfield
25	WGN	Chicago
26	TBS	Atlanta
27	SCI	New York
28	LIFE	Lifetime
29	NICK	Nickelodeon
30	USA	New York
31	CNN	News
32	A&E	New York
33	CNBC	Finance
34	TNN	Nashville
35	TNT	Atlanta
36	TLC	Learning Ch.
37	BET	Black Ent.
38	CSPAN	Government
39	DISC	Discovery
40	SHOW	Premium
41	DISN	Premium

OMNICOM CABLEVISION

TO ORDER CABLE TV
CALL: 459-7300

Princeton Court Apartments



CALL FOR SPECIALS

459-6640

14251 Princeton Drive
Plymouth

WE'LL HELP YOU SET THE TABLE.

Send the FTD® Autumn Harvest Bouquet. Just call or visit us today. Thanksgiving is Thursday, November 26.



\$29.95

It's as easy as FTD®



Delivery Available
Major Credit Cards Accepted

995 W. Ann Arbor Trail, Plymouth
453-5140 or Fax 453-0633

Phone orders accepted 24 hours a day, 7 days a week

FANTASTIC VALUES



Yellow Gold Genuine Stone Rings
Choose From Blue Topaz, Opal, Garnet, Amethyst & More!

O & D Bush Jewelers

Lay-A-Way Available
481 Ann Arbor Trail
Between Lilley & Main
Plymouth - 455-3030

Word Search on page 35

PRACTICE YOUR SWING BEFORE THE SNOW MELTS! AT THE GOLF INDOOR TRAINING CENTER



- Beginners Welcome
- On Site Pro
- Computerized Analysis
- Full Swing Drivers
- Chip Shots
- Sand Traps
- Golf Aerobics
- And Much More

Bring this ad in and get 10% discount on membership, pro-shop items, and club repair.

CALL FOR INFORMATION

(313) 380-6400

42277 W. 7 MILE RD,
NORTHVILLE

This Cable Guide Is Different... IT'S FREE!

With a Subscription To Your Favorite Local Newspaper

Plus, we match our listings to **YOUR** Cable Channels. Try finding another TV book that does all that.

Bring Us Into Your Home.
If you live in:

Plymouth or Canton
Call: 591-0500

Northville
Call: 349-3627

TAKE THE GUESSWORK OUT OF LOCAL CABLE ACCESS- READ YOUR ONE-AND-ONLY

CABLE/TV WEEKLY

Tucker plays can-do principal in 'A Town Torn Apart'

'Doc' Littky offers paradigm for success

Michael Tucker is excited about his latest TV movie, *A Town Torn Apart*, but he's afraid it won't get the attention it deserves.

Airing Monday, Nov. 30, on NBC, just a day after the books close on the networks' "sweeps" ratings slugfest, *Town* offers neither gunfire nor glamour, the usual commodities peddled by the network publicity machine. Instead, the movie dramatizes the true story of how a high-school principal turned his school around and the unorthodox methods he used to achieve his results.

The premise was such a long shot, Tucker says, that his friend and co-producer David Rintels initially warned him, "I don't think we can get a network sale on this." But NBC's entertainment chief, Warren Littlefield, was apparently swept along on the tide of the *L.A. Law* co-star's enthusiasm, and he made *A Town Torn Apart* the anchor of the network's "The More You Know" education and public-service week.

In the drama, Tucker plays

Dennis Littky, a doctor of psychology and Long Island school principal who left his career in education and moved to a small New Hampshire town, where he became the editor of the local newspaper. He lived in a primitive log house outside town with a pretty cellist who wasn't his wife, and the townsfolk viewed him with suspicion.

As the movie opens, Littky becomes aware of serious problems at Winchester's Thayer High, which is smeared with graffiti, crippled by violence and sinking fast. At Thayer High, kids don't expect to graduate, much less go on to college. To everyone's surprise, Littky produces his credentials and applies for the job of principal.

Littky works all summer to transform the appearance of the school using paint and supplies donated by parents after the first of many Littky pep talks. His strategy is to encourage the students to take pride in their school and to reach out to each individual in an effort to ignite a passion for learning. He

eliminates study hall, sends students into town to take part-time jobs that will teach them math and science and sets up small groups mentored by faculty members to make sure the students have a network of emotional and academic support. He even persuades one teacher (Jill Eikenberry) to take on the challenge of tutoring a special class of slow readers in an off-campus location.

Littky's proposals are unsettling, but he quickly wins over both students and teachers. Parents are another matter. Despite the success of Littky's methods (test scores are rising, and students frequently stay at school during the evening to work on class projects), a group of traditional-minded citizens takes umbrage and tries to block Littky's return for a second year at Thayer.

The movie chugs along as indefatigably as Tucker's "Doc" and provides several emotional highs, but best of which is the unveiling (filmed at the real Thayer High) of a mural painted by a drop-out student during Littky's first summer. These moments make up for a certain sappiness in the script, and the overall effect should inspire any leader, educator or not, to keep trying, no matter what the odds.

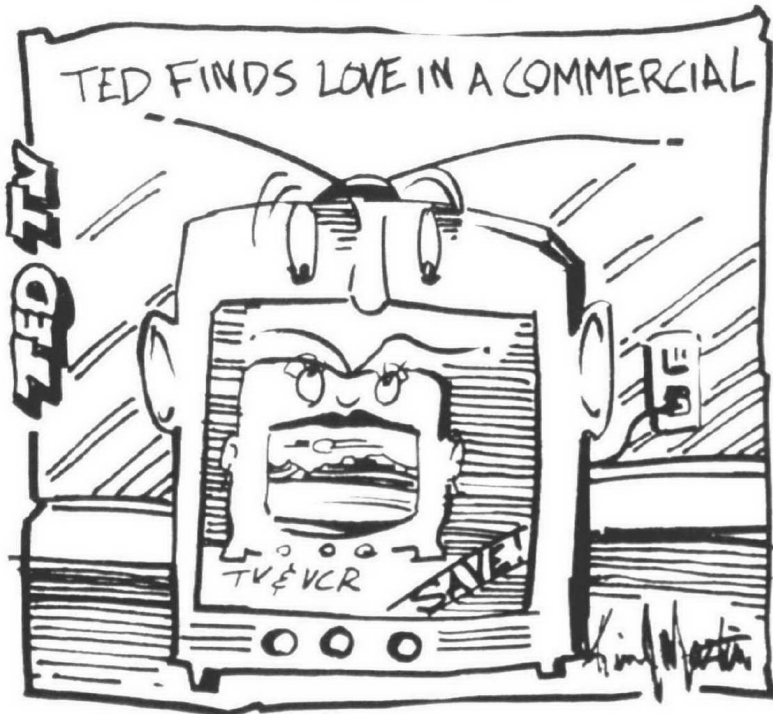

Leave a clean trail.

MONDAY AFTERNOON NOVEMBER 23

© 1992 TV Listing Inc. Ft. Worth, TX

	12 PM	12:30	1 PM	1:30	2 PM	2:30	3 PM	3:30	4 PM	4:30	5 PM	5:30
WFUM 15 28	Mr. Rogers	Lamb Chop	Art of Sewing	Jenkins Art	Sewing	Shining Time	Mr. Rogers	Sesame Street	Reading Rainbow	Sandiego?	Square One TV	
WJBK 13 2	News	Young and the Restless		Beautiful	As the World Turns	Guiding Light		News	News	Donahue		
WDIV 25 4	News	Cosby Show	Days of Our Lives		Another World	Montel Williams		Sally Jessy Raphael		News		
WXYZ 33 7	News	Loving	All My Children		One Life to Live	General Hospital		Oprah Winfrey		News		
CBET 15 9	Midday		Country Practice		Coronation Street	Neigh	Bill	Babar	Video Hits	Fame		5:30 Live!
WKBD 30 50	That's Amore	Andy Griffith	Little House on the Prairie		Bewitched	Alvin	Merry Melody	Jerry Kids	Tiny Toons	Batman	Saved by the Bell	Growing Pains
WTWS 17 58	Frugal Gourmet	Quit in a Day	Reading Rainbow	Sandiego?	Sesame Street	Barney & Friends	Reading Rainbow	Square One TV	Club Connect	Sandiego?	Life Matters	
WGPR 13 62	Robert Tilton		Ben Casey		Lou Grant		Santa Barbara	Movie: Rendezvous Hotel	E. Winter	B. Daily		
WXON 19 20	Designing Women	Hill Street Blues		Aurwolf	Camp Candy	Chip & Dale	Tale Spin	Darkwing Duck	Goof Troop	Different World	Different World	
MTV 2	Classic MTV		Big Picture	MTV Rocks			MTV Blocks	Pick a Fight With MTV		Totally Different Pauly		
CNNII 3	CNN Headline News						CNN Headline News					
TWC 4	(12:20) Bus	(12:40) Wthr	(20) Bus	(140) Wthr	(20) Bus	(140) Wthr	(20) Bus	(140) Wthr	(20) Bus	(140) Wthr	(20) Bus	(140) Travel
VH-1 5	(10:00) VH-1 Jam		VH-1 Jam				Top 10 Madonna Videos	This is VH-1 Country		VH-1 Block Party		
ESPN 6	Bodies in Motion	Body Shaping	Offshore Powerboat Racing		Golf: Taiheyo Club Masters, 3rd round (T)		Global Supercard Wrestling		NTPA Pulis	Sports Reporters		(45) Guide
PASS 7	Off Air											
AMC 9	(11:45) Movie: Highways by Night	This Is Your Life	Movie: Everything Happens at Night	R. Millard, S. Henie	Movie: Bedlam	B. Karloff, A. Lee	This Is Your Life	Movie: Enchanted Cottage	D. McGuire			
FAM 14	(11:30) Paid Program	Bonanza	Father Knows Best	My Three Sons	Incredible Animal Hour	ProStars	WishKid	Popeye	Inspector Gadget			
MAX 17	Movie: My Father's Glory	P. Caubere	Movie: Comancheros	J. Wayne, S. Whitman	Movie: Ocean's Eleven	F. Sinatra, D. Martin						
TMC 19	Movie: Return of Joe Forrester	L. Bridges, D. Stockwell	Movie: Once Around	R. Dreyfuss, H. Hunter	Movie: Repossessed	L. Blair, L. Nielsen (PG13)	Movie: Apartment	J. Lemmon				
HBO 21	(11:00) Movie: Butcher's Wife	(PG13)	Movie: Diving In	M. Adler, B. Young (PG13)	Movie: Elephant Man	A. Hopkins, J. Hurt	Life: Stones	Movie: Strictly Business	J. C. Phillips			
WGN 30	Geraldo	News	Andy Griffith	Honey-mooners	Designing Women	Saved by the Bell	Three Stooges	COPS	Flint-stones	Captain N		
TBS 31	(05) Perry Mason	(05) Movie: ... tick ... tick ... tick	J. Brown	(05) Jerry	(35) Flint-stones	(05) Jetsons	(35) Brady Bunch	(05) Saved	(35) Happy			
SCI 32	Dr. Who	Lost in Space	Voyage to the Bottom of the Sea	Movie: Supernatural	C. Lombard, R. Scott	One Step Beyond	One Step Beyond	Incredible Hulk				
LIFE 33	Frugal Gourmet	Shop 'Til You Drop	Super-market	Born Lucky	China Beach	thirtysomething	Movie: Celebration Family	S. Zimbalist				
NICK 34	Elephant	White Seal	Noozles	Littl' Bits	Muppet Babes	Dennis the Menace	Flipper	Looney Tunes	Underdog	Yogi	Nick Arcade	Hey Dude
USA 35	Judge	Judge	Supenor Court	Supenor Court	Sale/Century	Win, Lose or Draw	Hollywood Squares	Scrabble	\$25,000 Pyramid	Press Your Luck	Cartoon Express	
CNN 36	NewsHour		Sonya Live		NewsDay	International Hour	EarlyPrime	Politics 92	EarlyPrime	ShowBiz Today		
A&E 37	DelVecchio		Rockford Files		Movie: When Michael Calls	M. Douglas, B. Gazzara	Disasters	Fugitive		Ellery Queen		
CNBC 38	(11:00) Money Wheel				Money Wheel			Market Wrap Up				
TNN 39	Cookin' USA	Country Kitchen	Crook and Chase		Be a Star	Top Card	Cookin' USA	On Stage	Club Dance	Be a Star	VideoPM	
TNT 41	Girl From U.N.C.L.E.	Movie: Devil Commands	B. Karloff	(25) Movie: Man With Nine Lives	B. Karloff, R. Pryor	Movie: Run of the Arrow	R. Steiger, S. Montiel					
TLC 42	Traveler's Journal	Hometime	Antiques		Yan Can Cook	So Cooking	Madeleine Cooks	Cooking	Renovation Zone	Do It Yourself	Yan Can Cook	So Cooking
BET 43	(11:30) Heart & Soul R & B	Video Soul				Video Vibrations		Rap City				
CSPAN 44	U.S. House of Representatives					U.S. House of Representatives						
DISC 45	Easy Does It	Home works	Pasquale	Great Chefs	Gourmet	Graham Kerr	Easy Does It	Home works	Rand McNally Videotips	Beyond 2000		
SHOW 48	(11:25) Movie: Words and Music	M. Rooney, T. Drake	Movie: Three Wishes for Jamie	J. Warden, S. Rinkus	(05) Super Dave	Movie: Knute Rockne, All American	P. D. Brien, G. Page			Malibu (Pt. 1 of 2)		
DISN 49	Walt Disney Presents	Movie: Here Come the Littles	(G)	Pony Tales	Fraggle Rock	Wonderland	Jump, Rattle	Quack Attack	Kids Inc.	Mickey Mouse		

LOCAL PROGRAMMING - Monday Afternoon

- 3:00 8 Plym Music Celebration
- 15 Pharmaceutical Ed Networks
- 4:00 8 The First Thanksgiving
- 15 On stage TV
- 4:30 8 Canton Economic Club
- 15 Political Chronicles
- 5:30 8 Detroit Economic Club
- 15 Videotunes

MONDAY PRIME TIME NOVEMBER 23

Table with columns for time slots (6 PM to 10:30 PM) and rows for various TV channels (MTV, CNN, VH-1, ESPN, PASS, AMC, FAM, MAX, TMC, HBO, WGN, TBS, SCI, LIFE, NICK, USA, CNN, A&E, CNBC, TNN, TNT, TLC, BET, CSPAN, DISC, SHOW, DISN) listing their respective programs.

MONDAY PRIME TIME NOVEMBER 23

Table with columns for time slots (6 PM to 10:30 PM) and rows for various TV channels (WFUM, WJKB, WDIV, WXYZ, CBET, WKBD, WTVS, WGN, WXON) listing their respective programs.

LOCAL PROGRAMMING - Monday Evening

Table listing local programming events for Monday evening, including 'Our Lady of the Roses', 'Microwave Today', 'The Way, The Truth', 'Northville Folk & Bluegrass', 'Canton Bd. of Trustees', 'Life Matters', 'Beyond the Moon', 'Curbside Recycling', 'Plym. Canton Chieftees', 'Scenes of Yesteryear', and 'Far East Tradition'.

Table with columns for time slots (11 PM to 2:30 AM) and rows for various TV channels (MTV, CNN, TWC, VH-1, ESPN, PASS, AMC, WFUM, FAM, MAX, TMC, HBO, WJKB, WDIV, WXYZ, CBET, WKBD, WTVS, WGN, WXON, TBS, SCI, LIFE, NICK, USA, CNN, A&E, CNBC, TNN, TNT, TLC, BET, CSPAN, DISC, SHOW, DISN) listing their respective programs.

TUESDAY PRIME TIME NOVEMBER 24

Table of TV programming for Tuesday, November 24, 1992, from 6 PM to 10:30 PM. Includes channels like MTV, CNN, ESPN, AMC, and HBO with program titles and descriptions.

TUESDAY PRIME TIME NOVEMBER 24

Table of TV programming for Tuesday, November 24, 1992, from 6 PM to 10:30 PM. Includes channels like WFUM, WJBK, WDIV, WXYZ, CBET, WKBD, WTVS, WGPR, and WXON with program titles and descriptions.

LOCAL PROGRAMMING - Tuesday Evening

Summary of local programming for Tuesday evening, including times and program titles like 'Amvets Story Continues', 'Omnicom Sports', and 'Word for Today'.

Detailed table of local programming for Tuesday evening, listing channels, times, and program titles such as 'Alternative Nation', 'Good Evening Forecast', and 'Blue Desert'.

LET'S TALK

Extracurricular activities; reader caught Cab in '34

By Taylor Michaels

Q: I saw an actor I liked in a recent movie on television, but now I can't remember his name. The movie was Murder in New Hampshire. He was the man with the blond hair who killed the wife's husband and had an affair with her. Can you tell me what his name is?

—Shawna Greene, Deep Gap, N.C.

A: Chad Allen was the young man who played the student willing to kill for his high-school teacher, who was also his lover, in last year's fact-based drama *Murder in New Hampshire: The Pamela Smart Story*, starring Helen Hunt as femme fatale Pamela Smart. Incidentally, the telefilm was shot on location in Charlotte, S.C., hundreds of miles from Dover, N.H., where the events actually occurred.

Q: My wife and I are great fans of Barry Williams, who played Greg on The Brady Bunch. The Brady Bunch was always our favorite family show. Can you tell us where we can write to him?

—Esmeraldo Rivera, Astoria, N.Y.

A: Any big fan of Bradydom, especially a fan of Greg's, is sure to appreciate a book Williams released early this year titled *Growing Up Brady*. Inside, the eldest *Brady* boy offers some less-than-familial commentary about the cast's interactions during the taping of the popular show. To reach Williams, write in care of The Artists Group Ltd., 1939 Century Park West, Suite 403, Los Angeles, Calif., 90067.

Q: I would like to know who the leading man was opposite Katharine Hepburn in the wonderful TV movie Mrs. Delefield Wants to Marry. Is it available on video?

—Val Evensen, Durango, Colo.

A: Harold Gould played Hepburn's Jewish suitor in the 1986 effort. You could find no source that listed this telefilm as available on video.

Q: I saw Cab Calloway in person in Chicago in 1934. I would like a videotape of him. Where can I get one?

Jane Larson, Ironwood, Mich.

A: Calloway has appeared in both cameo appearances and performance clips in a number of movies. Try choosing from these titles: *Basin Street Revue*, *Big Bands at Disneyland*, *The Blues Brothers*, *Cab Calloway and His Orchestra*, *The Cincinnati Kid*, *Great Jazz Bands of the '30s*, *Harlem Har-*

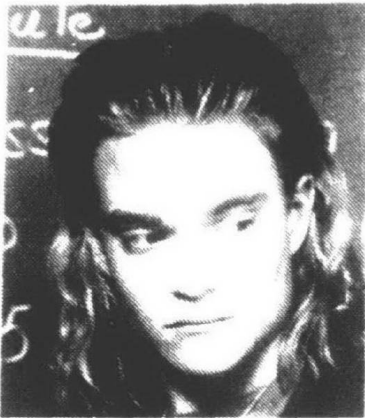

Chad Allen

monies Vol. 2, *Harlem Swings Vols. 1-3*, *Hi-De-Ho*, *International House Jazz Ball*, *The Littlest Angel*, *Manhattan Merry-Go-Round*, *Rhythm and Blues Review*, *Sensations*, *Sensations of 1948*, *Soundies Vol. I and II* and *Stormy Weather*.

Q: I was watching an old movie, The Drums, the other night and noticed it starred Sabu. Could you please give me some information on him? When and where was he born? What are some of his other movies, and were any made in his adulthood? Is he still alive?

—Don W. Schneider, Chillicothe, Mo.

A: The exotic-looking child actor was born Sabu Dastagir in Karapur, Mysore, India, on Jan. 27, 1924. He was working as a stable boy for a wealthy maharajah when American documentarian Robert Flaherty cast him in the title role in 1937's *Elephant Boy*. The mysterious and carefree persona of that and the following similar characters he played captivated both British and American audiences and led to a number of other films spotlighting the Indian boy in various adventures. His most notable role, of course, was as Mowgli in a 1942 screen adaptation of Rudyard Kipling's *The Jungle Book*, a precursor to the animated Disney film in 1967. His career waned when the mystique of jungle films did the same and after moving to Hollywood, he starred in a handful of other films before his sudden death as a result of heart failure in 1963.

Send questions to Let's Talk, Features Dept., P.O. Box 961009, Fort Worth, Texas, 76161-1009.

CABLE NEWS

Tough turkeys; day of the 'toons

By Dan Rice

It's Thanksgiving week and many Americans have their minds set on turkey dinner. The Discoveries Channel offers insight to the lot of the bird's free-ranging cousins with *The Wild Turkey* airing Sunday, Nov. 22 and *Emperor of the Eastern Woodlands* airing Monday, Nov. 23. Once championed by Ben Franklin as America's national animal, today the wild turkey is being hunted to near-extinction for sport as well as food.

One thing for sure about the day after Thanksgiving is there'll be cartoons to watch. Turner Broadcasting pulls out all the stops on Friday, Nov. 27, with a 14-hour tripartite celebration of animation. TBS Superstation has its "Bugs-a-ton," while TNT airs a "Looney Quest-Fest Marathon" and the Cartoon Network offers diversity with its "Cartoons A-Z," featuring the exploits of characters from *Atom Ant* to *Zoids*.

The 1991 death of actress Colleen Dewhurst left The Disney Channel's award-winning *As-Once* series without its marquee star. The series addresses the demise of Dewhurst's character, Marilla, without in the "Old Friends, Old Wives" episode, debuting Monday, Nov. 23. Dewhurst appears via flashbacks as the community mourns her passing and learns Marilla did not sign a will, leaving her home, Green Gables, subject to sale.



Al Pacino sits down to chat in Tuesday's *Barbara Walters Special* on ABC. Jerry Seinfeld also appears.

WEDNESDAY

AFTERNOON

NOVEMBER 25

	12 PM	12:30	1 PM	1:30	2 PM	2:30	3 PM	3:30	4 PM	4:30	5 PM	5:30
WFUM 28	M. Rogers	Lamb Chop	Frida: Gourmet	Joy of Painting	Nancy Sews	Shining Time	Mr. Rogers	Sesame Street	Reading Rainbow	Sandiego?	Square One TV	
WJBC 2	News	Young and the Restless	Beautiful	As the World Turns	Guiding Light	News	News	Donatue				
WDIV 4	News	Rocky Shaw	Days of Our Lives	Another World	Murder, Willams	Sally Jessy Raphael	News					
WXYZ 7	News	Drinks	All My Children	One Life to Live	General Hospital	Dorothy Whitely	News					
WBET 9	Mitzy	Emmental	High Road	Edgewater Street	Neigh	Bill	Babar	Video Hits	Fame			5:30 Live!
WKBD 50	That Amigo	Andy Griffith	Little House on the Prairie	Bewitched	Alvin	Merry Melody	Jerry Kids	Tiny Toons	Batman	Saved by the Bell	Growing Pains	
WTVS 56	Frida: Gourmet	Health Matters	Reading Road Quiz	Sandiego?	Sesame Street	Barney & Friends	Reading Rainbow	Square One TV	Club Connect	Sandiego?	Con-nections	
WGPR 62	Robert Tilton	Ben Casey		Doc Hunt	Santa Barbara	Movie: Scout's Honor	G. Coleman					
WXON 20	Designing Women	Hi Street Blues	Anwar	Camp Candy	Ship & Dale	Tale Spin	Darwin's Duck	Goof Troop	Different World	Different World		
MTV 3	Casini MTV	100% MTV Rocks			MTV Books	Pick a Fight With MTV	Totally Different Pauly					
CNN 3	CNN Headline News					CNN Headline News						
TWC 4	100% Bus	140% Wthr	120% Bus	140% Wthr	120% Bus	140% Wthr	120% Bus	140% Wthr	120% Bus	140% Wthr	120% Bus	40% Travel
VH 1 5	100% VH 1 Jam	100% VH 1 Jam										
ESPN 6	Boxing: Mober	Boxing: Snapping	Top Rank Boxing From Washington	Black Sports	Quadrant	Global Superstar Wrestling	Powder Time	Glory Days				
PASS 7	Off Air											
AMC 9	Movie: Mary	Movie: Primrose Path	G. Rogers	Movie: A Star Is Born	Movie: Easy Living	J. Arthur	This Gun for Hire					
FAM 10	Movie: Paul Hogan	Bonanza	Father Knows Best	My Three Sons	Incredible Atomic Hour	ProStars	Wishkid	Popeye	Inspector Gadget			
MAX 12	Movie: Kingdom of the Spiders	Movie: Fire, Ice and Dynamite	R. Moore	Movie: Cromwell	R. Harris	A. Guinness	G.I.					
TMC 16	Movie: Flatliners	Movie: Highlander 2: The Quickening	G. Lambert (R)	Movie: King of Marvin Gardens	J. Nicholson	Movie: Two of a Kind	J. Travolta	Spirit of 76				
HBO 21	Movie: Fanny Farm	Movie: Over the Top	R. Stallone	Movie: Don't Tell Her It's Me	S. Guttenberg	J. Gertz (PG13)	45: Movie: Collision Course	P. Monty	L. Leo (PG)			
WGN 30	News	News	News	News	News	News	News	News	News	News	News	News
TBS 31	Movie: Heaven With a Gun	G. Galt	Movie: Dr. Cook's Garden	B. Crosby	F. Converse	Movie: Eight Is Enough: A Family Reunion	A. Van Patten	W. Armes				
SCI 32	Movie: The Untouchables	Movie: The Untouchables	Movie: The Untouchables	Movie: The Untouchables	Movie: The Untouchables	Movie: The Untouchables	Movie: The Untouchables	Movie: The Untouchables	Movie: The Untouchables	Movie: The Untouchables	Movie: The Untouchables	Movie: The Untouchables
LEE 33	Movie: The Untouchables	Movie: The Untouchables	Movie: The Untouchables	Movie: The Untouchables	Movie: The Untouchables	Movie: The Untouchables	Movie: The Untouchables	Movie: The Untouchables	Movie: The Untouchables	Movie: The Untouchables	Movie: The Untouchables	Movie: The Untouchables
NICK 34	Movie: The Untouchables	Movie: The Untouchables	Movie: The Untouchables	Movie: The Untouchables	Movie: The Untouchables	Movie: The Untouchables	Movie: The Untouchables	Movie: The Untouchables	Movie: The Untouchables	Movie: The Untouchables	Movie: The Untouchables	Movie: The Untouchables
USA 35	Movie: The Untouchables	Movie: The Untouchables	Movie: The Untouchables	Movie: The Untouchables	Movie: The Untouchables	Movie: The Untouchables	Movie: The Untouchables	Movie: The Untouchables	Movie: The Untouchables	Movie: The Untouchables	Movie: The Untouchables	Movie: The Untouchables
CNN 36	Movie: The Untouchables	Movie: The Untouchables	Movie: The Untouchables	Movie: The Untouchables	Movie: The Untouchables	Movie: The Untouchables	Movie: The Untouchables	Movie: The Untouchables	Movie: The Untouchables	Movie: The Untouchables	Movie: The Untouchables	Movie: The Untouchables
AAE 37	Movie: The Untouchables	Movie: The Untouchables	Movie: The Untouchables	Movie: The Untouchables	Movie: The Untouchables	Movie: The Untouchables	Movie: The Untouchables	Movie: The Untouchables	Movie: The Untouchables	Movie: The Untouchables	Movie: The Untouchables	Movie: The Untouchables
CNBC 38	Movie: The Untouchables	Movie: The Untouchables	Movie: The Untouchables	Movie: The Untouchables	Movie: The Untouchables	Movie: The Untouchables	Movie: The Untouchables	Movie: The Untouchables	Movie: The Untouchables	Movie: The Untouchables	Movie: The Untouchables	Movie: The Untouchables
TNN 39	Movie: The Untouchables	Movie: The Untouchables	Movie: The Untouchables	Movie: The Untouchables	Movie: The Untouchables	Movie: The Untouchables	Movie: The Untouchables	Movie: The Untouchables	Movie: The Untouchables	Movie: The Untouchables	Movie: The Untouchables	Movie: The Untouchables
TNT 40	Movie: The Untouchables	Movie: The Untouchables	Movie: The Untouchables	Movie: The Untouchables	Movie: The Untouchables	Movie: The Untouchables	Movie: The Untouchables	Movie: The Untouchables	Movie: The Untouchables	Movie: The Untouchables	Movie: The Untouchables	Movie: The Untouchables
TLC 41	Movie: The Untouchables	Movie: The Untouchables	Movie: The Untouchables	Movie: The Untouchables	Movie: The Untouchables	Movie: The Untouchables	Movie: The Untouchables	Movie: The Untouchables	Movie: The Untouchables	Movie: The Untouchables	Movie: The Untouchables	Movie: The Untouchables
BET 42	Movie: The Untouchables	Movie: The Untouchables	Movie: The Untouchables	Movie: The Untouchables	Movie: The Untouchables	Movie: The Untouchables	Movie: The Untouchables	Movie: The Untouchables	Movie: The Untouchables	Movie: The Untouchables	Movie: The Untouchables	Movie: The Untouchables
CSPAN 43	Movie: The Untouchables	Movie: The Untouchables	Movie: The Untouchables	Movie: The Untouchables	Movie: The Untouchables	Movie: The Untouchables	Movie: The Untouchables	Movie: The Untouchables	Movie: The Untouchables	Movie: The Untouchables	Movie: The Untouchables	Movie: The Untouchables
DISC 44	Movie: The Untouchables	Movie: The Untouchables	Movie: The Untouchables	Movie: The Untouchables	Movie: The Untouchables	Movie: The Untouchables	Movie: The Untouchables	Movie: The Untouchables	Movie: The Untouchables	Movie: The Untouchables	Movie: The Untouchables	Movie: The Untouchables
SHOW 45	Movie: The Untouchables	Movie: The Untouchables	Movie: The Untouchables	Movie: The Untouchables	Movie: The Untouchables	Movie: The Untouchables	Movie: The Untouchables	Movie: The Untouchables	Movie: The Untouchables	Movie: The Untouchables	Movie: The Untouchables	Movie: The Untouchables
DISN 46	Movie: The Untouchables	Movie: The Untouchables	Movie: The Untouchables	Movie: The Untouchables	Movie: The Untouchables	Movie: The Untouchables	Movie: The Untouchables	Movie: The Untouchables	Movie: The Untouchables	Movie: The Untouchables	Movie: The Untouchables	Movie: The Untouchables

LOCAL PROGRAMMING - Wednesday Afternoon

- 3:00 8 Marching Band Competition
- 15 Plym. Twp. Trustees Meeting
- 4:00 6 Omnicon Sports
- 5:00 15 M.F.S.C. Job Show
- 5:30 8 Plym. Canton Chieftees
- 15 Wednesday Report

WEDNESDAY PRIME TIME NOVEMBER 25

Table listing TV programs for Wednesday, November 25, from 6 PM to 10:30 PM. Includes channels like MTV, CNN, ESPN, and various show titles such as 'Classic MTV', 'CNN Headline News', and 'College Basketball'.

WEDNESDAY PRIME TIME NOVEMBER 25

Table listing TV programs for Wednesday, November 25, from 6 PM to 10:30 PM. Includes channels like WFUM, WJBK, WDIV, and various show titles such as 'City for Youth', 'Nightly Business Report', and 'Dinosaurs!'.

LOCAL PROGRAMMING - Wednesday Evening

Table listing local programming for Wednesday evening, including 'It's Your Money', 'Gospel Hits', 'Polka International', and 'Mehfil'.

Table listing TV programs for Wednesday, November 25, from 11 PM to 2:30 AM. Includes channels like MTV, CNN, TWC, and various show titles such as 'To Be Announced', 'CNN Headline News', and 'Good Evening Forecast'.

CROSSWORD QUIZ

SOAP TALK

What are twin brothers for?

By Candace Havens

Dear Candace I have to say that I am so upset with NBC for taking *Santa Barbara* off the air. It is the best show on television.

My question is about the show's district attorney, Ben Arnold. I want to know if there is a different actor in the role now than in the beginning? It looks like the same man, but he really sounds different.

Also, on *As the World Turns*, is the woman who plays Neal Alcott the same person who was India Spaulding on *Guiding Light*? -I. W. in North Carolina

Dear Reader Your suspicions about Ben Arnold are right on the money. The character was originally played by Mitchell Laurence, who left the soap to return to his recurring role on *Reasonable Doubts*. SB was able to recast the role with Matthew Laurence, Mitchell's twin brother.

Mary Kay Adams did portray India on *GL* from 1984-87.

Dear Candace I read in your column about Lynn Herring leaving *Days of Our Lives*. I thought you said that Lynn Herring had a two-year contract with *Days*. Now all of the sudden she is off the show. I thought for sure they were going to have her romantically linked with her husband, Wayne Northrop, who plays Roman Brady.

Dear Reader Lynn Herring is now back on *General Hospital* as Lucy Cole. Herring left *GH* to take on the role of Lisanne Gardner on *Days of Our Lives*. Things didn't work out the way she had hoped with the character, and it was a mutual agreement that she should leave. Besides, there are always outs for contracts. There was never any indication she would be paired with her husband on the show.

Dear Candace What happened to Joan Van Ark on *Knots Landing*? I can't believe she is off the show. Valerie is one of my favorite characters, and I love to see her and Gary together.

Dear Reader There were several rumors going around, but the facts CBS brass were peeved when Van Ark did a pilot for another network and didn't bother telling anyone at CBS.

Send your comments to Candace Havens, Soap Talk, P.O. Box 961009, Fort Worth, Texas, 76161-1009.

	1	2	3	4		5	6	7	8	
9			*			10			*	11
12	*				13	14	15			16
17			18	*				19	*	20
21		22						23	24	
	25		*					26	*	
	27							28		*
29								30		31
32			33	34	35	36	37			38
39	40		41	*				42		
43	*		44	*				45	46	*
	47							48		

Leader of the Rat Pack

The answer to the Crossword Quiz is found within the answers in the puzzle. To find the answer, unscramble the letters noted with asterisks within the puzzle.

ACROSS

- 1. Main character in *Evening Shade*
- 2. Betty of the cartoons
- 3. Flashy star from Spain
- 10. Jane Curtin role
- 12. The _____ Squad
- 13. A lot of _____ words to one who says something ridiculous
- 16. (XXX) Times V
- 17. Misnomer
- 18. Series about a hip radio talk show host
- 20. Kurt's monogram
- 21. Actress Padman
- 23. Takes advantage of
- 25. Animal refuge
- 26. Too bad
- 27. Greek letter
- 28. Opposite of a prof
- 29. Unchecked
- 30. Power source - abbr.
- 32. Common verb
- 33. Angel Street star
- 34. Unit of time - abbr.
- 35. Funding for Max or Paul
- 41. Ham-tripper
- 42. A lot of them
- 43. Take with
- 45. Actress from Italy
- 47. Patterns
- 48. Gambler's win

- 11. Labor and others
- 14. Next later's syllable
- 15. _____ a loss - confused
- 18. Creating
- 19. Show set in a hospital
- 22. Gaelic language
- 24. Music style
- 29. Sad notice, for short
- 31. Famous murderer
- 34. Singer But
- 35. Wayne Newton's state of birth - abbr.
- 36. Suffix for hard or dark
- 37. Actress-singer Carter
- 40. Oh's homonym
- 42. Women in religious orders - abbr.
- 44. "Coyote State" - abbr.
- 46. Initials of Popeye's love

Solution

	S	O	L	S		D	E	S		
N	E	S	E		T	E	A	S	E	
I	N	E		V	A	N	E			
N	A	G	I	V	E	N	S			
C	E	L	E			N	E			
R	O	T				A	R	K		
S						U	S	E	S	
K	A					R	A	R	T	I
H	A	T	R	E	A	T	D	C	V	
C	H	A	R	O						
B	O	D								

DOWN

- 1. Covered M. Adams - abbr.
- 2. Carpal pain
- 3. African wind
- 4. Girl's name
- 5. Island east of Asia
- 6. Devant's insight
- 7. Over the hill
- 9. Series set in Rome - Wisconsin - 27
- 11. Mother of Flashy

THURSDAY

AFTERNOON

NOVEMBER 26

	12 PM	12:30	1 PM	1:30	2 PM	2:30	3 PM	3:30	4 PM	4:30	5 PM	5:30
WFUM 13 28	M. Rogers	Santa Clara	Gourmet	R. Warren	Embrak	Shining Time	Mr. Rogers	Sesame Street	Reading Rainbow	Sandiego	Square One TV	
WJBC 23 2	Moose on the Mayflower	Teen Turtles	Movie: <i>Teenage Mutant Ninja Turtles</i> J. Hoag					NFL Today	NFL Football: Giants at Cowboys (L)			
WDIV 23 4	NFL Live	NFL Football: Oilers at Lions (L)						Postgame	Sally Jessy Raphael	Maury Povich		
WXYZ 20 7	Oran's Witney	College Football: Auburn vs. Alabama (L)							Movie: <i>Thanksgiving Promise</i> B. Bridges			
CBET 25 9	Middav	Emmerdal	High Road	Coronation Street	Neigh	Bill	Babar	Video Hits	Fame		5:30 Live	
WKBD 20 50	That's Amore	Andy Griffith	Little House on the Prairie	Bewitched	Avon	Merry Melody	Jerry Kids	Tiny Toons	Batman	Saved by the Bell	Growing Pains	
WTVS 27 56	Wonderworks Family Movie	Long Ago & Far Away	Wonderworks Family Movie	J. Rushton N. Beatty				Wonderworks Family Movie	R. Guillaume T. Reid			
WGPR 20 62	Robert Taylor	Ben Casey	Lou Grant				Santa Barbara	Movie: <i>Shame, Shame on the Bizzy Boys</i> M. Markham, D. Barry (PG)				
WXON 20 20	Designing Women	Hit Street Blues	Airwolf		Camp Candy	Chip & Dale	Tale Spin	Darkwing Duck	Goof Troop	Different World	Different World	
MTV 2	11th Annual MTV Video Music Awards				Video Music Awards	Winners Spotlight	Special Xmas	Paul's Totally Stuffed Thanksgiving				
CNN 3	CNN Headline News							CNN Headline News				
TWC 4	20 Bus	4 Wthr	20 Bus	40 Wthr	20 Bus	40 Wthr	20 Bus	40 Wthr	20 Bus	40 Wthr	20 Bus	40 Wthr
VH1 5	1992 VH1 Jam	VH1 Jam						This is VH1 Country	VH1 Block Party			
ESPN 6	College Cheerleading Championships	America's Wilderness: The Stuntmen			Knockout		Amazing Games	Sport Day	Ski World	Expedition Earth		
PASS 7	Dr. Air											
AMC 9	11:30 Movie: <i>Blood on the Moon</i>	Movie: <i>Whispering Smith</i> A. Ladd	Movie: <i>Gunfighter</i> G. Peck		Movie: <i>Annie Oakley</i> B. Stanwyck						Wagon	
FAM 10	Augie Doggie	Popeye	Waltons: The Thanksgiving Story	R. Thomas	Incredible Animal Hour	ProStars	Wishkic	Popeye	Inspector Gadget			
MAX 17	11:30 Movie: <i>Never-Ending Story II</i> (PG)	Movie: <i>Stars and Stripes Forever</i> G. Webb, D. Paget	Movie: <i>Romancing the Stone</i> M. Douglas, K. Turner (PG)		(15) Movie: <i>Adventures of Buckaroo Banzai Across 8th Dimension</i> P. Weiler, J. Limgow							
TMC 19	Movie: <i>Magnificent Seven</i> Y. Brynner, S. McQueen	Movie: <i>Deceived</i> G. Hawn, J. Heard (PG13)			Movie: <i>Long Walk Home</i> S. Spacek, W. Goldberg (PG)							
HBO 21	11:30 Movie: <i>Seems Like Old Times</i> G. Hawn	Movie: <i>Airplane II: The Sequel</i> R. Hays, J. Hageny (PG)	Movie: <i>American Hot Wax</i> T. McIntire, F. Drescher (PG)		Movie: <i>Curly Sue</i> J. Belushi, K. Lynch							
WRN 30	Geraldo	News	Andy Griffith	Honey-mooners	Designing Women	Saved by the Bell	Three Stooges	Hulk Hogan	Funt Stones	Captain N		
TBS 31	10:30 Movie: <i>Joe Kidd</i> G. Eastwood, J. Saxon	10:55 Movie: <i>High Plains Drifter</i> G. Eastwood	10:55 Movie: <i>A Fistful of Dollars</i> G. Eastwood									
SCI 32	Dr. Who	Lost in Space	Voyage to the Bottom of the Sea		Movie: <i>Attack of the Killer Tomatoes</i> D. Miller, G. Wilson (PG)		One Step Beyond	Incredible Hulk				
LIFE 33	Fruga	Ship To You Drop	Supermarket	Born Lucky	Movie: <i>Murder in Black and White</i> R. Crenna	Movie: <i>A Case of Deadly Force</i> R. Crenna, J. Shea						
NICK 34	Elephant	Thanks, Fest	Noozies	Elf Bits	Muppet Babies	Dennis the Menace	Flipper	Looney Tunes	Underdog	Yogi	Nick Arcade	Hey Dude
USA 35	11:30 Movie: <i>Uncle Buck</i> J. Grady (PG)	Movie: <i>Fletch Lives</i> G. Chase, G. Little (PG)	Movie: <i>Renegades</i> K. Sutherland, L. Diamond		Phillips (R)						Cartoon Express	
CNN 36	NewsHour	Sonya Live	NewsDay		International Hour	EarlyPrime	Politics 92	EarlyPrime	ShowBiz Today			
AAE 37	Divided Union	Divided Union	Divided Union		Divided Union	Divided Union	Divided Union	Divided Union	Divided Union			
CNBC 38	CNBC Thanksgiving Day Talkfest: Cont.											
TNN 39	Cookin' USA	Bring Our Way	Emek and Chase	Be a Star	Top Card	Cookin' USA	On Stage	Club Dance	Be a Star	VideoPM		
TNT 41	Movie: <i>Wonders of Aladdin</i> D. G. Connor	Movie: <i>Captain Sinbad</i> G. Williams, H. Bohn	Movie: <i>Thief of Baghdad</i> S. Reeves, G. Moll									
TLC 42	Cheerleaders	Mexican Cook	HomeTime	Antiques	Yan Can Cook	So Cooking	Madeleine Cooks	Cooking Zone	Renovation	Do It Yourself	Yan Can Cook	So Cooking
BET 43	11:30 Heart & Soul: B. & B.	Video: Soul					Video Vibrations		Rap City			
CSPAN 44	11:30 U.S. House of Representatives	U.S. House of Representatives										
DISC 45	Easy Does It	Home Works	Pasquale	Great Chefs	Gourmet	Graham Kerr	Easy Does It	Home Works	World Away	Beyond 2000		
SHOW 46	11:35 NAKIA	Movie: <i>Fast Getaway</i> G. Hamm, L. Riss (PG13)	Gombat Karate: The World Championships		Movie: <i>Romancing the Stone</i> M. Douglas, K. Turner (PG)						Case blanca	
DISN 48	Walt Disney Presents	Movie: <i>Rescuers Down Under</i> (G)	Making of Aladdin		Movie: <i>Swiss Family Robinson</i> J. Mills, D. McGuire (G)						Mickey Mouse	

LOCAL PROGRAMMING - Thursday Afternoon

Closed for the Holiday
Happy Thanksgiving!

THURSDAY PRIME TIME NOVEMBER 26

Table of TV programming for Thursday, November 26, 1992, from 6 PM to 10:30 PM. Channels include MTV, CNN, VH1, ESPN, PASS, AMC, FAM, MAX, TMC, HBO, WGN, TBS, SCI, LIFE, NICK, USA, CNN, A&E, CNBC, TNN, TNT, TLC, BET, CSPAN, DISC, SHOW, and DISN. Programs include 'Classic MTV', 'CNN Headline News', 'Stand Up Spotlight', 'Thoroughbred', '101 Jackson Action at Northville Downs', 'Madeline's Christmas', 'MOVIE Casablanca', 'MOVIE Rhinestone', 'MOVIE Curly Sue', 'Saved by the Bell', 'MOVIE Two Mules for Sister Sara', 'Incredible Hulk', 'Doubletake', 'What Would You Do?', 'MacGyver', 'World Today', 'Divided Union', 'CNBC Thanksgiving Day Talkfest', 'TNN VideoPM', 'Bugs Bunny & Pals', 'Cuisine Rapide', 'Video LP', 'News 1', 'Last Chance', 'SHOW MOVIE Casablanca', and 'This Island Earth'.

THURSDAY PRIME TIME NOVEMBER 26

Table of TV programming for Thursday, November 26, 1992, from 6 PM to 10:30 PM. Channels include WFUM, WJBK, WDIV, WXYZ, CBET, WKBD, WTUV, WGPR, and WXON. Programs include 'You for Youth', 'Nightly Business Report', 'MacNeil/Lehrer NewsHour', 'Practical Sportsman', 'Great Lakes Outdoors', 'Mystery! A murderer is on the loose (Pt. 2)', 'Passing Through', 'This Old House', '(4:00) NFL Football New York Giants at Dallas Cowboys (L)', 'Hard Copy', 'Current Affairs', 'MOVIE E.T. The Extra-Terrestrial', 'Evening Shade', 'News', 'NBC News', 'Wheel of Fortune', 'Jeopardy!', 'Out All Night On My Own', 'Different World', 'Cheers', 'Wings The Late Miss Biggins', 'L.A. Law', 'ABC News', 'Entertainment Tonight', 'Delta Climb That Mountain', 'Room for Two', 'Homefront A dance contest sparks rivalry (R)', 'PrimeTime Live', 'CBC News', 'Material World', 'Jubilee Years', 'CFL Awards From Toronto coverage of the CFL Awards', 'CBC Prime Time News', 'MOVIE Night Zoo (Drama Subtitled) (1987) G. Maheu, R. Le Bel (R)', 'Roseanne', 'Golden Girls', 'Married With Children', 'You Bet Your Life', 'Simpsons Radio Bart', 'Martin Forever Sheneneh', 'Heights A woman puts a curse on J.T. Dizzy drives Jody crazy', 'News', 'MacNeil/Lehrer NewsHour', 'Nightly Business Report', 'Fred Trost's Practical Sportsman', 'Wild America', 'This Old House', 'Barn Again! Barns are symbols of sentiment, heritage and progress', 'Mystery! A murderer is on the loose (Pt. 2)', 'New Dance', 'Streets of San Francisco A Teenage Prostitution Ring', 'Straight Gate Church', 'Robert Tilton', 'Hour of Deiverance', 'Full House', 'Perfect Strangers', '227 Lester's former boss visits', 'Designing Women', 'MOVIE Murphy's Romance (Comedy) (1985) A divorcee finds her life complicated by her ex-husband and a widower. S. Field, J. Garner (PG13)', 'In the Heat of the Night An old friend visits. Althea'.

LOCAL PROGRAMMING - Thursday Evening

Closed for the Holiday Happy Thanksgiving!

Table of local TV programming for Thursday, November 26, 1992, from 11 PM to 2:30 AM. Channels include MTV, CNN, TWC, VH1, ESPN, PASS, AMC, WFUM, FAM, MAX, TMC, HBO, WJBK, WDIV, WXYZ, CBET, WKBD, WTUV, WGPR, WXON, WGN, TBS, SCI, LIFE, NICK, USA, CNN, A&E, CNBC, TNN, TNT, TLC, BET, CSPAN, DISC, SHOW, and DISN. Programs include 'Pauly's Totally Stuffed Thanksgiving', 'Alternative Nation', 'MTV Dreamtime', '(9:05) CNN Headline News', 'CNN Headline News', '(12:00) Bus', '(1:40) Travel', 'Good Evening Forecast', 'Good Evening Forecast', 'Sex Symbols', 'Rock After Hours', 'Allnighter', '(11:30) Sports', 'NFL Moments', 'Tunnel Boat', 'Powder Mag', 'Ski Magic', 'Thoroughbred', 'SportsCenter', 'Eight Night at the Forum: From Ingewood, Calif. [L]', 'Off Air', 'Movie Winchester '73 J. Stewart, S. Winters', 'Movie Big Sky K. Douglas, D. Martin', 'Streamside', 'Mich. Mag', 'Nova', 'Off Air', 'Scarecrow and Mrs. King', 'Bonanza: The Lost Episodes', 'Bordertown', 'Paid Program', '700 Club With Pat Robertson', 'Movie Two Evil Eyes H. Keizer, A. Barbau', 'Movie Purgatory T. Roberts, J. Pop', '(1:40) Desire', 'Movie Deceived G. Hawn, J. Heard', 'Movie Heat B. Reynolds, K. Young', 'Inside the NFL', 'Movie Last Boy Scout B. Willis, D. Wayans', '(1:50) Dream On', '(1:20) Godfather, Part III', 'News', '(1:35) N. Ct.', '(1:05) Cheers', '(1:35) Arsenal Hall', '(1:35) Amen', '(1:05) Up to the Minute', 'News', '(1:35) Tonight Show', '(1:35) Late Night', '(1:35) In Edition', '(1:05) Costas', '(1:35) N. Side', 'News', 'Nightline', 'Matlock', 'NightTalk With Jane Whitney', 'Whoopi', 'World News', '(10:00) Night Zoo G. Maheu', 'Walter and June I. McKellen', 'Off Air', 'Murphy Brown', 'Star Trek: The Next Generation', 'Star Strch', 'That's Amore', 'Hunter', 'Idolmaker', 'Being Served', 'Rumpole of the Bailey', 'F. Trust', 'This Old House', 'Outdoorsman', 'Barn Again!', 'Family Feud', 'Step Beyond', 'Streets of San Francisco', 'Combat', 'New Dance', 'Love Connect', 'Love Connect', 'Studs', 'People's Court', 'All Family', 'Movie Lucas C. Ham, K. Green', 'Night Court', 'Kojak', 'Movie Help Wanted: Male S. Pleshette, G. Gerard', 'Bob Newhart', '(11:00) Where Eagles Dare R. Burton, C. Eastwood', '(1:05) Movie Kelly's Heroes C. Eastwood, T. Savalas', 'Darkside', 'Night Gallery', 'Buck Rogers', 'War of the Worlds', 'Planet of the Apes', 'thirtysomething', 'China Beach', 'Mysteries', 'Self Improvement Guide', 'Lucy Show', 'F. Troop', 'Mr. Ed', 'Dobie Gillis', 'Patty Duke', 'Donna Reed', 'America 2Night', 'Mary T. Moore', 'Lucy, Butch', 'MacGyver', 'Hitchhiker', 'Ray Bradbury', 'Movie 9 to 5 J. Fonda, L. Tomlin', 'Sports Tonight', 'Moneyline', 'NewsNight', 'Crossfire', 'Larry King Live!', 'World Update', 'Sports Nite', 'Evening at the Improv', 'Real West', 'Earnore!', 'Brute Force', 'Steal & Deal', 'Real Story', 'Dick Cavett', 'Poz, Donahue', 'Real Personal', 'Smart Money', 'Your Parting', 'Paid Program', 'Club Dance', 'Miller & Company', 'Dinan Shore: A Conversation With Burt Reynolds', 'On Stage', '(11:05) First Men in the Moon E. Judd', 'Movie Prehistoric Women M. Beswick, E. Ronay', 'Vengeance She', 'Science Frontiers', 'Cells', 'Revelations', 'Antiques', 'Floyd of Oz', 'Comicview', 'Between Sexes', 'St. Lucia Jazz Festival', 'Comicview', 'Screen Scene', 'Video Soul', 'Event of the Day', 'World of Valor', 'Safar', 'America', 'Nature of Things', 'World of Valor', 'Safar', 'America', 'Nature of Things', 'Movie Run P. Dempsey, K. Preston', '(10:00) Comedy', '(1:40) Movie American Ninja 4: The Annihilation', '(11:00) Movie Guys and Dolls F. Sinatra, M. Brando', 'Swiss Family Robinson J. Mills'.

drapery boutique

Since 1969 INC.

Custom Draperies

Design With Imagination!

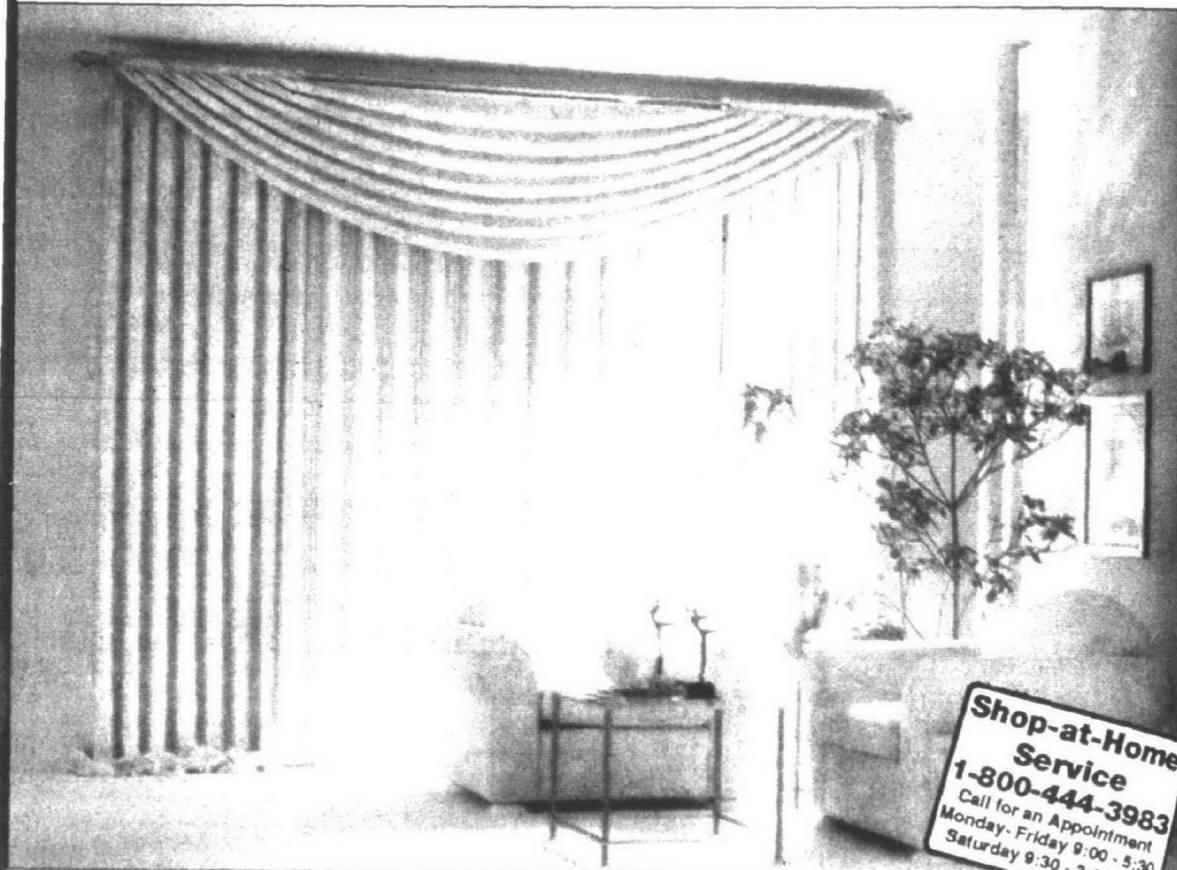

Shop-at-Home Service
 1-800-444-3983
 Call for an Appointment
 Monday-Friday 9:00 - 5:30
 Saturday 9:30 - 3:00 pm.

50% OFF • Designer Fabrics
 • Deluxe Lining
 • Labor For Draperies

•Select from over 1200 designer fabrics : Prints, satins, boucles, sheers & casements to complement practically every decor. Let our professional design staff help you with creations like fancy swags or cornice boards that give your windows that "finishing touch" Professional installation, by our own expert staff, completes your own "original" look.

Free Installation* Custom Vertical Blinds

- Free Freight
- Free Installation*
- No Handling Charges

63% TO **80%** OFF RETAIL PRICES ON ALL SIZES

Select from 120 first quality styles of P.V.C.'s, stich bond fabrics & innovative macrame knit vertical blinds.

P.V.C. STYLES

Pattern Size SAMPLE SIZES AND PRICES	C-Curve "Matte" P.V.C.	C-Curve Line II & Ridge P.V.C.	NEW PRISM P.V.C.	NEW VIEW P.V.C.	C-Curve Ice, Lustrous Decors	C-Curve Accent, Marble, Ombre.
Discount	73%	73%	70%	65%	63%	63%
50" x 36"	41.58	45.36	50.40	58.80	64.38	65.12
74" x 60"	64.80	69.66	77.40	90.30	101.01	109.89
85" x 84"	79.38	85.05	94.50	110.25	126.54	147.63
108" x 84"	101.25	107.46	119.40	139.30	158.73	177.60

FABRIC STYLES

Pattern Size SAMPLE SIZES AND PRICES	NEW Gale Fabric	Regal Fabric	Regis, Tuff Fabric	Bark & Lattice Fabric	Stone Fabric	Polo I & Polo II Mirage Fabric	Cobbles Dual-tone Fabric
Discount	80%	75%	75%	78%	75%	70%	75%
50" x 36"	45.00	47.50	61.25	64.24	73.00	73.20	71.25
74" x 60"	80.80	83.00	94.00	122.76	139.50	135.30	124.25
85" x 84"	106.20	104.50	120.75	148.50	168.75	179.10	162.25
108" x 84"	137.00	127.00	158.25	190.52	216.50	233.10	210.25

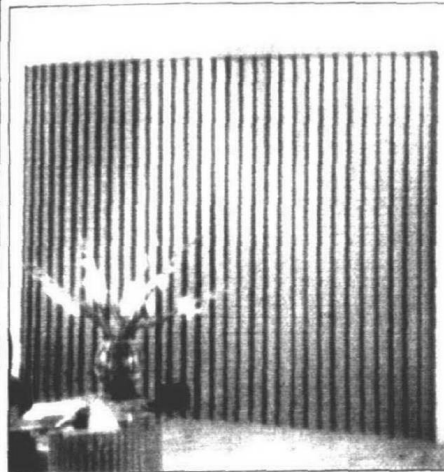

UP TO **76%** OFF RETAIL PRICE

Graber Elite 1" Mini Blinds
 •40 Designer Colors
 •Sleek New 1"x1" Headrail

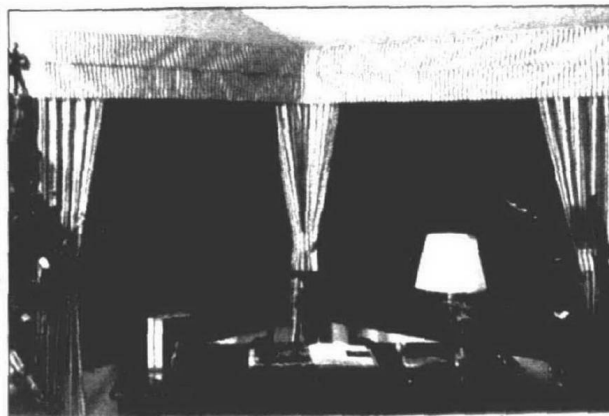

•Free Installation*

*Free installation: Minimum combined order of \$375 after discount and before sales tax and reside within a 10 mile radius of any of our stores. Receive an extra 5% savings if you do your own installation. Previous orders excluded. All vertical blind fabrics subject to availability. Limited to selected blinds.

SAMPLE SIZES & PRICES	FREE FREIGHT! NO HANDLING				
	UP TO 23"	UP TO 29"	UP TO 36"	UP TO 40"	UP TO 48"
Lengths up to 108"					
UP TO 42"	21.60	25.20	30.00	32.64	36.96
UP TO 48"	23.28	27.60	33.12	36.00	40.80
UP TO 54"	25.20	29.76	36.00	38.40	44.16
UP TO 60"	27.36	31.44	38.16	41.75	48.00

Drapery boutique coupon
 Free Freight &... **45% OFF**
 Special Order WALLPAPER

ALL 1300 SPECIAL ORDER BOOKS in our Library are 45% off. Present coupon at time of order only. Minimum order at sale price, \$50. Otherwise discount is only 40% off. Borders with coupon 35% off. FREE FREIGHT. Handling added. Sorry, charges not accepted for this special. Coupon Expires Jan. 3, 1993 CG-1

NOVI NORTHVILLE FARMINGTON Pepper Square 30253 Gd. River At Haggerty Rd. 478-3133	FARMINGTON HILLS WEST BLOOMFIELD BIRMINGHAM Orchard Lk. -14 ML Ctr. 30854 Orchard Lk. Rd. S. of 14 Mile Rd. 626-4313	TROY BLOOMFIELD ROCHESTER Venus Plaza 6046 Rochester Rd. At Sq. Lake Rd. 879-1010	CANTON PLYMOUTH LIVONIA Canton Corners 42775 Ford Rd. At Lilley 881-7400	STERLING HTS. WARREN UTICA CrossRoads Ctr. 37130 Van Dyke At 16 Mile Rd. 795-1500	Fashion With Value Always! db
--	---	--	---	--	---

FRIDAY AFTERNOON NOVEMBER 27

Grid of TV programming for Friday Afternoon, November 27, 1992. Columns represent time slots from 12 PM to 5:30 PM. Rows list various channels and their respective programs.

LOCAL PROGRAMMING - Friday Afternoon

Closed for the Holiday Happy Thanksgiving!

FRIDAY PRIME TIME NOVEMBER 27

Grid of TV programming for Friday Prime Time, November 27, 1992. Columns represent time slots from 6 PM to 10:30 PM. Rows list various channels and their respective programs.

FRIDAY

PRIME TIME

NOVEMBER 27

Table with 11 columns (6 PM to 10:30) and 11 rows of programming for Friday, Nov 27. Includes shows like City for Youth, Nightly Business Report, MacNeil/Lehrer NewsHour, Washington Week in Review, Wall Street Week, Talking With David Frost, Garrison Keillor's Home, News, CBS News, Hard Copy, Current Affairs, Golden Palace, Major Dad, All New Circus of the Stars & Side Show XVII, and more.

LOCAL PROGRAMMING - Friday Evening

Closed for the Holiday
Happy Thanksgiving!

Table with 8 columns (11 PM to 2:30) and 40 rows of programming for Friday, Nov 27. Includes shows like MTV Weekend Blastoff, CNN Headline News, TWC Good Evening Forecast, VH-1 Weekend Jam, ESPN Auto Racing, PASS NHL Hockey, AMC Movie: Crack in the World, WFUM Off Air, FAM Pad Program, MAX Lady Chatterley's Passions, TMC Movie: Once Around, HBO Movie: Bloodlist III, WJBK News, WDIV News, WXYZ News, CBET News, WKBD News, WTVS News, WGPR News, WXON News, TBS News, SCI News, LIFE News, NICK News, USA News, CNN News, A&E News, CNBC News, TNN News, TNT News, TLC News, BET News, CSPAN News, DISC News, SHOW News, DISN News.

Note: Owl listings: 2:30 am to 6 am start on page 33

SATURDAY

MORNING

NOVEMBER 28

Table with 12 columns (6 AM to 11:30) and 28 rows of programming for Saturday, Nov 28. Includes shows like WFUM Off Air, WJBK News, WDIV News, WXYZ News, CBET News, WKBD News, WTVS News, WGPR News, WXON News, MTV News, CNNII News, TWC News, VH-1 News, ESPN News, PASS News, AMC News, FAM News, MAX News, TMC News, HBO News, WJBK News, WDIV News, WXYZ News, CBET News, WKBD News, WTVS News, WGPR News, WXON News, TBS News, SCI News, LIFE News, NICK News, USA News, CNN News, A&E News, CNBC News, TNN News, TNT News, TLC News, BET News, CSPAN News, DISC News, SHOW News, DISN News.

Cable/TV Weekly
Your Family's Source
For Home Entertainment
Includes two cartoon faces and the company name.

SATURDAY

AFTERNOON

NOVEMBER 28

Grid of TV channels and programs for Saturday Afternoon, including channels like WFUM, WJBL, WDIV, WXYZ, CBET, WKBD, WTYS, WGPB, WXON, MTV, CNN, TWC, VH1, ESPN, PASS, AMC, FAM, MAX, TMC, HBO, WGN, TBS, SCI, LIFE, NICK, USA, CNN, A&E, CNBC, TNN, TNT, TLC, GSPAN, DISC, SHOW, DISN.

LOCAL PROGRAMMING - Saturday Afternoon

Closed for the Holiday
Happy Thanksgiving!

SATURDAY

PRIME TIME

NOVEMBER 28

Grid of TV channels and programs for Saturday Prime Time, including channels like MTV, CNN, VH1, ESPN, PASS, AMC, FAM, MAX, TMC, HBO, WGN, TBS, SCI, LIFE, NICK, USA, CNN, A&E, CNBC, TNN, TNT, TNT, TLC, GSPAN, DISC, SHOW, DISN.

SATURDAY PRIME TIME NOVEMBER 28

Table with columns for time slots (6 PM to 10:30) and rows for various TV channels (WFUM, WJBK, WDIV, WXYZ, CBET, WKBD, WTVS, WGPR, WXON) listing their respective programs.

LOCAL PROGRAMMING - Saturday Evening

Closed for the Holiday Happy Thanksgiving!

Large table listing TV programming from 11 PM to 2:30 AM, including channels like MTV, CNN, TWC, VH-1, ESPN, PASS, AMC, EAM, MAX, TMC, HBO, WJBK, WDIV, WXYZ, CBET, WKBD, WTVS, WGPR, WXON, WGN, TBS, SCI, LIFE, NICK, USA, CNN, A&E, CNBC, TNN, TNT, TLC, BET, CSPAN, DISC, SHOW, and DISN.

SUNDAY MORNING NOVEMBER 29

Table with columns for time slots (6 AM to 11:30) and rows for various TV channels (WFUM, WJBK, WDIV, WXYZ, CBET, WKBD, WTVS, WGPR, WXON, MTV, CNN, TWC, VH-1, ESPN, PASS, AMC, EAM, MAX, TMC, HBO, WGN, TBS, SCI, LIFE, NICK, USA, CNN, A&E, CNBC, TNN, TNT, TLC, BET, CSPAN, DISC, SHOW, DISN) listing their respective programs.

YOU COULD LEARN A LOT FROM A DUMMY. BUCKLE YOUR SAFETY BELT.



SUNDAY PRIME TIME NOVEMBER 29

Table with columns for time slots (6 PM to 10:30) and rows for various TV channels (WFUM, WJBK, WDIV, WXYZ, CBET, WKBD, WTVS, WGPR, WXON) listing their respective programs.

SUNDAY LATE NIGHT NOVEMBER 29

Table with columns for time slots (11 PM to 2:30) and rows for various TV channels (MTV, CNN, TWC, VH1, ESPN, PASS, AMC, WFUM, FAM, MAX, TMC, HBO, WJBK, WDIV, WXYZ, CBET, WKBD, WTVS, WGPR, WXON, WGN, TBS, SCI, LIFE, NICK, USA, CNN, A&E, CNBC, TNN, TNT, TLC, BET, CSPAN, DISC, SHOW, DISN) listing their respective programs.

Nite Owl listings, 2:30 am to 8 am start on page 33

NIGHT OWL LISTINGS FROM 2:30 am to 6:00 am

MONDAY November 23

- 2:30 SportsCenter
2:50 MOVIE: At Close Range (Drama) 1986: Two teenage boys join their father in thievery. Sean Penn, Christopher Walken. R
3:00 Sports LateNight
2:45 MOVIE: Hardcore (Drama) 1979: A man searches for his daughter in the world of pornography. George C. Scott, Season Hubley. R
4:00 MOVIE: Desire (Romantic Comedy) 1990: A music student finds love and passion in Italy at carnival time. Rose, Marc Gaby Ford. R
3:00 Up Close
1: MOVIE: House Party 2 (Comedy) 1991: Two friends adjust to college life and throw a massive house party. Christopher Martin, Christopher Reid. R
2: MOVIE: The Far Frontier (Western) 1948: Roy breaks up a gang that is smuggling criminals into the U.S. Roy Rogers, Andy Devine.
3:05 MOVIE: Hail the Conquering Hero (Comedy) 1944: An Army reject is mistakenly thought to be a war hero. Eddie Bracken, Ella Raines.
3:30 Off Road Racing Ford Gold Coast 300 from Las Vegas (PT 1) (R)
2:58 Ten Thousand Eyes A look at the work of professional photographers around the world.
4:1 MOVIE: The Outlaw (Western) 1943: Billy the Kid meets his match in a strong beautiful woman. Jane Bryan, Jack Butler.
4:3 MOVIE: Guys and Dolls (Musical Comedy) 1955: A gangster falls for the woman in charge of the local mission. Frank Sinatra, Marlon Brando.
3:50 MOVIE: The Golden Child (Fantasy Comedy) 1986: A man tries to rescue a magical child from the forces of evil. Eddie Murphy, Charlotte Lewis. R
4:00 Off Road Racing Ford Gold Coast 300 from Las Vegas (PT 2) (R)
2:58 MOVIE: Lights, Camera, Action, Love (Romance) 1982: An actress, a director and a cameraman create a romantic triangle. Laura Annunzi, Jay Hudson.
3:1 MOVIE: Chamber of Horrors (Horror) 1940: The victims of brutal killings are taken to the Chamber of Horrors. L. L. Ranks, Edith Piaf.
3:7 MOVIE: When Michael Calls (Suspense) 1971: A woman is terrorized by phone calls from a child believed to be dead. Michael Douglas, Barbra Streisand.
4:20 MOVIE: The Rapture (Fantasy Drama) 1991: A woman becomes involved at the end of the world is approaching. M. Rogers, David Duchovny. R
4:30 NHRA Racing Sears Roebuck and Montgomery Ward National Finals from Topeka, Kan. (R)
4:35 MOVIE: Novel Desires (Romantic Drama) 1991: A writer finds love, fantasy and sensual fulfillment with his new girlfriend. Matthew Taylor, Lisa Kudrow.
4:1 MOVIE: The Apartment (Drama) 1960: An ambitious clerk falls in love with his apartment in an attempt to get ahead. Jack Lemmon, Shirley Maizel.
4:45 MOVIE: The Law West of Tombstone (Western) 1938: A former outlaw becomes a force for law and order in a frontier town. Tom Hest, Harry Carey.
5:00 Sports LateNight
5:55 MOVIE: Lovelines (Musical Comedy) 1984: Lead singers from two bands get

a school rivalry and fall in love. Greg Kinnear, Mary Beth Evans. R

TUESDAY November 24

- 2:30 SportsCenter
2:50 MOVIE: Deep Dark Secrets (Mystery) 1987: A woman discovers some shocking secrets about her dead husband. James Brolin, Melody Anderson.
3:00 Sports LateNight
2:50 MOVIE: Battle of Britain (Historical Drama) 1969: British airmen defend their homeland against the Nazis during WWII. Laurence Olivier, Michael Caine. G
4:1 MOVIE: G-Men (Drama) 1935: A young man joins the FBI and goes up against the underworld. James Cagney, Ann Dvorak.
3:00 Up Close
1: MOVIE: The Big Bluff (Mystery) 1955: A greedy man marries a rich woman who only has a short time to live. Robert Hutton, Maitia Vickers.
2: MOVIE: Year of the Gun (Thriller) 1991: A writer's latest book makes him the target of terrorists. Andrew McCarthy, Sharon Stone. R
2:58 Power of the Past With Bill Moyers: Florence Bill travels to Florence and explores the power of the past.
3:1 MOVIE: Grand Canyon Trail (Western) 1948: The friend of a cowboy invests his money in a wildcat mine. Roy Rogers, Charles Coleman.
3:3 MOVIE: Eddie Macon's Run (Action) 1983: An unjustly jailed man escapes from prison and runs for Mexico. John Schneider, Kirk Douglas. R
3:25 MOVIE: New Jack City (Drama) 1991: Two tough cops set out to jail a notorious urban crack dealer. Wesley Snipes, Ice T. R
3:30 American Music Magazine
2: Comedy Club All-Stars VI: Don Rickles introduces Bill Engvall, Carole Montgomery and others.
3: MOVIE: Quarterback Princess (Drama) 1983: A girl disrupts her town when she tries out for high school football. Helen Hunt, Don Murray.
3:55 MOVIE: Fever (Action) 1991: An ex-drug dealer and a lawyer try to save the woman they both love. Anthony Quinn, Sam Neill. R
4:00 MOVIE: Long John Silver (Adventure) 1954: Long John Silver sets out to find treasure and rescue a woman. Robert Newton, Glynis Godfrey.
3: MOVIE: Hardly Working (Comedy) 1981: An unemployed circus clown tries to find a job at other occupations. Jerry Lewis, Susan Dey. PG
3:7 MOVIE: Frenchman's Creek (Adventure) 1944: An English woman falls in love with a French pirate. Joan Fontaine, Rex Harrison.
4:30 Mickey Thompson's Off Road Championship Grand Prix
4: MOVIE: The Soldier and the Lady (Drama) 1937: A courier faces great obstacles as he delivers an important message. Ann Dvorak, Arthur Walbrook.
4:1 MOVIE: The Apartment (Drama) 1960: An ambitious clerk falls in love with his apartment in an attempt to get ahead. Jack Lemmon, Shirley Maizel.
4:45 MOVIE: The Law West of Tombstone (Western) 1938: A former outlaw becomes a force for law and order in a frontier town. Tom Hest, Harry Carey.
5:00 Sports LateNight
5:05 MOVIE: Trouble in Mind (Romantic

Drama) 1985: A principled ex-cop tries to protect two people from corruption. Kris Kristofferson, Keith Carradine. R

5:35 MOVIE: Inner Sanctum (Thriller) 1991: A suicidal woman is stalked by a murderer while being confined to bed. Tanya Roberts, Joseph Bottoms. R

WEDNESDAY November 25

- 2:30 SportsCenter
1: MOVIE: Boyz n the Hood (Drama) 1991: Los Angeles youths try to survive their violent world. Cuba Gooding Jr., Ice Cube. R
2:50 MOVIE: Through Naked Eyes (Thriller) 1983: A couple's voyeuristic game is interrupted by a killer. David Soul, Pam Dawber.
3:00 Sports LateNight
4: MOVIE: Bomba and the Jungle Girl (Adventure) 1952: A jungle youth discovers the skeletons of his long-missing parents. Johnny Sheffield, Sue England.
2:45 MOVIE: The Incredible Mr. Limpet (Fantasy Comedy) 1964: A meek book-keeper turns into a dolphin and helps win World War II. Don Knotts, Elizabeth MarRae.
3:00 Up Close
1: MOVIE: Quigley Down Under (Adventure) 1990: An American sharpshooter is hired to battle Aborigines in Australia. Tom Selleck, Laura San Giacomo. PG-13
2: MOVIE: Gold (Western) 1932: A cowboy finds romance and a gang of murderers while looking for gold. Jack Hoxie, Alice Day.
3:15 MOVIE: Cookie (Comedy) 1989: A gangster's daughter helps him get revenge against his partner. Billy Lloyd, Peter Falk. R
3:30 College Basketball National Invitation Tournament (Semifinal) (R)
4: MOVIE: This Gun for Hire (Drama) 1942: A hired gunman seeks revenge on the man who swindled him. Alan Ladd, Barbara Lark.
3: MOVIE: Across America With Larry Woods Roaming the Outback of California
4: MOVIE: Closet Land (Drama) 1990: A woman accused of subversion is tortured by a totalitarian state. Madeline Stowe, Alan Rickman. R
4:00 MOVIE: Lovell in the City of Kings (Drama) 1978: A 13-year-old girl learns a lesson in life when she falls in love. Denise Miller, Rex Gentry.
3:7 MOVIE: The Hired Hand (Western) 1971: A drifter returns to his wife and daughter after seven years. Peter Fonda, Warren Oates. PG
4:1 MOVIE: Bomba and the Golden Idol (Adventure) 1954: Bomba the jungle boy goes in search of a lost golden idol. Johnny Sheffield, Anne Kirkbride.
4:25 MOVIE: Velvet Dreams (Drama) A writer is unwilling to end a destructive relationship. Bill Bixby, Kathy Shower. R
4:30 MOVIE: The Incredible Shrinking Woman (Comedy) 1981: A housewife shrinks after using an experimental household product. Jaye Poppel, Charles Grodin. PG
4:45 MOVIE: Staying Together (Comedy) 1989: Family unity is threatened when a father sells his business. Sean Astin, Sherry Channing. R
4:55 MOVIE: Robbers of the Range (Western) 1941: A rancher is pitted against an unscrupulous band of



NIGHT OWL LISTINGS

FROM 2:30 a.m. to 6:00 a.m.

- crooks. *The Hit* Ray Atchay
- 5:00 **11** MOVIE: *The Way We Were* (Drama, 1973). An unlikely love grows between two completely different people. *Darla Strevant*, Robert Redford. PG
- 20** Sports LateNight
- 5:05 **11** MOVIE: *Stranded* (Science Fiction, 1987). A girl and her grandmother are held hostage by a group of aliens. *Lee Skye*, Joe Martin. PG-13
- 5:30 **11** MOVIE: *Sabu and the Magic Ring* (Fantasy Adventure, 1958). A boy is pursued by an evil caliph after he finds a magic ring. *Sabu*, Bina Massey.
- 5:55 **17** MOVIE: *Dance With Death* (Thriller, 1991). An ambitious reporter poses as a stripper on the Sunset Strip. *Melanie Lynskey*, Barbara Ann Woods. R

THURSDAY November 26

- 2:30 **20** SportsCenter
- 20** **50** MOVIE: *The Idolmaker* (Drama, 1980). A young man uses his talents to turn teenager's into rock stars. *Ray Sharkey*, Tovah Feldshuh. PG
- 20** Sports LateNight
- 11** MOVIE: *The Vengeance of She* (Science Fiction, 1968). A ruler awaits the return of the queen he hopes to immortalize. *Sheela*, Bevis. *John Richardson*. G
- 2:40 **17** MOVIE: *Desire* (Romantic Drama, 1990). A music student finds love and passion in Italy at carnival time. *Peter Marc*, Gaby Ford. R

- 3:00 **11** MOVIE: *The Long Walk Home* (Historical Drama, 1990). In 1955 a housewife and her maid face difficult choices. *Jessy Spanek*, *Whitney Jackson*. PG
- 27** **56** Mystery! Two murders confirm that a mad ABC murderer is on the loose. (Pt. 2)
- 20** **62** MOVIE: *The Girl Who Came Back* (Mystery Drama, 1935). A girl fights her way from the underworld into high society. *Sidney Blackmer*, *Neil McKinn*.

- 3:05 **11** MOVIE: *Buffalo Bill* (Biography Drama, 1944). William Cody works to form peaceful relations with the Indians. *Lee McCrea*, *Linda Gardner*.
- 3:25 **11** MOVIE: *Two Evil Eyes* (Horror, 1990). Two acclaimed horror directors adapt classic Edgar Allan Poe stories. *Hatya Kenter*, *Adrienne Barbeau*. R
- 3:30 **11** College Football Texas A&M at Texas (R)
- 20** MOVIE: *Tulsa* (Drama, 1949). A woman's newfound wealth jeopardizes her chances for happiness. *Barbara Rayward*, *Robert Preston*.

- 4:00 **21** **62** MOVIE: *Love in the Present Tense* (Romance, 1982). A woman struggles to recover from a life shattering experience. *Maria Perini*, *Michael Supraman*.
- 20** MOVIE: *24 Hours to Kill* (Adventure, 1965). Two pilots become involved with a murderous band of smugglers. *Maxey Roemer*, *Jim Baker*.
- 17** MOVIE: *Pool of London* (Drama Adventure, 1951). A sailor gets away with smuggling until he gets involved in murder. *Joan Shaw*, *Boyd Campbell*.

- 4:10 **17** MOVIE: *My Man Adam* (Comedy, 1985). A boy meets his fantasy girl but suspects her of a crime. *Rachael Knight*, *Leslie L. Lyles*. R
- 11** MOVIE: *The Rocketeer* (Action Fantasy Adventure, 1991). A pilot finds an experimental rocket pack that allows him to fly. *Bill Campbell*, *Alan Arkin*. PG-13

- 4:30 **11** MOVIE: *From Hell It Came* (Science Fiction, 1957). Two American doctors in Africa meet the dreaded Tabango monster. *Ted Andrews*, *Tina Carver*.
- 4:35 **11** MOVIE: *Blood on the Moon* (Western, 1948). A cowboy suddenly changes his underhanded ways to help a woman. *Robert Mitchum*, *Barbara Bel Geddes*.
- 4:45 **11** MOVIE: *The Phantom Thief* (Mystery, 1946). Boston Blackie tries to recover some jewels from a spiritualist. *Chester Morris*, *Jeff Donnell*.
- 5:00 **20** Sports LateNight
- 5:30 **11** MOVIE: *Nakia* (Drama, 1974). An American Indian sheriff is torn between duty and ancestral pride. *Robert Forster*, *Arthur Kennedy*.
- 5:40 **17** MOVIE: *The Chinese Connection* (Adventure, 1973). A kung-fu expert gets revenge for the murder of his teacher. *Bruce Lee*, *Miao Xei Hsu*. R

FRIDAY November 27

- 2:30 **20** SportsCenter
- 20** **50** MOVIE: *The Treasure of Jamaica Reef* (Adventure, 1974). Two divers seek to recover gold lying at the bottom of the Caribbean. *Chevy Chase*, *Stephen Boyd*. G
- 27** **56** MOVIE: *The Private Life of Don Juan* (Adventure, 1934). Swashbuckling Don Juan fakes his own death and attempts a new life. *Douglas Fairbanks*, *Marie Oberon*.
- 11** MOVIE: *Grizzly* (Horror, 1976). A park ranger finds himself pitted against a mammoth grizzly bear. *Christopher George*, *Andrew Prine*. PG
- 20** Sports LateNight

- 2:45 **11** MOVIE: *My Favorite Spy* (Comedy, 1951). A burlesque comic masquerades as an international spy. *Bob Hope*, *Reddy Jamar*.
- 3:00 **10** Up Close
- 10** MOVIE: *The Roaring Twenties* (Drama, 1939). Three WWI buddies return home and get involved in a bootleg racket. *James Cagney*, *Humphrey Bogart*.
- 21** **62** MOVIE: *Get Along Little Dogies* (Western, *Gene Autry*, *Smiley Burnette*.
- 20** MOVIE: *Recruits* (Comedy, 1985). Police recruit a group of goofballs in order to discredit the mayor. *Alan Rickman*, *Anne M. Gray*.

- 3:05 **11** MOVIE: *Physical Evidence* (Suspense, 1989). A cop tries to prove his innocence after he is arrested for murder. *Burt Reynolds*, *Theresa Russell*. R
- 3:30 **11** College Football Louisiana State at Arkansas (R)
- 3:40 **11** MOVIE: *The Doors* (Biography Drama, 1991). Rock performer Jim Morrison struggles with his own dark side. *Val Kilmer*, *Meg Ryan*. R
- 3:45 **11** MOVIE: *Get Smart, Again!* (Comedy, 1989). Maxwell Smart and Agent 99 confront the evil K.A.O.S. agents. *Mike Myers*, *Barbara Feldon*.

- 3:55 **17** MOVIE: *Howling VI: The Freaks* (Horror, 1991). Evil forces surround the freaks in a traveling carnival sideshow. *Brendan Hughes*, *Melissa Matheson*. R
- 4:00 **21** **62** MOVIE: *Marisol* (Romantic Comedy, 1982). A servant girl falls for a successful Los Angeles architect. *Angela*, *James Farentino*. *Indira*.
- 20** **20** MOVIE: *Doctor Franken* (Drama, 1979). A surgeon is rumored to be a descendant of Dr. Frankenstein. *Robert Vaughn*, *Teri Garr*.
- 11** MOVIE: *They Came to Rob Las Vegas* (Suspense, 1968). Members of a

- criminal gang plan to rob an armored car. *Gary Lockwood*, *Lee Summer*. R
- 17** MOVIE: *The Forty Eight Hour Mile* (Drama, 1970). A private investigator uses dirt and deception to serve a subpoena. *Dan Aykroyd*, *William Weston*.
- 4:10 **11** MOVIE: *The Outlaws is Coming* (Comedy, 1965). Three bandits head west to stop the slaughter of buffalo. *Larry Fine*, *Mae Kuwata*.
- 4:30 **11** MOVIE: *Career* (Drama, 1939). A generous small-town shopkeeper extends warmth to those around him. *Edward G. Robinson*, *Ann Stuenkel*.
- 11** MOVIE: *It! The Terror From Beyond Space* (Science Fiction, 1958). A spaceship returns from Mars bearing a monstrous stowaway. *Marshall Thompson*, *Shirley Stiles*.

- 4:50 **11** MOVIE: *The Pope Must Die* (Satire, 1991). A somewhat unethical priest is mistakenly elected pope. *Ricci Martin*, *Beverly S. Angelo*. R
- 5:00 **11** MOVIE: *Confessions of Boston Blackie* (Mystery, 1942). A priceless statue is replaced with a copy that has a corpse inside. *Chester Morris*, *Harriet Harlow*.
- 21** **7** MOVIE: *The New Adventures of Pippi Longstocking* (Adventure, 1988). Pippi awaits the return of her missing sea-faring father. *Tina Turner*, *Ernest Borgnine*. G
- 20** Sports LateNight

SATURDAY November 28

- 2:30 **11** Motoworld
- 20** **62** Stingers Main Event
- 20** Sports LateNight
- 2:35 **17** MOVIE: *Age of Consent* (Drama, 1969). An artist flees New York City for the solitude of Australia. *Jenny Marsden*, *Heidi Marnet*. R
- 21** MOVIE: *Warlock* (Fantasy Adventure, 1989). An evil warlock seeks a book that can destroy the world. *Jack Palance*, *Joe Sayer*. R

- 3:00 **11** College Football (R)
- 11** MOVIE: *Whoopie!* (Musical, 1930). A timid man has a series of wild adventures. *Johnnie Walker*, *Edward G. Robinson*.
- 11** MOVIE: *Company Business* (Drama, 1940). An ex-CIA agent and a former KGB mole must work together to survive postwar Berlin. *Max Baer*, *Shirley Ross*. PG-13
- 21** **4** MOVIE: *It's a Wonderful Life* (Drama, 1946). A guardian angel visits a man who's contemplating suicide. *James Stewart*, *Donna Reed*.
- 20** MOVIE: *Party Camp* (Comedy, 1987). Competition takes a wild turn as the nerds take on the jocks. *Andrew Ross*, *Kerry Shivers*. R

- 3:30 **21** **7** MOVIE: *Mr. Reeder in Room 13* (Mystery, 1945). A cultured English gentleman tracks a counterfeiting ring. *John H. Johnson*, *Paula Patton*.
- 21** **62** MOVIE: *Matter of the Heart* (Drama, 1982). A ballerina falls for a string-wired orchestra leader. *Walter Aale*, *Shirley*.
- 11** MOVIE: *From the Earth to the Moon* (Science Fiction, 1958). Three men and a woman travel to the moon in a futuristic rocket ship. *James Earl Ray*, *George Kennedy*.
- 20** MOVIE: *Two of a Kind* (Comedy, 1983). Two misused engineers must prove the world is not irreparably corrupt. *John Travolta*, *Julia Roberts*. PG-13

- 3:35 **21** **2** MOVIE: *Crossbow: The Adventures of William Tell* (Adventure, 1989).



NIGHT OWL LISTINGS

FROM 2:30 a.m. to 6:00 a.m.

- Tell and a band of mercenaries try to rescue his imprisoned son. *Will Lyman*, *Jeremy Clyde*.
- 11** MOVIE: *Piranha* (Horror Comedy, 1978). A resort area is plagued by attacks from man-eating fish. *Bradford Dillman*, *Heather Menzies*. R
- 3:40 **11** MOVIE: *Postcards From the Edge* (Comedy Drama, 1990). A successful actress tries to overcome her dependency on drugs. *Meryl Streep*, *Shirley Maclaine*. R
- 4:00 **20** **20** MOVIE: *Defense of the Realm* (Thriller, 1985). An ambitious reporter learns of a British political conspiracy. *Gabriel Byrne*, *Greta Scacchi*. PG
- 17** MOVIE: *The Overlanders* (Adventure, 1946). Cattlemen make a drive across Australia as World War II threatens. *Chips Rafferty*, *Daphne Campbell*.

- 4:15 **17** MOVIE: *Pet Sematary* (Horror, 1989). A doctor learns the strange powers of an Indian burial ground. *Dale Midkiff*, *Fred Gwynne*. R
- 4:20 **11** MOVIE: *Dollman* (Science Fiction, 1991). A 13-inch-tall lawman chases an alien criminal to Earth. *Tim Thomerson*, *Jackie Earle Haley*. R
- 4:45 **9** MOVIE: *Armored Car Robbery* (Mystery, 1950). A policeman seeks gang members who killed his friend during a holdup. *Charles McGraw*, *Robert Sterling*.
- 10** MOVIE: *Four Daughters* (Drama, 1938). Four small-town sisters face romantic entanglements. *Claude Rains*, *Rosemary Lane*.

- 5:00 **20** MOVIE: *Charlie Chan in Murder Over New York* (Mystery, 1940). Charlie Chan seeks a killer on a plane trip to New York. *Sidney Toler*, *Marjorie Weaver*.
- 20** Sports LateNight

- 11** MOVIE: *The Invisible Invaders* (Science Fiction, 1959). A scientist is visited by an invisible being from the moon. *John Agar*, *Jean Byron*.
- 11** MOVIE: *Frog* (Drama, 1988). A smart boy has more luck with his pet reptiles than girls. *Shelley Duvall*, *Elliott Gould*.
- 5:25 **11** MOVIE: *A Place to Call Home* (Drama, 1987). A woman moves with 11 children to a remote Australian sheep ranch. *Linda Lavin*, *Lane Smith*.
- 5:30 **21** **62** MOVIE: *Frontier Pony Express* (Western, 1939). The Pony Express battles a ruthless senator. *Roy Rogers*, *Mary Hart*.

SUNDAY November 29

- 2:30 **20** Sports LateNight
- 11** MOVIE: *The Rocketeer* (Science Fiction Adventure, 1991). A pilot finds an experimental rocket pack that allows him to fly. *Bill Campbell*, *Alan Arkin*. PG-13
- 2:50 **21** MOVIE: *Def by Temptation* (Horror, 1990). A minister tries to save a friend from a woman possessed by a demon. *James Bond III*, *Kadeem Hardison*. R
- 3:00 **11** College Football (R)
- 11** MOVIE: *American Ninja 3: Blood Hunt* (Martial Arts, 1989). A martial-arts master fights an evil businessman. *Steve James*, *Marjoe Gortner*. R
- 27** **56** Masterpiece Theatre: *The Assistant*. Commissioner confronts Verloc. (Pt. 3 of 3)
- 3:15 **9** MOVIE: *Sullivan's Travels* (Comedy Drama, 1941). A movie director disguises himself as a bum and goes on the road. *John McCrea*, *Veronica Lake*.

- 11** MOVIE: *The Teahouse of the August Moon* (Comedy, 1956). An Army captain attempts to rehabilitate a war-torn town in Okinawa. *Marlon Brando*, *Glenn Ford*.
- 3:30 **17** MOVIE: *Assault of the Party Nerds* (Comedy, 1989). The members of Lambda Alpha Eta decide to change their nerdy image. *Linnea Quigley*, *Troy Donahue*. R
- 3:50 **11** MOVIE: *... And Justice for All* (Drama, 1979). A veteran lawyer battles the judicial system. *Al Pacino*, *Jack Warden*. R
- 4:00 **21** WCW Main Event Wrestling
- 20** Sporting Life With Jim Huber
- 17** MOVIE: *The Bowery Boys Meet the Monsters* (Comedy Mystery, 1954). The Bowery Boys become trapped in the house of a mad genius. *Leo Gorcey*, *Bernard Gorcey*.
- 4:20 **11** MOVIE: *The Apple Dumpling Gang* (Comedy, 1975). A gambler and three orphans become involved in a bank robbery. *Bill Bixby*, *Susan Clark*. G
- 4:25 **21** MOVIE: *A Time to Die* (Action Drama, 1991). A photographer is stalked by a cop she saw committing a murder. *Traci Lords*, *Jeff Conaway*. R
- 4:30 **10** MOVIE: *The Best Man* (Drama, 1964). Leading presidential contenders vie for an important endorsement. *Henry Fonda*, *Cliff Robertson*.
- 4:50 **9** MOVIE: *Blind Adventure* (Mystery, 1933). An American blunders into a London mansion and finds a mystery. *Ralph Bellamy*, *Robert Armstrong*.
- 4:55 **17** MOVIE: *Pyrates* (Fantasy Comedy, 1991). Two lovers encounter a volatile problem. *Kevin Bacon*, *Kyra Sedgwick*. R
- 5:00 **20** Sports LateNight

WORLD STEAIRICH

S U S U R U A S O H T Y R O C
 A T K M S U C O D O L P I D E
 B R O N T O S A U R U S T E P
 D I N O B O N R H O D A N I T
 F C S T E G O S A U R U S N O
 R E E P G O D Z I L L A T O P
 O R C O E L O P H Y S I S N T
 T A Q B U R N S H O P E Q Y E
 P T E R O D A C T Y L J U C R
 A O A S U R U A S O L L A H Y
 R P R O Y A G L A B R E A U G
 H S L Z O T I R E A G A N S I
 A X S U R U A S O M S I E S U
 T Y R A N N O S A U R U S W S
 U S U L T A O C L A Z T E U Q

Dinosaurs

- | | | |
|---------------|----------------|---------------|
| Allosaurus | Deinonychus | Seismosaurus |
| Brontosaurus | Diplodocus | Stegosaurus |
| Ceopterygius | Iguanodon | Triceratops |
| Coelophysis | Pterodactyl | Tyrannosaurus |
| Corythosaurus | Quetzalcoatlus | Utahraptor |

Cable / TV Weekly

is published every Monday by the Suburban Communications Corporation, 36251 Schoolcraft Road, Livonia, MI 48150.

All advertising published in the *Cable / TV Weekly* is subject to the conditions stated in the applicable rate card, copies of which are available from the Sales Manager at Specialty Publications, 24445 Drake Rd., Farmington Hills, MI 48335 or call 478-5160. Suburban Communications Corporation reserves the right not to accept an advertiser's order.

Advertisers have no authority to bind *Cable / TV Weekly* and only publication of an advertisement shall constitute final acceptance of the advertiser's order. The information in *Cable / TV Weekly* is provided by the networks and stations. *Cable / TV Weekly* is not always notified of changes prior to going to press. All program schedules are subject to change. To advertise, call 478-5160, Monday-Friday between 8:30 am and 5:00 pm. Copy deadline is 5:00 pm Friday, 10 days before publication.

IT'S HERE FOR YOU!

The Sci-Fi Channel. Science fiction, fantasy and classic horror. All in one place...only on cable. 24 hours a day of blockbuster films, all-time favorite television series and the most original new programming in the universe. The Sci-Fi Channel is here for you. Come aboard for the voyage of a lifetime.



Omnicom Cablevision
Introduces the **SCI-FI Channel.**
See it on Channel #32.

OMNICOM
CABLEVISION

© 1992 OMNICOM CABLEVISION

459-7300