

Vigil, memorial dedication is July 3-4...see pg. 3

50¢



The Community Crier

The Newspaper with Its Heart in The Plymouth-Canton, MI Community

Vol. 16 No. 21

©PCCC Inc.

June 28, 1989

Celebrating P-C's forgotten 'heroes'



BY KEN VOYLES

"It was 20 years ago today," and while Sgt. Pepper played, war in Vietnam raged.

The year was 1969 and young Americans everywhere were still being called, or drawn, to battle as they had been since before 1964. They came from every village, township and city in this country, including Plymouth-Canton.

More than 372,000 men and women were summoned or volunteered from Michigan alone (from 1961-73) to fight in a conflict that was never officially declared a war. Of those, 2,579 were killed and another 13,452 wounded. There are also reports of at least 75 Michigan men unaccounted for to this day.

The conflict touched the lives of Plymouth-Canton families directly as young men from the community went off to serve "in country" in a place as strange and terrible sounding as its name -- Vietnam.

Please see pg. 8

July 4th parade Tuesday

BY LAUREN SMITH

This year's Fourth of July parade, complete with a new route and a diverse group of participants, is sure to spread patriotic spirit through The Plymouth-Canton Community.

Especially since it is the only parade in Plymouth-Canton this year. (The annual festivities in Canton -- the Country Festival -- were replaced by the Canton Challenge Festival held around Memorial Day.)

The theme for this year's parade is "Volunteerism in America." It is a salute to Plymouth's community service clubs and organizations.

Please see pg. 20

Canton's Harry Zebony, the most decorated soldier from Plymouth-Canton killed in Vietnam, is seen in the photo at top. Above, Plymouth youth, Richard Newry, who was also killed in Vietnam.

CARTER Lumber

BUY DIRECT
LOAD DIRECT

665-5531

FIBER-CLASSIC
THERMATRU

French Patio Door System

- Exquisite 15-facet beveled glass-insulated, tempered, double strength solid insulating core with foamed-in-place glass-eliminates air/water infiltration
- 25 yr. warranty; 5 yr. warranty on glass

6'0" x 6'8" \$ 695.99

6' PICNIC TABLE KITS

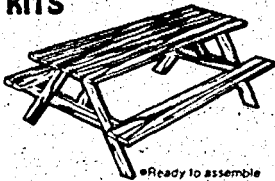

SELECT GRADE
SOUTHERN YELLOW
PINE
SPT4

\$ 18.95

EXCITING with savings

BUY 5 - GET THE 5th GALLON... FREE

Purchase 5 gallons of any combination of Olympic products listed below, then send in a rebate coupon for a refund of the purchase price of 1 gallon.

See our nearest store for Complete Details!

OFFER GOOD JULY 1 thru JULY 31, 1989

- OIL STAIN Solid or Semi-Transparent \$12.99
- OVERCOAT \$13.99
- LATEX STAIN \$12.99
- DECK STAIN \$15.99
- WOOD PRESERVATIVE Clear \$10.99



VINYL ACRYLIC LATEX HOUSE PAINT

- Dover white
- Clean-up with soap & water
- Economical

2 Gal. \$ 13.99



GUTTER-TITE™

- Butyl rubber sealant that remains flexible and bonds on aluminum

\$ 2.29 #GT-125 10.5 oz

Driveway SEALER

- Tar pitch emulsion seals, protects & beautifies asphalt pavement

\$ 7.65

FILLER & SEALER

- Seals and fills minor voids & cracks

\$ 8.99



RAINGO VINYL GUTTER

- 10' Length
- Vinyl Snap Together

\$ 2.99

KITCHENS & BATHS

Gaylan Oak Cosmetic Cabinet combined with matching **MKTOR and LEBITE** creates a unique and beautiful look.

- #732-D (30") \$ 88.95
- #712-D (30" x 26") \$ 78.95
- #645-D (30") \$ 122.95



Furniture Quality Unity

- Superior construction and materials
- Solid Oak drawers
- Hand rubbed furniture finish

#532-D (30" x 21")

\$ 262.95

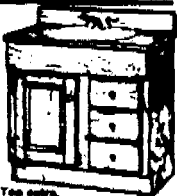

ONE PIECE TUB & SHOWER MARS II

- Chromium plated stainless steel
- Change accessories & grab bar
- Slip resistant floor

\$ 199.95

White #6677-73

Color \$ 299.95

TWO PIECE TUB & SHOWER MARS II

- See personal unit for availability
- of complete bathroom remodeling
- changing accessories and plans

\$ 289.95

Color \$ 299.95



BATHROOM

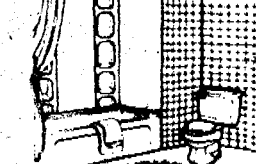

ATLAS TOILET	WHITE	\$ 49.95	\$ 63.95
WALL MOUNTED		\$ 49.95	\$ 49.95
ACRYLIC BATHTUB		\$ 99.95	\$ 99.95

New Castle TOILET

\$ 89.95

PRIOR SALES EXCLUDED. PRICES GOOD THROUGH JULY 11.



HOURS

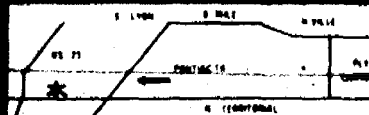

Following tests Officials: 'Sherwood is safe'

BY JOHN BRODERICK

Despite the continuing concerns of residents of Canton's Sherwood Mobile Village, state and county health officials have said the park is safe, and that there is no immediate health hazard apparent.

The residents have complained to park owners and health officials that the soil and water at Sherwood is contaminated — either because of an old landfill on the site, or an old underground septic system that was never removed.

Some residents have been withholding rent payments, and placing them into an escrow account, until changes are made at the park.

But a spokesperson for Sherwood Village said that there is no problem.

"As soon as we heard the complaints, we hired the Techna Corporation to go out and test the soil at the park," said Janet Swistak, an attorney representing Sherwood Village Association, Ltd., which owns the park.

"They were there for 10 days during June, testing the drinking water and the soil. They found that the drinking water is well within the requirements of the Federal Safe Drinking Water Act.

"They also found that soil samples taken from Sherwood are representative of normal Michigan soil — they did not find any indication that sewage, waste, or by-products were present, or that there was any health

Please see pg. 40

MSP investigating officer

BY JOHN BRODERICK

Michigan State Police are investigating allegations that a Plymouth Township police sergeant was involved in a brawl with a resident while he was off-duty.

Plymouth Township Police Chief Carl Berry has also said that four 17-18 year-old Plymouth-Canton men are being charged with obstructing and hindering police in connection with the scuffle that occurred at a gathering in a township neighborhood last Monday.

"There have been allegations made about a police officer. The State Police are conducting an investigation, and

that's all I know at this point," Berry said.

The officer's account of the incident differs significantly from those of the four men — each saying that the other was hostile and used profanity, according to police reports.

According to official reports, the four, and a number of other people came to a home near that of the officer, expecting a party.

They realized there was none and were deciding where to go, when the officer came out of his house, words were exchanged, and a scuffle broke out between the officer and one of the men, township police reports said.

After on-duty officers arrived and attempted to arrest the man wrestling with the officer, the other three shouted at the officers, and refused to leave the scene, according to police reports.

The four were issued tickets for obstructing and hindering police, and have been assigned court dates at 35th District Court, Berry said, adding that the officer remains on active duty while State Police investigate the incident.

"The State Police have been and will be interviewing each of the officers involved that evening," Berry said.

Officers at the Northville Branch of the State Police declined to discuss the investigation.

Please see pg. 40

Don Chudzinski, president of a tenant's group at Sherwood Village Mobile Park inspects a pool of standing water near his home. Chudzinski has complained about poor drainage which he says is causing health problems at the park. (Crier photo by Chris Farina)



Vigil, dedication July 3-4

BY KEN VOYLES

This year's July 4th holiday is a special one in The Plymouth-Canton Community.

At 11 a.m. on Tuesday, a memorial monument will be dedicated in Plymouth's Kellogg Park honoring those local men and women who served in the Korean and Vietnam conflicts, including one soldier who died in Korea and seven who died fighting in Vietnam.

Before the dedication, an around-the-clock vigil by an honor guard of local veterans will begin about 3 p.m. on Monday (July 3).

The honor guard will watch over the shrouded memorial until the dedication ceremony on the 4th.

The memorial dedication will last about 45 minutes and include wreath

laying and music by the Plymouth Fife and Drum Corps, a 21-gun salute and several short dedication speeches by Michigan veterans of Korea and Vietnam.

Some of the families of those who were killed will be on hand for the ceremony, said Fred Brunk, of the Plymouth Vietnam Veterans Association (PVVA), which organized and sponsored the memorial project.

"We're inviting everyone to this," said Brunk, who added that a flag pole

will be in place at the monument location (the corner of Union Street and Ann Arbor Trail) for the ceremony.

The monument itself includes a centerpiece with an Eagle and Dove stationed above and below an inscription. The two wings of the monument will include the carved

McClendon resigning?

BY JOHN BRODERICK

Long time school board member E.J. McClendon has said there is no truth to the rumor that he will resign his seat on the Plymouth-Canton Community Schools Board of Education.

"I think that rumor started because of a conversation I had with someone about my taking over the presidency of the Plymouth Rotary on July 1," McClendon said.

Please see pg. 40



Getting ready

First of America employees (from left) Margaret Slomk, Holly White and John Glodich, prepare their float for Tuesday's July 4th parade. See pg. 20 for more details. (Crier photo by Chris Farina)

Crier deadlines

Due to the upcoming holiday, the deadlines for the July 5th edition of The Crier will be changed.

The deadline for all classifieds will be Friday (June 30) at 4 p.m. Display advertising will be due on Friday (June 30) at 3 p.m.

Editorial materials must be received by noon on Thursday (June 29).

The Crier office will be closed on Tuesday, July 4.



Community opinions

The Community Crier



THE
NEWSPAPER
WITH ITS
HEART IN THE
PLYMOUTH-
CANTON COMMUNITY

821 Penniman Ave.
Plymouth, MI 48170
(313) 453-6900

EDITOR & PUBLISHER:

W. Edward Wendover
GENERAL MANAGER:
Phyllis Redfern
MANAGING EDITOR:
Ken Voyles

REPORTERS:

John Broderick
Lauren Smith

SPORTS REPORTERS:

Janet Armstrong
Rita Derbin

INTERN:

Robin Lake

PHOTOGRAPHER:

Chris Farina

BUSINESS MANAGER:

Peg Glass

BUSINESS ASSISTANT:

Margaret Glomski

CIRCULATION MANAGER:

Verna Hogle

OFFICE & CIRCULATION

ASSISTANT:

Kathe Allison

ADVERTISING DIRECTOR:

Michelle Tregembo Wilson

ADVERTISING

CONSULTANTS

Peg Paul, Jack Armstrong,

Angie Predhomme, Beth

Bruce

PUBLISHED EACH WEDNESDAY
by The Plymouth-Canton Community
Crier, Inc.

CARRIER DELIVERED
\$1.75 monthly, \$20 yearly
U.S. MAIL DELIVERED: \$30 yearly
in U.S.A.



Recycle
your
newspapers!



A complete publishing company
345 Fleet St., Plymouth, MI 48170
(313) 453-6860

SALES DIRECTOR:

Andy Vafakas

PRODUCTION MANAGER:

Dale Mickelson

GRAPHIC ARTISTS:

Shawn Guideau

Leslyn A. Rank

TYPESETTER:

Rita Derbin

Remembering Vietnam: emotions still alive

This one is for the families of those soldiers who were killed in Vietnam and Korea.

Even in peace we are at war with ourselves -- at war with the raw emotions which wars bring to the surface, especially for the families who lost a son or brother in the fighting.

After interviewing most of the families about their sons -- who will be honored on July 3-4 during the memorial monument dedication -- it became clear that those raw emotions are still very much alive.

Karry Langcaster, sister of James Patrick Eckles who died in Vietnam, put it best.

"There are a lot of human emotions involved in this and a lot of people don't look at that," she said. "When I started working on this project I had a need to give something back to somebody I loved an awful lot, and it's kind of my way of showing how proud I am of him even now and how much I miss him."

"It's been so long since someone was killed there that people forget there is pain involved. It's not a pain you can set aside.

"It's a pain you have to learn to live with and it never stops hurting."

Mike Eckles, Pat's twin brother, said, "I forget and then I go through the letters and it all comes back. I don't know if time heals wounds. Ten years ago I couldn't have done this." . . .

Many of the families remain bitter to this day over the loss of those young men in Vietnam and Korea. Others have resigned themselves to the facts,

CBE stances can help in other way

Sharing the wealth

After two weeks of analyzing the Plymouth-Canton School election results, a new idea has been proposed by school officials.

It's not that they're tired of hearing the Citizens for Better Education (CBE) rhetoric -- and wasting time trying to accommodate their complaints within the procedure -- it's just that the school folks would like to share the wealth.

The CBE was trounced.

Sure, its candidate garnered 3,166 votes. (Although, it can also be argued that some of those were simply voters who cast "no" votes on the two millages as well. There were 4,275 "nay" sayers on the renewal, and 6,666 who voted "no" on the increase.)

But the CBE's convoluted attacks were what actually passed both millage questions.

Record numbers of voters -- including some who hadn't turned out for school votes in years -- gave the schools an overwhelming vote of confidence because the CBE-types were trying to take over.

Now, for the public good...

The Plymouth-Canton Schools supporters -- students, staff, parents and others -- have of-

In the margin

By Ken Voyles



and try to remember only the good things about their sons or brothers.

This memorial project has not been an easy one -- it's not been easy on the families who were interviewed, and it's not been easy on me. Rehashing painful memories is never as simple as it might seem and writing about war holds no glamour or romance.

But today I feel like I know all of the local men who died in Korea and Vietnam, and I feel the loss of those families. It comes from sitting down with them for hours at a time trying to piece together a portrait of who those soldiers really were.

Wayne Cummins, a close friend of Butch Sarah's said: "There couldn't be a guy more deserving. He's somebody I'll never forget. He allowed patriotism to supercede his philosophical beliefs and what did it get him? That's the sad part."

"I don't know if I'm bitter, but I regret that it was such a wasted war," said May Sarah. "We didn't settle anything."

Vickie Wilson, who was married to Butch Sarah said she will "always" be bitter.

"Yeah, there's bitterness," said Donald Zalesny, brother of Harry Zalesny, "bitterness at the wasting of all those lives."

"I'm not bitter about the war," said Denise Murphy who was married to Pat Eckles. "No one wanted to be drafted, but Pat felt his obligation to go."

Irma Larrick, mother of Dick Larrick, said, "I just try and look on the bright side of things." Larrick's sister Bonnie Hammond said, "It was so useless that so many young people died. I suppose there is some bitterness because I lost someone very close."

"It takes a long time and still you never forget," said Ken Nowry, father of Richard Nowry.

I feel a little like John Pappas, the man who really made this memorial happen and the one who should be given a great big thanks for the effort.

Pappas, who also served in Vietnam, told me that after the dedication Tuesday his work will be done and he will be able to once again get on with his own life, having successfully given Plymouth-Canton a place to honor the dead (and living) from Vietnam and Korea.

I'll try and do the same, though I really suspect that my life may never be the same.

It is just too hard to forget the tears of those family members I talked with; today I cry with them.

with Malice Toward None



ferred the following CBE stances for the good of the community:

CBE SUPPORT --

City of Plymouth pigeons.

More Canton strip malls.

High rise buildings.

The--Detroit newspapers' Joint Operating Agreement.

Another level above the Fleet Street parking deck.

CBE OPPOSITION --

A railroad underpass at Sheldon Road.

Plymouth City and Township unification.

Solid waste planning.

State education finance reform.

Clean-up of the Rouge River; Phoenix, Wilcox and Newburg Lakes; Hines and Holliday Parks.

Motherhood, apple pie and the American flag.



Community opinions

PG. 5 THE COMMUNITY CRIER: June 28, 1989

Voyles prejudiced, bigoted

EDITOR:

Does this alleged writer in your paper, Ken Voyles, think what he writes makes any sense? He appears to be prejudiced against dissenters and bigoted against religion. I refer to his column of June 14, "CBE Bashing -- For The Record."

I am not a resident of Plymouth or have any connection with CBE, but what I read is disgusting and without logical content.

Apparently he is so prejudiced against any who disagree with the present acts of the Plymouth-Canton schools he can't stand opinions of those who show quality interest in clean, basic education.

Why the reference to George Bush and alleged "dirty tricks?" More prejudice, and not backed by the majority of U.S. voters!

I don't even know Mrs. Daskalakis, but she deserves much more respect than this unbelievable writer is willing to give.

WILLIAM HOGG

Crier's CBE coverage continuously slanted, one-sided

EDITOR:

I am so tired of reading the never-ending reporting on everything and anything CBE or Diane Daskalakis does. I, for one, find The Crier's coverage as a continuous, slanted and one-sided attack.

Is this all you can find of interest in the Plymouth-Canton area to report about? Also, in your quest to inform us, why have I read little or nothing of the fact that when the school district goes "out-of-formula" within the next one to two years, the money the schools are now in need of will begin to be replaced? Isn't that important?

I am not a member of CBE, nor do our theological points of view coincide on all matters, but here are some points to consider:

CBE, or Diane Daskalakis, have affected change in school policy. Is that bad? If nothing needed a second look and everything is just fine, why the changes? She has had the courage to stand up and do something about the things she strongly believes in. Whether you agree with her or not, she has caused the community to look at the schools and think about our school system.

She has increased public awareness. Apathy and disinterest are more dangerous than the threat she supposedly poses, and if eliminating R-rated movies and newspapers with offensive humour and sexual advertisements from our classrooms is labeled "censorship," I guess I am for it. Does everything and anything belong in our schools? I don't think anyone believes that.

I don't believe CBE is saying all the teachers and everything being taught at our schools is bad. Personally, I have had some very positive experiences with many of our teachers and administrators and so has she. They have been responsive and courteous to me in almost every instance and having 4 children currently in the schools and I

graduated from Salem, I have had alot of contact with the schools; but is showing concern about school policies and objecting to some practices wrong? I don't think so. I feel it is a healthy sign of community involvement and interest.

Did you know for instance, that the Plymouth-Canton School District has one of the highest rates of private complaints at the state Board of Education in Lansing? Why? I am personally aware of two public school teachers who send their children to a local private school. Why?

Are you also aware of the fact that the group you label as a "small band of conservative Christians" consists of more than 2,500 people from the Baptist, Lutheran, Presbyterian, Assembly of God, Church of Christ and Catholic faiths? Hardly a "small band of conservative Christians!" Some of these 2,500 people are even teachers.

With respect to the meeting of the pastors and ministers and the letter they signed concerning CBE, are you aware that they represent only 12 of the 50 churches in the area and that only one of those signing the letter had ever received a presentation or explanation of CBE's goals and the facts behind the group's formation?

Also, some of the ministers present refused to sign that letter. Why didn't you report that? Another interesting point for you and the ministers who did sign -- of the eight pastors who have taken the time and interest to look into CBE's goals and facts (not rumours), seven are now 100 per cent behind them. Maybe the 14 Christian authors of the letter should have given more time to research of the subject of their letter and the courtesy of allowing their "accused" to defend herself and CBE before deciding to condemn. When my Catholic pastor signed that letter with so little information, he did not sign as my representative.

Swimming upstream

by John Broderick



Claudia Kulnis has a tough act to follow -- George Dodson.

The Super-Principal that retired this year after nine years at Smith Elementary (and 24 with the district), gave his endorsement and encouragement to Kulnis Monday, after she was named to the position by the school board.

"They really love him (Dodson) there -- while I could never fill his shoes, I hope I can gracefully tip-toe in them," she said.

Kulis has been with the district for 13 years in a number of capacities, including teaching and administrative spots.

She's put her expertise in early childhood development to work by

helping the district revise its kindergarten curriculum -- she should be even more of an asset to the district as a principal.

But how is Dodson going to spend all that free time he has?

Perhaps by running for a seat on the school board.

As of Monday, Dodson was officially "thinking about it."

"There needs to be some excitement up there," he said. "They need to talk to more people."

Congratulations to Claudia Kulnis, and Smith Elementary.

And thumbs up to Dodson for wanting to continue to invest his time and energy in the Plymouth-Canton schools, and in the community.

Regarding Barbara Graham's visit to the classroom -- come on! Since when don't parents, concerned citizens, taxpayers and school board members have every right to go into a classroom? What is there to fear? Or hide? Why was that incident so blown out of proportion?

Finally, in the few instances I have been in contact with Daskalakis, I have found her to be an honest, ethical, and caring person who has followed the procedures requested by the schools. In a quote from a March, 1989, letter from Dr. Michael Homes to Diane, he said "... I would hope that other would

represent themselves as directly and honestly as you do." This letter was in response to a complaint about the use of R-rated material in the schools. Judy Stone, principal of West Middle School, said she found Diane and the group of people who came to review library materials, respectful in their handling of the books and absolutely "no problem" to that school.

Please, open your minds and give us a more well-rounded and unbiased view of what is happening in the Plymouth-Canton area!

DIANE STAMP

Sorry about disgruntled letter

EDITOR:

OOPS!

Last week I wrote a disgruntled letter concerning North Territorial repairs.

I did not realize they were preparing it for resurfacing which is now being done.

Apologies to whoever is responsible for the resurfacing and to whom I asked was responsible for the "half-asphalt" job.

Now all I can say is "job well done." Our tax dollars are at work.

Thanks.

SPARKY KALLUNKI

Praise for Canton's Fest

EDITOR:

All too often people are very quick to criticize, and rarely pass on praise. I suppose that I have been guilty of that trait, also. People who know me, know that I have been critical of many issues both in and out of the Canton political arena. However, the time has come when I must balance the scale and give praise where it is due.

Canton recently staged the first annual "Canton Challenge Fest," which turned out to be modestly successful. The concept and execution of this event were well planned and carried out. My highest compliments go to Supervisor Yack, Bill Joyner, Mike Gouin and his staff, and to all

who made the effort to participate.

Hopefully next year's Fest will attract more participants and that planners will be able to schedule a wider variety of events. The only suggestion that I can offer for improvement would be to schedule more events with our senior citizens in mind.

Our senior population will be increasing greatly with the opening of the two new seniors housing centers, and I'm sure many of them would greatly appreciate efforts to include them in the Festival. If we had an "At-A-Boy" award it should surely go to Mr. Yack and all those who worked on this project.

RALPH H. SHUFELDT



Win Schrader on board his "swift boat" in the Mekong Delta area of South Vietnam.

For P-C soldiers Vietnam: a shared experience

BY KEN VOYLES

Tragedy does not enter into all stories about Vietnam. Most of those brave men and women who spent time "in country" returned and today are valued members of their communities.

Win Schrader, Rick DiVeto, Steve Mansfield and Mark Hyland were among the young Plymouth-Canton residents who served in Vietnam. Today they are highly respected citizens of this community.

Schrader is the third generation of his family to own and operate Schrader's Funeral Home on Main Street in Plymouth; DiVeto ran his

Glimpse At Yesterday

own business in the city for many years after the war; and today Mansfield and Hyland are partners at Heide's florist shop on Ann Arbor Trail.

Schrader, 45, spent two years with the U.S. Navy in Vietnam after graduating from Plymouth High School (1962) and the University of Michigan.

He enlisted after getting his degree to try and "determine my own fate," before being drafted.

As a lieutenant jg (junior grade), Schrader was stationed on the destroyer, USS Hopewell (DD-681), in the South China Sea off the coast of Vietnam. It was 1969 and the destroyer provided support for ground troops as well as harassment and interdiction fire.

During that stint Schrader's ship spent 40 days in the infamous Gulf of Tonkin off the coast of North Vietnam.

"It was very close quarters and confining," said Schrader of ship life. "Sometimes it was boring."

Schrader was eventually rotated out of Vietnam and retrained in heavily armed "Swift boats" which were being used along the riverways in Vietnam.

When he returned as a boat commander (with a crew of six) it was to a station along the Mekong River delta where he worked with Navy Seal teams on commando raids, as well as provided suppression fire and conducted boat searches.

"It was a little of everything," said Schrader, who took part in the first Cambodian invasion in 1970, taking his boat up the Mekong. "It was always clear that I was in command but I had to depend on my men considerably because if you were wounded the men had to get the boat back."

Schrader remembers blaring music (especially "I Can't Get No Satisfaction" by the Rolling Stones) at the enemy and wearing a .45 caliber pistol 24 hours a day, even sleeping with it. He said the boat's mascot was a monkey known as "Pig Pen Charlie."

Once Schrader even ventured into the river to try his hand at a little water

Please see pg. 31



It's time to dream, hope, plan— and seek the best prenatal care.

Pregnancy is a very special time of your life. An exciting time, filled with dreams and hopes for your baby. A busy time, spent picking out names and shopping for stuffed animals and wallpaper for the nursery. But during this joyful time, your most important obligation is receiving early, professional prenatal care.

We're here to help with the personal, individualized care you may want now more than ever before. On staff in our Women and Children's Health Care Center, you'll find physicians who specialize in obstetrics, perinatology, neonatology, genetics, and reproductive medicine who are dedicated to keeping up with the latest in prenatal medicine. Our physicians and nurses are devoted to their patients. When you choose one of our doctors, you'll have available all the resources of Oakwood Hospital, a 615-bed teaching facility where over 4,000 babies are delivered annually. Oakwood also offers ongoing classes with topics that include Child-birth Preparation, Positive Pregnancy Fitness, Parenting,

even Creative Grandparenting to keep the whole family involved.

How you care for yourself and your baby during pregnancy is just as important as what you do after your baby arrives. So think of this as the most important nine months of your baby's life. And, whether you're already pregnant or just considering the possibility, take the time now to call 1-800-543-WELL for a physician on the staff of Oakwood Hospital.

Consider it time well spent.

Oakwood Hospital



Here to help.

18101 Oakwood Blvd., Dearborn

The Community Crier

USPS-340-150 Published weekly at 821 Penniman Ave., Plymouth, MI 48170. Carrier delivered: \$20 per year. Mail delivered: \$30 per year. Mailed 2nd class circulation rates, postage paid at Plymouth, MI 48170. Call (313) 453-6900 for delivery.



The Crier's advertisers strive to honestly present commercial messages to our readers. If, for any reason, you find problems with a Crier ad, please call our office at 453-6900.

Crier advertising is published in accordance with those policies spelled out on the current rate card, which is available during business hours from our office at 821 Penniman Ave., Plymouth. The publisher solely makes final acceptance of a specific advertisement (not an advertising representative) and only publication of the ad signifies such acceptance.

Postmaster, send change of address notice to: The Community Crier, 821 Penniman Ave., Plymouth, MI 48170.

Through the lives of P-C soldiers

Telling the 'Nam, Korea story

Eckles

BY KEN VOYLES

By 1969 the 1st Cavalry (Airmobile) Division was the kind of U.S. Army unit destined to carry out the toughest assignments.

Treading the steamy jungles and rice paddies of Vietnam while chasing an elusive foe on search and destroy missions, the soldiers of the Air Cav became a tough, gritty lot.

A 1966 graduate of Plymouth High School, Private First Class James Patrick Eckles, had been fighting with the Company C, 1st Battalion 12th Cavalry, 1st Cavalry Division since early 1969.

In a letter home to Plymouth, Eckles describes the "work" for his mother, Sally Eckles:

"Boy did we hit it big two days ago (right after we came off of our company R & R). We had to check out a big bunker complex that Company A found. And in the process we found three big (caches). That's where the gooks dig a big hole and bury all their stuff for storage. We found about 2 tons of ammo, ranging from rifle bullets to rounds for their big guns. Also approximately 35,000 lbs. of rice. And all this looks good for our company records."

As a postscript later, he adds: *"P.S....have been put in for Spec. 4, that's another \$60 a month."*

The letter is dated Aug. 9, 1969, just three days before Eckles was killed north of Saigon, near a place called Bien Hoa. This year marks the 20th anniversary of his death.

Eckles' company Captain Scott A. Graves said the 20-year-old Plymouth soldier was participating in a search and clear mission on the morning of the 12th when he was mortally

Plymouth-Canton HEROES



JAMES PATRICK ECKLES

wounded by enemy forces in a "firefight."

Graves said, "death came quickly to Eckles....James was an exemplary soldier and died while serving his country...He was a valuable member of this unit and his loss came as a shock to all who knew him. I am proud to have served with him."

Eckles' death also came as a heavy blow to his family and friends at home in Plymouth.

Upon his death Eckles was awarded the Bronze Star medal, the Purple Heart and a Good Conduct medal. He had already been awarded several combat badges, including one as a sharpshooter.

Three weeks before his death Eckles wrote: *"...just sitting in the middle of nowhere and thought that I'd better get a few lines out to you. Hope it doesn't start raining before I finish. As it is I'll have to finish tonight when we get set up"*

"Don't know what it will be like when I get home to walk around without a gun in my hand all the time. Right now I carry a machine gun on my shoulder and a .45 cal. pistol on my hip. Also two - three hundred rounds of ammo slung over my shoulder. And man I mean to tell ya, I can really get hung up on these vines over here."

Three days before he discovered that his identical twin brother had been killed, Walter Michael Eckles said he felt that something had happened.

"I couldn't sleep at night. I was extremely agitated and irritable," he said. "I stayed home from work the day they came. I didn't know why at the time."

Sally Eckles also had a feeling that her son had been killed shortly before the terrible news arrived in Plymouth.

"I just knew something was very wrong," said Sally.

While Pat was in South Vietnam his family kept in close touch, sending letters and care packages, which usually included lots of Koolaid and popcorn (the popcorn was used as a packing material). Eckles was a consistent writer, keeping in contact with his parents, his brother Mike, his sister Karry, his grandparents, and, of course, his young wife Denise Eckles, who was pregnant with Eckles' baby, Candi.

Mike also said he sent his brother Jack Daniels in a Listerine bottle several times. "He wondered at first why the hell I sent him Listerine," said Eckles.

Larry and Sally Eckles found out they were going to have twins on Halloween of 1948. It was to be their family doctor's first set of twins and the Eckles' first children.

Sally Eckles remembers keeping her doctor from going deer hunting. "They were in a hurry to get out," she said.

James Patrick Eckles was born on Nov. 16, 1948 at Mt. Carmel Hospital in Detroit, eight minutes ahead of his identical twin brother Walter Michael Eckles. With their birth the Eckles family name reached back four generations.

"They use to amaze me," Sally Eckles said. "What one didn't think of the other one did. They seemed to know what each other was thinking."

A sister, Karry, was born three years later. She remembers her brothers carrying on conversations with each other while they slept.

"Twins have a closeness that you just can't dismiss," said Karry (Langeaster). "It's a special closeness."

Mike Eckles said having a twin

Sarah



HUGH SARAH

BY KEN VOYLES

Hugh Henry Sarah -- "Butch" to everyone that knew him -- affected a lot of people.

A star athlete in high school, a brilliant young biologist in college, the Canton resident was the oldest soldier from Plymouth-Canton to die in South Vietnam. He was 24 and a private first class with Company D, 2nd Battalion (Airmobile), 8th Cavalry (U.S. Army) when badly wounded in action on September 14, 1969.

Sarah died of those wounds nine days later -- just three days before another Plymouth-Canton soldier, Dick Larrick, was killed in Vietnam.

This year is the 20th anniversary of his death in the Vietnam conflict. Butch is among the local heroes who will be honored with a memorial monument on July 4 in Kellogg Park.

"I loved the guy from day one," said Wayne Cummins, a high school friend of Sarah's. "Everybody loved him and the people that knew him have never forgotten him. I've broken down every year since his death. It just comes over me. I can't believe he's not around."

"He was brilliant, deeply philosophical," Cummins added. "He was a tough kid, a mentor of mine, but he had a heart of gold."

"Our relationship was very special," said Sarah's wife at the time of his death, Vickie Wilson, now 44, of Washington D.C. "There was just that spark between us. We had our first kisses together -- our first everything together."

"He was a good son. We never had any trouble with him," said Butch's mother May Sarah, 69, who now lives



Mike Eckles, Sally Eckles and Karry Langeaster (left to right) remember Pat Eckles as an easy going youth who loved cars. (Crier photo by Chris Farina)

In Vietnam, Korea

Saluting those who were killed

Continued from pg. 1

Seven of those Plymouth-Canton soldiers were killed in action, including Hugh Henry (Butch) Sarah, James Patrick Eckles, Richard Loren Nowry, Richard Allen Larrick, Harry Franklin (Butch) Zalesny, Jr., James Thomas Fields and Harry E. Baker, Jr.

This year marks the 20-year anniversary of the deaths of four Plymouth-Canton soldiers -- Eckles, Sarah, Zalesny and Fields -- all of whom were killed in action in 1969 or died from their combat wounds.

Those four young men, along with the others who were killed from Plymouth-Canton, will be honored during the upcoming July 4th holiday with a memorial monument that is being erected in the City of Plymouth's Kellogg Park.

Also being honored is Morris Beasley, a 17-year-old Plymouth youth who went off to fight in the Korean conflict and who never returned home. Beasley, the only Plymouth-Canton soldier killed in Korea, was reported missing in action after his convoy was attacked in 1950. His body was never found.

This is the story of those



Glimpse At Yesterday

men who gave their lives for their country in two very different conflicts during two very different eras. It is a story of valor and courage, as well as frustration, bitterness, and ultimately, sadness.

Though they had varying pasts, all eight of the men who will be honored shared one thing -- they were young, bright and ready to experience the world. Seven of them also shared a war in Vietnam that wasn't really considered a war.

Beasley, 16 when he went into the military, was 17 when he was reported missing in action.

Butch Zalesny, who got a pilot's license before his driver's license, was 18 when he enlisted and 19 when he died; Eckles, Fields and Baker were all 20 when they died (Fields was killed less than three months before his 21st birthday); Larrick and Nowry were both 21 when they died; and Butch Sarah, the elder statesman of the group, turned

24 a month before he succumbed from wounds suffered in a firefight.

Eckles and Sarah, among the most popular students in their classes at Plymouth High School, were both fathers to be when they died, but neither ever knew their children -- Candi Eckles and Hugh Kent Sarah.

Four days before he was killed Eckles sent his identical twin brother Walter Michael, Eckles a letter. In it he wrote,

"There are guys here taking pictures for the papers and I got a few taken of me (hot stuff!). Make sure everybody at home gets to see the pictures...Have put in for Spec 4. Hope to get it next month. It's \$60 more a month."

In a letter to his parents dated Sept. 10, 1969 (two days before he was wounded and two weeks before he died) Sarah wrote, *"I am constantly afraid of an ambush. It makes me very*

nervous. I guess it is natural. All of the guys walking behind you are depending on you -- if you mess up, a lot of your buddies are gone.

"Well, I don't want to be morbid. I've got to go because night is setting in. Miss you both..."

Larrick, trying to find a perspective on the war, wrote to his mother, *"I do not want to kill, but I have to kill not to be killed."*

Through their words, photographs and the recollections of family and friends, the deeds of Plymouth-Canton's heroes remain ingrained in our society and our community.

Many people would like to forget the wars, especially the conflict in Vietnam, but forgetting remains impossible for those family and friends who suffered a loss, and who, to this day, live with a sting of pain that just will not go away.

This is a salute to those soldiers -- a celebration of their tragically shortened lives, but it is not a celebration of war, that forever inhuman institution which rips apart families and destroys lives.

Korea, Vietnam 'unofficial' wars

BY KEN VOYLES

In the post-World War II age, two conflicts have pulled and tugged at the hearts and minds of Americans -- the Korean and Vietnam conflicts.

Both have always been known to this day as "conflicts" and not wars. The

U.S. never declared war during either, but the Korean struggle became known as only a "police action."

As wars go the two are very different from each other, as different as the age in which they were fought -- Korea, a more traditional fight in the afterglow of U.S. success during World War II, and Vietnam, during the peak and then slow downward turn of this country's world dominating superpowerdom.

While the struggle in Korea ended in a stalemate after three long years of fighting, Vietnam stretched on and on, over the course of more than a decade. The U.S.'s involvement cannot be pegged down to a specific date, but it began in the 1950s following the disastrous attempt by the French to hold on to their colonial showpiece and reached a peak for America by 1969 -- 20 years ago today.

"In Korea we had a lot of support. There was never a feeling of this giant country, the U.S. against a tiny nation. So we didn't look like the bad guys," said Wayne Cummins, a U.S. history teacher at Westland John Glenn High School and a good friend of Hugh 'Butch' Sarah, a young Canton man who died in Vietnam.

As for Vietnam, Cummins said, "it was just an American effort. To the whole world it looked like we were picking on the Vietnamese. The French warned us not to get involved."

The "forgotten war" in Korea began in June of 1950 when North Korean troops attacked southward into South Korea. The U.S. was able to garner support from the United Nations (thanks to a mysterious Soviet absence) and a multi-nation force went into action to stop the onslaught.

Led by General Douglas MacArthur, the UN forces were eventually able to turn the tables in the war after the disastrous start, which almost saw the North Koreans push the U.S. completely out of the country.

After MacArthur landed an Inchon late in 1950 the UN forces pushed the North Koreans back to the Yalu River where nervous Chinese forces suddenly intervened and attacked, sending UN forces reeling through another headlong retreat.

Eventually the front stabilized and a war of attrition set in with each side fighting to gain an advantage around the 38th parallel.

"Yes, we had our ups and downs in

Korea, but it really didn't last long enough for support at home to wither away," Cummins said. "I do believe the war would have lost support if it had lasted much longer. We were used to short wars up to then."

Please see pg. 12

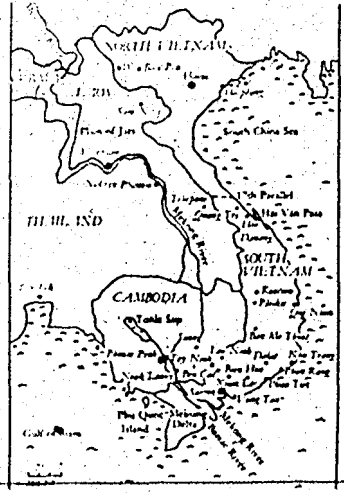

Southeast Asia includes Vietnam, Laos and Cambodia.

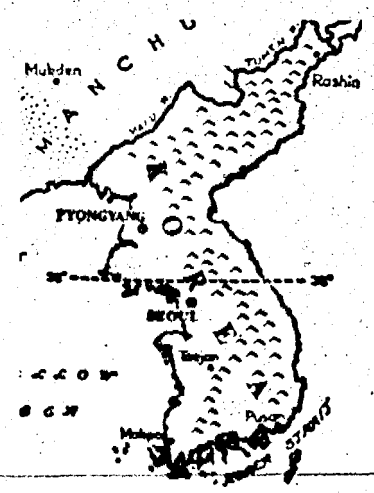

The Korean peninsula is divided, to this day, at the 38th parallel.

Fighting at Khe Sanh, 'in country'

PG. 9 THE COMMUNITY CRIER: Jan 23, 1969

Nowry

BY KEN VOYLES

To this day, Khe Sanh, Hue and the Tet Offensive (1968) remain among the most unforgettable names from the U.S.'s tragic involvement in the Vietnam struggle.

Richard Loren Nowry, a young Plymouth resident, took part in all three, but was killed on May 9, 1968, outside of Khe Sanh, just five weeks before his tour of duty was to have ended.

Nowry, who was 21 when he died, was a lance corporal in the U.S. Marines during that terrible year. He had enlisted in the service in 1966 and had already completed one tour "in country."

The son of Ken and Mary Nowry was born on Jan. 25, 1947. His father had served in World War II with the famous "Big Red One" (First Division), landing at Omaha beach after campaigns in Africa, Sicily, and Italy. Ken Nowry was wounded three times during the war and was captured by the Germans at the Battle of the Bulge.

The oldest of four sons, Richard was the only one to follow his father's path by joining the military.

Enrolled in the Wayne-Westland School District (the family had both a Plymouth phone number and mailing address, and Ken Nowry was raised in Plymouth), Richard graduated from Livonia Franklin High.

As a youth Nowry loved animals, sports, playing clarinet in his school band, collecting stamps and coins, and bowling.

"He was an all around American boy," said his mom Mary Nowry, "He was always doing something for somebody. He was an outgoing young man with a lot of girl friends."

As a teenager Richard Nowry saved his money from mowing lawns and put it in some stock. When the stock went up he sold it and bought a motorcycle. In some of his letters home from

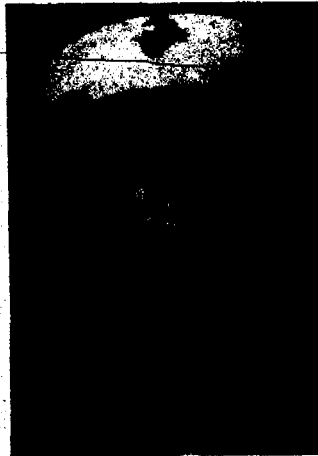

RICHARD NOWRY

Vietnam, Nowry repeatedly quizzed his parents about the current prices of motorcycles in the States.

While in high school Nowry told his mother that he had a "gut feeling that he'd go over there and not come back."

When Nowry received his draft notice he decided to join the Marines before being called up. He had a chance to train as an officer but decided against it. During his first tour, Nowry spent 13 months in Vietnam, returning home around Christmas of 1967.

"He gave me a hug when he came home and said, 'I didn't come home with a Purple Heart,' almost as if he was ashamed," said Mary Nowry. "I told him I liked the heart that was still beating in his chest."

Nowry returned to the service after his leave period, but told his parents that he was going to be stationed in California. Instead, Nowry went back to Vietnam. When he finally told his parents the truth, Nowry's mother said her son said he was "concerned about the children in Vietnam."

"He said the children, the people there needed him," said Nowry.

When the Tet offensive began in 1968 Nowry saw action in the street fighting which swirled around Hue.

In a letter dated Feb. 20, 1968 Nowry told his parents of the fighting: "The VC (Vietcong) still hold parts of the city and we're trying to push them out still. The fighting has been going on since the 29th of January..."

"...Boy I wish I could have a hot shower and shave and a hot meal. I haven't showered in a week and a half and I've been working long hours helping to load bodies in my truck...Sometimes I wonder if its worth it all. Anyway, I'm healthy in spite of it all. No diarrhea yet, thank heavens."

He added: "I don't really know how much the bikes are selling for now, but I figured somewhere in the vicinity of \$375....I could pay cash for my new bike and still have better than \$500 left."

In another letter Nowry describes how it was suggested that he attend the U.S. Naval Academy at Annapolis (MD). He writes: "I've gotta run now."

Nowry 'in country' near Khe Sanh.

Please see pg. 35

Zalesny

BY KEN VOYLES

Awarded more than 50 medals, Harry Franklin Zalesny, Jr., was the most decorated soldier from Plymouth-Canton to die in Vietnam.

A pilot at 15, Zalesny commanded "Playboy 18," his Cobra helicopter gunship in 'Nam. When he was killed Zalesny, a Canton resident, had clocked nearly 30 missions over enemy territory. He died two months before his 21st birthday.

"Butch was interested in flying at a very early age," remembers his brother Donald Zalesny, a Canton resident who works for Northwest Airlines as a mechanic. "He spent all of his free time at the airport. He got a job there after they took him under their wing."

The oldest of two sons, Zalesny was born Feb. 20, 1949. He was killed three days before Christmas of 1969.

The Zalesny family moved to Canton in 1957 and both sons graduated from Plymouth High School - Butch in 1967 and Don in 1968.

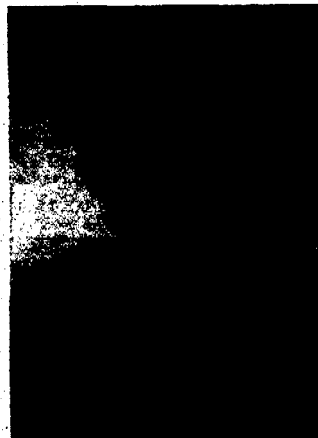

HARRY ZALESNY

As a youth, the older Zalesny spent most of his time at an airport on Ford Road near Lotz Road where he'd watch planes take off and land. He soon became a regular sight at the airport where he was befriended by Johnny Parker, who, with the permission of Margaret and Harry Zalesny, would take Butch flying.

Flying became everything for Butch. He would fly his family and friends all over Michigan and Ohio. "Flying was his bag," said his brother. "I just want to remember him the way he was - alive and well and happy, especially when he was flying."

Don Zalesny especially remembers one story when his brother "buzzed" the airport on Ford Road in an old biplane, coming in at less than 10 feet off the ground.

Shortly after graduating, Zalesny, who was an above average student in high school, enlisted in the U.S. Army. "He was very patriotic and he wanted to fly," said his brother. Completing

aviation school in January, 1969, Zalesny was assigned to the 334th Aviation Company in Vietnam as Chief Warrant Officer in command of a helicopter.

Proving himself a capable pilot at a young age, Zalesny also showed promise as a soldier. In one incident in October, 1969, Zalesny's ship "reacted magnificently to an enemy sighting and has been credited with 10 kills," according to a report from another unit, the 17th Cavalry Division.

"Another unit had the same high regard for Zalesny and his "Playboy" crew. Called in to help the men of Company M of the 75th Infantry, Zalesny's airship "was the first on the scene and received a heavy amount of ground fire. The gunship stayed there for two hours, keeping us covered and forming a buffer zone between us and the enemy," said Sgt. Joe Acosta, who led the ground forces.

While "in country" Zalesny sent his family cassette tapes twice a month, and even talked to them over a Ham radio net set up for servicemen.

"He'd tell us not to worry that everything was cool," said Don Zalesny.

On Dec. 22, 1969, Zalesny was leading a team of two Cobras in support of a group unit at the village of Bu Dop. When an enemy gun position was located, Zalesny led his team into an attack.

About a half mile from the target, flying in low-level, Zalesny's aircraft was hit by .50 caliber fire and crashed into the trees at a fairly high speed. Ground units rushed to help the pilots. When they arrived Zalesny and his co-pilot were dead. The ground forces were able to recover the co-pilot's body but the helicopter blew up before they could get Zalesny's body out. His body wasn't recovered until after the fire burned out.

"Your son was an excellent pilot and a tremendous asset to the 334th Aviation," said Charles Densford, a major. "We shall miss him not only for his flying skill, but for his many contributions to the company."

In another letter to the family, men of the Playboy said they would try to "accept the fact that only the good deserve the right to die young."

Please see pg. 35

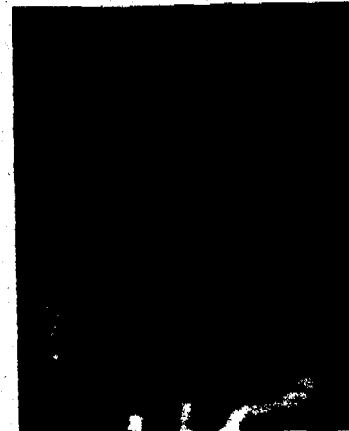

Zalesny (top right in photo) with some of his crew of "Playboy 18."

From Quang Tri to the 38th parallel

Larrick

BY KEN VOYLES

"I had a dream. I could just see the officer coming to the door."

That's how Irma Larrick knew in September of 1968 that her 21-year-old son Richard Larrick had been killed while fighting in Vietnam.

"I wasn't surprised," she said recently. "I think that it was just a mother's instinct...My husband and son Dale were so affected by it."

Richard Allen Larrick was born in Ann Arbor on May 5, 1947 just before his family moved to Canton. He was a well loved boy, the type that would help someone who needed something done, or help out his father Delbert along the family's rubbish collection route in Plymouth.

As he grew Larrick became interested more in making money than school, said his mother. He especially loved to cook (Spanish Rice was a specialty). He worked at Bode's on Plymouth's Main Street for a while and planned to someday open his own restaurant.

"He was fun and light hearted. Everybody liked him," said Larrick's sister, Bonnie Hammond, of Westland.

"Dick was also quite the artist," said Irma.

Larrick was born third in a family of five children. His oldest brother Dale still lives in Canton and Irma and Delbert reside in Florida.

All of the children attended Plymouth High School. But Dick left high school before finishing, forsaking education for a world of work and money.

A high school advisor wrote to the Larricks after their son's death: "Although Dick never was fully interested in some school subjects, all his teachers always spoke highly of him as a likeable and hard working young man."

One thing Dick Larrick, and his brother Dale, enjoyed was tooling around on motorcycles, occasionally getting in trouble with the Plymouth police. (Years later a Dearborn Police motorcycle unit led Larrick's funeral procession through Plymouth; he is buried at Riverside Cemetery.)

Larrick was drafted in 1967, though Irma said Dick had a stomach ailment since he was a very young child and probably should not have been selected.

"Why they took him in the service I'll never know," Larrick's mother said. "But I'm never one to blame. I just look at the bright side of things. I remember the fun things."

Larrick spent his time in Vietnam with an Aero Scout Company, of the 123d Aviation Battalion, Americal Division, U.S. Army.

The last time Irma Larrick saw her son -- the winner of a Bronze Star, like many of his comrades from Plymouth-



RICHARD LARRICK

Canton -- was in June of 1968 when she made a surprise visit to Hawaii. She said her son was bothered about having to kill people.

Nearing the end of his tour (literally weeks) Larrick was killed on Sept. 26, 1968 while on patrol in South Vietnam. His unit was participating in a combat assault near Tam Ky City in Quang Tri Province. It was just about noon as the patrol moved through a "village complex" when Larrick was mortally wounded by enemy fire.

Bonnie Hammond, who remembers a calendar at the family home with each day's passing marked off waiting for Dick's return, said her brother's death was "just like a nightmare."

Bill Bezanson, a close friend of Larrick's later wrote Irma:

"When (Dick) was killed I was deeply hurt yet proud of him. He died the most honorable way any man can. Whenever I think of him my chest will swell with pride cause I can say of this man, 'He was my buddy...I would have taken his place if I could have. I loved him that much.'"

In a letter dated four days after Larrick's death, Bezanson wrote to his parents, telling them about some of his friends. Four of them were known as "the Exterminators." Dick Larrick was "Learch" among the group.

"Learch was my home-boy, my main-man," he told his parents. "The four of us were more like brothers...We've fought in and started some of the major battles in the lower I Corp area. We've been through hell together...losing Learch was as though a piece of me was left lying there."

A closed casket funeral ceremony was held for Larrick at Schrader's Funeral Home in Plymouth, but not before Larrick's cousin James Lee insisted on seeing Dick to find a birth mark on his relative's back.

"He wanted to make sure I guess," said Hammond, who added that with the passing of years the painful memories have faded a little. "Things around you don't remind you so much about them anymore."

"Just to be angry, I'm not that type," said Irma Larrick. "I like happiness even if you can't always have it."

Beasley

BY KEN VOYLES

There has never been a funeral service for Morris F. Beasley. No grave stone marks his resting place -- he was never given a proper burial.

That's because the 17-year-old Plymouth resident was reported missing in action (MIA) in 1950 when his supply convoy was attacked by North Koreans during the early fighting in the Korean conflict.

Seven years later Beasley was finally declared dead by the U.S. military, but no trace of his remains were ever found. To this day search teams still comb South Korea looking for the remains of missing Americans, including Beasley.

"We didn't want to have a 'mock' funeral or give up hope," said Beasley's younger brother Marion Beasley, 64, and a resident of South Lyon. "That's also why this is good -- there's nothing for the Korean guys."

Today Morris Beasley's name can be found on a monument in the City of Bardwell, a county seat in Kentucky, near where he was born. It was put up about a year ago.

Beasley will also be among those soldiers honored this July 4th when a monument is dedicated in Plymouth's Kellogg Park. He is, in fact, the only soldier from Plymouth-Canton to die in Korea.

Marion Beasley described his brother as a typical older brother type. When the pair were real young, they did a lot of things together like going to movies or the park.

"He was my protector I guess," said Marion Beasley. "He was my big brother, but by the time he went in he had his own group of friends and I had mine, so we didn't see much of each other."

Beasley entered the service at age 16, according to his brother, because he was having trouble finding a steady job. He had dropped out of Plymouth High School after sophomore year (in

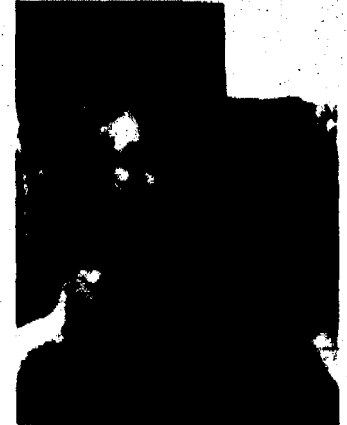

Beasley's brother Marion Beasley holds a photograph -- the only one -- of his late brother.



MORRIS BEASLEY

1949) so that he could join the U.S. Army.

"He didn't even have a driver's license when he enlisted," said Marion. "At the time it was kind of exciting. Neither of us had any idea we'd (America) be in a war."

J.C. and Burla A. Beasley were concerned by their son's desire to enter the military but they reluctantly agreed to sign the waiver forms.

The Beasleys had moved to Plymouth with their two sons from their original home in Kentucky. It was an economical move, according to Marion Beasley. The family lived in the city for awhile and later on in Plymouth Township.

When Beasley joined the service he had no idea he would be shortly fighting a war in Korea, but when the North Koreans invaded in early 1950 he was among those U.S. troops shipped to the battle zone.

A private in the Headquarters Service Company, 6th Medium Tank Battalion, Eighth U.S. Army, Beasley had become skilled at driving a supply truck in support of his unit's tank outfit.

During the hours of darkness on Sept. 4, 1950, Beasley was driving a truck in a convoy moving infantry troops to the north. About two miles north of Kyonju, Korea, the column of trucks was stopped by an enemy road block and came under heavy machine guns and grenade fire.

Most of the trucks in the convoy were hit and caught on fire.

"In the confusion of the attack no one ever actually saw what happened to Morris," according to a letter from Lt. Col. Ernest Zeisler, who added that "(Morris) did not rejoin the convoy after the enemy dispersed."

The Beasleys were told in a telegram advising them that their son had been missing in action since Sept. 4. At about the same time, two letters from their son arrived in Plymouth (they were dated Sept. 10).

In the letters, he wrote of the continual danger his outfit faced from the North Koreans, who had a knack

Sarah, all-star athlete and scholar

Continued from pg. 7

in Dexter. "He was a good student too, when he made up his mind about it. I'd call him a normal boy."

Rick DiVeto, of Plymouth, knew Sarah in high school.

"Sarah was pretty much an outgoing guy with a real nice personality," DiVeto said. "He got along with everybody. He wasn't the type that it was hard to get along with."

Hugh 'Butch' Sarah was born on Aug. 5, 1945 to Hugh and May Sarah, of Detroit. He was the youngest of three children. When he was just two years old the family moved to Canton.

An ordinary child, according to his mother, who besides teasing his two sisters, took an early interest in athletics.

In junior high, Sarah met Wayne Cummins and Vickie McCuaig, who was to become his wife. His grades slipped a little in junior high but by high school he had become a solid student, graduating at the top of his class at Plymouth High School (1963).

"Butch was like a renaissance man," Vickie said. "He was a poet, an intellectual. He loved operas and paintings. He was just very unusual. He had incredible insights into life."

While in high school Sarah played football and joined the track team. Sarah's shot put record, set in his senior year at 66 feet, two inches, remains good to this day. He also finished second in the state in shot put one year.

"Butch always use to practice in the backyard using a piece of iron ore," his mother remembers. "He was a big, strong boy. (Butch stood at 5-10 and weighed at his peak more than 200 pounds.)"

"I was an athlete in school, but this guy was really an athlete," said Cummins. "He didn't even know how to throw the shot correctly until someone showed him at the state meet one year."

Cummins also remembers when Sarah won a weight lifting meet in 10th grade, being told at the time that "he had a gift" by an Olympic thrower.

"He was a Butch," said May Sarah, who added that her son protected the underdogs in school, especially a young retarded boy. "He got into more fights over him."

"He was rough and ready like his father, who was also called Butch," she added. "He was a real scrapper, but he never looked for trouble."

Cummins said, "He was just that kind of guy, he was a very, very moral person."

During the summers, Sarah worked at the Cummins family factory.

Sarah and McCuaig were known as the all-American couple at Plymouth High - Butch was the phenomenal athlete and Vickie was homecoming queen one year.

"Butch could have done a lot of things," said Vickie. "Like a lot of boys at that age he became enchanted with his athletic prowess."

That athletic ability led to a football scholarship to play at the University of Wyoming. Feeling lonely out west Sarah returned home in 1968.



Vickie and Butch.

While attending Eastern Michigan University, Sarah had two papers published in science journals; his main interest was studying biology.

That transformation from a high school jock to a serious college student still amazes Vickie. "He had a macho image but he was much deeper," she said. "It was quite a transformation from athletics to academics."

On July 6, 1966, Butch Sarah and Vickie McCuaig married. Wayne Cummins was best man at the ceremony. Then in 1968 Sarah and Cummins both graduated from college.

"I asked him to be my best man but he was going into the service by then and he had just one more chance to see his wife," remembers Cummins.

Sarah beat the draft board by enlisting in the U.S. Army in 1967. He reached Vietnam in early 1969.

"It wasn't because of patriotism," said Vickie. "He did it because he knew all of our class was being called up. He wasn't one to walk away from it." When he enlisted Sarah hoped to determine his own fate, maybe even wind up studying biology for the Army.

"You have to do what you have to do," said his mother. "That's the way I raised the kids. I've always been very patriotic, although I'm sick of war." (May Sarah lost a brother fighting in World War II.)

Sarah passed up a chance to com-

plete officer's training school, said his mother, because he wanted to "get over there and get it over with."

"Well he did," she said.

"He was very patriotic," said Cummins. "He told me he wanted to get this behind him and go on with his life. He could have been just a great contributor to this country."

"I learned so much from him. If I hadn't meet him I'd be a different person."

As Sarah tramped the jungles of South Vietnam, learning the realities of war with the foot soldiers of the 8th Cavalry (of the famous 1st Cavalry unit), back in Plymouth his wife Vickie was moving quickly forward through her first pregnancy.

Sarah kept in touch with Vickie, writing her constantly. He also wrote his parents a steady stream of letters.

From those letters one grasps what it was like in Vietnam for one of Plymouth-Canton's native sons.

On July 12, 1969 Sarah wrote: "I don't have much of an appetite - I think it might be the heat. Maybe its nervous stomach."



May Sarah shows off some of her late son's medals.

A week later he describes going into "the field" for operations in Tay Ninh Province. Sarah wrote: "I'm a little worried but I guess that's natural. Once I make contact I'll probably lose some of these butterflies. This unit sees a fair amount of action. I don't want you to worry but I also want you to know what I'm doing...I don't care for the bugs and the rain. Nice place to visit but I wouldn't want to live here - wow!"



Besides military medals, Sarah also won numerous track awards (seen at left in the photo).

In a letter dated Aug. 18, 1969 Sarah described the affects of fighting in the jungles of Vietnam. "I'm tired. Being out here just kicks your rear end. It is bad on your nerves and I think that is what makes me tired."

Another week passed and Sarah wrote: "We've been 16 days in the boonies now. I don't know when we'll go back in but I sure would like a can of cold beer. Haven't seen many gooks but they have ways of making their presence known."

"Take good care of my family - Vickie needs friends now. I know the baby will be taken care of...try slipping a couple of cans of beer in those packages when you send them."

On Sept. 3, 1969 (nine days before he was wounded) Sarah wrote: "Still out in the field with no sign of going in for a while."

Then on Sept. 12 while Comany D moved toward an enemy bunker complex in Tay Ninh Province they came under fire.

Sarah, who had already taken part in more than 25 missions, was part of the "point element" which was soon pinned down and unable to move. Sarah decided to move (under fire) to a spot where he could help provide suppression fire. He engaged the enemy "with complete disregard for his personal safety" but as the enemy withdrew, it laid down a heavy volume of fire.

During the barrage Sarah was fatally wounded. He died nine days later on Sept. 23, 1969 (the date of his parents wedding anniversary) of a lung embolism, having also suffered a broken eardrum and the loss of an arm (he also took shrapnel in the stomach).

"Due to (Sarah's) heroic efforts, Company D was able to inflict a decisive defeat to the attacking enemy," wrote his Colonel Joseph Kingston. "His display of personal bravery and devotion to duty were in keeping with the highest traditions of the military..."

Sarah was posthumously awarded a Bronze Star medal, and two Purple Hearts.

Shortly before his death Sarah wrote: "We have been out here for 28 or 29 days now and we are looking forward to a 3 day R & R in Tay Ninh. We'll probably still be looking forward to it a month from now."

Back at home in Plymouth Vickie was nearly ready to give birth to Sarah's son - Hugh Kent - when she heard the news of her husband's wounds. Vickie asked her doctors to induce labor but they refused.

When the news arrived of Butch's death Vicki then went back into the hospital to give birth. Sarah's funeral at Schrader's Funeral Home in Plymouth was delayed shortly until after the child was born.

May Sarah said she remembers being at work and rushing home when the official news arrived.

"The grief was just terrible," remembers Cummins. "You don't think about losing friends when you're that young."

Sarah was buried in Novi with full military honors.

The wars: as different as their eras

Continued from pg. 8

Cummins said the fighting in Korea was similar to that of World War II because the soldiers knew who the enemy was. That was never the case completely in Vietnam.

MacArthur, who was fired by President Harry Truman in 1951, in the middle of the conflict, viewed the war as a way to stop the spread of Communism in Asia.

"He wanted to win at any cost," said Cummins. MacArthur was prepared to invade China and even use atomic weapons in his quest to defeat the Chinese and North Koreans.

"He was a big hero at home," said Cummins. "And yes, he saved our butt at the beginning of the conflict."

By the time the war ended it had become a bloody stalemate and neither side was in a position to defeat the other. When Dwight D. Eisenhower became president in 1953 he began the process of stopping the war and getting the U.S. out of the conflict.

The police action ended on July 27, 1954, with battle lines still drawn (and they remain that way today). By the end more than 33,000 American soldiers were killed and another 100,000 wounded. More than five million men and women had served during the war.

Marion Beasley, brother of Morris Beasley, a 17-year-old Plymouth youth who was reported missing in action in Korea but never found, said, "World War II was a patriotic war, but not these others (Korea and Vietnam).

"Korea was different," he added. "We didn't see the vivid pictures like



Wayne Cummins, a U.S. history teacher, points out Southeast Asia. (Crier photo by Chris Farina)

from Vietnam."

American involvement in Vietnam dates to World War II when U.S. forces helped guerrillas fighting the Japanese there. When the war ended the French returned to reclaim their colony only to be met by fierce resistance from many of those same Vietnamese.

At the infamous siege of Dien-bienphu in 1954 French forces were finally humiliated and crushed by Communist troops under General Giap.

That same year Vietnam was split in two, forming North and South Vietnam. Within another year the U.S. was funneling aid to South Vietnam. That aid steadily increased under Eisenhower and then John F. Kennedy. By 1963, there were 15,000 U.S.

military advisors in Vietnam, some of them actively taking part in combat.

Lyndon Johnson began the massive U.S. military build-up in 1964 following the Tonkin Gulf incident when North Vietnamese gunboats fired on a U.S. ship. A Congressional resolution gave Johnson "extraordinary power" to act in Southeast Asia.

Cummins said he believes Kennedy may have "seen the light" about Vietnam shortly before he was assassinated, but Johnson never did see light at the end of the tunnel. Instead the new president brooded over mounting U.S. casualties. By 1965, there were 200,000 U.S. combat troops "in country."

Then, according to Cummins, it became a question of when to cut "our losses" and leave. Feeling against the

war steadily mounted with every increase in casualty figures.

Cummins remembers visiting Europe in 1966 and being questioned by French, English, Belgians and other Europeans about the U.S. commitment in Vietnam. "They said we shouldn't get involved," he said.

That same year was pivotal for Cummins as well. By then he had begun to have serious doubts philosophically about the war. He had favored committing to Vietnam in the beginning but as the war dragged the likelihood of a quick victory faded and a new mindset took over — a mindset that entailed just outlasting the enemy, like a boxer in a standup fight where neither side has a definite advantage.

"This was our first major guerrilla war and we didn't know how to handle it," Cummins said. "We kept believing that just a few more victories would make us the winners. We were already so committed by 1967 it was hard to back out.

"By 1968 we had thrown stuff at them over and over and still we couldn't beat them," he continued.

Cummins said negative reaction to the war began by 1965 and took off following the 1968 Tet offensive by North Vietnam.

"From then on all the support went downhill," Cummins said.

Vietnam was a different experience for U.S. combat troops. You never knew who the enemy was or where they'd turn up. Soldiers could be killed anywhere, not just at some "front line."

And the idea of bringing democracy to a place that had never experienced it soon lost its attraction. "What were we fighting for?" Cummins said. "I don't think we wanted to kill for nothing."

Under President Richard Nixon, America began a long and painful withdrawal from Vietnam (after adding to our difficulties with incursions in Cambodia and Laos).

By March of 1973 the last American troops had left Vietnam; South Vietnam fell to the north two years later. Saigon was captured on April 30 of that year.

Cummins, who graduated from Plymouth High School and has degrees from Taylor University (IN) and Eastern Michigan, began teaching in 1968, the year of Tet, and has done so ever since. U.S. history after 1945 is his specialty.

To this day Cummins, who still lives in Plymouth, said he tells his students about his friend Butch Sarah and tries to give the students a perspective on the war using Butch's experiences.

"My students know who Butch is," he said. "Since our schools are in the same league with Salem (High) I tell them to check out the track record board over there when they go to games.

"Butch's name is still up there for the shot put."

It is a record that has stood the test of time — now it is as much a part of history as the war in which Sarah fought.

P-C's other soldier heroes

Fields

BY KEN VOYLES

Two other Plymouth residents were killed fighting in Vietnam — James Thomas Fields and Harry E. Baker, jr. They will both be honored during the Tuesday dedication of a memorial in Kellogg Park.

Not much is known about Baker except that he was born on Sept. 23, 1949 and died at age 20 on March 31, 1970. Baker served in the U.S. Army as a Specialist Fourth Class.

Fields, a good friend of the Eckles brothers, grew up in the Lake Pointe area of Plymouth Township. He was the third Fields child to be born to Bess and Lawrence Fields. As a youth Fields was a "tender, sensitive, non-aggressive person," said his mother.

"He was a quiet kind of kid," she said. "He didn't have an active social life."

Fields graduated from Plymouth High School in 1966 and was drafted in the U.S. Army in 1968, while working for the phone company.

Serving with an airmobile helicopter rescue team as a radio operator, Fields, a Specialist Fourth Class, saw action helping retrieve wounded soldiers (and soldiers under fire) from outposts in the jungles of South Vietnam.

On Valentine's Day of 1969 Fields was killed when the helicopter he was in was hit by enemy fire and then crashed and burned. His unit had been on its way to help another ground unit under fire. Fields was just 20 at the time of his death.

Just a month earlier he had been named a soldier of the month in his outfit, said his mother. Fields was



JAMES T. FIELDS

awarded a Bronze Star and a Purple Heart

A note on sources

This writing project could not have been completed without the hard work and full cooperation of John Pappas.

Just as important was the full cooperation and understanding of the family members that were interviewed for the portraits (more than a dozen interviews with family and friends were conducted).

Besides those interviews, information was gleaned from official

Army letters, telegrams and records. The letters of the men from Plymouth-Canton who died were also used both for background and in the stories.

There are numerous books and magazine articles about the Vietnam and Korean "conflicts" and the men who fought in them. Some of those books were used as sources of background information.

KEN VOYLES

THE CHECK'S NOT IN THE MAIL

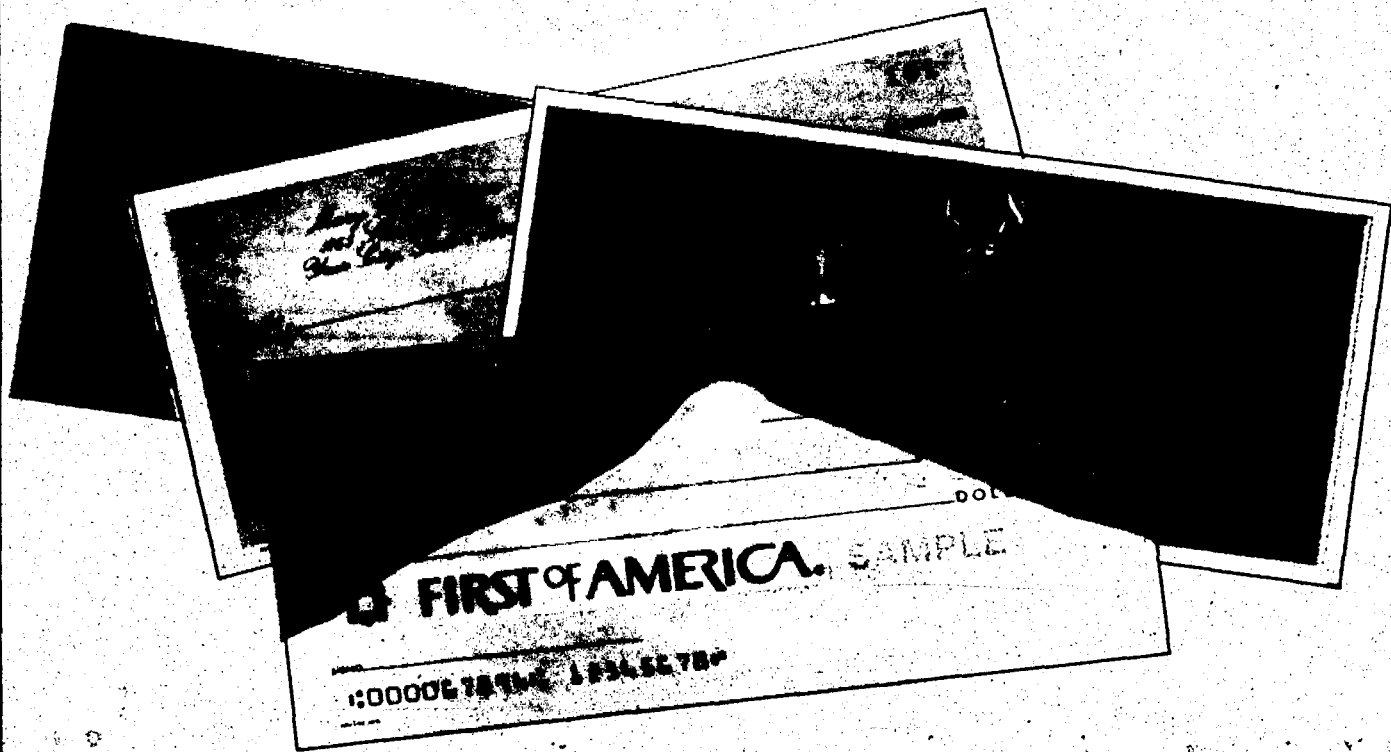

Does Your Bank Return Checks With Your Statement ???

If your bank is not returning your canceled checks monthly, then check out our checking. Monthly return of your canceled checks is just one more way First of America provides "Quality Service."

Trade your old checks for \$10 with this coupon when you open a checking account with us.

NAME _____

ADDRESS _____

PHONE _____

 **FIRST OF AMERICA.**
459-9000

Member FDIC.

4th of July Sale!

**25% Off
All Bird
Feeders**



Over
25
styles
in
stock

**Suncoast IND
Edging**

reg. 8.99
\$4.99
20 ft. length

**All Lawn
Fertilizers
30%
Off**



**Shrub
Sale**

over 72 varieties
of 1 gallon size
reg. \$6.99 ea.
\$4.96



**PLYMOUTH
NURSERY
and GARDEN CENTER**

453-5500

HR5 Map 521 966
Sun. Rd. 136
Canton, MI 48106
7-8-89

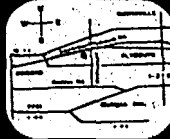

9900 Ann Arbor Road
Just 7 miles west of I-275

Canton residents seek P-C Schools annexation

BY JOHN BRODERICK

Some students living in a Canton subdivision may be changing school districts — should their parents have their way.

Residents of the Greenbrook Village Subdivision at Palmer and Canton Center Roads have filed a petition to have the subdivision annexed by the Plymouth-Canton Community School District.

The 55 K-12 grade students living there now attend Wayne-Westland schools, but actually live in Canton.

"We're like an island out here," said Don Hull, a Greenbrook resident, and organizer of the petition drive.

"We really feel more a part of the Canton community, and feel our kids should be going there," he said. "I received a piece of mail from Wayne-Westland which had a map of the district on back — we were not even on the map. Their school buses actually drive through the Canton district to get to us."

The decision to transfer the property ultimately rests with the Wayne County Intermediate School District's Board of Education, which is expected to hold a hearing on the subject during the summer.

Dennis O'Neal, superintendent of the Wayne-Westland schools, said he is opposed to the move.

"We're an in-formula district — the loss of 55 students will certainly not help us," he said. "We've addressed a number of concerns of the residents there over safety — we've made a number of improvements at the Walker Elementary, such as a horseshoe drive, and a slow down lane on Michigan Avenue."

Hull said that in an informal poll of the 148 homes in the subdivision, 109 voted for the move, nine against, and the rest were either undecided, or could not be reached.

Plymouth-Canton's Superintendent John M. Hoben said that another neighborhood, which attends the Belleville schools, has also expressed interest in the Plymouth-Canton schools.

Hoben said that the residents may be under the impression that if the move were to be approved, those students would attend the nearest school to the subdivision.

"Those schools (in southern Canton) are busting at the seams," he said. "At the elementary level, the nearest school at which we could accommodate them would probably be farther away than where they attend now."

Plymouth-Canton school board members said Monday that they would discuss both issues at a meeting in July.



FEED RITE PET SUPPLY

42432 Ford Rd. (at Lilley)
Canton Plaza
(next to Johnson's
Restaurant)

Complete line of foods and accessories for all pets.

**\$3.00
OFF
Any**



40 or 50 lb. Bag of
Dog Food
Expires 7/31/89. Offer not valid
with any other offer or coupon.

**\$1.00
OFF**



Any Bag of Cat Food
Not valid with any other offer or
coupon. Expires 7/31/89.

**\$5.00 OFF
Any \$20
Purchase**
or more excluding food.
Expires 7/31/89.
Not valid with any other
offer or coupon.

**Full Line
of
Grooming Supplies
For All
Pets**



**FEED RITE PET SUPPLY
ENTRY FORM FOR
FREE PRIZE GIVEAWAY**

NAME _____
ADDRESS _____
PHONE _____
Offering to be held Sat., September 23, 1989

**Full Line
of
FLEA PRODUCTS
20% OFF**

Not valid with any other offer or
coupon. Expires 7/31/89

**NOW THREE LOCATIONS
TO SERVE YOU**

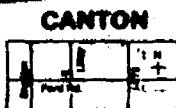

42432 FORD ROAD
CANTON
891-4477

LINCOLN PARK

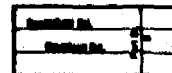

2875 FORT STREET
2 blocks South of Greenfield
Lincoln Park • 899-0000

DEARBORN HEIGHTS



5841 ANN ARBOR TRAIL
2 blocks W. of Telegraph
Dearborn Heights • 895-0000

Blackwell Inc.

**SAVINGS
CELEBRATION**
OVER 500 CARS AND TRUCKS AVAILABLE

4th of July

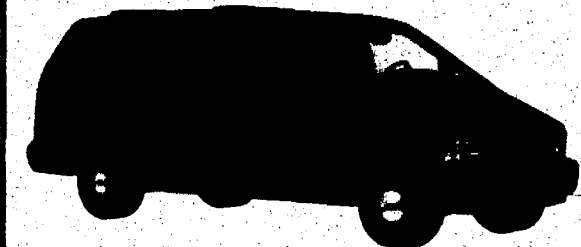

**1989
AEROSTAR
EXT**

S.V.P. 401, dual capt. chairs, 7 passenger, air conditioning, privacy glass, ir window wash/wipe. Speed control/tilt wheel, engine 3.0 liter, XL, auto O/D trans, P215/75R-14SL BSW, all season, electric AM/FM stereo radio/clock, elect. rear window defroster, pwr convenience grp. Stock number 8966.

WAS \$16,846

YOUR PRICE \$13,899*

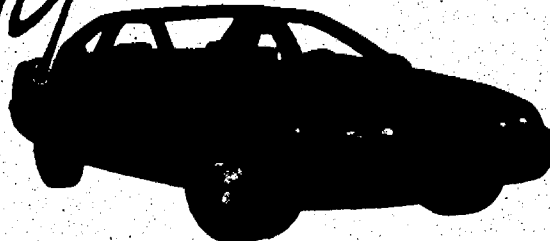

1989 THUNDERBIRD

Dual electric remote mirrors, bright window moldings, AM/FM stereo cassette, tilt wheel, speed control, illuminated entry, power lock group, 6-way power driver & and passenger seat, styled road wheel covers, defroster, luxury light/convenience group, 3.8 liter EFI V-6 engine, automatic overdrive transmission, P205/70R15 black sidewall tires, clearcoat paint. Stock number 4830.

WAS \$17,289

YOUR PRICE \$13,207*

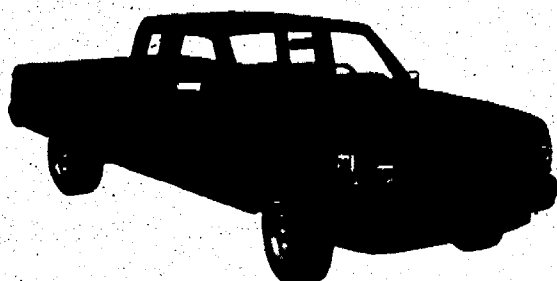

1989 RANGER SUPERCAB XLT

XLT trim, deluxe two-tone paint, XLT equipment group, chrome rear step bumper, AM/FM stereo radio with cassette/clock, tachometer, vinyl rear jump seat, 2.3 liter EFI engine, 5 speed manual overdrive transmission, P215 steel all season tires, silver metallic accent, 125 wheel base. Stock number 8796.

WAS \$12,129

YOUR PRICE \$8998*



1989 FESTIVA L PLUS AUTOMATIC

1.3 liter EFI 4 cylinder engine, automatic transaxle, P145/70SR12 black sidewall tires. Stock number 5883.

WAS \$7405

YOUR PRICE \$6298*

*Plus tax, title, destination, includes manufacturer's discount & rebate deducted.

Blackwell Inc.

41001 Plymouth Rd. (near Haggerty) 453-1100



Friends & Neighbors

Lights, camera, action

Wacky stunt may lead to fame

BY LAUREN SMITH
WDIV's "Stupid Tricks" contest had to be for those people who believe they have what it takes to perform the outrageous, the zany, and the wacky.

And do it live in front of an audience.

Dave Ijaz, of Canton, had a real inkling to enter with his "act." He even made it to the finals.

Now Ijaz has a chance to win an expense-paid trip to "Latenight with David Letterman" and \$300. The tape of his performance would then be sent to the Letterman show for viewing.

What did Ijaz do to reach the final stage of this most unique contest?

In his words:
"I can encompass the top of a glass with my mouth and consume a liquid contained in it."

On Thursday, he did just that. To top it all off, "the liquid" was salsa with ground red pepper added.

Why salsa? Well, in honor of Taco Bell, another sponsor of the contest. He said the salsa alone is too salty and he "counteracts" the saltiness with the pepper.

"It's easier for me to swallow," Ijaz said of the pepper additive, noting that it helps the mixture "go down faster."

The contest involved more than 30 contestants with the three finalists chosen by a panel of six judges on the basis of originality, creativity, and humor.

For the next two weeks, the tapes of the three finalists will be aired on television and viewers will be able to vote for the final grand prize winner.

Ijaz is a graduate from Dearborn Divine Child and student at the University of Chicago, where he first entertained other students with his bizarre stunt. He has been practicing since childhood.

Ijaz remembers the first time he performed the trick publicly was on March 6, 1983.

"Finals week was about to start (so

everyone was really tense," said Ijaz. "Everyone thought the trick was worthy of going on Letterman."

"I hope I can get on the David Letterman show," he said. Ijaz said he has been a "fan of Letterman since even before he had a show." He remembers watching him when he started with daytime in 1982.

Ijaz also recalls seeing a movie preview with Jerry Lewis performing a similar trick. At that time he had never seen anyone besides himself accomplish the stunt.

Ijaz said it "made me go further and try to do the largest size possible."

He feels that "at this point I am probably the best at it. I can consume practically any sort of liquid, even solids."

"I think I'm good at it."
Of the risks involved with such a feat, Ijaz said that some people are "frightened of the fact I use real glass."

But Ijaz can even perform his act with a beer mug, avoiding accidents or injuries generally, though he once cut himself on a rough edged glass.

Now he is very, very careful -- advising any potential imitators to use small glasses or plastic ones.



Dave Ijaz, of Canton, performs his "stupid trick" Thursday. Ijaz swallowed a glass full of salsa. (Crier photo by Chris Farina)





Rubbermaid Cleatmats™
With "teeth" that hold fast. 3/16" thick. For medium high and textured carpets.

Stock Size	List	SALE		
2358 36"x 48" with lip	67.73 ea	33⁸⁷	48"x 60" 2362 with lip	103.69 ea 51⁸⁵
2360 45"x 53" with lip	84.84 ea	42⁴²	48"x 60" 2373 rectangular	112.35 ea 56¹⁸

Rubbermaid Guarantee
If the Rubbermaid mat ever breaks, chips, cracks or shatters (under normal use) we'll replace it FREE!

PLYMOUTH OFFICE SUPPLY
FAX 453-9908 **453-3590**
840 Ann Arbor Trail • Plymouth
SALE ENDS JULY 31, 1989



FOR THE
LATEST
NEWS IN
YOUR
COMMUNITY
THE
COMMUNITY
CRIER
453-6900



Tell it to Phyllis

By Phyllis Redfern



Annette Ruggiero, daughter of Tony and Janet Ruggiero of Plymouth, graduated with highest distinction (4.0) in the College of Business and Finance at Colorado State University. While at Colorado State she was awarded the Farmers Insurance Scholar Award, Presidential Scholar and Colorado Scholars' Award. She has accepted a position with the Hewlett Packard Company in Fort Collins.

Margaret Welch of Canton has been promoted to Assistant Manager of the Laura Ashley Mother and Child Shop in the Somerset Mall. She is a recent graduate of Eastern Michigan University.

Students from Canton who received degrees from Central Michigan University are: Stacey Champagne of Alton, BS; John Garback of Candlewood, MS; Paul Gothard of Gainsborough, Magna Cum Laude, BS; Angela Kocik of Hanford, BS; Timothy Kryska of Fox Valley, MS; Douglas Storbeck of Post Mill Court, BS; Lucille Jeanet of Drexel, MS; and Portia Worthy of Trails Court, MA.

Plymouth students who received degrees are: Mark Blaesser of Canton Center, BS; Anthony Corte of Ann Street, MS; Thomas Daratony of Cove Court, BS; Deanna Gasparott of Muirland, BS; Kimberly Henshaw of Terry, BS; Dianne Iannello of Tavistock, BS; Susan Moyer of Hillcrest, BAA; Thomas Penland of Burroughs, BS; Marc Tindall of Morrison, BS; and Trisha Villeneuve of Dewey, BS.

Plymouth students receiving degrees from Miami University in Ohio are: Christine Theodore of Haverhill, BS in Art; and Jennifer Wells of Haverhill, BS in Business.

Anne Lucchetti received the Katherine Hicks Glathart Award in Speech Communications at Albion College's annual Honors Convocation. She is the daughter of Janice Lucchetti of Plymouth Road.

Sgt. Matthew Levesque with the 7th Infantry Division, Fort Ord, CA., joined soldiers from the British, Canadian and Australian armies in the combined brigade-level field exercise, "Caltrop Force" at Fort Hunter-Liggett, CA. A cannon crewman, he is the son of Ronald and Mary Levesque of Westchester in Canton and a 1986 graduate of Canton High School.

Army 2nd. Lt. Stephanie Brendel, daughter of Joseph and Kathryn Brendel of Fieldstone Drive in Canton, has arrived for duty at Fort Hood, TX.

Air Force Airman Michael Wilson, son of Wilfred and Sandra Wilson of Arlington in Canton, has arrived for duty at Robins Air Force Base, GA. He is a 1985 graduate of Salem High School.

Jennifer Gansler, a sophomore at Kalamazoo College, was named to the Dean's List. She is the daughter of Sue Gansler of Sunset and Karl Gansler II of Mill Street in Plymouth.

Marine Military Academy Cadet Joel Kealohaina Warner, son of Mr. and Mrs. Tom Warner of Plymouth, was recently promoted to cadet Private First Class.



THE FINEST QUALITY REPLACEMENT WINDOWS & DOORS

Enjoy the Warmth & Beauty of Wood

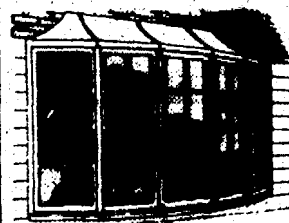

Energy Efficient
Weston Window
Replacement

595 Forest, Suite 7B
459-7835

Serving all of Northern Michigan
from our Gaylor office
(517) 732-0330

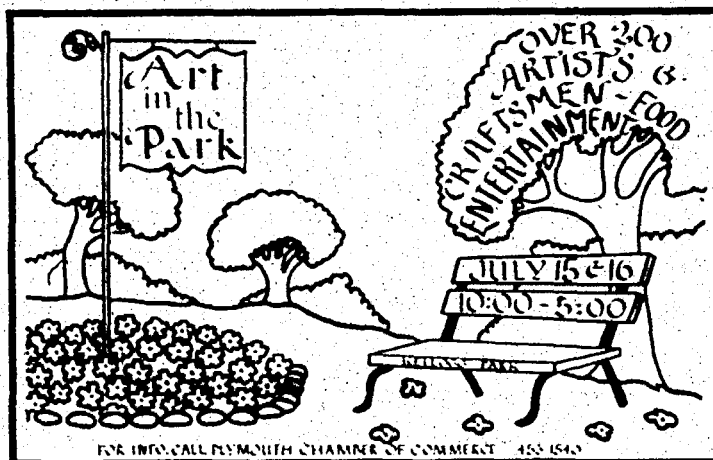

FOR INFO, CALL PLYMOUTH CHAMBER OF COMMERCE 453-1543

9.9%

NEW CAR LOAN FINANCING

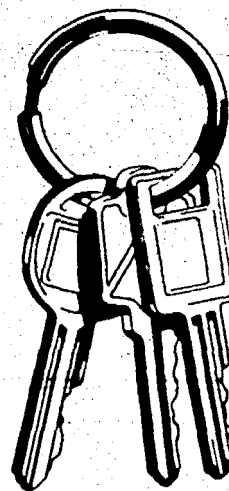

We've made it
easier for you to
get the key to that
brand new car
you've always
wanted with our
9.9% New Car Loan.



Community Federal Credit Union

Plymouth
453-1200

Canton
455-0400

Northville
348-2920



Equal Opportunity Lender

Garden Variety
of cut
Summer Flowers

Riber Floral Co.
728 S. Main St., Plymouth
455-8722
Daily Deliveries

MENARD BUILDERS, INC.
Custom Built Homes
YOUR LOT OR OURS
862-6200 or 455-2682
LICENSED BUILDER

What's Happening

To list your group's event in this calendar, send or deliver the notice IN WRITING to: The Crier, 821 Penniman Ave., Plymouth, MI, 48170. Information received BY NOON FRIDAY will be used for Wednesday's calendar (space permitting).



TO WIN THE
BUG BATTLE
use our **ARMY** of
EXPERTS

\$10.00 off 1st application

PEST CONTROL
BY
WAGENSCHUTZ

455-6313
GUARANTEED RESULTS

SAFE EFFECTIVE CONTROL
• Ants • Bees • Fleas • Spiders
• Moles • Mice • Roaches • Wasps
• And Many More

(Preventive Programs Available)

March Tire Co.
GOODYEAR

CERTIFIED AUTO SERVICE

INSTANT CREDIT to qualified applicants

MONDAY thru FRIDAY 7:30 A.M. - 7:00 P.M. SATURDAY 8:00 A.M. to 5:00 P.M.

AIR CONDITIONING SERVICE TEST

- Performance test system
- Leak test all connections and components
- Check heating and cooling systems
- Check drive belts and hoses

\$21.95
includes
1 Lb. Freon

WITH THIS COUPON • EXPIRES 7-15-89

FREE 12 POINT VEHICLE INSPECTION

WITH THIS COUPON • EXPIRES 7-15-89

4 WHEEL COMPUTER BALANCE AND ROTATION
\$19.88

WITH THIS COUPON • EXPIRES 7-15-89

PLYMOUTH

LUBE, OIL & FILTER

REGULAR \$19.00 **\$16.88**

UP TO 5 QTS. KENDALL PREMIUM ALL-SEASON OIL AND FRAM FILTER

WITH THIS COUPON • EXPIRES 7-15-89

COMPUTERIZED FRONT END ALIGNMENT
\$10 OFF

WITH THIS COUPON • EXPIRES 7-15-89

CANTON

Offer valid with this AD at the two participating centers until 7-15-89

SENIORFEST '89

The Plymouth Community Council on Aging is sponsoring Seniorfest '89 on Wednesday, Sept. 13 from 11:30 a.m. to 3 p.m. at Hines Park near Riverside Drive. Food and refreshments will be served. Lots of help and suggestions for entertainment needed. Call Carol at 455-6620.

FISH NUMBER CHANGE

Plymouth-Canton FISH will be changing its phone number at the request of their answering service, which is updating its equipment. The new number is 261-1011. Calls made from Plymouth and Canton to the new number will still be local.

PLYMOUTH CLASS OF '49 REUNION

The Plymouth High School Class of 1949 "The Nuggets" will celebrate their 40th class reunion Sept. 8-10. "Lookin' under for every rock," 1948 and 1959 class members also invited. Call Gerald D. Harder at 455-9137 or Joan Palmer at 453-5231 for information.

CANTON CRICKETS

Canton Crickets (Summer session), Canton's Pre-School Program for three and four year olds will begin July 6 and ends Aug. 15. Held on Tuesday or Thursday, 9:30 a.m. to 11:30 a.m. and 1 p.m. to 3 p.m. Cost is \$20 for six week session. Register at Canton Administration Building on first floor. Birth certificate required and child must be 3 by June 1, 1989. Openings still available. Call 397-5110.

GIVE BLOOD

Blood donations are accepted at the American Red Cross Livonia Donor Center, Bell Creek Office Plaza, 29691 W. Six Mile Road, Suite 100C, Livonia on Monday, Wednesday, and Thursday 2 p.m. to 8 p.m.; Tuesday and Friday, 10 a.m. to 4 p.m.; and Saturday 9 a.m. to 2 p.m. For an appointment or info call 494-2881 or 494-2856. Red Cross Bloodmobiles will be located in the following Northwest locations: Monday, July 10, Holiday Inn, 38123 W. 10 Mile Rd., Farmington Hills, from 10 a.m. to 4 p.m. Call Clif Taylor, 334-3575. Friday, July 28, K Mart No.3231, 5725 Sheldon Rd., Canton, from 12 noon-6 p.m. Call Roger Whithill 455-9700.

BASKETBALL COMPETITION

The Pepsi/NBA Hotshot Basketball Competition will be held Tuesday, July 11 at Eriksson School; Monday, July 17, at Hulsing; and Wednesday, July 19 at Hoben. Participants can test their basketball skills shooting from various spots on the court. It begins at noon on each date. Registration at 11:45 a.m. The competition is free. Boys and girls, ages 9-12, 13-15, 16-18. Call 397-5110 for information.

FLAG SALE

The Plymouth Historical Society will be selling flags from 11 a.m. to 1 p.m. on July 4th for 50 cents at the museum and on both sides of Main from the museum to Kellogg Park.

DAY CAMP

The third sessions of Day Camp will be July 3, 6, and 7 for both preschoolers ages 3-5 and children ages 5-11. Varied activities including games, projects, arts, crafts, hiking. The next counselors in training session for 12-14 year olds will be offered for five weeks July 24 to Aug. 25. For more sessions of Day Camp and information, call the Plymouth YMCA.



"ALL I KNOW IS WHAT I READ IN THE PAPERS"
Will Rogers

Each Wednesday, thousands of your friends and neighbors turn to The Community Crier to discover the latest news in Plymouth-Canton. It's a great place to let these people know about your business. From A to Z, let your potential customers know you're nearby and anxious to serve them. It's easy and inexpensive — why not call today?

453-6900

What's Happening

To list your group's event in this calendar, send or deliver the notice IN WRITING to: The Crier, 821 Penniman Ave., Plymouth, MI. 48170. Information received BY NOON FRIDAY will be used for Wednesday's calendar (space permitting).

Tuesday
18

SCHOOLCRAFT REGISTRATION

Schoolcraft College Summer in-person registration will be held today (June 28) from 9 a.m. to 7 p.m. The term begins on Wednesday, July 5. For more information or a free copy of the course schedule, call 462-4426.

YOUTH SUPERSTARS

A "Youth Superstars" competition is being held Sat. July 15 at 10 a.m. with a competition to find out who the best all around young athletes in Canton are. The age divisions are nine and under, 10-12, and 13-15 boys and girls. Sponsored by Canton's Parks and Recreation Department, the competition will be held at Griffin Park (Sheldon Road side). It is free to young athletes. Call 397-5110 for more information.

ART IN THE PARK

The 9th annual Art In The Park art show will be held on July 15 and 16 in and around the City of Plymouth's Kellogg Park. Hours are from 10 a.m. to 5 p.m. on both days. For more information, call 453-1540.

50-UP CLUB

St. John Neumann Seniors 50-Up Club will meet at the church on Warren Avenue on July 11, at 7 p.m. Guests and new members welcome. For more information, call Betty at 459-4091.

PCJBA GOLF OUTING

The Plymouth-Canton Junior Basketball Association will host a golf outing on June 28 at Mission Hills Golf Course to help raise funds for the program. The cost is a \$75 per person donation and includes 18 holes and cart. There will also be prizes, continental breakfast and a buffet dinner. For further information call 459-0046 or 455-1383.

FLAG KITS AVAILABLE

The American Legion Passage-Gayde Post 391 in Plymouth currently has flag pole kits for sale. The kits include a cotton flag, a three section pole with ground socket plus rope and all hardware and a top eagle. The cost is \$30 per kit. For further information about getting a flag kit call 453-7629.

FLAG SALE

The Plymouth Historical Society will be selling flags from 11 a.m. to 1 p.m. on July 4th for 50 cents at the museum and on both sides of Main from the museum to Kellogg Park.

VOLUNTEERS NEEDED

Our Lady of Providence Center in Northville is accepting volunteers to assist the staff in supervision of developmentally impaired girls in the classroom, work training program, residential program and the Volunteer Visiting Foster Family program. All ages welcome. Call Sister Theresa Tamburo at 453-1300.

OMNICOM WORKSHOP

The Programming Department of Omnicom Cable will be offering a public access Portable Camera and Editing workshop one night a week for six sessions beginning on June 28 from 7-9 p.m. and running through Aug. 2. To register call 459-7335 or 459-7391. There is a \$10 registration fee.

HISTORICAL EXHIBITS

The Plymouth Historical Museum, located at 155 S. Main in Plymouth, is currently exhibiting wedding dresses from 1840-1960, bridal accessories, and Victorian wedding gifts. There is also a current special exhibit featuring Buster Brown memorabilia. The newest permanent exhibit is on the Ford Village Industries. Admission is \$1 for adults, and 50 cents for children. It is open on Thursday, Saturday, and Sunday from 1-4 p.m.

MAKING IT ON OUR OWN

"We're Making It On Our Own", a conference for people with developmental disabilities, will be held Saturday and Sunday, July 29-30 at Madonna College in Livonia. The event is sponsored by the Interdependent Living Council of Michigan. For more information, call John Sigworth at 455-8880, ext. 227.

AMERICAN BUSINESS WOMEN'S ASSOCIATION

The MAIA Chapter, American Business Women's Association, is interested in forming a new chapter in the Plymouth-Canton, and Westland-Novi areas. ABWA is a non-profit organization dedicated to the professional and personal advancement of women. They are planning two social/networking meetings in mid-June and mid-July for potential members. For more information call 451-7205.

MUDS N SUDS

The Plymouth Jaycees are hosting their 1st Annual Muds N Suds outing on June 30. They will travel to see the Toledo Mud Hens take on the team from Syracuse at 7 p.m. Everyone between the ages of 21-39 may attend. There will be car pooling from the Plymouth Cultural Center parking lot at 3:30 p.m. \$4 box seat tickets may be purchased at the stadium game night. For details call Cindy O'Day at 459-8659.

FIRECRACKIN' SAVINGS
Labadies Casual Furniture
 see us at our new location
41812 FORD RD.
981-9070
 Next to Man's Doll Center

WJLH
 THE BOTTOM LINE
NewsFile at Five
Weekdays at 5:00 p.m.
 PLYMOUTH CANTON'S RADIO STATION

The ART STORE
NEW LOCATION
ART STORE
SUMMER ART LESSONS
ALL AGES
 • Custom Framing
 • Art Supplies
 • Drafting Supplies
 Discount to Teachers
 Art Students and
 Senior Citizens
42727 Ford Road
 (Canton Corners)
455-1222 or 981-8600
 (In Plymouth) (In Canton)

★ **PRE-GRAND OPENING SALE** ★
ACCURATE FLOOR COVERING GROUP, INC.
 COUPON
50% OFF LABOR
 (Expires 7-31-99)
 • CARPET ONLY •
 • 20 YARD MIN. ORDER •
SAVE NOW
Accurate Floor Covering Group, Inc.
 COUPON
 Mon.-Fri. 9 to 9
 Sat. 9 to 6
 Sun. 12 to 4
 44555 Joy Rd. Canton **454-4150**

Featuring Carpets From America's Leading Mills
 • Armstrong • Philadelphia
 • Gallery • Queens
 • Mohawk • Stevens
 Vinyl Floors By...
 • Armstrong • Congoleum • Tarkett
 Hardwood Floors By...
 • Boen • Hartzo
 Custom Installation
 Residential • Commercial

Award for Excellence

RECOGNITION OF
 SUPERIOR
 ACHIEVEMENT
 IN SALES
 PERFORMANCE,
 CUSTOMER SERVICE,
 ADMINISTRATION,
 FACILITIES AND
 COMMUNITY RELATIONS

Fox Hills 455-8740
 CHRYSLER-PLYMOUTH
 111 W. Ann Arbor Rd. (1 mi. West of I-275 at Lilliey) • Plymouth

Floats, clowns, bikes

Strike up the band for July 4th

Continued from pg. 1

The parade will begin at 1 p.m. this year at East Middle School. The procession up Main Street toward Kellogg Park will continue past city hall and end around the Central Middle School.

The parade is expected to last approximately an hour and a half. Viewing can be taken in from along Main Street and around the reviewing stand, which will be positioned at the end of the route.

Pamela Conn, a City of Plymouth resident and the 1988 Academy Award winner for the documentary "Young at Heart" with her partner Sue Marx, will serve as grand marshal.

Conn also won an Emmy nomination for her original song "Foxy Lady." It was composed for the 1988 Emmy winning film "Encore on Woodward: Detroit's Fox Theatre." The Detroit News named Conn a 1988 Michigianian of the Year.

And listen for that magic voice of Denny Campbell. He'll be manning the microphone again this year.

Also, check out the clown competition for anyone 16 years and older.

A bicycle decorating contest is open to all children between the ages of seven and 13 years old. Applications are available at Jerry's bicycles, the Dunning-Hough Library, or at the Plymouth Parks and Recreation office in the Cultural Center. The bicycles will lead off the parade this year.

A Peewee Herman character and other characters from the Wizard of Oz will also join along the parade route.

The Plymouth Fife and Drum Corps and Michigan Scottish pipes and drums and a calliope will perform this year. The Plymouth Polish Centennial Dancers will be present again this year and the Girl Scout and Boy Scout troops.

A veterans group POW/MIA group is also tentatively scheduled to participate.

There'll also be plenty of noise from the Plymouth area fire and police department who will deploy trucks to help lead the way for the parade.

Local officials and notables will also be on hand for the march.

The Elks will have a float in the parade this year and so will the Westland Jaycees. McDonalds has also sponsored a float and one Girl Scout Troop has entered one.

WSDP (FM-88.3), the student radio station at Centennial Educational Park (CEP), will be broadcasting parade music throughout the

parade and will also have a pre-parade show with information about the event.

Before the parade this year the dedication of the new memorial monument to soldiers from Plymouth-Canton will be held.

The dedication -- in front of the Wilcox House -- will begin at 11 a.m. and include several short addresses, the Plymouth Fife and Drum Corps and a special honor guard. That honor guard will begin a 24-hour vigil in front of the new monument on Monday (July 3).

Some of the tentative

sponsors include: Sutherland and Yoe, Finlan Insurance Agency, Caviston Insurance Agency, Cale and Printer, Jim McKeon, The Community Crier, Bruce Mirto, Sideways, the Patrician Group, and Vermeulen Funeral Home.

The chairperson of the parade this year is Tonya Smith of the Plymouth Jaycees. A Community Advisory committee helped the Jaycees organize and promote community participation. Mary Roehr, Fred Hill, Jim Jabara, Kriss Rautio, Lois Worthy, and Paul Sincock served on this committee.



Parade goes, including these kids, get ready for last year's Fourth of July Jaycees Parade. This year the parade will again be held along Main Street, but will head from south to north. (Crier photo)

Plan for fireworks muddled again

BY LAUREN SMITH

Plans for fireworks during the Fourth of July in the City of Plymouth have gone up in smoke for the second straight year in a row.

Last year the continual drought prevented the festive pyrotechnics display. This year, though, the major sponsor of the \$10,000 event backed out.

Chuck Lowe, a member of the Plymouth Jaycees also said that "a lot of people are hesitant about blowing \$10,000 into the air."

The Jaycees have been the main organizers of the July 4th celebrations in Plymouth for many years.

Tonya Smith, chairperson of this year's parade and holiday activities, said the Jaycees will "work hopefully to get them back next year...if we have community support." The main problem, she said, is the "lack of time and lack of money."

It is very difficult to find sponsors, she added. Coors has sponsored the fireworks display in the past.

The GREAT OUTDOORS

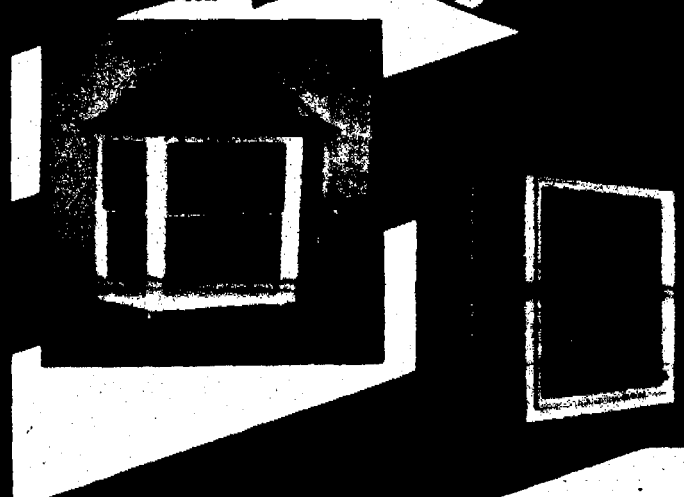

W. Smith Lumber and Supplies
the very best treated lumber as well as
custom doors and windows, skirting
decorative hardwoods, paneling
paints, and stains. Our
products is Western

W. Smith Lumber & Supplies

Owned and Managed Since 1946
Mon.-Fri. 7:30-5:30 • Sat. 8:00-4:30
28575 Grand River • Farmington Hills
474-6610



Last year the veterans took part in the parade on the patriotic holiday. (Crier photo)

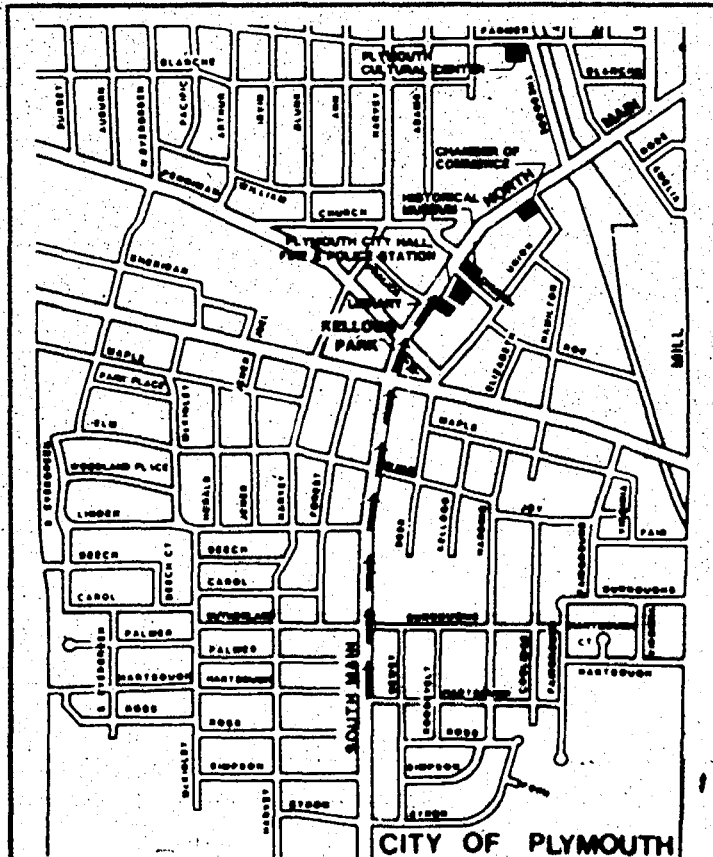

The route

Above is a map of the route for this year's Fourth of July Plymouth Jaycees parade. The route is reversed this year.

Pancake breakfast

All you can eat

Residents can wake up on the Fourth of July Tuesday and take the family to the all-you-can-eat Tyrian 500 F & AM Pancake Breakfast held yearly at the Plymouth Masonic Temple.

Serving runs from 8 a.m. to noon. The Temple is located at 730 Penniman Ave., fronting Kellogg Park.

Proceeds from the breakfast will go to local charities.

Tickets can be purchased at the door. The cost is \$2.50 for adults, \$1.50 for children under 12 (and 50 cents for extra sausage).

For more information call Bill Heller at 459-2374.

Flags for sale

The Plymouth Historical Society will be selling hand held flags for 50 cents on the Fourth of July this year (Tuesday).

These symbols of American patriotism will be available from 11 a.m. to 1 p.m.

They will be sold in front of the Plymouth Historical Museum and on both sides of Main Street from Kellogg Park to the museum.

The flag sale will help benefit the Plymouth Historical Society.

The Plymouth Historical Society has also entered Margaret Dunning's antique car into the parade again this year. It has won awards in past year's parades.

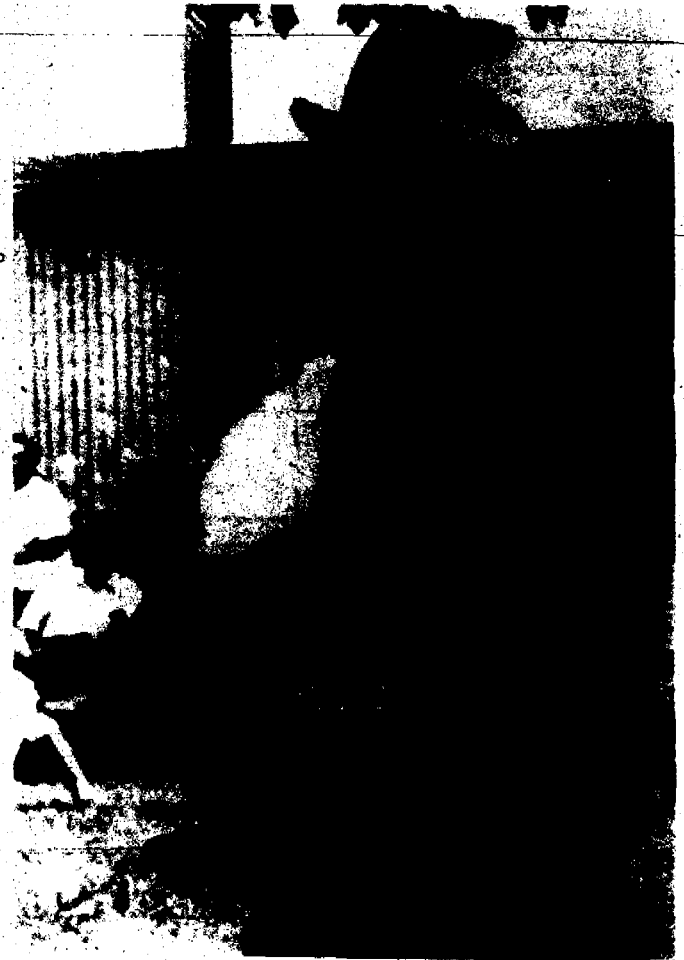

A father and his child endure the scorching weather which characterized last year's holiday. (Crier photo)



We Want To Be
YOUR
Master Dealer!

'89
Broughams
\$21,995

'89
Eldorados
\$23,995

Cadillac

Your Caring, Servicing, Selling Dealer

ALL ARES... •

Watch out for illegal explosives

Fireworks safety stressed

BY RAY SETLOCK

Fireworks are abundant at this time of year. As the Fourth of July holiday approaches, fireworks and their safe use become an important issue.

In The Plymouth-Canton Community, anything that shoots, spins and jumps is considered illegal, according to Canton Fire Marshall Art Winkel.

But that doesn't seem to stop firework outlets from selling these illegal novelties, he said.

Canton Police spokesperson Dave Boljesic said the township police force cracks down on those selling illegal fireworks.

"We try to enforce the law concerning those who use and sell illegal fireworks," said Boljesic. "We really don't have that big of a problem here."

One trouble spot which was highly publicized last week is the state lawsuit slapped against Tri-city Fireworks Inc. of Canton, on Thursday.

Tri-City, which is located on Michigan Avenue at Beck Road, has been cited for selling illegal fireworks and putting them in the hands of people who are not qualified to use them.

The Tri-City owners refuse to comment on the lawsuit except to say that everything they sell is of a legal stature.

Tri-City attorney Stephen Taylor calls the lawsuit "absurd." He says

everything Tri-City sells is within the law.

"I know it's a legal operation," said Taylor.

Another fireworks operation in Canton, Burda Brothers Fireworks, insist that they sell only legal fireworks. The owners say they know the law and stay within its limits.

Elissa Burda is also the secretary of the Fireworks Association of Michigan. She said her fireworks business is an all-year long operation, but admits business heats up as the Fourth of July approaches.

"We are a wholesaler, so we are busy for the entire year," Burda says. "The Fourth of July is just a climax for us." The Burda Brothers put together the recent fireworks display as part of the Canton Challenge Festival.

Come the Fourth of July, many residents of the community will be "playing" with these sometimes dangerous toys.

All legal fireworks come with their own cautions. It is important to read the label before lighting the fuse, said fire officials.

Last Fourth of July, the community was plagued by field fires due to the drought, but Winkel does not see that as a problem this year, as rain has fallen considerably more than during last summer's drought.

Winkel said that as long as people practice "good common sense," the holiday will be a safe one.

Enter parade contest

PLYMOUTH JAYCEES
4TH OF JULY PARADE
ANNUAL BICYCLE DECORATING CONTEST

OFFICIAL ENTRY FORM

TODAY'S DATE _____

NAME _____ FATHER'S NAME _____
AGE _____ (7 through 13 YEARS ONLY) MOTHER'S NAME _____

HOME ADDRESS _____
CITY _____ STATE _____ ZIP _____
HOME PHONE NUMBER _____

TYPE OF BICYCLE TO BE DECORATED _____

JUDGING WILL BE BASED ON THE FOLLOWING:

- 1) ALL BIKES MUST HAVE AT LEAST TWO (2) WHEELS;
- 2) COLOR THEME MUST BE RED, WHITE & BLUE;
- 3) EMPHASIS ON CREATIVITY/ORIGINALITY

JUDGING WILL BE DONE BEFORE THE PARADE. PRIZES WILL BE AWARDED COMPLIMENTS OF JERRY'S BICYCLE SHOP IN PLYMOUTH.

FOR FURTHER INFORMATION OR QUESTIONS, PLEASE CALL BRUCE HARTDEGEN OR TONYA SMITH OF THE PLYMOUTH JAYCEES AT 420-0732 OR 455-9308.

Here's the entry form for this year's Fourth of July Parade Bicycle Decorating Contest.

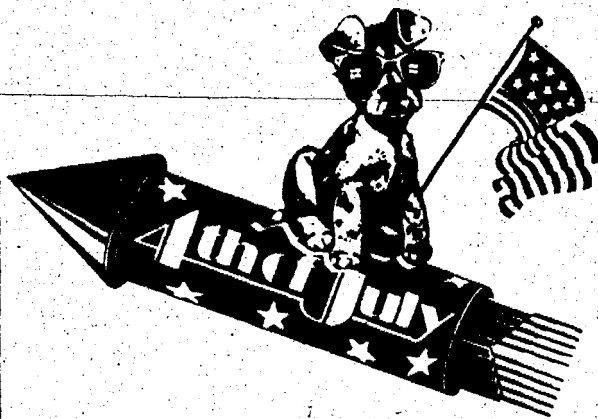

CELEBRATE THE 4th of JULY WITH AIR CONDITIONING

We have the unit to
take care of
all your needs!

Heating
Air Conditioning
Refrigeration

Service
& Installation

CALL
TODAY
459-1954
SELECT
AIR
SYSTEMS

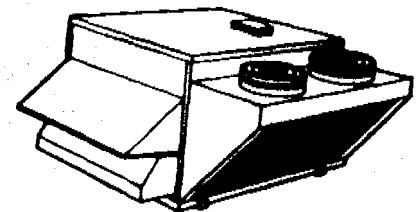

Residential & Commercial Professionals

693 Maple, Plymouth



Places to be

Starts at noon

VFW hosts cookout

The Mayflower Lt. Gamble VFW Post No. 6695 will host its annual Bar-B-Que on July 4th (Tuesday) at the VFW Memorial Home, 1426 S. Mill Street in Plymouth, for hungry holiday celebrants.

The meal will be served from noon to 6 p.m. (unless they are sold out early). Indulge that holiday appetite with BBQ'd chicken, a potato, cole slaw, and a roll.

The cost for the festive meal is \$4.50 per person. It is suggested that tickets be purchased early.

For more mouth-watering information call 459-6700, 981-1231, or 349-6366.

Art in park coming

The 9th annual Art In the Park art show will be held on July 15-16 in downtown Plymouth and will feature the work of more than 215 artists and craftsmen.

Artists will be coming from all over the United States and Canada this year for the annual fete.

Many of the artists have won awards or other recognition on the national level, and several have work in permanent collections. One artist has her own TV show.

Everything sold is hand crafted, and the artists are there to demonstrate

techniques. There will be a wide variety of art including oil, watercolor, folk art, photography, leaded glass, wood work, jewelry, and clothing.

There will also be food and entertainment during the show.

Art in the Park will be held in and around Kellogg Park from 10 a.m. to 5 p.m. on both days.

Main Street, Penniman Avenue and Union Street will all be blocked off for the show.

For more information call the Plymouth Community Chamber of Commerce at 453-1540.

Museum features gowns

The Plymouth Historical Museum is currently exhibiting wedding dresses from 1840-1960. The exhibit includes 15 bridal gowns, in addition to bridal accessories, garters, wedding shoes, and lace items. Wedding gifts, such as silver, cut glass, and painted china, will also be displayed.

Special exhibits at the museum include an extensive collection of Buster Brown memorabilia and collector license plates, dating from

1912. Also included is the newest permanent display on the Ford Village Industries tracing the history of the Village Industries project from 1930-1945 through artifacts, graphics, and video resource material.

The Historical Museum is located at 155 S. Main St. Hours are 1-4 p.m. Thursday, Saturday, and Sunday. The cost is \$1 for adults and 50 cents for children.

Cricket sign-up on tap

Canton Crickets, a preschool program for three and four year olds, will be registering for the summer session.

Classes meet twice a week from July 6 through August 15. Activities include crafts, games, stories, special events, and snack time.

Registration is June 3 at 8 a.m. on the first floor of the Canton Administration Building.

Birth certificate is required and the child must be three by June 1. Cost is \$20 for Canton residents only.

Call 397-5110 for more information.

S'craft holds registration

Schoolcraft College Summer in-person registration will be held on today (June 28) from 9 a.m. to 7 p.m. The summer term begins Wednesday, July 5.

Day and evening classes are held at the main campus in Livonia, as well as Radcliff in Garden City. New course offerings include: Introduction to Health Careers, College Notetaking, College Reading Studies, and Introduction to Professional Cooking.

Schoolcraft College is located at 18600 Haggerty Rd., between Six and Seven Mile roads, in Livonia.

For further information or a free copy of the course schedule call 462-4426.

Export mission planned

Madonna College's Great Lakes Export Trade Mission will focus on those countries identified as most interested in imports of automotive products, including related tools and accessories.

Scheduled for September 14-23 this year, the trade mission features area business persons who will attend five trade shows in Hannover and Frankfurt, Germany, and in Bir-

mingham, England.

Having been granted the status as an Industry Organized Government-Approved (IOGA) Trade Mission, the mission will benefit from the advice and assistance of the U.S. Department of Commerce.

For more information or to register for the trade mission, contact Dr. Charlotte Neuhauser at 591-5116.

**START THE "4th" WITH
A
BANG
BREAKFAST AT**

Silverman's

Open
7th June - 4th
No open
Sun - 3th

**Then
BROASTED CHICKEN
By the Bucketful**

Broasted Chicken is served brown, tender and moist. It's prepared with special equipment, searing the chicken, cooking it to the bone while holding in its natural juices.

Buckets of chicken are served with American fries or broasted potatoes and cole slaw.

Small Bucket (8 pieces).....	*7.99
Medium Bucket (12 pieces).....	*11.25
Large Bucket (16 pieces).....	*13.95
Extra Large Bucket (24 pieces).....	*19.75

We'll be happy to fill your order for any size picnic or party (Orders over 100 pieces please allow 24 hours notice)

WE DO THE COOKING YOU HAVE THE FUN

CALL AHEAD FOR CARRY OUT

Or Try A Broasted Chicken Dinner 4 Different Pleasers To Choose From Eat In Or Carry Out

9468 S. Main Plymouth
459-2066

22870 Pontiac Trail S. Lyon
437-7880

41602 10 Mile Rd Novi
349-2885



Community Deaths

Stowe, a teacher

Grace M. Stowe, 95, of Detroit, died June 8 in Ann Arbor. Services were held June 12 at the Schrader Funeral Home with the Rev. Philip Rodgers Magee and Mr. Sanford Burr officiating.

Miss Stowe was a teacher for 40 years in the Detroit School System. She came to the Plymouth community in 1953 from Detroit. She was a member of the First Presbyterian Church of Plymouth, the Plymouth Historical Society, and the Plymouth Women's Club. She graduated from Eastern Michigan University.

Survivors include: nephew Russell A. Stowe, of Montegut; great niece Margaret Read, of Arizona; great nephews George Stowe, of Florida, and William Stowe, of Montegut.

Burial was in Riverside Cemetery in Plymouth.

Memorial contributions may be given to the Plymouth Historical Society of the First Presbyterian Church.

Konazeski, Ford employe

Frank J. Konazeski, 69, of Plymouth, died June 11 in Allen Park. Services were held on June 14 at Schrader Funeral Home with the Rev. Fr. Andrew J. Forish officiating.

Mr. Konazeski was retired from Ford Motor Company in 1978 after more than 30 years of service. He came to the Plymouth community in 1922 from Detroit. He was a member of the V.F.W. Post No. 6695 Mayflower-Lt. Gamble, the Plymouth Elks No. 1780 B.P.O.E., and the Polish-American Legion No. 166. Mr. Konazeski served with the Army Air Corps in World War II. He was also a volunteer at the Ann Arbor Veteran's Hospital.

Survivors include: dear friend Clara Everson, of Plymouth; brother Alex, of Livonia; sisters Mary Rudick, of Indian River, Connie Johnson, of Plymouth, Florence DeVriendt, of Roscommon, Jennie Mellinger, of Northville, and Margaret Robinson, of Northville.

Burial was in Riverside Cemetery in Plymouth.

Cardinal, WWII veteran

Roy E. Cardinal, 65, of Lakeland, FL, died June 14 in Lakeland. Services were held June 19 at the Schrader Funeral Home with the Rev. Russell M. Fuller officiating.

Mr. Cardinal owned and operated several Sunoco service stations in the Wayne and Salem township areas. He was a former resident of Wayne. Mr. Cardinal was a resident of Plymouth for 22 years and moved to Florida in 1986. He was a member of the Greater Detroit U of M Boosters Club and he served in the U.S. Army Air Corps during World War II.

Survivors include: wife Ruth, of Lakeland, FL; son Jeffrey, of Mason; daughter Debra Covington, of Canton; brother Courtney, of Cheboygan; and four grandchildren.

Burial was in Oakland Hills Memorial Gardens in Novi.

Memorial contributions may be given to: National Ataxia Foundation, 600 Twelve Oaks Center, 15500 Wayzata Boulevard, Wayzata, MN 55391.

Barbero, of Plymouth

Anna P. Barbero, 77, of Plymouth, died June 8 in Livonia. Services were held June 12 at St. Thomas A' Becket Catholic Church with the Rev. Fr. Ernest M. Porcari officiating.

Mrs. Barbero came to the Plymouth community in 1977 from California. She attended St. Thomas A' Becket Catholic Church.

Survivors include: sons Louis J., of Plymouth, Joseph R., of Plymouth; daughter Josephine D. Guzzo, of Canton; brother Pete Cafareli, of Denver; and four grandchildren.

Local arrangements by Schrader Funeral Home.

Burial was in Riverside Cemetery in Plymouth.

Memorial contributions may be given to St. Thomas A' Becket Catholic Church or in the form of mass offerings.

Riverside Cemetery MAUSOLEUM



OTHER
CRYPTS & NICHES
ALSO AVAILABLE

SPECIAL FINANCING
AVAILABLE THROUGH
1st OF AMERICA BANK
PLYMOUTH, N.A.

NEW GARDEN CRYPT — FACILITY

20% OFF

SELECT CRYPTS THRU JUNE 30th

discounted during construction

FRITZ K. HOMANN AIA

FOR INFORMATION

CALL

453-7737

453-1234

660 PLYMOUTH RD.
JUST EAST OF THE HILLSIDE INN



Community Deaths

Bennett, of Tennessee

Donald Gerald Bennett, 66, of Sparta, TN, died June 3 in Sparta. Services were held June 6 at the Schrader Funeral Home with Pastor Headley Thweatt officiating.

Survivors include: son Donald, of Germany; daughters Debra Eisenlord, of Plymouth, Sharon Pinion, of Sparta, Donna Duke, of Sparta, Susan Dominowski, of Cheboygan, and Geri Lee Armonrot, of Vermont; brothers Rex and Robert, of Michigan; sisters Anna Kimberly, Agnus Lampher, and Edna Bechter, all of Michigan; 15 grandchildren; and two great grandchildren.

Memorial contributions may be made to the American Cancer Society. Burial was in Cadillac Memorial Gardens in Westland.

Davis, GM employe

Warner Davis, 80, of Canton, died June 18 in Ann Arbor. Services were held June 20 at the Schrader Funeral Home with Pastor Ray Miller officiating.

Mr. Davis was a machine operator at GM for 15 years. He retired in 1972. He came to the Canton community in 1952 from Tennessee. He was also a member of the Plymouth Church of Christ.

Survivors include: wife Myrtle, of Canton; daughters Jane Hawley, of Morrow, GA, Peggy J. Bogy, of Brooklyn, Alice Blackwood, of South Lyon; sons James L., of Canton, Bobby J., of Livonia, Billy H., of Westland; 12 grandchildren; and 14 great grandchildren.

Burial was in Knollwood Cemetery.

Memorial contributions may be made to the Michigan Cancer Foundation.

Williams, a homemaker

Marilyn F. Williams, 55, of Canton, died June 11 in Canton. Services were held June 14 at the Schrader Funeral Home with the Rev. Eugene Bragg officiating.

Mrs. Williams was a homemaker. She came to the Canton community in 1953 from Benton Harbor. She was a member of the Main Street Baptist Church of Plymouth.

Survivors include: husband Calvin, of Canton; son Robin, of San Jose; daughter Pamela Tompkins, of Canton; five grandchildren; step sisters Patricia Bullen, of St. Joseph, and Sally Morgan, of St. Joseph.

Burial was in Riverside Cemetery in Plymouth.

Barlow, long-time resident

Minnie Grace Barlow, 99, of Plymouth, died June 14 in Garden City. Services were held June 17 at the Schrader Funeral Home with Mr. David Thomas officiating.

Mrs. Barlow was a homemaker. She came to the Plymouth community in the late 1890s from Canada.

Survivors include: daughters Audrey Gibson, of Plymouth, Betty Delvo, of Englewood, FL; son Elmer, of St. Helen; five grandchildren; ten great grandchildren.

Burial was in Livonia Center Cemetery in Livonia.

Memorial contributions may be made to the Michigan Cancer Foundation or the Michigan Heart Association.



Ross B. Northrop & Son
FUNERAL DIRECTORS

Caring Since 1910

John B. Sussman - Ross B. Northrop, Jr.

Northville
1900 Northville Rd.
948-1234

Redford
22401 Grand River
331-0537

Clark, of Plymouth

Nellie M. Clark, 87, of Livonia, died June 6 in Westland. Services were held June 8 at the Schrader Funeral Home with the Rev. Fr. Robert S. Shank, Jr. officiating.

Mrs. Clark was a homemaker. She came to the Plymouth community in 1935 from Tennessee. She moved to Livonia in 1945 from Plymouth. She attended St. John's Episcopal Church.

Survivors include: daughter Onetta Plagens, of Livonia; sister Jessie Sanders, of Portageville, MO; four grandchildren; six great grandchildren.

Burial was in Riverside Cemetery in Plymouth.

Coley, auto inspector

Herschel F. Coley, 61, of Livonia, died June 16 in Livonia. Services were held June 19 at the Vermeulen Memorial Funeral Home in Westland with the Rev. Joseph Hickman officiating.

Mr. Coley was an automotive inspector.

Survivors include: wife Opal G., of Livonia; mother Lillian; son Herschel, of Pennsylvania, Tom, of Canton; daughters Belinda Talcott, of Canton, Cindy Knofski, of Westland, Reyna Wills, of Canton, and Karen James, of Canton; three brothers and four sisters; and 11 grandchildren.

Interment was in Oakland Hills Cemetery in Novi.

Erickson, of Florida

Dorothy Erickson, 67, of Stuart, FL, died June 7 in Stuart FL. Services were held in Stuart and will be held in Plymouth at a later date.

Mrs. Erickson was formerly of Plymouth. She was employed at the Plymouth State Home and at Skill Centers in Livonia and Garden City for the Developmentally Handicapped. She was a past-president of the Mayflower-Lt. Gamble Ladies Auxiliary 6695 Veterans of Foreign Wars.

Survivors include: daughters Nancy Kivlin, of Garden City, Vickie DeMarchi, of Jensen Beach, FL, and Cathy Sherwood, of Southgate; brother Robert Fuller, of St. Charles, IL; eight grandchildren; and two great-grandchildren.

Memorials may be made to the charity of your choice.

Whetstone, a homemaker

Mary E. Whetstone, 77, of Plymouth, died June 17 in Plymouth. Services were held June 20 at the Schrader Funeral Home with the Rev. Philip Rodgers Magee officiating.

Mrs. Whetstone was a homemaker. She came to the Plymouth community in the late 1970s from Detroit. She was a member of the First Presbyterian Church of Plymouth.

Survivors include: son Rex D., of Westland; cousin Russell Johnson, of Bedford, IN; and grandchildren Brian and Michael Whetstone.

Memorial contributions may be made to the American Cancer Society.



<p>ST. MICHAEL LUTHERAN CHURCH Sunday Worship 8:00 9:30 11:00 am Dynamic Youth Groups Ongoing Adult Education & Fellowship Regular New Member Classes Available Sport Programs & Community Outreach WE CARE ABOUT YOU SMALL GROUP MINISTRIES 7000 N. Sheldon Canton Township 459-3333 (Just South of Warren Road)</p>	<p>PLYMOUTH BAPTIST CHURCH 42021 Ann Arbor Trail, 453-5534 Sunday School 9:45 am Sunday Morning Worship Service 11:00 am Sunday Evening Service 6:00 pm Wednesday Night Family Night 7:30 pm Pastor William Barber, Jr. 928-2457 Bible Oriented Ministry</p>
<p>GENEVA PRESBYTERIAN CHURCH (USA) 5835 Sheldon Rd. Canton 459-0013 Worship Service & Preschool Care Sunday 10:00 a.m. Kenneth F. Gruebel Pastor</p>	<p>CALVARY BAPTIST CHURCH 43065 Joy Road, Canton 455-0022 David A. Hay Pastor Sunday School for All Ages 9:45 a.m. Sunday Services 11:00 a.m. & 6:00 p.m. Wednesday Bible Study & Clubs 7:00 p.m. Plymouth Christian Academy 459-3505</p>
	<p>RISEN CHRIST LUTHERAN CHURCH (Missouri Synod) 46210 Ann Arbor Rd. Plymouth (one mile west of Sheldon) 453-5252 Adult Instruction Course 9:30 a.m. Sunday Worship 8:30 a.m. & 10:00 a.m. Youth Group, Men's Club, Women's Ministry Small Group Bible Studies Rev. K. M. Mohr, Pastor Vacation Bible School July 10-14</p>

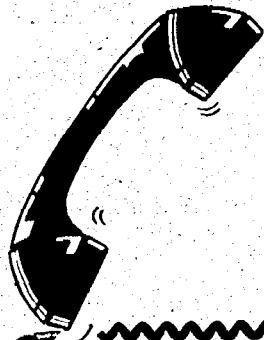

DIAL IT SHOPPING

These businesses and services are just a phone call away!

AUTOMOTIVE CARE

TOM'S CUSTOM AUTO & MARINE
 • Boat Repair & reconditioning
 • Fiberglass repair & painting
 • Prop repair
 • Boat trailers painted
Boat & Trailer Storage - Year 'Round
453-3639
 770 Davis - Old Village - Plymouth

BRICKWORK

D.W. BIDWELL MASONRY
 Quality work done for your home or business. Located in Plymouth.
451-1513
 Brick-Block-Concrete

CATHOLIC KINDERGARTEN

COME LITTLE CHILDREN
 45050 Warren Road
 Canton
 State certified educators for preschool, day care, latch key & kindergarten
 Wholesome & loving atmosphere ages 2½ through 12 yrs of age
455-4607

CEMENT & MASONRY

E. MORGAN HUMECKY CONTRACTING, INC.
 8787 Chubb Rd., Northville
 348-0066 532-1302
 Repairs • Residends • Commercial Porches • Patios • Driveways
 Floorings • Garage Floors • Etcetera
 Licensed • Insured • Free Estimates

CHILD CARE/PRE SCHOOL

HUGS & KISSES CHILD CARE & LEARNING CENTER, INC.
 249 S. Main
 Plymouth 459-5830
LOVING CHILD CARE PRE-SCHOOL KINDERGARTEN SUMMER DAY CAMP
 Ages 2½ to 8 • Open 7am to 6pm
 Full and Half Days • Small Classes
 Affectionate Qualified Teachers

CONCRETE DELIVERY

Concrete To Go
 Large Jobs, Small Jobs -- All Jobs
 7 Days Delivery
 (same rate for Sat. & Sun.)
 Metered Dispenser
 (pay only for what you need)
Canton Rental
 Concrete Tools Rented
 6438 Canton Center Rd
455-0844

CONSTRUCTION

JAMES DUNN Construction Inc.
 All types of home improvements and remodeling, big & small
 Specializing in additions
 • sun rooms • decks
 • siding • roofs
 Call for a free estimate
455-6384
 licensed and insured

DANCE

JOANNE'S DANCE EXTENSION
 9282 General Drive, Suite 180
 in the Plymouth Trade Center
455-4330
 Ballet — Tap — Jazz — Pre School
 Gymnastics — Fitness
 Baton — Cheerleading
 Professional and Certified Instructors

DRIVING SCHOOL

MODERN SCHOOL OF DRIVING
 29200 Vassar
 Livonia
476-3222 326-0620
 State approved teen classes starting monthly at Plymouth Cultural Center
 Private adult lessons available

ELECTRICAL

KEETH • HEATING • COOLING • ELECTRICAL
ONE CALL FOR ALL
453-3000
 400 N. MAIN PLYMOUTH
 Why not the best?
LENNOX PULSE
 Free estimates
 Licensed/insured Since 1951
 VISA MASTER CARD

FURNITURE REFINISHING

"Preserving Our Heritage"
PLYMOUTH FURNITURE REFINISHING
 331 North Main
 Call Jay Densmore
453-2133
 • Refinish & Repair
 • Hand Stripping
 • Antique Restoration
 • Antique Reproductions
 • Buy-Sell Antiques

HOME IMPROVEMENT

KITCHENS
 • Cabinets • Counter Tops
 • Vanities • Additions
 • Rec. Rooms • Siding
 • Windows • Doors • Enclosures
 • Decks • Baths • Awnings
MAYFLOWER KITCHENS
 454-1755
 Licensed Builder • Free Estimates

HOME MARKETING

Call Your Home Selling Team,
LEE & NOEL BITTINGER
 For ALL Your Real Estate Needs
 COLDWELL BANKER
 Bus: 488-8888
 Res: 488-8818

INSULATION

AIR TITE INSULATION
 882 N. Holbrook
 Plymouth 453-0250
 Save on the cost of heating/cooling
 Fast Professional Installation
 Blow — Blanket — Spray On
 "Your comfort is our business"
 Since 1980

KITCHENS

RAY R. STELLA CONTRACTING, INC.
 747 S. Main Plymouth
459-7111
 Let us create a room that will truly reflect your taste and lifestyle and we'll allow you to work with ease and convenience.
 Full Planning • Free Estimates

LANDSCAPING

Frank's Landscaping & Design Inc.
 44920 Ford Rd. • Canton
 • Mowing & Edging • Aeration • Sodding • Power Raking • Dethatching & Rototilling • Retaining Walls • Patios
 • Decks • Cement & Brick Driveway & Walkways • Sprinkler Systems
 Installed & Repaired • Tree & Shrub Planting
 Call for **459-7886** Mon-Sat
 9 AM - 6 PM
 Licensed & Insured
 Commercial & Residential Established 1977

LAWN MAINTENANCE

STULTS & SONS LAWN CARE
 5736 Tower Rd., Plymouth
 Commercial & Residential
 • Mowing & Edging
 • Spring Clean Up
 • Fall Clean Up
 • Shrub Trimming
 • Snow Plowing & Salt
 Ask for Lee Roy 453-1649 or 349-4330

LAWN SPRAYING

PLYMOUTH LAWN SPRAYING
 Established 1972
 Fertilizer
 Granular or Liquid
 Fungus • Weed
 Crabgrass Control
 Aerial • Insect Control
 165 W. Pearl
 Plymouth 455-7358

PLUMBING

ENGLAND PLUMBING & SEWER SERVICE INC.
 41801 Wilcox, Plymouth
455-7474
 Water Heaters • Plumbing Repairs • Modernization
 Sewer Basin Cleaning
 Garbage Disposals
 Emergency Services • Plaster Replacement
 Frozen Pipes Thawed

REAL ESTATE

Buying or Selling?
 Contact Your Home Marketing Expert
JUDY RUMPEL
 For A Professional Home Market Analysis
 218 S. Main Plymouth 48170
OFFICE 483-8888
HOME: 488-8782
 Schaeffer Road & State, Inc.
 Better Homes and Gardens

SEWER CLEANING

PUCKETT CO., INC.
 412 Starkweather
 Plymouth
453-0400
 Sewer Cleaning • Plumbing
 Heating • Air Conditioning
 Visa • Master Charge
 Night & Day Service
 Licensed • All Areas

TRAVEL

World Travel Inc. PMC CENTER
 42183 Ann Arbor Rd.
459-8753
 Hours: No Charge
 9 AM - 6 PM For Our
 Sat. 10 AM - 2 PM Services

TURF CARE

WAGENSCHUTZ LAWN SPRAYING
THE LAWN SPECIALISTS
 898 S. Main Street
 Plymouth 453-1576
 • Fertilizer - Granular or Liquid
 • Crabgrass & Weed Control
 • Fungus & Insect Control
 • Aerial • Seeding
 Early Bird Special — 10% Discount

WEIGHT CONTROL

WANTED: 100 People We'll Pay You To Lose Up To 25 Pounds In The Next 30 Days!
 Doctor Recommended
 100% Natural - No Drugs
WEIGHT LOSS CONSULTANTS
 598 N. MRI Street
 Plymouth - Old Village
 Donna 453-7802 Bea 453-2970
 or 427-2877 Dean 453-7359

WINDOWS

WESTON WINDOW REPLACEMENT
 595 Forest, Suite 78
 Plymouth 459-7835
 WE'll A the finest quality replacement windows and doors. Supply, free estimates and details of work. Energy efficient vinyl windows and ANGE RITE windows

AIR CONDITIONING

PUCKETT CO., INC.
 412 Starkweather
 Plymouth, MI
453-0400
 • Air Conditioning • Heating • Plumbing
 • Sewer Cleaning • Visa • Master Charge
 Night & Day • Licensed • All Areas



Getting down to business

PG. 29 THE COMMUNITY CRIB: June 25, 1989

For furry friends...

BY ROBIN LAKE

One thing that sets Feed Rite pet supplies apart from other pet stores is the commitment made by the owners, brothers Faris and Jim Samaan, to animal rights causes.

The Samaans said they are planning to donate a dollar on every bag of dog food sold to an anti-cruelty society in Detroit.

Feed Rite also carries a full line of pet supplies, in addition to tropical fish, birds, hamsters, and other small animals.

"We have everything under the sun," said Jim Samaan. "Everything you could possibly need."

The store sells large quantities of bulk food, supplies for all kinds of pets, including horses, as well as a few somewhat "oddball" items such as dog life jackets and designer clothes.

Feed Rite, which recently opened in Canton, is the third store the Samaans have opened. The first store opened downriver, in Lincoln Park, which is mainly a pet store. The second opened about two years ago in Dearborn Heights, which is mainly feed.

"The Canton store is a combination of the other two stores. We have both

pets and feed," said Jim. "It's working out really well and we're getting a good response."

Feed Rite also plans to set up some kind of club or special deal with wild bird feed due to the increase in popularity in the hobby of bird-watching.

"That's real big right now," said Jim.

Feed Rite is located at the northwest corner of Ford Road and Lilley.

Oldford honored

Larry Oldford, of Plymouth, a local agent for Farm Bureau Insurance, has earned three company awards for his excellent record of sales and service during the past year.

Oldford received the 1989 All-American Award, the 1989 Executives Club Award, and the 1989 Seal of Excellence, recognizing him as one of the top agents in the state.



Farm Bureau Insurance, one of the state's major insurers, has a statewide force of 400 agents serving over 100,000 Michigan policyholders.



Jim Samaan, and a friend, show off some of what makes Feed Rite, in Canton, so special. (Crier photo by Chris Farina)

Grand Memorial Gardens

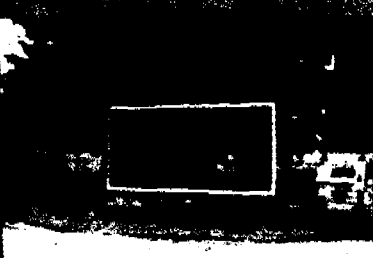
Where memory lives in life...

What My Family Should Know

An Executor/Survivor's Guide

Did You Know That There Are 87 Important Decisions That Must Be Made At A Very Critical Time

Don't leave your loved ones confused, plan for your future. The main purpose of this booklet is to show you how to benefit by gathering information.



By making these important decisions now you can minimize the emotional strain placed on your loved one.



This is a Lifetime Opportunity
A \$5.00 Value Yours FREE
Call 662-8982

It is better to know the burial options and facts now than to be without knowledge when needed.

A PLANNING GUIDE, BROCHURE AND INFORMATION WILL BE MAILED TO YOU WITHOUT COST OR OBLIGATION.



6729 Canton Center Road
Canton, Michigan 48187
(313) 459-4400

SELF-STORAGE
BUSINESS
&
PERSONAL

LOWEST PRICES IN TOWN

NATIONAL MINI STORAGE
THE SELF-STORAGE SPECIALIST

We Offer You:

- Low cost, secure storage space
- A wide range of unit sizes
- On-site manager
- Month-to-month leases
- Storage supplies
- Privacy
- Convenience
- Confidence

OFFICE HOURS
MON.-SAT. 9 a.m.-5 p.m.
SUN. 10 a.m.-3 p.m.
GATE HOURS
MON.-SUN. 7 a.m.-8 p.m.
(313) 459-4400
6729 CANTON CENTER ROAD
CANTON, MICHIGAN 48187

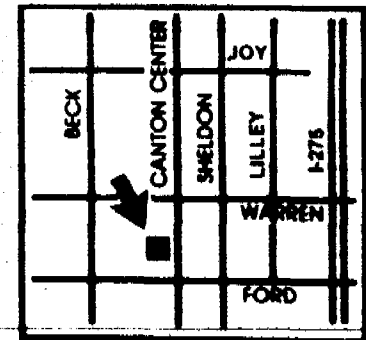

One of the lucky ones

Continued from pg. 6

skiing.

"You became different," he said, describing an attitude change made by many men as "survival mentalities."

He continued, "You have to smell Vietnam. It's a special smell. I don't have flashbacks but every now and then I catch a hint of that smell and it



Rick DiVeto, left, and a friend relax for the camera in South Vietnam.

brings out memories."

When Schrader eventually returned home no one was at the airport to greet him (his parents had not received the telegram). While there he was approached by a woman wanting him to get her a taxi. Later on during a motorcycle trip he carried a knife strapped to his leg while he slept.

"I think that in general the psychology is played up too much," Schrader said. "Everybody was affected by it...I'm simply one of the lucky guys. People need to understand I'm proud of what I did. To me I had to carry out valid orders.

"I didn't lose anything," he added. "I have the utmost respect for the families that have suffered that loss."

DiVeto, 44, joined the U.S. Air Force and spent most of his time in Vietnam working out of a major air base near Danang.

"When we first flew in, the pilot had to pull up and circle for 15 minutes because we were being shot at," DiVeto said. "Still Danang was one of the more secure bases." But the base was shelled and attacked repeatedly. One night DiVeto could hear the bullets whistling by as he scrambled off the flight line.

DiVeto, who still lives in Plymouth, remembers living out of a 12-man tent in Vietnam that he and his friends soon transformed into a solid structure made of wood. While there DiVeto also made his own desk and chair. "We all just improvised a lot," he said.

Please see pg. 34



KOREAN

MORRIS BEASLEY

U.S. Army, Dr. Data 1st Class

Put Your Company On The Road To Success.

The I-275/M-14 corridor. One of the fastest growing power centers for business in the state.

When it comes to leasing, buying or selling commercial property, the Patrician Group is the best one to steer you through the I-275/M-14 corridor.

As part of this dynamic community for years, we know the properties. We know the players.

Call us to find out how we can help your company on the fastest road to success.



P THE PATRICIAN GROUP, INC.

40000 Ann Arbor Road - Suite 103
Plymouth, MI 48170
(313) 499-9111

EXPANDING IN THE SURROUNDING AREAS

"We are working to keep this
The Best Community"

WATCH FOR THE OUR LADY OF GOOD COUNSEL
YOUTH GROUP FLOAT
IN THE 4th OF JULY PARADE

SPONSORED BY
THE PATRICIAN GROUP



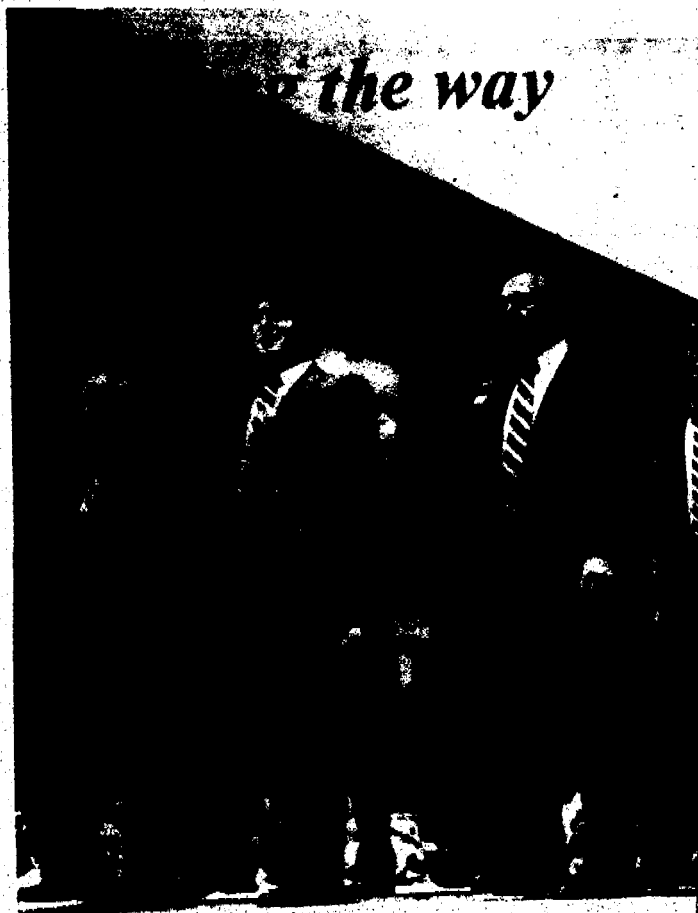

BILL OLSON

Active Civitan Olson dies

A noted Plymouth resident, who was very involved in civic affairs in The Plymouth-Canton Community died on Monday.

Willard G. "Bill" Olson, 62, of Plymouth, will be remembered for his civic involvement in Plymouth-Canton and as a veteran of World War II.

Olson retired from Olson Heating in 1988 where he was employed for more than 20 years as a furnace repairman.

He had served with the U.S. Army - 27th Infantry Regiment - in World War II, fighting in the South Pacific. An active veteran, Olson was a member of the Northville Veterans of Foreign Wars (VFW) Post. He was the post commander of Novi Legion Post No. 19 at the time of this death.

Active in community affairs, Olson was a member and past president of the Plymouth-Canton Civitan Club. He also was the recipient of numerous community service awards, including a Civitan Honor Key and an award for his deep involvement with the Special Olympics games.

Olson is survived by his wife Loretta, of Plymouth; his son Roger, of Brighton; and his daughters Kathleen Sarten, of Plymouth, Karen Parsons, of Sarasota FL, and Rebecca Dornoff, of Traverse City; four sisters; three brothers; and 11 grandchildren.

Services will be held today (June 28) at the Schrader Funeral Home at 8 p.m. with the Rev. Donald Lichtenfeld officiating.

Beasley

Continued from pg. 10

for infiltrating behind American lines.

Beasley wrote: "As I sit on our truck writing this letter, we can hear their bullets whizzing by us. But if it gets too bad we will move our truck."

Beasley's parents, both of whom are still alive, think their son may have given the letters to another soldier who sent them to the U.S. a little while later.

Beasley was awarded a Purple Heart and Bronze Star posthumously and promoted to private first class in 1953.

According to Marion Beasley, a friend of his brother's, Charles Wicks, witnessed the attack from a nearby hill, and feared the worst for his soldiering companion.

"I don't really dwell on it anymore. You just live with it every day," said Marion Beasley. "At the time I didn't follow the war much so I didn't know just how bad it was over there."

Tyburski guilty

A Canton man accused of beating his wife to death and hiding her in a family freezer for three years was found guilty of second degree murder charges on Monday.

Leonard Tyburski, 45, was found guilty after a short deliberation by the jury Monday, following a week long trial in Detroit Recorder's Court in front of Judge Richard Hathaway.

Tyburski will be sentenced on July 13. He faces a possible sentence of life in prison.



WESTLAND CENTER

June 29 - July 2, Center Court

LIGHTS, CAMERA...ACTION!

Kermit the Frog, Miss Piggy and all of your favorite Muppet friends are here to show you how to "Play It Safe!"

Jim Henson's Muppets are bringing a Hollywood movie "Backlot" to your shopping center to show you and your friends how to stay safe in and around cars.

Take a ride through Muppet Studios, and through the magic of robotics. Kermit, Miss Piggy, Fozzie, Gonzo, Animal and a lovable cast of supporting characters will teach your children some important traffic safety lessons.

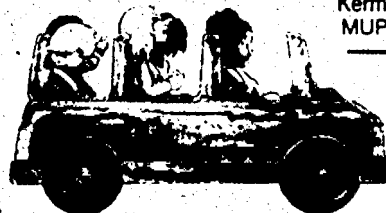

Plus there'll be lots of music, merriment... And maybe a surprise or two! So come "Play It Safe," with Kermit and the gang at Jim Henson's MUPPET TRAFFIC SAFETY SHOW!

"Play It Safe" is supported by the National Fraternal Order of Police, the National Parent Teacher Association, the National Safety Town Center, and the U.S. Department of Transportation's National Highway Traffic Safety Administration. "Play It Safe" is sponsored by The Plymouth Division of Chrysler Motors.

RECOMMENDED FOR YOUNG CHILDREN

WESTLAND CENTER

Open Daily 10 - 9, Sundays 12 - 5 Wayne & Warren Roads, Westland
Managed by The Center Companies

IN ASSOCIATION WITH: LIVONIA CHRYSLER PLYMOUTH

HONORING OUR FALLEN HEROES (AND ALL THOSE WHO SERVED) FROM PLYMOUTH-CANTON

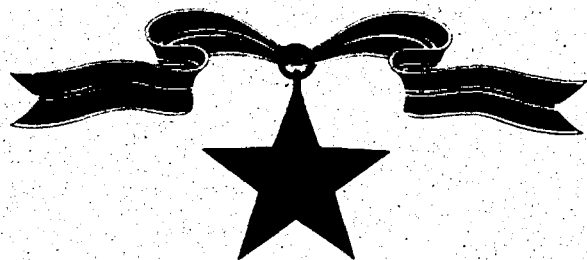

KOREAN AND VIETNAM VETERANS MEMORIAL DEDICATION

JULY 4th
11 A.M. - 12 P.M.
ROUND THE CLOCK VIGIL
3:00 P.M. JULY 3rd
till

Dedication July 4th
Corner of Ann Arbor Trail & Union
Next to Kellogg Park

KOREAN

MORRIS BEASLEY
U.S. Army-Private 1st Class

VIETNAM

HARRY E. BAKER, JR.
U.S. Army-Specialist 4th Class

JAMES PATRICK ECKLES
U.S. Army-Corporal

JAMES THOMAS FIELDS
U.S. Army-Specialist 4th Class

RICHARD ALLEN LARRICK
U.S. Army-Corporal

RICHARD LOREN NOWRY
U.S. Marines-Lance Corporal

HUGH HENRY SARAH
U.S. Army-Corporal

HARRY FRANKLIN ZALESNY, JR.
U.S. Army Chief Warrant Officer

This page is sponsored by the Adistra Corporation

CELEBRATING OUR 31st YEAR



ADISTRA

Adistra Corporation • 101 Union Street • Plymouth 48170 • 313/425-2999

REMODELING AND RESTORATION



THE OLD HOUSE CO

Jerry Gutowski
455-6089

Award Winning
Design



COMMITTED TO COMMUNITY & COMMUNICATIONS

(313) 453-6860



The Meadows
CONDOMINIUMS OF PLYMOUTH

Live In Downtown Plymouth

The Meadows. Luxury condominiums built with a commitment to quality. Elegant. Secure. All the amenities. And only 3 blocks from Plymouth's famous shopping and festivals.

Priced from \$162,900

2 bedroom, 2 bath, 1,600+ sq. ft. • Underground parking • Monitored security system • All appliances • Fireplaces • Open Noon - 5 p.m. Sat. & Sun. or call for a private showing.

(313) 453-3939

Builder's cooperation advised. Developer reserves the right to make changes in price, materials, and specifications without notice or obligation.

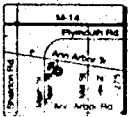

K.C. Colonial Real Estate
851 S. Main St. • Plymouth, MI

Unforgettable experiences

Continued from pg. 31

He continued: "Every day was a new experience, different. What it would be you didn't know.

"I'll never forget it."

Besides some trading on the sly with Marines and fighting off the hot humid weather and constant rain, DiVeto said his time in Vietnam was fairly routine. He also said that there were "loyal Vietnamese" who watched out for the Americans now and then.

He described one visit to a Danang bar when the owner rushed over to warn them.

"We went out the back of the bar as they (the Vietcong) were coming in the front," he said.

"Basically I enjoyed most of the service," he said. "A group of 12 of us went together. We all volunteered around the same time and we all made it back."

In 1974, Mansfield and Hyland bought Heide's in Plymouth. Today they share the business. But they also share the experience of fighting in Vietnam.

Hyland, 41, was drafted in 1967 and served with the 101st Airborne in Quang Tri Province fighting mostly North Vietnamese regulars. Mansfield served with a supply unit in the Mekong Delta and around Saigon from 1965-67. He was drafted out of college at Ferris State.

Hyland was wounded in an ambush on Easter Sunday, 1968, after spending

only four months in country. He lost a lung from the wounds.

"It was hot, scary," he said of Vietnam. "Being a kid at the time, I was only 18 - it woke you up. It brought reality quick.

"They prepared you as best they could," he added. "When you got off the plane and smelled the country, it was like nothing you've ever experienced."

Mansfield, 44, went to Vietnam on a troop ship which took 28 days from the U.S. He said he noticed the unique smell later on.

"The first thing I saw when we got off the boat were Shell and Mobil oil signs," Mansfield said. "It was one of the reasons we were there."

Mansfield said he drove the dangerous Route 1 near Saigon and remembers being ambushed by Vietcong and awaiting rescue from an Air Cavalry unit.

"They'd ambush anybody at any time," he said of the enemy, mostly VC guerrillas surrounding Saigon. "They'd service you during the day and you'd fight the same people at night."

Hyland spent six months in a hospital and was "gradually brought back to the world," while Mansfield said he left the jungles of Vietnam and flew straight home, getting little chance to prepare for what awaited him.

Like the way many soldiers went to Vietnam - that is, unprepared - they returned. And though changed by war, they have made some kind of peace with themselves and rejoined society.

"PICNIC TIME"
at Clyde Smith & Son Farm Market
"Open 4th of July 8-5"

WHOLE ICE COLD WATERMELON
\$2.99 & up



KENTUCKY VINE RIPENED TOMATOES
"Home grown flavor"
99¢ a lb.

IDAHO POTATOES
10 lb. bag
\$1.98

FRESHLY MADE FRUIT SALADS
\$1.99 lb.

SUPER SWEET SWEET CORN

CLYDE SMITH & SONS

Joanne's Dance Extension



NOW ACCEPTING SUMMER REGISTRATION

Classes begin the week of
June 26

Ballet
Tap
Jazz

Pre-school
Gymnastics
(including all equipment)

Phone 455-4330

9282 General Dr. Suite 180, Plymouth

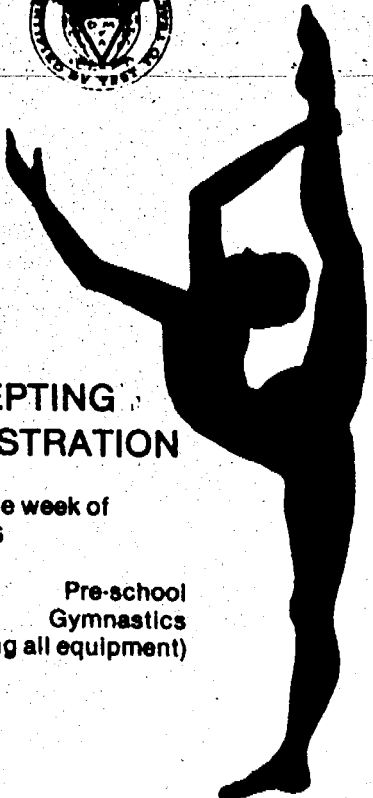

Zalesny

Continued from pg. 9

The letter also reads... "we learned to admire and love Harry, as deeply as we could have loved any brother." He was both valourous and unselfish, they said.

Zalesny was posthumously awarded the Distinguished Flying Cross, the Bronze Star Medal, the Air Medal with Oak Leaf Cluster and the Purple Heart. He also received a variety of campaign medals and honors from the Republic of Vietnam (South Vietnam).

The news of Butch's death was received at the Zalesny home on Dec. 26, 1969, the day after Christmas. Don Zalesny remembers it as "a bumper Christmas. It was just a real shock."

Donald still has the official letter sent to his parents announcing his brother's death. The second page of the type written letter was torn in agony by Margaret Zalesny.

Zalesny was buried with full military honors, including a flyover by fighter jets, at St. Hedwig's Cemetery.

"Butch was a great pilot," Donald said. "I'm more proud of him than ever. Yes, there's anger and sadness. For years I couldn't even talk about it. It's easier now."

Nowry

Continued from pg. 9

so write soon, take care and I'll see you in 105 days."

But Nowry never made it home. After leaving Hue he went up to Khe Sanh where the Vietnamese were waging a siege around the Marine base.

As a member of the 1st Motor Transport Battalion, 1st Marine Division, it was Nowry's job to keep the supply lines open at Khe Sanh.

On the morning of June 9, 1968, Nowry was on a much needed resupply mission outside of Khe Sanh. When the two-ton truck he was driving was hit by the enemy with a satchel charge, Nowry was killed instantly along with the other soldiers in the truck.

James Davis, a U.S. Marine captain, wrote the Nowrys about their son: "He was a person I could always depend on to do anything that had to be done and he proved that he was a truly trustworthy man... It is difficult for me to express the emptiness felt by the rest of us in the company over the death of your son."

"I don't feel bitter about it. You'd have bitterness if you didn't have God," said Mary Nowry. "It takes a long time to get over it, but you never forget it."

Rick Nowry was laid to rest in Livonia after a ceremony at the Church of the Nazarene in Plymouth. Today he is not forgotten, said Ken Nowry, who recently found a plastic bag at his son's grave site which included a picture, a medal and a "code of conduct" card.

"I'll go over there and still find flowers and other stuff," he said. "One of his old girl friends still calls us every Christmas."

And his memory is kept alive in the living room at the Nowry house on Joy Road, where an enclosed glass case holds a picture of the handsome young man in full uniform, along with his medals and a U.S. flag.



HERITAGE BANKCORP **HB**

A newly formed holding company for
HERITAGE FEDERAL SAVINGS BANK
Taylor, Michigan

1,860,000 SHARES
OF COMMON STOCK
ARE BEING OFFERED
AT A MAXIMUM
SUBSCRIPTION PRICE
OF \$11.50 PER SHARE.

For more information call:
STOCK CONVERSION CENTER
Detroit Metro: (313) 282-8080
Collect Calls Accepted
Toll Free Michigan: 1-800-662-5236
or
Capital Resources, Inc.
Washington, DC
(202) 331-9410

This announcement is neither an offer to sell nor a solicitation of an offer to buy securities. The offering can be made only by the prospectus, copies of which may be obtained by contacting Heritage Federal Savings Bank.

Eckles, fought with 1st Cavalry

Continued from pg. 7

brother meant you had "someone to help you get into trouble."

"And out," said Sally Eckles.

As they grew up the Eckles twins learned "twin tricks," switching classes on their teachers (in both high school and college). A few girls were also victims of this subterfuge now and then.

One memorable incident was during a banana split eating contest at Daly's Restaurant on Plymouth's Main Street. The brothers shared eating duties without anyone catching on. They, of course, won the contest.

"I think both of us were real jokesters," said Mike Eckles. "I remember all the silly, fun teenage things we did."

"One thing I always remember is the humor and games," said Karry.

As for more serious competition the brothers were into drag racing. Car fanciers since they were younger, Pat owned a '67 Charger and Mike a Plymouth GTX. They would drag race along Schoolcraft Road, Woodward Avenue and Telegraph Road.

In their free time they also liked to go fishing and deer hunting.

Both brothers were average or better students. "Pat didn't have to study as much. I had to work at it a little harder," said Mike.

They were also very popular. "Anyone I didn't know, he'd know," Mike said. "I don't know if that makes us popular."

Pat met Denise Econom, a neighbor while in junior high school. Although three years separated them they dated throughout Pat's high school days, going to the Penn Theatre, skiing, or to drag races in Detroit and at Milan Speedway.

Denise said one of the patterns of the

day was to also hang around at A & W's or Daly's and cruise around town and up to Northville.

While in high school the Eckles twins hung around with both Dick Larrick and James Fields, two local lads who were to die in Vietnam.

Graduating from Plymouth High School in 1966 the brothers attended college at both Schoolcraft College and Ferris State for a while. Pat worked with an elevator construction company and hoped to become an electrician. Later Pat was working for the Ford Motor Company when he was drafted by the U.S. Army.

"I knew he had to go," said Sally Eckles. "That's just the way life is." She remembers being upset especially because Pat had double vision.

After being called up Pat and Denise decided to get engaged and married. "We didn't talk about it (being drafted) much. It was obvious he wasn't happy about it," she said. "He had a good job."

In February of 1969 the couple wed. It was a quiet ceremony at the Church of Christ in Plymouth. Denise's grandfather Vernon Magee performed the service.

Not long after that Pat Eckles was shipped to South Vietnam.

"My feelings haven't changed," said Denise. "It's easy to look back and say this is what he should have done or that he should have done that. But you can't go back and change what he had to do."

Pat Eckles was not returned at a war and people forget why they fight and died."

Mike Eckles beat the draft board and enlisted in the U.S. Navy shortly after his brother's death in 1969, while Pat's wife Denise gave birth to a young baby girl, Candi.

Before Mike went into the Navy his



Denise Murphy, of Canton, shows some of her late husband's medals.

brother sent him a letter from Vietnam.

Eckles wrote: "I'm over here now and can't see any reason why you should have to come here too. While I'm over here, they won't send you over. So if you're smart you will

stay over here. And if you don't go to the front you'll be a deserter and that's something that I don't want you to do."

Pat Eckles was not returned at a war and people forget why they fight and died."

"...the only reason that I suggested this is that one of us is already here and there is no reason for both of (us) over here. Also if you did come over here, we could be together. Because they let twins be together and right now I'm in a gettin' over platoon."

After expressing concern for his brother, Pat asks about his car: "Have they sold my 'Charger' yet?...I'm kind of curious about what's happening with it."

In a letter dated three weeks later (July 26, 1969) Eckles again writes his brother asking for a response to his previous letter:

"I have to I'll extend over here just to keep you from coming over, and I'll tell you right now it's nothing but hell. I know you wouldn't like the idea of somebody shooting at you any more than I like it here."

"But I see no use for both of us getting shot at when it could be just me....I live day by day waiting for the day that I can meet Denise in Hawaii and when I can come home."



Public notices

CHARTER TOWNSHIP OF CANTON NOTICE OF PUBLIC HEARING

NOTICE IS HEREBY GIVEN THAT A PUBLIC MEETING WILL BE HELD ON TUESDAY, JULY 11, 1969, AT 7:00 P.M. AT 1150 S. CANTON CENTER ROAD BY THE TOWNSHIP BOARD OF TRUSTEES OF THE CHARTER TOWNSHIP OF CANTON TO CONSIDER A REQUEST FOR THE FOLLOWING SPECIAL LAND USE AS PROVIDED FOR IN SECTION 5.14E. OF THE CANTON TOWNSHIP ZONING ORDINANCE.

THIS REQUEST IS FOR CONSTRUCTION OF ORCHARD RIDGE ESTATES CONDOMINIUM TO BE LOCATED ON THE WEST SIDE OF RIDGE ROAD BETWEEN GYDE AND WARREN ROADS.

WRITTEN COMMENTS WILL BE RECEIVED UNTIL 7:00 P.M. AT 1150 S. CANTON CENTER ROAD. A PUBLIC HEARING ON THE SPECIAL LAND USE REQUEST MAY BE REQUESTED BY ANY PROPERTY OWNER OR THE OCCUPANT OF ANY STRUCTURE LOCATED WITHIN 300 FEET OF THE BOUNDARY OF THE PROPERTY BEING CONSIDERED FOR A SPECIAL LAND USE.

PUBLISH: THE CRIER: JUNE 28, 1969

LOREN N. BENNETT, CLERK

CHARTER TOWNSHIP OF CANTON NOTICE OF PUBLIC HEARING

NOTICE IS HEREBY GIVEN THAT A PUBLIC HEARING WILL BE HELD ON TUESDAY, JULY 11, 1969, AT 7:00 P.M. AT 1150 S. CANTON CENTER ROAD BY THE BOARD OF TRUSTEES OF THE CHARTER TOWNSHIP OF CANTON TO CONSIDER A REQUEST FOR THE FOLLOWING SPECIAL LAND USE AS PROVIDED FOR IN SECTION 5.14E. & 16.03 J. OF THE CANTON TOWNSHIP ZONING ORDINANCE.

CONSIDER REQUEST FOR SPECIAL LAND USE APPROVAL FOR AN AUTOMOBILE FILLING STATION TO BE LOCATED IN C-3, HIGHWAY ORIENTED COMMERCIAL DISTRICT.

WRITTEN COMMENTS WILL BE RECEIVED UNTIL 7:00 P.M. AT 1150 S. CANTON CENTER ROAD. A PUBLIC HEARING ON THE SPECIAL LAND USE REQUEST MAY BE REQUESTED BY ANY PROPERTY OWNER OR THE OCCUPANT OF ANY STRUCTURE LOCATED WITHIN 300 FEET OF THE BOUNDARY OF THE PROPERTY BEING CONSIDERED FOR A SPECIAL LAND USE.

PUBLISH: THE CRIER: JUNE 28, 1969

LOREN N. BENNETT, CLERK

CHARTER TOWNSHIP OF CANTON NOTICE OF PUBLIC HEARING

NOTICE IS HEREBY GIVEN THAT A PUBLIC HEARING WILL BE HELD ON TUESDAY, JULY 11, 1969, AT 7:00 P.M. AT 1150 S. CANTON CENTER ROAD BY THE BOARD OF TRUSTEES OF THE CHARTER TOWNSHIP OF CANTON TO CONSIDER A REQUEST FOR THE FOLLOWING SPECIAL LAND USE AS PROVIDED FOR IN SECTION 5.14E. OF THE CANTON TOWNSHIP ZONING ORDINANCE.

THE REQUEST IS FOR CONSTRUCTION OF CLUSTER SINGLE FAMILY DETACHED RESIDENTIAL (FOX RUN SUBDIVISION) PROPOSED TO BE LOCATED ON THE WEST SIDE OF BECK BETWEEN HANFORD AND FORD ROADS.

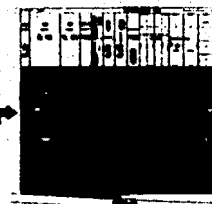

WRITTEN COMMENTS WILL BE RECEIVED UNTIL 7:00 P.M. AT 1150 S. CANTON CENTER ROAD. A PUBLIC HEARING ON THE SPECIAL LAND USE REQUEST MAY BE REQUESTED BY ANY PROPERTY OWNER OR THE OCCUPANT OF ANY STRUCTURE LOCATED WITHIN 300 FEET OF THE BOUNDARY OF THE PROPERTY BEING CONSIDERED FOR A SPECIAL LAND USE.

PUBLISH: THE CRIER: JUNE 28, 1969

LOREN N. BENNETT, CLERK

CHARTER TOWNSHIP OF CANTON NOTICE OF PUBLIC HEARING

NOTICE IS HEREBY GIVEN THAT A PUBLIC HEARING WILL BE HELD ON TUESDAY, JULY 11, 1969, AT 7:00 P.M. AT 1150 S. CANTON CENTER ROAD BY THE BOARD OF TRUSTEES OF THE CHARTER TOWNSHIP OF CANTON TO CONSIDER A REQUEST FOR THE FOLLOWING SPECIAL LAND USE AS PROVIDED FOR IN SECTION 5.14E. & 16.03 B. OF THE CANTON TOWNSHIP ZONING ORDINANCE.

CONSIDER REQUEST FOR SPECIAL LAND USE APPROVAL FOR A CHURCH PROPOSED TO BE LOCATED IN AN R-3, SINGLE FAMILY RESIDENTIAL DISTRICT.

WRITTEN COMMENTS WILL BE RECEIVED UNTIL 7:00 P.M. AT 1150 S. CANTON CENTER ROAD. A PUBLIC HEARING ON THE SPECIAL LAND USE REQUEST MAY BE REQUESTED BY ANY PROPERTY OWNER OR THE OCCUPANT OF ANY STRUCTURE LOCATED WITHIN 300 FEET OF THE BOUNDARY OF THE PROPERTY BEING CONSIDERED FOR A SPECIAL LAND USE.

PUBLISH: THE CRIER: JUNE 28, 1969

LOREN N. BENNETT, CLERK

A Directory to Plymouth and Canton's Professional Services

FUNERAL HOME

SCHRADER FUNERAL HOME, INC.

*The Schrader Family - Funeral
Directors in Plymouth for
over 85 years*

Personal, Professional Care
Pre-Arranged and Pre-Financed
Funerals

EDWIN A. SCHRADER

**EDWIN A.
SCHRADER, JR.**

280 S. Main • Plymouth
453-3333

ACCOUNTANT

MORRISON, STANWOOD & POLAK, P.C.

CERTIFIED
PUBLIC ACCOUNTANTS

453-0209

823 PENNIMAN AVE.,
PLYMOUTH,
MICHIGAN 48170

William J. Morrison, Jr.
Jean C. Stanwood
Stanley W. Polak

ATTORNEYS

JOHN F. VOS III

- Hospital Negligence
- Slip and Fall Injuries
- Bodily Injury Cases
- Social Security
- Auto Accident (No Fault)
- Injury From Defective Products
- Medical Malpractice
- Workers' Compensation

No Fee For
Initial Consultation

OVER 50 LAWYERS
SERVING YOU FOR 40 YEARS
455-4250 • 747 S. Main • Plymouth

DRAUGELIS ASHTON SCULLY HAYNES MACLEAN & POLLARD & DISTEFANO

AGGRESSIVE LEGAL
REPRESENTATION
SINCE 1960

PERSONAL INJURY
PROBATE
TRIAL PRACTICE
GENERAL PRACTICE

843 PENNIMAN • PLYMOUTH • 453-8844

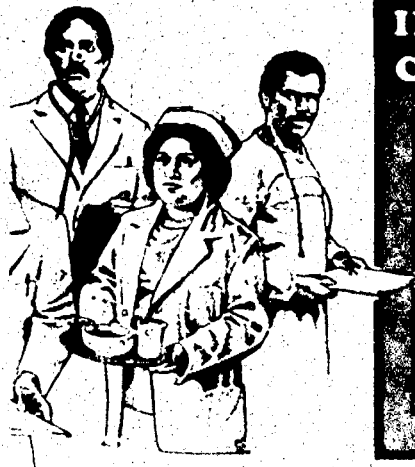

LICENSED INSURANCE COUNSELOR

**Bruce F. Mirto, CLU
&
Associates**
*Independent
& Objective
Insurance Analysis
& Design*

Since 1953
292 S. Main, Plymouth
453-8900

MEDICAL SPECIALISTS

OPHTHALMOLOGY

KEITH A. KOBET, M.D.

DIPLOMATE, AMERICAN BOARD
OF OPHTHALMOLOGY

- Cataract Implant & Laser Surgery
- Glaucoma • Myopia Surgery
- Free Shuttle Service for
Senior Citizens
- Participating with Medicare,
and

Most Health Plans
OFFICE HOURS BY APPOINTMENT
(313) 458-7858
Canton Professional Park
• 8510 Canton Center Rd.
Canton, MI 48187

DERMATOLOGIST

ARTHUR W. GULICK, M.D.

Diplomate, American Board
of Dermatology

*Diseases and Surgery
of the Skin*

Participating with Medicare,
Blue Cross, McAuley and Most
Health Insurance
459-3830

Saturday & Evening
Appointments Available
227 N. Sheldon Rd.
Plymouth, Michigan

HEALTH CARE

UNIVERSITY OF MICHIGAN M CARE HEALTH CENTER IN PLYMOUTH

*Family oriented primary
care health services provided
to all members of the family.*

INTERNAL MEDICINE
Harold Husovsky, M.D.

OB/GYN
Ingrid Nygaard, M.D.

PEDIATRICS
Stevn Koettl, M.D.
APPOINTMENTS INFORMATION
459-0820

9398 Lilley Rd., Plymouth

ST. MARY HOSPITAL

*"Serving the
Plymouth-Canton
Community
for over 25 years"*

36475 W. Five Mile
at Levan Road
Livonia

24-HOUR EMERGENCY
PHYSICIAN REFERRAL

Call 464-WELL

OAKWOOD CANTON HEALTH CENTER

Family Practice
Obstetrics & Gynecology
Specialty Physician Services
Rehabilitation Services
Industrial Medicine

24 HOUR EMERGENCY CARE
Emergencies 459-7036
General Information 459-7030
Obstetrics/Gynecology 459-0040
7300 CANTON CENTER RD., CANTON

**IF YOUR PRACTICE IS NOT
LISTED HERE, IT SHOULD BE!**

**CONTACT YOUR CRIER
AD CONSULTANT TODAY!**

453-6900



They're off!!!

The runners in the 11th Annual Canton Parks and Recreation Five Mile Run bolt forward on Saturday. The first place overall male was Barry Purse, of Onstead. Second place went to John Springer, of Redford. Gary Purse, of Onstead, finished third. Noelle Dixon,

of Livonia, was the first female finisher. Diane Gettscham, of Westland, was the second female overall, and Marianne Bayne, of Westland, was the third female finisher. (Crier photo by Robert Richards)

Racing away on cycles

BY ROBIN LAKE

Despite starting to ride cycles "late in life," John Durkin currently enjoys success as an amateur racing motorcyclist.

Durkin, who lives in Canton, has participated in three out of four local races in what is called production (or stock class) and placed first, second, and third in those races.

Durkin, who has been racing for about four seasons, first started riding a motorcycle eight years ago at age 21. He currently competes against a majority of 18-20 year-olds who are single and work for motorcycle shops where they can get both financial and parts assistance, said Durkin.

Right now Durkin is looking for his own sponsorship to help ease the

financial burden.

Durkin races locally through the West East Roadracers' Association (WERA) on street cycles in a closed circuit race track that includes rights, lefts, hills, and straightways. He has raced in the stock class D (up to 400 ccs), which means that internal work, such as modifications on the engine or added suspensions are not allowed.

"I like the stock class because it's more challenging," he said. "You rely more on the rider's ability."

Durkin said that motorcycle racing is still a relatively small sport with only about 20,000 licensed riders in the country, which is divided in regions for racing.

Please see pg. 39



JOHN DURKIN

Sports

Blohm named Canton coach

BY JANET ARMSTRONG

Bob Blohm has been named the new varsity girls basketball coach at Canton High School by Centennial Educational Park (CEP) Athletic Director Paul Cummings.

"Coach Blohm brings to the position many years of outstanding experience and success to the game of basketball," said Cummings.

Blohm replaces Rob Neu, who left at the end of the season to take a job in Traverse City.

Blohm was the varsity girls coach at Salem from 1979-1983, when he decided to take a break from the game. He was also the junior varsity boys coach at Salem from 1979-1982.

Most recently, Blohm was the Canton girls junior varsity coach under Neu.

Blohm, who also serves as Canton's athletic manager said he is in for a hectic schedule.

"I'm pleased with the opportunity," said Blohm. "But it's going to be a busy schedule."

According to Blohm, one of the main reasons he took the job was so that the team could continue with the programs both Neu and Blohm had set up four years ago.

"We wanted to maintain the continuity that we started," said Blohm. "And continue to march on."

Cummings said that Blohm has a good reputation, and is good for the game of basketball.

"He is highly respected for his knowledge of the game, and for his ability to work with young people," said Cummings.

Blohm said that Mike Shay and Leigh Langkable, who have helped out with the program for two years were staying on - Shay as junior varsity coach and Langkable will continue to coach the freshman team.

LAT E

If your printer's late, you're out of luck. To an American Speedy printer, the only good job is an on-time job, done when you need it, the way you need it. If your printer's on the wrong side of your deadlines, bring your printing job to us for timely work.



America's Real Printers.
1052 W. Ann Arbor Rd., Plymouth
455-2350 FAX 455-0686

Woodland Meadows
Recycling & Disposal Facility

Sanitary Landfill

Licensed by the State of Michigan

All loads must be covered.

Van Born Road,
west of Hannan
328-0883



A Waste Management Company

HOME ST.

New address?
WELCOME WAGON
can help you feel at home

Greening new neighbors is a tradition with WELCOME WAGON - America's neighborhood tradition.

It is nice to visit you. To say "hi" and present gifts and greetings from community-minded business. It is also present inviting you can return for more gifts. And it is all free.

A WELCOME WAGON visit is a special treat to help you get started and feeling more "at home." A friendly get together is easy to arrange. Just call me.

WELCOME WAGON

Call Myra
488-8754
(Plymouth Area)



Durkin glides his motorcycle through a turn. (Crier photo by Robert Richards)

Durkin races away

Continued from pg. 38

Durkin races in the north central region and has raced in Gratten Course, Grand Rapids, Indianapolis Raceway Park, and Blackhawk Farms in Illinois. The various regions throughout the country met in the Poconos (PA) during the weekend of June 24 for a national competition.

"I hope to do well, but I'll be racing on a different course and it's hard to know how everyone else will do," said Durkin.

Racing motorcycles requires

licensing through the WERA to make sure all the racers are safe. Two ambulances are present at each race and leather suits are worn for safety.

"It's not a rag tag group," Durkin said.

Off the racetrack, Durkin works as a service engineer with Instron, where he manufactures and tests materials. He is married and is the father of an eight month old baby.

"They're my pit crew," he said.

'Superstars' on tap

The Canton Parks and Recreation Department is sponsoring the 10th Annual "Youth Superstars" competition on Saturday, July 15 at 10 a.m.

Registration is at 9:30 on the same day and the competition is free.

"Superstars" test a variety of athletic skills including basketball, golf, soccer, baseball, running, and more.

The age divisions are nine and under, 10-12, and 13-15 for both boys and girls. Awards will be given out in each age group.

For more information call 397-5110.

Scramble golf results

Kevin Schuam, Paul Lapinski, and Gerald Allen took top honors in the Ninth Annual Canton Parks and Recreation Department's Father's Day "Scrambles" Golf Tournament recently.

With a score of 62 (10 under par), the pair scored a two-stroke victory over the second place team of T. J. Rivard, John Krueger, and B. W. Kennedy.

Also shooting a 64 was the team of

Keith Zamborski, Mark Morton, and Tom Brudinski.

The coed division was won by the team of Bob Dates, Linda Cummings, and Kristen Harrison with a 5-under total of 67.

Londrive honors went to Randy Hall and closest-to-the-pin was won by Gerald Allen.

Twenty-five teams took part in this year's tournament.

Seniors win gold medal

BY RITA DERBIN

The Canton Senior Sluggers are pure gold.

The Canton women's softball team swept a Colorado team three games to none in a best of five series to win the first gold medals awarded in softball at the U.S. National Senior Olympics held in St. Louis last weekend.

Leading the way in the Sluggers' 23-13, 14-8, and 20-10 victories were Jeanne Hyne, who batted .786 and Jerry Gawura, who batted .538 with 13 RBIs, two doubles, two triples and a

home run as Canton came from behind in all three games.

Gawura was also a member of the Sluggers' pitching staff which included Dottie Finforck and Kay Oswald.

"We were slow starters," said manager Louise Spigarelli. "But the ladies busted loose at the end of each game. That's why they're called the Sluggers."

The Sluggers will be participating in a tournament in Mt. Clemens this weekend.

Let's Get Growing

*10% off any shade tree with ad

- 40 acres of trees
- residential
- garden center
- commercial
- petting farm
- from design to installation



more than a nursery
— complete landscaping design

crimboli nursery, inc.

50145 ford road, canton

☎ 495-1700



REMODELING
Residential & Commercial

- Kitchens • Baths • Family Rooms •
- Recreation rooms • Wood Replacement
- Doorways • Brick • Block • Cement
- Work • Custom Bay Windows • Wood
- Window Replacements • Aluminum
- Storm Windows and Doors.

NO JOB TOO SMALL

C. CASE BUILDER

455-1320
Charles B. Case
Michael Lockwood

PG. 39 THE COMMUNITY CRIER: June 24, 1989

Is your mom  **BUGGING** you about spending your allowance?

Is it difficult to  **BEAR** the thought of not having enough cash?

Well, **STOP**  **HORSING** around and become a **CRIER CARRIER!**

Anyone interested can  **WING** it in no time!

It's an easy and fun way to earn

And we're not  **LION!**

The following is a list of available routes...

Rt. No.	GENERAL AREA
14	ROSS & SIMPSON
51	MANTON & MORRISON
51A	ROCKER & JUDSON
25	MILL & HOLBROOK AREA
27	PARKVIEW & RIVEROAKS AREA

Call 453-6900



The Community Crier

Park residents fight health problems

Continued from pg. 3

threat to residents," Swistak said.

A number of state and county health officials inspected the park on Friday, and have reviewed the report issued by Techna.

"The (Techna) report gave the park a pretty clean bill of health, and we concur with that conclusion," said John Schmidt, of the Wayne County Department of Public Health's Environmental Protection Bureau.

"The lots out there just have very poor drainage, which is probably due to the high amount of clay in the soil," he said.

Addenda & errata

Last week, The Crier misidentified a radio station that will broadcast during Plymouth's Fall Festival. WJR radio's mobile station will come to Plymouth on the Saturday of the fest.

Bruce Davis, assistant director of the Environmental Protection Bureau, also agreed with the findings of the report.

"We have found no contamination from the ground up. There is a black slippery matter on the surface, but we feel that it is an algae — a result of standing water," he said.

"If you've got clay (in the soil), you're going to hold water," he said.

Don Chudzinski, a resident of Sherwood Village and president of a tenant's organization in the park has said that the group will continue to withhold rent, until park officials tend to the drainage problem at the park.

"While the tests showed no contamination, there is still a health problem at the park — there is still very poor drainage, and standing water poses a health problem," he said.

Chudzinski filed a complaint with the Environmental Response Division of the Department of Natural Resources on June 5 about contaminated water and soil. Anthony Piitts, an environmental quality analyst with that office (located in Northville) responded in a letter dated June 22,

that no evidence of contamination was found.

Another letter, dated June 26, from John Caterino, of the Division of Environmental Health of the Michigan Department of Public Health, said that

McClendon

Continued from pg. 3

"That is a big job — and if it became too much to handle both positions, then I may consider resigning from the school board, but it's too early to say," he said.

McClendon was re-elected last year to another four year term — his seat will be up for grabs in a 1992 election.

When a school board member resigns, the board appoints a replacement until the next June school election. The election is then held to fill the remainder of the term.

Were McClendon to resign, the board would appoint a new member, and then hold an election for a two-year seat in 1990.

There are two four-year school board seats coming open in 1990. They are currently held by Marilyn Schwinn and Jeanette Wines.

the drainage at the park was also not a problem.

"We walked through the park and evaluated site drainage. No large areas of standing water were observed," the letter said.

"Some areas, between mobile home units, were somewhat wet with the ground soft and spongy. These conditions were attributed to the excessive rains of recent days and not to poor site drainage," it said.

Swistak said that a letter has been sent to all residents of Sherwood, informing them of concerns of residents, and of the results of the tests.

Memorial

Continued from pg. 3

names of those local soldiers who were killed — one wing for Korea and one for Vietnam.

Work on the monument area (near the Plymouth Rock memorial for veterans of other wars) is being completed this week by City of Plymouth DPW workers.

Crier Classifieds

Curiosities

HAPPY JULY 4th!

BARNEY WHITE: great time to be a lobbyist for the oil industry.

DELAUROS: congrats on the new baby Lydia!

RENIE LARSON will be older soon.

WELCOME LISA, BILL, Marilyn & Chuck Tuori from Virginia.

"I TAKE CREDIT as well as blame." — The Canton Philosopher

ONE THING ABOUT HILLS — you get over one and there are always others to have the fun of climbing." — Jeanne and Mike Greene (Jeanne should know — she's got another "hill" coming herself.)

"TOSTADOES in an oyster shell." — Mike Carne review of the Mayflower hors d'oeuvres

ANDREA — Thanks for a great tour of Plymouth. I'll return the favor next time you're in Florida, meanwhile, think of me the next time you go swinging. **GARY**

MARY! Do you really smoke those cigars?

ASTRID, how's work going? Do you miss not doing anything yet?

WHO SERVES on the Northville Chamber board? See page 138 in The Guide to Plymouth-Canton-Northville.

KITTY: Happy Birthday to the Fourth of July Baby! Just two more weeks until we're sitting in the California sun and watching the Giants and A's (Maybe Jose will be back!)

JOHNNY, I can't believe you ate all those Chicken McNuggets!

John & Merc, how was Met?

Merc, lunch was great! We'll have to do it again sometime!

EVEN SMALL ADS get attention... You're reading this aren't you? Call 463-9800 to place your ad today!

Curiosities

Friday is Monday, Monday is Tuesday, and Tuesday is Saturday?!

"The problem with returnable bottles is that they don't pay interest on them." — Charlie Yerkas, 1988.

TOM YACK didn't skip all the sessions in Washington, D.C.

THANKS for the shish-k-bobs! (and congratulations on the new car—except for the decal)

IF YOU HAD to pick a new middle name, **BEATRICE**, is a good one.

HEATHER MIRTO graduated! Congratulations!

JESSICA found the perfect card — the "art" of cigar smoking.

Tiny Winy — I'm sorry I've been so tired lately. This story is taking a lot out of me. Now, it's over! **G. Master**

The Crier salutes those who were killed in Vietnam and Korea!

Ron, take better care of that toe.

Congratulations **Fay** — best poodle skirt in town.

Happy 22nd Anniversary **BH** and **Mary Baxter**.

Larry is the best greaser in town.

Holly, Dave, Judy, Bob and **BH** smoked Camels (and choked)

Good to see **Mary B.** on the dance floor.

Margaret Slezak and **Sue McElroy** knew all the words to all the songs.

Tony Paciocco put the younger generation to shame — maybe **Adriano, Sam** and **Deen** could take lessons.

Happy 21st Birthday **Becky!**

Keep going **Deb**, maybe we'll find the living room yet.

Did you see all those poodles & sunglasses running around the Cultural Center Friday night?

Dizzy & Daffy are on the endangered species list at F.O.A.

Curiosities

Rain, rain go away!

How OLD is ED??

BETH, how was camp?

John — It's nice to see that you have your left arm back again.

Alan has just joined The Crier carrier team. He is taking over Route No. 137. Welcome aboard and good luck! **Verna**

Jan Munday doesn't want anyone to know that **Set** is her birthday, so don't read this circle. (Jan — this is for your eyes only — **HAPPY BIRTHDAY!**)

I want to congratulate **Ryan** from Route No. 187 and **Lisa** from 88 & 88A on a job well done. I'm proud you are on The Crier carrier team! **Verna**

Mom — Thanks for watching Big Foot I. I hope he was nice.

Taurus (April 20-May 20) Beware of over exercising as it could cause pain. Cancer figures prominently in your near future. Mystery enters your life, good things happen.

Everyone should have a "Field of Dreams."

Arlee (March 21-April 19) You have been seen with a man in velvet. Look to increased family togetherness. Someone may be visiting. Seek out taller people for guidance.

ED — I heard that you had to have your feet "wrapped" while you were in Washington. Was it due to an injury?

Cancer (June 21-July 22) Your time is nearing — look at it as gaining experience. Your present program is benefiting your, don't get off the track. Keep your chin up — clue in **Taurus**.

Kevin, what are you going to do with the Bride's Bouquet?

Terry actually went out in public with that shirt on. What's really bad is everyone voted him the best 50's dress-up at the dance.

Oreg, the caped crusader's back — get out the bermbobile!

Curiosities

Ask **Julle** about "The Joker."

Steve has joined The Crier team. He is taking over Route No. 41A. Welcome aboard and good luck! **Verna**

Beauregard is angry! He is going to city hall to find out why they built a well around the fire hydrant on Fleet Street.

COREY is doing double duty, he is taking over Routes No. 18 and 45. Welcome aboard and good luck! **Verna**

John has a very "sweet" way of saying "thank you!"

Quote from **Aunt Hazel**, "I'm fit as a fiddle!"

Whoever won the dance contest can be thankful that **J.** and **L.** left before the event. **L.** is so good she could even cover up for **J.** and still win.

Pam Redlow & **Brandis Hollingworth** are on **Sparky's** hit list.

Faye won twice Fri. night. You got the best dressed woman (50's girl) at the dance and she got to stand next to someone shorter than her. **Right Danny?**

For those who are wondering, **Sparky's** still doing just fine! Thank you

Anyone who missed the C of C 50's dance missed out on a great time.

Photography

RAWLINSON PHOTOGRAPHY
Specializing in Weddings and Family Portraits
463-8872

Child Care

Licensed day care in my Canton home. Reasonable rates, other children to play with ages 2 and up. 387-8881 after 6 p.m.

Bands

MyFynus
Great band for weddings and special events. Hear and see us in action. 463-2744

Crier Classifieds

PG. 41 THE COMMUNITY CRIER: June 21, 1989

Lessons

Evola Music
Now Open in Plymouth
Pianos, Organs, Keyboards
Bend Instruments and Accessories
Sheet Music and Books
S. Jos. Lessons and Services
215 Ann Arbor Rd., Plymouth
455-4877

ART LESSONS
All media, all ages, all FUN!!
Call today, 455-1222 The Art Store
Plymouth

PIANO, ORGAN & VOICE LESSONS IN YOUR HOME. DAN HILTZ. Bachelor of Music Degree & Bachelor of Science in Education 721-6135

Piano lessons for all ages, Plymouth, Michigan. 458-4717

Services

HORTON PLUMBING
Residential, commercial, new work, remodel and repair. Sewer and drain cleaning. Licensed and insured, 455-3332 or 453-7824.

DCH Carpentry. Licensed and Insured Builder. New construction, remodeling, custom oak trim and mantels. Dave Herriman. 459-9892.

Alterations, hems and repairs, some tailoring. 455-8988 or 455-7403

***ELECTRICIAN* SERVICE UPGRADE VIOLATIONS REMOVED DRYER AND A/C OUTLETS FREE ESTIMATES 422-0221**

LAMBERTO CONSTRUCTION All types of cement work. No job too big or too small. Free estimates. Licensed and insured. 465-2925

Have a lot of trash and want to get rid of it quick? We have 30 yd. dumpsters we will drop off on Friday night or Saturday morning, pick up Monday morning. Call for price. 453-5688. Contractors welcome.

TONY'S TREE SERVICE
Trimming, topping, removals and stumps. 25 years experience. Free estimates. 420-0680 or 420-0712.

Services

DAVIS DECORATING
Painting, Wallpapering and Removal
Over 25 yr's Exp.
Free Estimate Custom Work Insured
Call Jerry 459-8205

RENOVATIONS
Quality work at affordable prices. OLD HOUSE RESTORATIONS — DECKS — SUNROOMS & ADDITIONS. Rex G. Harvey, Licensed Builder. 455-1317

Do you need a handyman? Someone to hang wallpaper? Call RJ 961-4844.

J. RIGBY BOYCE
PAINTING CONTRACTORS
Residential/Commercial-Interior/Exterior
Licensed Free Estimates
Insured
Call us 453-0607

H and K Painting. Interior. Insured. Light trash hauling. 453-8123 or 427-3727

H AND K HOME REPAIRS OF PLYMOUTH-CANTON
Small jobs, carpentry, electrical, plumbing and painting. Insured. Bob 495-0113.

CAROL'S CUSTOM DRAPERIES. Balloons, Austrians, Cornice boards. Fabrics available. 422-0231

ALTERATIONS — Remodeling — major and minor repairs or will come to your home. Call Aurora, 453-4180

PLASTERING
Specialist in small water damage & repairs. 35 years experience. Call Roy 459-7197.

AMERICAN AUTO REPAIR
Certified, quality repairs, downtown Plymouth. Personal service from Mike — owner, manager and mechanic. 451-7330

JAMES DUNN CONSTRUCTION HOME IMPROVEMENTS
All types of home improvements and remodeling, big and small. Call 455-8384. Licensed and insured.

HOME IMPROVEMENTS AND REPAIRS OF ALL KINDS. NO JOB TOO SMALL. LOCAL REFERENCES. FREE ESTIMATES. DON THOMA
PHONE - CANTON 961-0857

Services

QUALITY DECKS AND CARPENTRY
General remodeling and repairs. No job too small. Licensed. WALT-525-1707.

I'll start your deck — you finish it. H & K Home Repair. 495-0113.

JERRY'S PAINTING
INTERIOR/EXTERIOR FREE ESTIMATES
462-3144

LEE TERRY ASSOCIATES
SECRETARIAL/WORD PROCESSING
New in Plymouth. SPECIALIZING IN LEGAL AND REAL ESTATE. Also, resumes, manuscripts, reports, etc. Small congenial staff ready to give you the professional and personalized service you deserve. Notary on staff. You've tried the others — now try us.
454-9309

QUALITY LEGAL SERVICES AT REASONABLE RATES. UNCONTESTED DIVORCE, (NO CHILDREN, NO PROPERTY): \$385.00. DIVORCE (WITH CHILDREN) FROM \$625.00. BANKRUPTCY, FROM \$550.00. DRUNK DRIVING, FROM \$365.00. ONE SIMPLE WILL \$80.00. COURT COST ADDITIONAL. FOR PERSONAL ATTENTION TO YOUR LEGAL PROBLEMS CALL ATTORNEY GARY LENTZ 348-4333.

Sharpening

BOB'S SHARP-ALL
Complete Sharpening Carbide, Steel Saws Lawn and Garden Items Gas/Electric Hedge Trimmers
8445 Canton Center 451-0589

Landscaping

Railroad ties new and used delivery available. 23501 Pennsylvania Road 1/4 mile East of Telegraph. 263-5688

Home Improvements

Complete Home Modernization. Kitchen, baths, rec rooms, bars, custom decks. Hardwood finish carpenters. Glen McIntosh 453-7751, Don Lorene 326-7186.

ROOFING

A phone call will promptly bring a knowledgeable, experienced roofer to your to your home. Guaranteed work, licensed. Gale Construction Company. 313-348-6533

Lawn Services

CLEAN TOP SOIL
3 1/4 yards only \$40 — local delivery. We pay the sales tax.

Call Green Ralinger Landscaping
463-9363

BNG Professional lawn care — cutting, trimming and edging, free estimates. 454-0178, 453-7872.

Moving and Storage

R. J. LIDDY MOVING, your local agent for Wheaton Van Lines. Local and long distance, packing service, in-home free estimates. Plymouth warehouse, senior discount. Licensed and insured. Plymouth Chamber of Commerce member. 421-7774

Antiques

ANTIQUA AUCTION
SATURDAY JULY 1, 1989
at 11:00 a.m.

over 300 numbered lots
CALL FOR DETAILS
OR FAX (313) 434-5386
SCHMIDT'S ANTIQUES, INC.
5138 WEST MICHIGAN AVE.
YPSILANTI, MI 48197
(313) 434-2690

9-5 MONDAY-SATURDAY
11-5 SUNDAY

ADRIAN ANTIQUE MARKET, July 2, 1989
show changed to: JULY 16, 1989: 8-4 p.m., Lenawee County Fairgrounds, Adrian MI. Available spaces for 150 dealers with quality antiques and collectibles. Rain or shine. Admission \$2 — (517) 263-3115

ANN ARBOR ANTIQUES MARKET — THE BRUSHER SHOW, Sunday July 16
opening 21st season, 5055 Ann Arbor Saline Road, Exit 175 off I-94. Over 350 dealers in quality antiques and select collectibles, all items guaranteed as represented and under cover, 5 a.m.-4 p.m., Admission \$3, Third Sundays. The Original!!

Articles For Sale

PIANO Mason & Hamlin upright, mahogany, Williamsburg, needle point bench. \$1,700. 455-3648

Carpeting, green & padding, 19 1/2 X 13 1/2, excellent condition. Large upright freezer, like new. Call 463-2401.

30" Tappan Gas Stove, good condition. \$50 or best offer. 453-3821

Mich-CAN Statewide Ad Network

Wanted: Generous loving families to share their home with a European or Japanese high school exchange student for 89/90 school year. Call AISE 1-800-SIBLING.

Would You Like to be an over-the-road semi-driver? Please call Eaton Roadranger Training Institute at 1-800-325-6733 for more information.

The Hunt is On! Do you have the ambition and aptitude to become a professional cross-country truck driver? Bowling Green Transportation Center in Bowling Green, Kentucky can teach you in just three weeks, on the same type of equipment J.B. Hunt uses. Tuition is \$850. Financial assistance is available. And J.B. Hunt regularly hires graduates. Must be 23 or older. 1-800-643-3331.

Tanning Beds; Wolff System. Summer Clearance! Home units from \$1595. Commercial units from \$2295. SAVE THOUSANDS! Immediate delivery. CALL TODAY! 1-800-223-6743.

Paradise Gazebos are a Pre-Fab kit 100% cedar, a quality-built 3-season building. FREE color brochure. PARADISE GAZEBOS, Rt. 2, Arkin, MN 56431. 1-800-426-6186.

Attention Veterans, home loans to buy or build 100% financing. 90% on refinances. Phone Clarence Phillips Mortgage Company, 615-684-1029, also conventional loans.

Wanted: Journeyman Tool & Die Makers, Automatic Screw Machine set up for a rapidly growing company in southern Michigan. Send resume to L & N Mfg. Co. 481 Meridian Rd., Hudson, Michigan 49247. ATTN: R. Huston.

Airline Training Interviews. America's largest nationally accredited AIRLINE TRAINING school is now conducting interviews in your area! Learn about GREAT travel/promotional opportunities in the airline industry! Call INTERNATIONAL AIR ACADEMY 1-800-950-1-FLY, St. Louis, MO.

GET RESPONSE TO YOUR CLASSIFIED AD! Advertise in the Mich-CAN Statewide Ad Network and reach a 1,219,000 circulation 25 words for \$200. Call The Community Crier at 453-6900 and ask for your advertising consultant today.

Crier Classifieds

reach the people
in YOUR community
and beyond

10 words - \$4.50
Extra words - 20¢ each
Deadline: 4:00 pm Monday
for Wednesday's paper



Your Name _____ Phone _____

Address _____

Write Your Ad Here: _____

Call: 453-6900
or clip & mail this form today!

Mail to:
The Community Crier
821 Penniman Ave.
Plymouth, MI 48170

Crier Classifieds

Articles For Sale

PINE KNOB TICKETS Two \$40 Amy Grant. June 30th. They're row G, seats 17 & 19. 455-4772

Square oak kitchen table. 30" X 30", two leaves and four Breun chairs. \$150. 81 inch pine accented couch, neutral color ottoman and two end tables. \$200. 455-6381

Lovely floral 70" sofa, excellent condition, very reasonable. 455-2768 or 348-7147

Vehicles For Sale

Cadillacs, Mercedes, Porsche, etc. direct from Government. Seized in drug raids. Available your area. Save \$thousands. 218-453-3000, Ext. A2003.

1980 Chevette, \$945 or best offer. Excellent condition. 453-0681

1983 Mercury Linx LTS, 5 speed, P.S., P.B., Deluxe Interior, very good condition, call after 5 p.m. 459-4533

1985 Austin Healy Sprite convertible. Fun summer car. Ask for Pete. 455-6756

GOVERNMENT SEIZED Vehicles from \$100. Fords, Mercedes, Corvettes, Chevys. Surplus. Buyers Guide (1) 805-687-6000 Ext. S-4535.

GOVERNMENT SEIZED VEHICLES! From \$100. Chevys, Lincolns, Corvettes, Pickups, Jeeps. For Buyers Guide. Call 1-518-459-3535 Ext. J-4562.

Farm Products

BERI HILL FARM
U-PICK
STRAWBERRIES
CALL FIRST 348-5457
21165 CHUBB ROAD
right off Eight Mile
four miles west of Northville
open 8 a.m. - 7 p.m.

Apartment For Rent

Lower 5 room flat, 2 bedrooms, living room, dining room, modern kitchen & bath. **RENTED** Deck. \$550.00 per month. Phone

Upper 4 room flat, 2 bedrooms, living room, dining room, modern kitchen & bath. **RENTED** available immediate. \$500.00 per month. Phone

Three- two bedroom flats for rent, 20 minutes from Plymouth. All new. Located in Ypsil. Historical Village. \$460 per month plus utilities. 453-0400 or 453-8020

Plymouth — 2 bedroom. Appliances and carpet. \$575 includes heat. Security. Year lease. 455-0361.

Canton — 1 bedroom. Stove, refrigerator and carpet. \$410 includes all utilities. Year lease. 455-0361.

Plymouth — unique two bedroom apartment, carpeted, jacuzzi and sky light in bathroom, Jenn-Air range, dishwasher and microwave, washer & dryer. Basement privileges. \$750.00 plus utilities, references. 437-5641.

Homes For Sale & Open Houses

GOVERNMENT HOMES from \$1 (U. repair). Delinquent tax property. Repossessions. Call (1) 805-687-6000 Ext. GH-4535 for current repo list.

Mobile Homes For Sale

1981 Kirkwood Trailer, 14 x 60, 2 bedroom, with storage shed. Holiday Estates. \$13,500.00. 454-0196.

Situation Wanted

PLYMOUTH & NORTHVILLE AREA — Single parent with 5-year-old child wishes to rent small house, flat or apartment. 454-0225 after 5 p.m.

Moving Sale

MOVING!

Ludwig drum set, freezer, table saw, skis and boots, snapper lawn mower, 3 Schwinn bikes, call 455-5674

Moving Sale — Thursday, June 29. Typewriters, refrigerators, bedroom suites, sofa. 44966 Forest Trails Drive, Canton.

Garage Sales

3 FAMILY — Lindsay Dr., Ann Arbor Trail and Riverside area. Thursday June 29 thru July 1, 9-4:00 p.m.

Plymouth — Wed., thru Sat., 9-4 p.m. Antique - end tables, dining table, utility cabinets, bikes, boys clothing, many household items. 42025 Micol Dr. E. of Ann Arbor Tr. between General Dr. & Eastside Dr.

Garage Sales

Canton: June 29, 30, July 1. Household goods, children's clothes, misc. 45176 Quaker Hill, Sheldon and Warren.

Thursday 9-5 p.m. and Friday 9-2 p.m. — Baby items, antiques and household items. 711 Burroughs, E. of Main St. and N. or Ann Arbor Rd.

Employment Market

Help Wanted

Hair Designers — you can make money now while gaining experience. Fabulous entry level career opportunities in our new performer dept. for licensed hair designer at our Ply/Canton salons. Benefits include guaranteed wage, profit bonus, ongoing education advancement, insurance available, credit union, paid vacation, flexible hours (full or part-time). Opportunity to own a salon; individual, national and international publicity. For a confidential interview, call Carol or Mark 451-8250 or 981-7100.

EXCELLENT OPPORTUNITY for college student with nurse aide experience to care for quadriplegic man 2 nights a week 10:30 p.m. - 5:30 a.m. Time to study & sleep. Rate is open, non-smoker, references. Call Muriel after 2:30 p.m. only. 453-3563.

BE ON T.V. many needed for commercials. Now hiring all ages. For casting info. Call (815) 778-7111 Ext. T-511

Part-time — Office Cleaning — Evenings. 9:30 p.m., Mon.-Fri. Canton area. Great for homemakers. Also, Plymouth, Novi area, part-time, evenings, 6:00 p.m., floor care. Experienced preferred. 326-3385

Janitorial service needs part-time reliable worker. 451-6868

OAKWOOD CANTON HEALTH CENTER

Clinic nurse and medical assistant positions are available for our multi-specialty physicians office. Emergency room nurse, ER experience required. Contact M.J. Essenmacher. 459-7030

RESIDENT MANAGER

Permanent, full-time opening for a resident manager couple of our 117-unit senior citizen apartment complex located in CANTON, MI. Ideal opportunity for a married couple whose caring attitude and genuine fondness for serving and helping older adults is complemented by strong administrative and general management abilities and knowledge and experience regarding physical plant maintenance. Compensation includes salary, a 2-bedroom apartment and utilities, health and life insurance. We maintain a non-smoking work environment. Send letter of introduction or resume detailing past experience and salary history or requirements to: Director of Human Resources, Dept. CM, 2335 North Bank Drive, Columbus, OH 43220. An Equal Opportunity Employer.



A Great Place To Work!
MICHIGAN'S LARGEST REAL ESTATE COMPANY

Call Joe Melnik at 455-7000
Plymouth-Canton

Real estate's most complete training program.
©1989 Real Estate One, Inc.

Help Wanted

GOVERNMENT JOBS \$16,040 - \$59,230/yr. Now Hiring. Call (1) 805-687-6000 Ext. R-4535 for current federal list.

KIDS THRU SENIORS

The Crier is now looking for carriers on many routes! If you are interested in a money-making opportunity, call 453-6900.

Car cleaning — part-time full-time positions. Experienced, \$6-8 hour. Also willing to train. Plymouth. 420-2224

\$\$\$

ADD TO YOUR INCOME. Work Friday/Saturday in your local supermarket passing out food samples. Must have reliable transportation and like people. Senior citizens and homemakers welcome. Call 846-7063 Mon-Thur 10am-4pm for interview.

AIRLINES NOW HIRING. Flight Attendants, Travel Agents, Mechanics, Customer Service. Listings. Salaries to \$105K. Entry level positions. Call (1) 805-687-6000 Ext. A-4535.

DRIVER WANTED — Tues. Evenings. Responsible person with reliable transportation. Call Phyllis 453-6900

ATTENTION

Looking for full and part-time help now through December. Excellent income, no investment, free trip to Hawaii. 261-4327 or 729-4776

HELP

I need 6 full-time and 10 part-time people for my business. Full training. Start now. 453-7803 or 453-2970

FOOD SERVICE — Variety Vending and Food Service, Michigan's largest independent manual and vended food services establishment, would like to add one person to its Plymouth deli for part-time work Mon.-Fri., 10 a.m.-2:30 p.m. If you would like to join a growing company who has serviced the Metro-Detroit area for over 61 years, please call Ms. Carol. 756-8105

Help Wanted

EARN MONEY Reading books! \$30,000/yr. Income potential. Details. (1) 805-687-6000 Ext. Y-4535

HERBALIFE independent distributor. Call for products. 453-7802 or 453-2970

EDUCATIONAL SALES

Part-time. 20 to 25 hours per week. \$250 guaranteed if you qualify, excellent training, teaching background helpful. For interview call Carole Knapp. After 4:00 p.m. 464-0931

Hair designer needed for a full service, aggressive salon. Clientele available for an energetic individual. Opportunity awaits in our international franchise HAIR PERFORMERS. Education and advancement available. Two new Plymouth-Canton area salons. Call Carol or Mark today. 451-8250 or 981-7100

ATTENTION — College students and homemakers. We need 25 fun people to turn spare time into spare cash, so join the fun now. Make your own hours, free training and supplies. Call now between 9am and 6pm. 981-1721.

ARBOR DRUGS CASHIERS STOCK

Full and part-time opportunity for mature, dependable cashiers and stock help in one of America's fastest growing drug store chains. Arbor offers employee discount, flexible hours, paid benefits and a clean, pleasant atmosphere. Cashiers must be at least 18 years of age. Stop by for application.

ARBOR DRUGS PLYMOUTH TOWNSHIP
1400 SHELDON RD./ANN ARBOR RD.
EOE

Friendly home parties has openings in this area for managers and dealers. Free training, commission up to 25%, override up to 7%, no paper work, no delivering or collecting, highest hostess awards. No handling or service charge. Over 800 dynamic items of toys, gifts, home decor and Christmas decor. For free 1989 catalogs, call 1-800-227-1510.

Hardee's

This is your opportunity to join Hardee's Restaurant Team. Hardee's is looking for bright, energetic and friendly people. Hardee's has what it takes to win you over.

- FLEXIBLE SHIFTS AND WORK HOURS
- DISCOUNT ON MEALS
- PAID BREAKS
- UP TO 60 POSITIONS AVAILABLE
- COMPETITIVE WAGE UP TO \$4.50/HOUR
- LIFE INSURANCE
- HOSPITALIZATION
- PAID SICK DAYS FOR FULL TIMERS
- PAID VACATIONS FOR FULL TIMERS
- OPPORTUNITY FOR ADVANCEMENT
- EMPLOYEE REFERRAL BONUS OF \$25-\$50

OUR NEW PLYMOUTH TWP. LOCATION

Located South of 5 Mile Rd. on Sheldon Rd.
Now Accepting Applications At The Site Or Call:
Monday - Friday Between 8:30 a.m.-6:00 p.m. 454-8975

INDEPENDENT CARPET CELEBRATES INDEPENDENCE DAY!

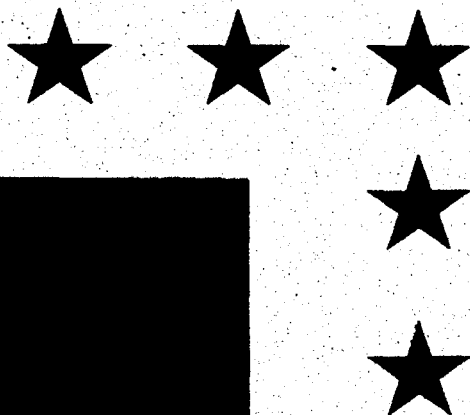

PG. 41 THE COMMUNITY CENTER June 24, 1999

DYNAMITE SAVINGS!

SALE

LEES *Twist*

10 year wear warranty and foot print free. Stainmaster.



Stainmaster Textured Plush

If style, comfort and color are essential to your decorating scheme, this is the carpet for you. The lush, solid color textured plush pile will enhance the look of any room in your home.

All available in stock for immediate & professional installation.

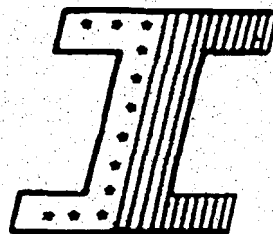

INDEPENDENT

CARPET

920 S. Wayne Road
Between Michigan & Ford Rd.
Near Cherry Hill

729-6200

HOURS: MON.-FRI. 9-9
SAT. 9-6 • SUN. 12-5

1	FORD RD		
2	FRENCH	10	
3		PARADETTA	
4	OLD BOND	12	CHERRY HILL
5		PALMER	
6		WELDON	

Bold Textured Twist

create the excitement in your home you've been looking for with the outstanding bold textured twist carpet. Choose from a selection of solid colors that will enhance traditional, country and contemporary room decors.

LEES



Stainmaster



We Pledge To Give You The Edge!

- ★ A Huge Selection of Cars & Trucks in Stock with the equipment & colors you want.
- ★ Competitive Financial Rates.
- ★ Free tank of Gas with each new car, truck or van purchase.
- ★ Visit Our New Display Area at 7 Mile & Sheldon Rd.
- ★ Display Area open 7 days a week, 24 hours per day.
- ★ Lifetime Service Participating Dealer.
- ★ A caring Sales Staff That Lives Where You Live, and Shops Where You Shop.



S & W PRO HARDWARE

875 ANN ARBOR RD., PLYMOUTH, MICHIGAN

PHONE: 453-1290

Supplement to
THE COMMUNITY CRIB



BB 4286 1



★ BARGAINS OF THE MONTH ★

MACCO
PREMIUM QUALITY
LIQUID NAILS
Great for installing paneling. Bonds most building materials. Waterproof. 10.5 fl. oz. (4) (LN601B).

99¢

Master
HIDE-A-KEY CASE

Master's top selling pin tumbler lock, plus handy rustproof magnetic key case. Maximum security lock features double locking, cut resistant, high tech steel shackle, pin tumbler mechanism. One pair of keys included. (2) (3005-D).



\$3.99

Vermont American
ALL PURPOSE
SPIN-A-BIT

Bits are always at hand in easy to use, easy to carry compact case. Set contains Philips, slotted and magnetic bit holder. (1) (15587)



\$3.99

Tasco
AMERICAN MADE
3-SPEED BREEZEBOX

20-in. blade, rugged steel housing. Powerful motor (8) (4723)



\$19.99

40-QT. ICE CHEST

With sturdy hinged lid, friction fitted. Includes ventilated food tray. (3) (1940)

\$13.88



SKIL WRENCH

3/8" DRIVE POWER WRENCH

3/8" Drive, 120 RPM, 3 hour rechargeable time. (7) (2238)

\$42.99



GE BUGS CAN'T SEE THEM
BUG-LITES

Use on porches, patios, walkways, driveways, in garages (5) (41284) (6) (41291)

YOUR CHOICE
60 OR 100 WATT

\$1.99
2-PACK



Some merchandise shown may vary in color. No charge amount, note and possession of this advertisement does not obligate us to sell at the listed price. Copyright 1987 © Printed in USA

JOHNSON.
LEVEL & TOOL



PROJECT POWER
PROJECT POWER
PRECISION
MAGNETIC
TORPEDO
LEVEL

\$3⁹⁹

9-in. length
magnetic 3 vial
top reading
A.B.S. plastic.
(14) (7500M).

HEAVY DUTY
POWERFUL
TACKER/STAPLER

\$12⁹⁹

Shoots 6 sizes of T-50 staples. All-steel construction. Jamproof mechanism. (22)(T-50)



EMHART

\$11⁹⁹

SOLID STATE CONSTRUCTION.
THERMOGRIP 208 GLUE GUN

High output trigger feed. Bonds wood, leather, cloth, tile, paper, most porous materials in about one minute. (15)(208)



EMHART

\$11⁹⁹

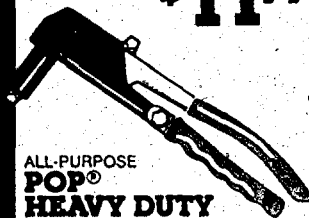

ALL-PURPOSE
POP[®]
**HEAVY DUTY
RIVET TOOL**

Sets 1/8-in., 5/32-in. and 3/16-in. diameter rivets. Extended nosepieces for hard-to-reach places. (16) (K111)

BLACK & DECKER
\$54⁹⁹



18-TOOTH PIRAHNA BLADE
2 1/4 H.P. CIRCULAR SAW

Powerful motor. Metal upper and lower blade guards. Sawdust ejection chute. 2 year warranty. (11)(7392P)

FULLER

CHROME PLATED
**6-PC.
WRENCH
SET**

\$9⁹⁹

Made of
alloy steel,
hot drop
forged.
(19)(1374)



YOUR
CHOICE

\$7⁹⁹

HEAT TREATED
STURDY HAND TOOLS

Choose 10-in. groove lock plier (17) (113) or the 8-in. adjustable wrench (18)(8).

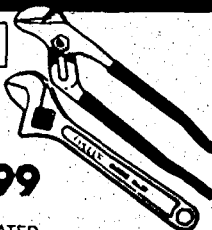

AKRO-MILS
AKRON, OHIO 44309

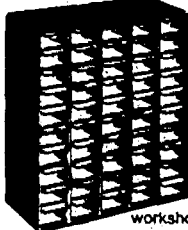

STACKABLE STORAGE
**50-DRAWER
NON-METAL
CABINET**

\$9⁹⁹

See-through drawers, recessed tray top. Perfect for workshop, hobby or household use. (12)(10-350)

FOR THE HANDYMAN
**POLY-
PROPYLENE
TOOL BOX**

\$9⁹⁹

Cantilevered tray on sturdy steel hinges. Durable latching closure. Roomy. (13)(09-058)



**AUTO-
BERNZ**
BY
BERNZOMATIC

AUTOMATIC FLAME STARTER

**AUTO-BERNZ
TORCH KIT**

\$19⁹⁹

Lights at the touch of a finger. Fully adjustable flame. Includes propane fuel cylinder. (20) (AB2000)

**REPLACEMENT
PROPANE
CYLINDER**

\$24⁹⁹

(21)(TK9)

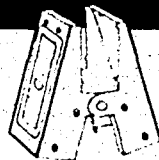

**H
HAGER.**

LIGHTWEIGHT
**SAWHORSE
BRACKETS**

\$1⁹⁹
PAIR

Flanged nail holes for ease of assembly. Use with 1 1/2 x 3 1/2 in. or 2 x 4 in. lumber. (23) (1787-BL)



STANLEY

Vermont
American
\$8⁹⁹

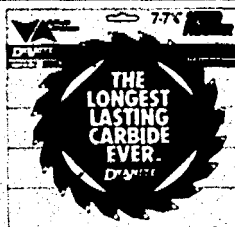

LONG LASTING
CARBIDE TIP
**NEW 7 1/4-IN.
SPEED FRAMER BLADE**

For circular saws. Makes super fast cuts. Bend-resistant body, requires less force, easier on saw. Dyanite carbide teeth. (27)(27810)

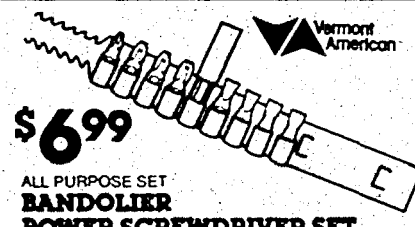

Vermont
American
\$6⁹⁹

ALL PURPOSE SET
**BANDOLIER
POWER SCREWDRIVER SET**

Holder wraps around power or cordless screwdriver or screw gun. Bits are at hand for easy use. Includes most popular slotted and Phillips bits (28)(15681)

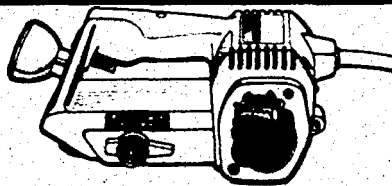

BONUS 3 FREE BELTS
**SANDCAT
BELT SANDER**

2 1/2 x 16 inches. Powerful 2.8 amp motor. Exclusive locking lever for easy sanding belt replacement. (29)(102-01)

\$54⁹⁹

SKIL



\$39⁹⁹

LOCKING TRIGGER SWITCH
**3/8-IN. VARIABLE SPEED
REVERSING DRILL**

1/3 horsepower, 3.0 amp. Variable speed range 0 to 2,500 RPM, forward or reverse (28)(6225)

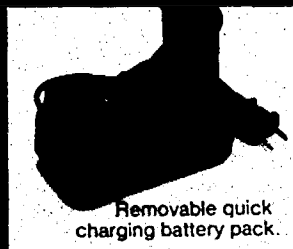

Removable quick
charging battery pack.



3M
HEAVY DUTY
POWER SANDING BELTS

Cuts faster and lasts longer than conventional glue bond belts. 3x21 inches. Fine (30)(9264), Medium (31)(9265), Coarse (32)(9266)

\$1⁵⁹
YOUR CHOICE EACH

Countess
WISS METAL WIZZ SNIPS
A workshop must have
(37)(IMPC 3)



\$6⁹⁹

Weller



FOR HOBBYIST, HANDYMAN
**SOLDERING
GUN KIT**

\$19⁹⁹

Includes gun, cord, more
140-100 watts (38)(8200PK)

Master Lock

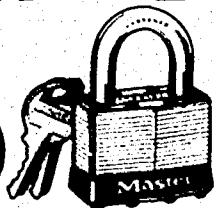

SECURITY MINDED
**1 3/4" STEEL
LAMINATED PADLOCK**
Includes two keys. Protect your valuables
(36)(10)

\$4⁹⁹



YOUR CHOICE
\$5⁹⁹

STURDY
**4' COILED
COMBO BIKE LOCK**
Made of sturdy cable, plus a rugged combination lock
(34)(8144D)

**4' WELDED CHAIN
BIKE LOCK**

Rubber lock guard protects bike's finish (35)(8134D)

IRWIN.
\$3⁹⁹
**CHALK & REEL
COMBO PACK**



100' line makes sharp, clear lines with no messy chalk refills
(33)(64499)

COMPACT 18-IN LENGTH
SHORT-CUT SAW

\$9⁹⁹

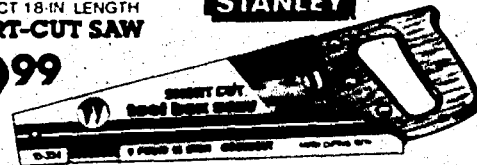

Super-fast cutting with new tooth design. Includes square mitre feature. Easy to handle, store. (25)(15334)

AMES TRUE TEMPER

VERTICAL SQUEEZE GRASS SHEARS
Safety catch, hang-up hole.
(49)(23-230)
(54)(GS300)

\$4⁹⁹



RELIABLE STURDY HEDGE SHEARS
Serrated top blade, shock absorber.
(48)(23-011A)(53)(TD)

\$12⁹⁹



GARDENER'S HELPER ROUND POINT SHOVEL
Forward-turned steps, long wooden handle (47)(15-813) (52)(SLR)

\$6⁹⁹



GIARDI FOR SMALL ENGINES SPARK PLUG
Fits all popular small engines.
(43)(SP34)
\$1⁰⁹ EACH

FOR STRING TRIMMERS LOOP TRIMMER REPLACEMENT LINE

50' length. 085 DIA. **\$1²⁹**
50' length. 80 DIA. **\$1⁴⁹**

(41)(WL-65) (42)(WL-80)



BLACK & DECKER

18" DOUBLE EDGE DELUXE HEDGE TRIMMER

Reciprocal blades cut in either direction. Safety switch, function clutch for motor. Blade protection. U.L. listed
(44)(8124)

\$44⁹⁹



PARAMOUNT

12" CUT ELECTRIC STRING TRIMMER

For small to medium size lawns. 1/4 H.P. motor, bump feed semi-automatic line advance U.L. listed double insulated handle. (40) (PT120)

\$34⁹⁹

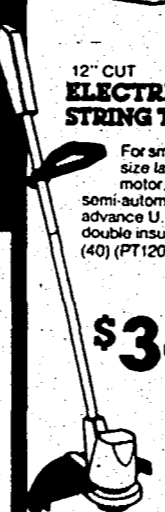

Rubbermaid

LOW PROFILE 5-GALLON GAS CAN

Stable base minimizes tipping. No-rust. Corrosion resistant. Easy-grip handle. (58) (1251)

\$6⁸⁸

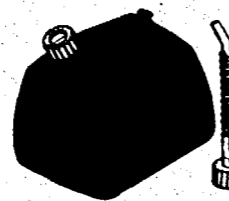

TRUE TEMPER AMES

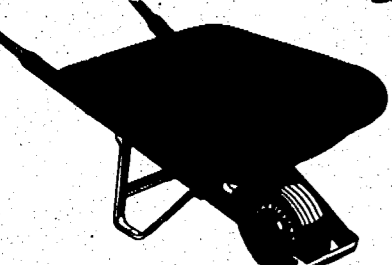

4 CUBIC FEET SIZE POLY-TRAY WHEELBARROW

Pneumatic tire, wood handles, oilbute bearings, seamless tray. (45)(24-350) (50)(P450)

\$34⁹⁹

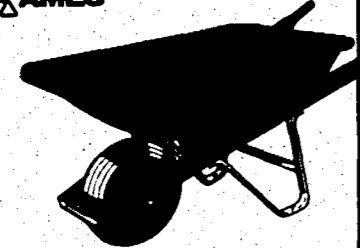

SEAMLESS STEEL TRAY 4 CUBIC FEET WHEELBARROW

Pneumatic tire. Oilbute bearings. Wood handles. (46)(24-310) (51)(5W)

\$29⁹⁹



SPLIT COWHIDE MEN'S DRIVERS' GLOVES

\$3⁹⁹



WELLS LAMONT

PVC OVERLAY MEN'S KNIT GLOVES

\$1⁷⁹

Nylon knit, coated with PVC for added wear, sure grip. (57)(510L)

Warp's

HEAVY DUTY PLASTIC EASY-EDGE LANDSCAPE BORDER

Curves or lies straight. Rolled top edge, safe for mowers, feet 5-in. x 20-ft. Black (55)(LB520B)

\$7⁹⁹

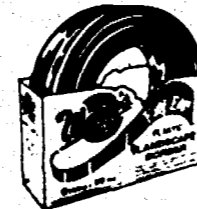

\$4⁹⁹ PAIR

FOAM RUBBER KNEE PADS

Poly straps hold pads on securely. (59)(317)



FREE 28-2-3 PREMIUM FORMULA PRIZE LIQUID TURF FOOD
\$5⁹⁹

Covers 5,000 sq. ft. Fasten hose, use as directed. Slow-release. (60)(7527)

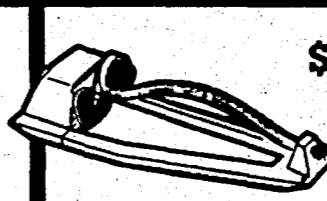

\$6⁹⁹ NELSON. \$4⁹⁹

NON-PUDDLING RAINSHOWER 43 OSCILLATING SPRINKLER

Covers up to 43x66 ft. area. Patented Turbo-Heart mechanism for uniform watering. 59-position control. (74)(1025)



SNAP CONNECT DIAL-5 NOZZLE SET

Snap together, apart instantly. Thumb control on/off flow dial. (73)(2960)

NELSON. SPRINKLERS

YOUR CHOICE \$4⁹⁹

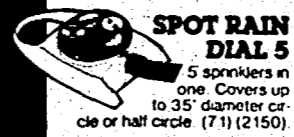

SPOT RAIN DIAL 5
5 sprinklers in one. Covers up to 35' diameter circle or half circle. (71) (2150)

RAINPULSE 85 IMPACT SPIKE

Adjusts to water up to 85 ft. diameter circle. Dial, diffuser pin control distance. Water-saver, no-splash arm. (70) (1180)

RAINSHOWER 40

Non-pudding. Covers up to 2600 sq. ft. Patented Turbo-Heart mechanism for uniform watering. (72) (1015)

SWAN

RUBBER-VINYL GARDEN HOSE SOFT AND SUPPLE HEAVY DUTY HOSE

Outstanding kink resistance, burst pressure. Washerless coupling. 5/8 in. x 50 ft. Lifetime guarantee (63) (SS5850)

\$14⁹⁹



RUBBER-VINYL HOSE SOFT AND SUPPLE GARDEN HOSE

5/8-in x 75 ft. (85)(SS5875)

\$19⁹⁹



STRONG, ALL WEATHER 4-PLY KNIT WEATHERFLEX HOSE

High burst strength, kink resistance. Gripper coupling for water-tight connections. 5/8 in. x 50 ft. (64) (WF5850)

\$9⁹⁹



CHAPIN

2-GALLON SPRAYER

\$24⁹⁹

Polypropylene pump, wide tunnel top for easy fill. Extension rotates 360° for easy filling. (77) (3502)



Gilmour

POLYMER BODY SELECT-A-SPRAY NOZZLE

Non-corroding, high impact body (75)(586)

\$3⁹⁹

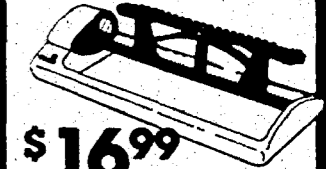

\$16⁹⁹

PROGRAMMED LAWN WATERING PATTERN MASTER OSCILLATOR SPRINKLER

Covers 248 to 4,000 sq. ft. Made for large or small lawns. Water only where you desire. (76) (8880)



DRAGON

WIPE OUT INSECTS LIQUID SEVIN INSECTICIDE
For vegetable crops, ornamentals, lawns, more. (78)(6416)



DIAZINON INSECT SPRAY

Kills bean beetles, aphids, root maggots on certain vegetables, more. Also use on lawns (79)(1116)



MALATHION SPRAY

Use on ornamentals, inside the house, for dog and cat fleas, too. (80)(1916)



YOUR CHOICE \$3⁹⁹ EACH

McCULLOCH

15" CUTTING SWATH GAS STRING TRIMMER

\$84⁹⁹

21.1 cc engine, primer carburetor, electronic ignition, semi-automatic choke. Debris shield, built-in line cutter (82) (MAC 60-SX)



TRUE TEMPER AMES

FRONT LOAD POLY HOSE REEL

\$22⁹⁹

Stores 150 feet of 5/8 in diameter hose. No-kink hose guide. (67) (23-890) (68) (HR150C)



POLY HOSE HANGER

Keep garage, garden neater (66) (23-840) (69) (PH-1)



\$999

STERLING

**LESS POP-UP
WASHERLESS TWIN HANDLE
LAVATORY FAUCET**

Non-metallic, corrosion proof construction. 5-year drip-free limited warranty. Water miser aerator. (84) (063-72)

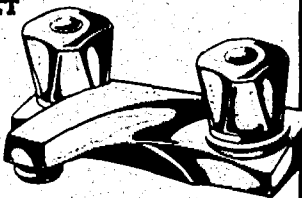

**FAUCET WITH POP-UP
\$1399**

(85) (063-82)

EVEREADY

**LONG LIFE
ENERGIZER
ALKALINE
BATTERIES**

For radios, toys, games.
2-pack "C" (97) (E93BP-2)
2-pack "D" (98) (E95BP-2)
Single 9-volt (99) (E22BP)

**YOUR
CHOICE \$199**

ENERGIZER

ENERGIZER

**"AA"
BATTERIES**

\$269
FOUR PACK
(100) (E91BP-4)



INTERMATIC

**7-DAY SCHEDULER
PLUG-IN LAMP
APPLIANCE
TIMER**

Separate radio, TV, lights programming for 7 full days. Use in any wall outlet. Heavy duty load capacity. Manual on/off override switch. U.L. listed. (96) (SB911)

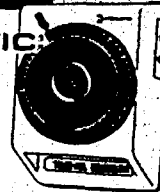

Lifesaver

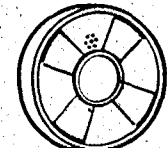

**SMOKE
ALARM
\$599**

Five year warranty. Test button, low battery chirp sound. Battery included. (86) (0905)

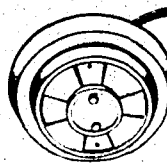

\$1699
DC BATTERY BACKUP
A/C 120-VOLT
SMOKE ALARM

Professional smoke alarm with single or multiple station with interconnect. (87) (1255)

BRING GOOD THINGS TO LIFE
YOUR CHOICE

\$149
4-PACK
**INSIDE FROST
LIGHT BULBS**

40 watts (88) (1325540A)
60 watts (89) (4102660A)
75 watts (90) (4103075A)
100 watts (91) (41034100A)

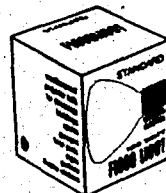
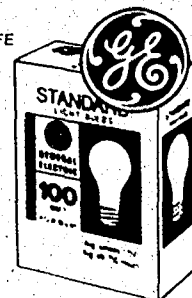

\$299
EACH
WEATHERPROOF
STANDARD
FLOODLIGHTS

For driveways, sports, garages, gardens and more.
75 watts (92) (1613775PAR/FL)
150 watts (93) (15608150PAR/FL)

**BRIGHT BRASS
SINGLE
CYLINDER
DEADLOCK**

Operated by key from outside, turnpiece inside. (83) (870X3CP)

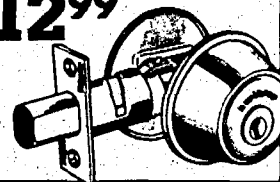

\$1299

DURACELL

**COPPERTOP
ALKALINE BATTERIES**
Last up to 3 years in storage.
2-pack "D" (101) (MN1300B2)
2-pack "C" (102) (MN1400B2)
Single 9-volt (103) (MN1604B)

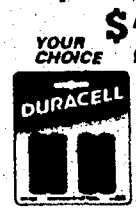

**YOUR
CHOICE \$219**
"AA"
BATTERIES
(104) (MN1500B4)



\$289
FOUR PACK

ELECTRIPAK

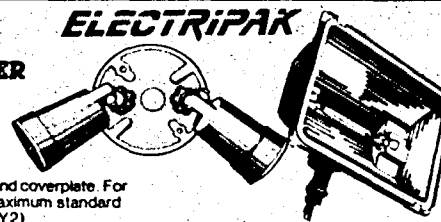

FOR PAR LAMPS
**LAMPHOLDER
ASSEMBLY
\$599**

Includes lampholder and coverplate. For use with 150 watt maximum standard floodlight (95) (11SLY2)

**300 WATTS
QUARTZ
FLOODLIGHT
\$1199**

Bright beam lights up to 9,000 sq. ft. Provides natural color light. (84) (DR300Q1)



**MODEL
HOME**

\$179

ASSORTED COLORS
**MODEL
HOME
PAINTS**

For exterior and interior use. (120) (SP)



PARKS

WOOD FINISH
**CLEAR
POLYURETHANE**

**YOUR
CHOICE**

\$499

Enhances beauty of floors, paneling, furniture while protecting from moisture, abrasion. 1-qt. can. (118) (0514) gloss or (119) (0524) satin finish.

\$179

EMPIRE



3"x19"
RUST REMOVAL BRUSH

Oil tempered carbon steel bristles, 1" trim (117) (67-0952)



WITH SILICONE
**WHITE ACRYLIC
LATEX CAULK**

Moisture and mildew resistant. Paintable, excellent adhesive, lifetime warranty. 10.5 oz. (112) (181011)

\$119



**WHITE SILICONE
SEALANT**

Simple to use, cleans up with water. Paintable, excellent adhesive, lifetime warranty. 10.5 oz. (113) (08654)

\$399



NATURAL
**WOOD
DOUGH
\$119**

Fills cracks, holes and gouges. Waterproof. (110) (21141)



**VINYL
SPACKLING
99¢**

Repairs holes, dents, cracks, sands smooth. Use on plaster, drywall, wood. 1/2 pint (114) (12130)

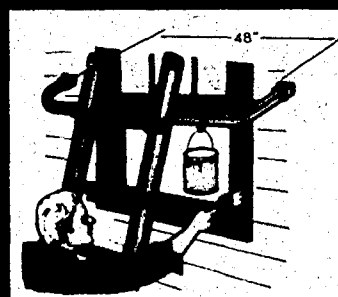

**RECTANGULAR
LADDER STABILIZER**

Use on aluminum ladders of all duty ratings. All hardware included. (109) (97)

\$1999

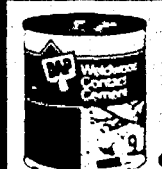

\$279
CONTACT CEMENT

Premium quality neoprene contact cement dries in 15 minutes. Pint. (111) (00271)

**RUST-OLEUM®
SUPERIOR METAL PROTECTION
AEROSOL
PROTECTIVE
COATING
\$299**

Protects against moisture. More paint solids for greater, long-lasting coverage. 12 oz. can. (115) (7700)

**PRIMER PROTECTIVE
COATING
\$599**

For clean or rusted metal. 1 qt. can. (118) (7700)

**CORROSION REMOVER
ALUMINUM JELLY**

Cleans, brightens aluminum screens, storm doors, lawn furniture, more. (121) (AJ-1)

**REMOVES RUST
NAVAL JELLY**

Great for tools, working metal parts. Restores surfaces. (122) (NJ-1)

**LIME, STAIN REMOVER
TUB 'N SINK JELLY**

Dissolves lime, rust, hard water discolorations. (123) (STJ-1)

**YOUR
CHOICE 1.89**
MFR. MAIL-IN
REBATE **-1.00**

**FINAL COST
AFTER REBATE
89¢**

QUICK GEL SUPER GLUE

Bonds in seconds. Thick, no-run formula. (124) (SGG-1)

SALE PRICE **1.00**
MFR. REBATE **-1.00**

YOUR
FINAL
COST **FREE** AFTER
MAIL-IN
REBATE

EZ PAINTR.

HIGH QUALITY
PAINT BRUSHES

Polyolefin specially formulated for great results with all paints.

LITTLE BUSTER BRUSH
2" brush for stairs. **\$149**
(G322-20-73)

BIG BUSTER BRUSH
4" brush tackles the
big paint jobs. **\$299**
(G322-40-73)

ELMER'S

PROFESSIONAL
**CARPENTER'S
WOOD
GLUE \$149**

8 oz. size. Dries fast. Allows repositioning before clamping. No harmful fumes. (130) (E701)

WITH 5 BLADES
**RAZOR BLADE
SCRAPER 99¢**

All steel. Pushbutton controls locks in or retracts blade. (125) (13050)

HYDE
FLEXIBLE BLADE
1 1/2"
**PUTTY KNIFE
\$219**

Black and silver. So many uses! (127) (02100)

**PAINTER'S HELPER
5-IN-1
PAINTER'S TOOL
\$349**

Sharp scraper blade, putty remover, spreader, many more uses. (126) (02870)



**GREAT FOR METAL
WD-40
SPRAY
LUBRICANT**

Stops squeaks, protects metal, loosens rusted parts, frees sticky mechanisms. 6 oz. can. (138) (42060)

99¢

swan



\$5.99

**KINK RESISTANT
FAIRLAWN REINFORCED
VINYL HOSE**

Solid brass full-flow couplings. Clear knit construction. 5/8-in. x 50 ft. (134) (FA 5850).

CHAPIN

**POLYETHYLENE
3-GALLON
TANK SPRAYER**

9-in. pump, 30-in. hose with 18-in. extension. Lightweight, easy to use. (136) (2503)

\$17.99



EMPRE

**CLEAN SWEEP VALUE
18" SUP'R BRUTE
PUSH BROOM**

Palmyra bristles. 60-in. self-locking handle won't come out in use. (135) (25-2811)

\$7.99

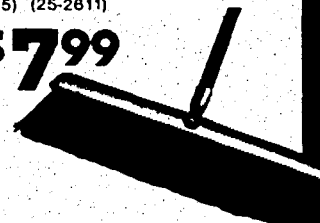

ENERGIZER

**7 WAY LIGHT
ENERGIZER
FLUORESCENT
SPOTLIGHT**

With amber flasher feature. Uses 4 "D" batteries, not included. (141)(9450)

\$12.99



BENGAL



**9 OZ. CAN
ROACH
SPRAY**

Easy to use. Odorless, clean. (137)

\$8.99

EMPRE

**ROLL'R COATER
DRIVEWAY SEALANT
APPLICATOR**

Circular roller applies smooth uniform coating. Features molded squeegee. (131) (29-3692)

\$7.99



monsey products co

gardner

**DRIVEWAY FILLER
& SEALER**

\$8.99



(132) (05256A)
(133) (MM)

shoo-fly



**SHOOTS 25'
SHOO-FLY
HORNET
JET BOMB**

\$2.99

12-oz. aerosol spray can. Kills hornets, wasps, yellow jackets, bees, roaches, ants, mosquitoes, more. (139) (SH144)

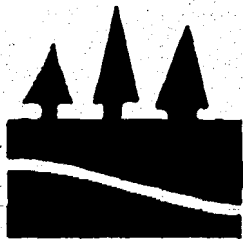

Newspaper Supplement

FINGERLE-HOLLISTER-WOOD LUMBER COMPANY

2800 E. MICHIGAN AVE. AT RIDGE RD.

MON.-FRI. HOURS: 7:30 A.M.-5:30 P.M.; SATURDAY 8:00 A.M.-4:00 P.M.

482-0735



PAL

SALE STARTS NOW, ENDS IN TWO WEEKS



WISE
BARGAIN
BUY



SALE
14⁹⁹



Split suede leather. 2 large, 2 medium and 2 small pockets, hammer loop, tape holder and web belt. 216796

OF JULY SALE

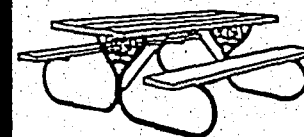

PICNIC TABLE
FRAME

Wood Not Included

29⁹⁹

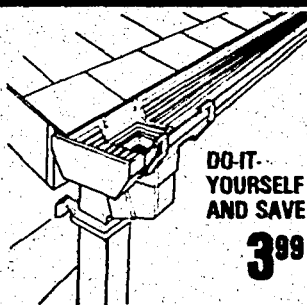

DO-IT-YOURSELF
AND SAVE!

3⁹⁹

- Outperforms metal gutter systems in every way.
- Snap together system can be easily installed by one person.
- Guaranteed against rust, rot, and corrosion.
- Competitively priced with metal gutter.
- No solvent welding. No painful cuts.

7 1/4" CARBIDE TIP SAW BLADE
24 tooth carbide tip. 15631/021592



SALE
3⁹⁹

HANSON

25' POWERLOCK®
TAPE RULE



SALE
9⁹⁹

1" x 25' non-creeping Powerlock® has locking knob, long lasting yellow mylar blade, 1/16" graduations and convenient belt clip. 33-425FP/411652

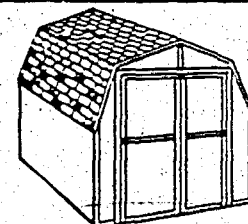

STORAGE BARN

8' x 8' **272⁹⁶**

10' x 8' **492⁹⁶**

OTHER SIZES AVAILABLE.
FLOOR INCLUDED.

TREATED DECORATIVE
WOOD LATTICE PANELS

Create a more attractive decor inside and outside your home. Perfect for decorative fencing, folding screens, patios, porches, etc.

4' x 8'
11⁹⁹

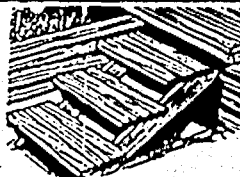

STAIR
STRINGER
6⁴⁹

DEXTER
ENTRY
LOCK
SAVE
10%

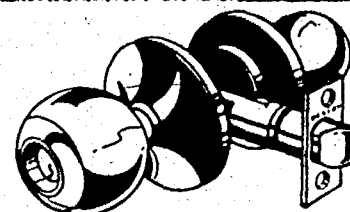

CORONA
NEW STYLE!

ENERGY SAVER STEEL DOORS

Insulated, pre-hung steel doors in stock. With threshold weatherstripping and exterior trim.

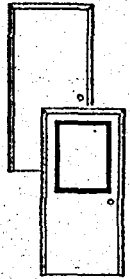

BLANK
32" **112⁹⁵**
36" **115⁹⁵**
1 LITE
32" **149⁹⁵**
36" **154⁹⁵**

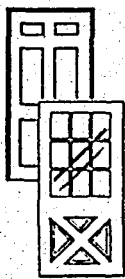

6 PANEL EMBOSSED
36" **119⁹⁵**
9 LITE EMBOSSED
32" **165⁹⁵**
36" **169⁹⁵**



WOOD SCREEN DOORS

- 32" and 36" widths.
- 1 1/4" thick.
- Hardware available.

32" **24⁹⁵**
36" **26⁹⁵**

COOK & DUNN



LATEX HOUSE PAINT

SALE **15⁹⁹** GAL.



WOOD HANDLE FRAMING HAMMER

28 oz. Milled face, #606M, 273771

SALE **19⁹⁹**



48" MAHOGANY, BRASS BOUND LEVEL

#548/186452



SALE **29⁹⁹**

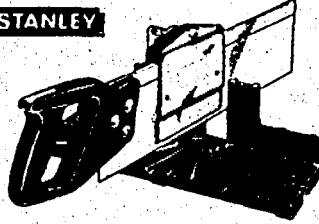

MITRE BOX

Metal box with Back Saw. 19-614/405266

SALE **21⁹⁹**



YOUR CHOICE

SALE **5⁹⁹**

TULIPKNOP LATCH FOR STORM OR SCREEN DOOR

1" to 1 1/4" thick. Black or aluminum. 11-543 175067 11-1533 175059

PNEUMATIC DOOR CLOSER

Adjustable closing power. Aluminum or black. 17-9033 175703 17-9043 175711

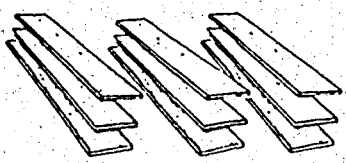

1" x 12" ROUGH CEDAR LUMBER **97^c** PER FT.

ALL GREEN-COLORED WOOD IS NOT ALIKE.

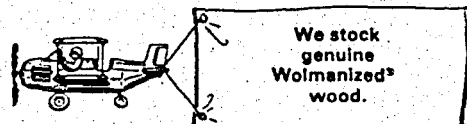

QUALITY DOESN'T COST, IT PAYS!
SEE HOW INEXPENSIVE THE REAL THING CAN BE.
NO-OBLIGATION QUOTES ON YOUR DECK OR OUTDOOR PROJECT

Transform Your Backyard With LANDSCAPE TIMBERS

Create a handsome border fence or unique planter boxes by stacking to the height you need. Ideal as edging tool CCA treated.

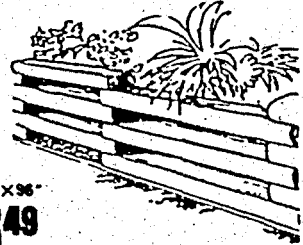

4x8x96" **649** EACH

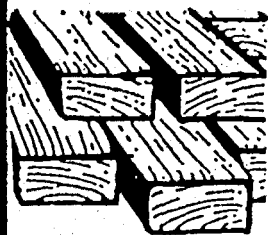

ROT RESISTANT LUMBER
The Perfect Lumber For Decks, Fences, Sheds, Any Outdoor Building Project.

SIZE	8'	10'	12'	14'	16'
2X4					
2X6					
2X8					
2X10					
2X12					
4X4					

CALL US FOR OUR EVERYDAY LOW PRICES!



4'x8' AC GRADE PLYWOOD SALE

3/8" **11⁹⁹**

READY MIX CEMENT

80 lb. Bag **2⁹⁹**

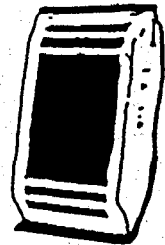

**WET OR DRY
PLASTIC ROOF
CEMENT**

159434

16⁹⁵

5 GALLON



**ALUMINUM ROOF
COATING**

159467

27⁹⁵

5 GALLON



**ROOF
FOUNDATION
COATING**

12⁹⁰



**ROOF CAULK
DAP**

99¢



ROOF COATING

159426

12⁹⁵

5 GALLON

▲ Wasco® Elite™ Skywindow®

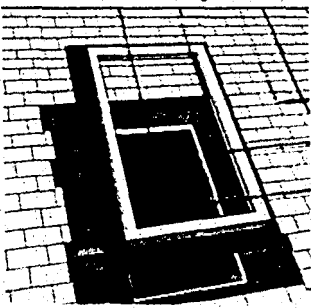

**OTHER WASCO® SKYLIGHTS
AS LOW AS 100.00**

**EASY, NO MASTIC, NO
FLASHING KIT
INSTALLATION.**

- Exclusive Ultraseal™ Flange forms a weathertight seal.
- Easy installation — no mastic, sealants or stop flashing kits required.
- Most airtight skylight available.
- Rugged one piece vinyl Permatherm® curb won't rot, peel, or warp.
- Includes Heat Mirror™ glass for summer and winter energy savings and comfort.
- Condensation gutter provided to collect and store moisture, preventing it from dripping down walls.
- Attractive styling looks good on your roof, adds value to your home.

Heat Mirror is a trademark of Southwall Technologies, Inc.

FROM 322⁰⁰



ROOFVENTS

Black or brown.
Sizes 7 1/2" or
8 1/4". 217604,
217422, 217570,
217414



SALE 5⁹⁷ EA.

**SQUARE ROOF
VENTS**

Size 9" x 9".
217406



SALE 3⁴⁷ EA.

**UNDER AIR
VENT**

Brown or white.
Size 16" x 4".
217737, 217612



SALE 97¢ EA.

STANLEY

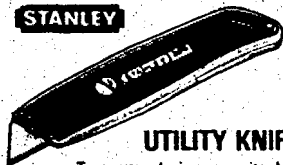

UTILITY KNIFE

Two-way design permits blade to be held in usual manner or at an angle for use as a scraper. 10-259/390559

SALE 1⁹⁹

STANLEY



UTILITY KNIFE BLADES

Pointed, reversible, razor type knife blades. Fit Stanley utility knives and most other makes. H-911/386504

SALE 99¢

STANLEY

**6 PC.
SCREWDRIVER
SET**

Full size comfortable plastic handles and forged hardened steel blades. 64-457/017533

SALE 3⁹⁹

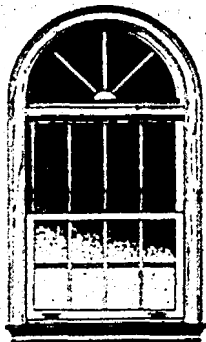
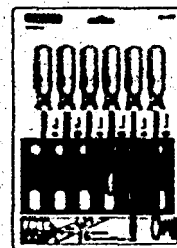

**LOOK INTO PEACHTREE WINDOWS AND DOORS
WE'RE ONE OF THE AREA'S LARGEST SUPPLIERS OF
PEACHTREE—SEE HOW INEXPENSIVE THE BEST CAN BE.**



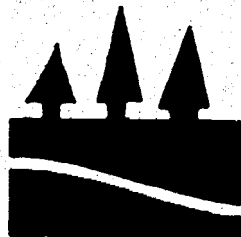

FINGERLE-HOLLISTER-WOOD LUMBER COMPANY

2800 E. MICHIGAN AVE. AT RIDGE RD.
MON.-FRI. HOURS: 7:30 A.M.-5:30 P.M.; SATURDAY 8:00 A.M.-4:00 P.M.

482-0735



PAL

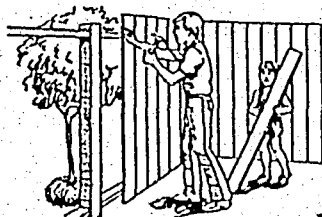

TREATED FENCE BOARDS

1" X 6" X 6" **1.65**
1" X 6" X 8" **2.20**

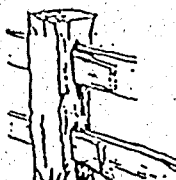

SPLIT-RAIL FENCE

2 Rails - 1 Post - 10' Sections

15.99

FRANKLIN ACRYLIC LATEX CAULK

1.99
SALE PER TUBE
LIMIT 2 CASES



8
COLORS
IN
STOCK



BLACK & DECKER® 10" MOTORIZED MITRE BOX

2 hp ball and sleeve bearing motor, gear driven blade.
Accurate miter scale with positive stops at 90°
22 1/2° and 45°. 1701/344861

149.99



SKIL 3" X 18" BELT SANDER

Patented "auto-track" belt control. Ball and roller bearing construction. Bench mountable flat top design, sands flush right up to wall. Fast change belt. Removable dust bag with zipper closure. 7313-074088

52.99

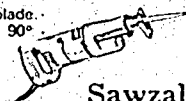

MILWAUKEE RECIPROCATING SAW Variable Speed Sawzall®

Cuts any shape in any sawable material, make plunge cuts with no starting hole. All ball and roller bearings. Rugged reciprocating mechanism, direct access to blade adjusting screws. Glass reinforced nylon handle. With steel case. 6607/250332

159.99



IRWIN.

6 PC. SPEEDBOR BIT SET

SALE **7.99**

High quality tool steel bits, one each in sizes 3/8", 1/2", 5/8", 3/4", 7/8", and 1". 88098, 183821



24" WREKING BAR

Woodings-Verona. 535625

SALE
2.99



STANLEY BLOCK PLANE

Bottom is milled. Tempered steel cutter. Blue finish, red trim. Cast-in finger rest. To adjust cutter for thickness of shavings, loosen wheel, move cutter endwise as required. 408856

SALE
9.99



BAR CLAMPS

Instant acting bar clamp. Multiple disc clutch permits instant secure hold - easy to release.

12"
SALE
5.99

18"
SALE
6.99



LASTING PROTECTION FOR YOUR DECK! WIDE SELECTION OF COLORS

SALE **16.99** GAL.
REG. 20.99

VINYL
SIDING
49.95 SQ.



This is a syndicated publication. All prices are suggested retail prices, merely a general indication of value, and are not binding on the dealer. This distributing dealer is an independent merchant who has the option to sell at prices set by him that will be competitive in his local trade area. The participating dealer's ability to stock all items during

the sales period is dependent upon the availability of merchandise from the manufacturer. The dealer reserves the right to limit quantities and to substitute items of equal or better quality. Not responsible for printing errors. L. G. COOK DIST.