

Community The Crier

December 17, 1980

The Newspaper
with Its Heart in the
Plymouth-Canton
Community

Vol. 7 No. 45

25¢

**Did mom
bomb Navy?**
pg. 3

**We'll star
on U.S. TV**
pg. 3

**Candidates
spent big**
pg. 3

**Rocks lose
state title bid**
pg. 46



Plus

THE GRAND PRIZE winner of the annual Community Crier Christmas Coloring Contest was this entry by Mike Guttentag, a fourth grader at Eriksson Elementary School. Nine-year-old Mike is the son of Gail and Michael Guttentag of Canton. The contest entrants' letters to Santa and information on the other prize winners can be found in the "Dear Santa" section in today's Crier.



EXTRA CASH FOR CHRISTMAS!

Cash for Anything made of Gold or Silver Weighed On Certified Scales

TOP CASH PRICES PAID FOR JEWELRY

We pay top cash prices for any jewelry made of gold or silver! Any jewelry marked 10K, 14K, 18K, 585, 750, 375, 925 as well as some unmarked jewelry is worth money to us! And we pay more for any unbroken gold chains or attractive re-usable jewelry! Bring in for our cash offer. Typical Prices on Used Jewelry.

	Per Gram	Per DWT Penny Weight
Men's Class Rings 10 K	\$5.60	\$8.68
Men's Wedding Rings 14 K	\$7.15	\$11.08

CONVERSION CHART

31.1 Grams	=	Per Troy Ounce
20 DWT	=	Per Troy Ounce
480 Grains	=	Per Troy Ounce

WE BUY DIAMONDS

We buy all cuts of diamonds old or new. For diamonds from .10 to .25 we pay \$1.25 to \$2.00 per point. Larger diamonds bring proportionately higher prices.

PAYING CASH FOR SILVERWARE

Top cash prices paid for any old sterling, regardless of condition--flatware, holloware, jewelry.

We pay extra for complete sets of single pieces of many flatware patterns in good condition, and for good quality holloware. Bring in for our offer.

POCKET WATCHES

We pay top cash prices for all pocket watches—running or not running, gold, silver or base metal. Paying minimum of \$100 for any repeater. Bring old watches in for our offer.

NOW OPEN MONDAY
Mon., Thurs., Fri. 9:00 to 6:00
Sat. 9:00 to 2:00

ALL PRICES SUBJECT TO MARKET

Evening Appointments Available
All Transactions Confidential

TOP CASH PRICES PAID FOR SILVER COINS Pre 1965

- Dollars, Average.....\$13.00
- Half Dollars.....\$5.25
- Quarters.....\$2.62
- Dimes.....\$1.05
- Half Dollars (1965 to 1969).....\$1.90

We also pay top cash prices for Silver coins from Canada and other countries. Bring in for our cash offer.

You don't go to a motel room to see your Doctor, Lawyer, Dentist! Don't sell your GOLD or SILVER to a motel operation. (According to a recent Detroit newspaper article there are some motel operations paying only approximately 40% of what your scrap gold or silver is worth.)

CASH PAID FOR

Rare Coins & Coin Collections

As the area's leading dealer in rare coins, we are in constant need of good quality coins. Bring in your Collection for our cash offer.

The shop for the collector and investor

PILGRIM STAMP & COIN

729 W. ANN ARBOR TRAIL PLYMOUTH, MI. 459-5275



Cantonite charged in bombing of Naval office

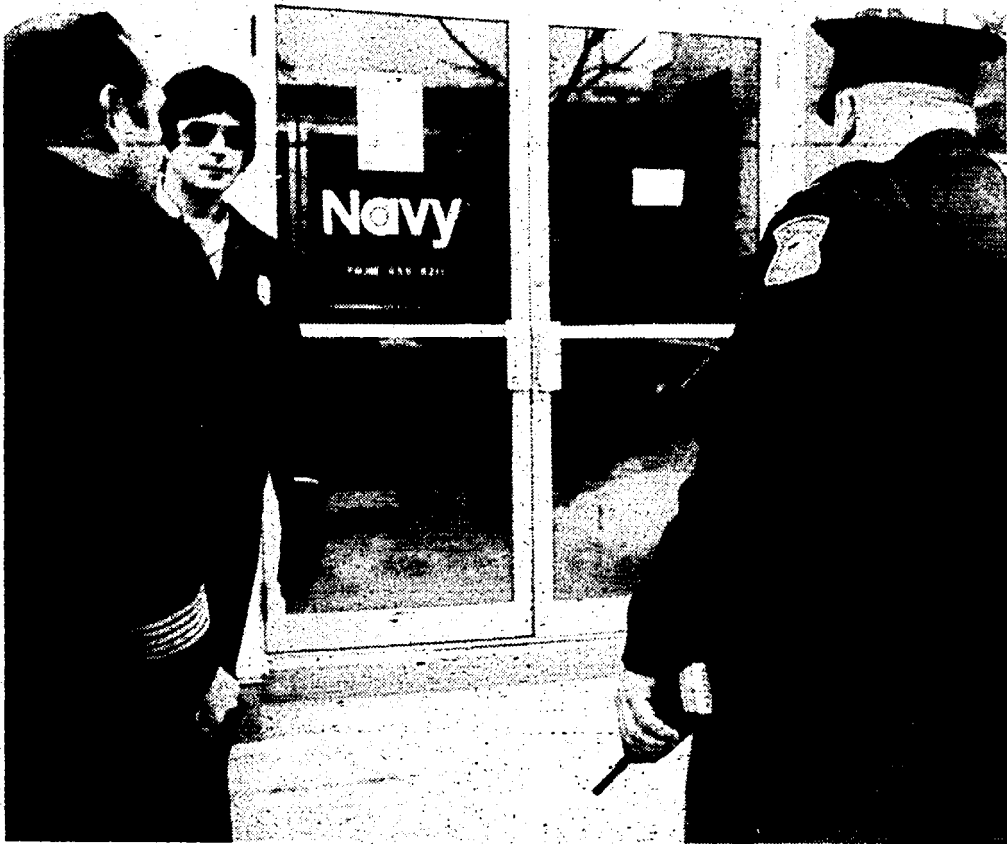

INSPECTING THE bombing scene shortly after the explosion in the Navy recruiting office Monday are, from left, Plymouth Fire Chief Roy Hall, Fire Captain Robert Degen, and Police Lt. Henry Berghoff. (Crier photo by Robert Cameron)

During holidays *Crier to publish Mondays*

The Community Crier will be published on Monday Dec. 22 and Monday, Dec. 29 during the Christmas holidays.

This change from the regular Wednesday publication will enable carriers and The Crier staff to celebrate Christmas Eve and Christmas Day with their families and friends and to finally finish their Christmas shopping.

As a result, the display advertising deadline for the Monday, Dec. 22 edition will be Friday, Dec. 19 at noon. The ad deadline for the Monday, Dec. 29 issue of The Crier will be at noon, Friday, Dec. 26.

Classified ad deadlines for Dec. 22's issue will be Friday, Dec. 19 at 5 p.m. and for Dec. 29's edition at 5 p.m., Friday, Dec. 26.

Crier offices, at 1226 S. Main St., Plymouth, will be closed Christmas Eve and Christmas, Dec. 24-25. They will reopen Friday, Dec. 26 at 9 a.m. The newspaper's offices will also be closed New Year's Eve Day and New Year's Day, Dec. 31-Jan. 1, and will reopen Friday, Jan. 2 at 9 a.m.

Included in the Monday, Dec. 29 edition of The Crier will be a special section on Growth in The Plymouth-Canton Community.

Carriers are reminded that their collections are due Saturday, Dec. 27 from 10 a.m. to 2 p.m.

BY CHAS CHILD
A Canton woman ignited a homemade bomb in the foyer of the Naval Recruiting Station in downtown Plymouth Monday morning.

No one was hurt when the homemade device, contained in a glass jar, exploded at 9:15 a.m. at the Navy office, 819 Penniman Ave.

Arrested and charged with setting an explosion with intent to destroy was Eileen Anita Roths, 50, of 39743 Hillary, Canton. She was arraigned on the felony charge yesterday in 35th District Court.

A recruiter at the Navy office, Petty Officer Patrick Lambert, said he was waiting in the foyer of the station when the suspect approached with "a glass quart jar."

"She opened the first door (of the foyer) and said, 'Please stand aside, I have a present for my son,'" said Lambert. "She then placed the jar down, lit the fuse, and left. She seemed quite calm."

Lambert and another recruiter then left the foyer and immediately the bomb went

off, he said. Black powder "probably" served as the explosive for the bomb, which was filled with rifle cartridges and other objects, said Plymouth Police Chief Timothy Ford.

Because a glass jar was used to hold the charge, it did not build up much explosive force, added Ford. A glass pane in the foyer was cracked, but this was the only damage, he said.

Lambert said he tried to detain the suspect after the bomb exploded, but she had entered her car and locked the doors. "I got the license plate number, though, and called the police," he said.

Using this information, Canton police arrested Roths in the township shortly afterward around 10 a.m.

Roths' son, whose name was not released by the head of the recruiting office, had contacted the Navy about a year ago requesting information. Since then, said Mike Richardson, chief of the Plymouth Navy recruiting office, he had been contacted twice, but both times he said he was not interested in enlisting.

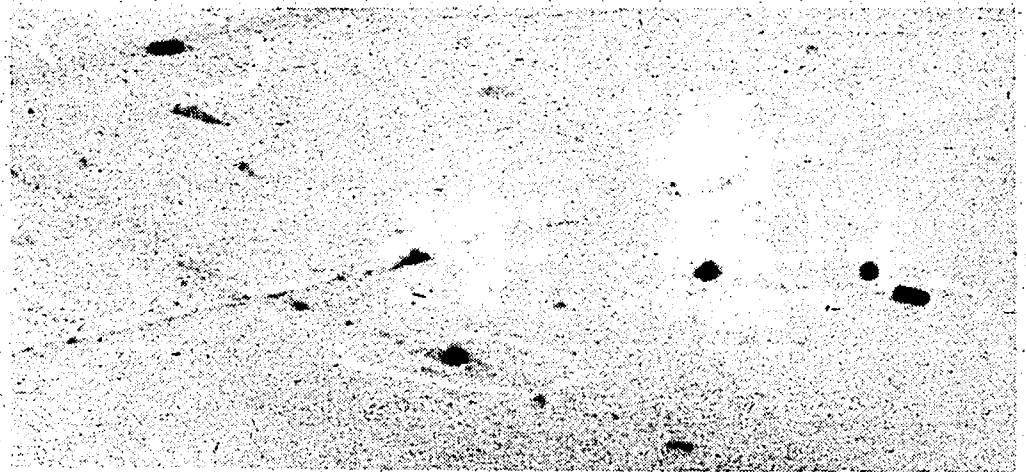

SHRAPNEL FROM the bomb, including bullets and musket balls, were scattered on the sidewalk of Penniman Avenue. Police circled the debris for investigative purposes. (Crier photo by Robert Cameron)

Plymouth on TV Jan. 6

"Word of Honor," the made-for-TV movie filmed in Plymouth mid-September, will be aired Tuesday, Jan. 6 at 9 p.m. on Channel 2 (CBS).

Produced by Alex Karras and Susan Clark, his wife, the movie starred Karl Malden. The veteran actor portrayed a reporter waging a battle to keep his sources secret during a murder trail.

Many local residents crowded around Kellogg Park in Plymouth during the filming and will appear in some of the movie scenes.

Culbert outspends rival in losing re-election bid

BY CHAS CHILD

Former Canton Supervisor Noel Culbert outspent his victorious opponent more than 2-1 in the recent general election.

Campaign financial records filed last week show Culbert received \$4,260 from various sources, while winner James Poole listed contributions of \$1,963, all from one source, himself.

Culbert also outspent everyone in the races for treasurer, clerk, and trustee. Robert Padgett, top vote-getter in the trustee campaign, received \$1,935, highest of the eight trustee candidates. Steve Larson, also elected, listed contributions of \$1,246.18.

Loren Bennett, another trustee winner, received contributions of \$1,242. Gary Roberts, defeated in the eight-person contest, had contributions of \$1,199. And incumbent Carol Bodenmiller, a winner, listed campaign receipts of \$325 for the general election. Larry Bowerman, a loser, received \$974. Mary Dingeldey also filed a statement, but did not list a figure of total contributions.

The rest of the candidates, including the two seeking the treasurer position, Maria Falkiewicz and James Kearney, declared they spent under \$500, and therefore were not required by state law to file a detailed campaign financial statement.

About 30 per cent -- \$1,300 --- of Culbert's war chest, the candidate contributed himself. This does not include a loan of \$748.15 that Culbert made to his campaign, according to the statement, on file at the Wayne County Clerk's office.

The financial statement, due Dec. 4, covered the period starting 11 days before the Nov. 4 election.

Other contributors to the Culbert campaign include a number of persons who do business with the township. Robert Wade and Donald Trim, for example, each gave \$100. They head Wade, Trim & Associates, the township's planning consulting firm.

Also, C. Gerald Hemming and Chris Polaczyk, two township attorneys, contributed \$100 apiece.

Twp. campaign funds revealed

BY CHAS CHILD

Candidates for office in Plymouth Township couldn't be accused of being big spenders, compared to their counterparts in Canton Township.

According to campaign financial statements filed last week, Supervisor Maurice Breen received a total of \$340 and spent \$1,316.94 during the recent election campaign.

The statements, filed with the Wayne County Clerk, covered the period from 11 days before the Nov. 4 election through Dec. 4.

Breen listed one contributor, Leo Calhoun, of Plymouth, who donated \$300. Breen earlier had loaned his campaign \$3,000, the statement said.

The supervisor's opponent, Democrat Carol Levitte, spent or received less than \$500 on her campaign, and therefore was not required to file a detailed financial statement.

No other township candidate spent or received more than \$500 during the filing period either.

An organization called the Canton Democratic Committee contributed \$150. Its address is the same as Culbert's home address, 1706 Woodbridge Ct.

State Sen. William Faust, of Westland, gave \$50 to the Culbert campaign. Others contributing include: James Haverstick, of Westland, \$150; Joseph McClain, of Detroit, \$100; Jim Folger, of Canton, \$50. Kenneth Morris, of Livonia, is listed as loaning the campaign \$1,100.

Padgett received campaign funds from the following persons: Ken Dividock, Canton, \$25; Stanley Gill, \$25; Frank McMurray, Canton, \$20; and Howard Stien, Jr., Wayne, \$25. Padgett loaned his campaign \$1,000, the statement said.

Larson listed three contributors: C. Gerald Hemming, \$75; Sanford Pearlman, of Southfield, \$50; Abe Green, of Farmington, \$50. Larson loaned his campaign \$70.

Roberts had a number of contributors. They are: Claude Howard, of Westland, \$94.80; Prehlad Vacher, M.D., of Canton, \$94.80; Tim Murphy, of Canton, \$50; Sam Zeer, of Southfield, \$100; Sanford Pearlman, of Southfield, \$50; Milton Rotenberg, of Birmingham, \$50; James Haverstick, of Westland, \$100; Al Rosen, of Dearborn,

Cont. on pg. 6

It's time to send our FTD
Holiday Glow[®]
Bouquet



Brighten up the season. With our festive arrangement of fresh flowers and greens in an exclusive FTD Snowflake Hurricane Lamp. Call or visit us now.

heide's
flowers
453-5140

Harvey at Ann Arbor Trail



Helping you say it right.

State nixes Twp.'s bid for cityhood

It looks like the City of Plymouth Place will never be established.

Thursday, the state Boundary Commission rejected petitions, filed by Plymouth Township residents in 1977, seeking incorporation into a home-rule city. They were a political maneuver to block annexation attempts by the City of Plymouth.

The petitions were rejected because they contained errors in their legal descriptions, said Jim Hyde, executive secretary of the state Boundary Commission.

"If the petitioners are still interested (in becoming a city), then they must be refiled with correct legal descriptions," he said. The property outlined in the original petitions matches the township's current borders.

Thursday's ruling marks the end of the six-year old struggle between the city and township over annexation.

In 1974, the city filed three petitions to annex the Hillside Inn property, Burroughs parking lot, and all of Plymouth Township. In January, a circuit court judge ruled that the Burroughs lot would remain part of Plymouth Township. Following that decision, the city dropped its annexation drive and the

petition for the Hillside Inn property was ruled inactive.

These actions paved the way for the Boundary Commission to rule on the petitions favoring home-rule city, to be called Plymouth Place.

Burroughs announces layoffs

Effective Dec. 12, 222 employees of the Burroughs plant in Plymouth were laid off due to the results of a competitive market, company-wide consolidation and the natural evolution of the electronics industry. The plant is one of two world-wide that handles final assembly of the company's B-90 computer.

Company spokesmen said the layoffs "are in the indefinite category, which means it is unclear how long it will be." Employees will be compensated for the holiday period, however. The spokesman explained the layoffs were plant-wide and reductions were made in every department.

"The company is in the process of several major moves, including consolidation of plants, closing of small overseas market operations and an attempt to get the cost of our product down to a competitive level," the spokesman said. "A very important factor to consider is because of the competitive market, we have to look for ways to make the product better and less expensive. The nature of the industry is that new models have less parts and are less labor-involved."

He explained that an older Burroughs accounting machine, for example, had more than 20,000 parts, while a newer machine has less than 3,500.

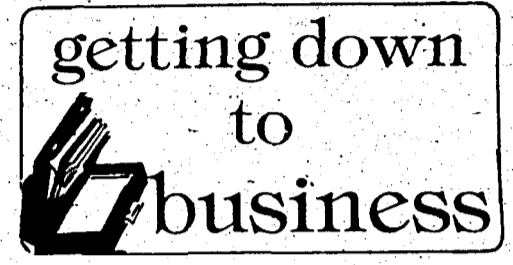

The layoffs are part of a company-wide reduction of about 1,400 workers, about six per cent of the total Burroughs work force, said a spokesman. Plymouth's plant employed about 1,600 workers before the layoffs, he said.

Dock Duncan, a spokesman for United Auto Workers Local 1313, which represents Burroughs workers in Plymouth, disagreed with the size of the company's local employee reduction. "What we were told by the company was that approximately 350 people would be laid off," he said. "We're not happy, but there's nothing we can do about it."

Duncan said the laid off workers would be paid for eight days over the holidays, and then be eligible for unemployment and sub pay. "It sure came at a bad time," he added.

The Community Crier

USPS 304-150
Published each Weds.
at 1226 S. Main St.
Plymouth, Mich. 48170
Carrier delivered: \$10 per year
Mail delivered \$16 per year.
(Mailed at Controlled Circulation rates, Plymouth, Mich. 48170)
Call 453-6900 for delivery.

The Crier's advertisers strive to honestly present commercial messages to our readers. If, for any reason, you find problems with a Crier ad, please call our office at 453-6900.

Crier advertising is published in accordance with those policies spelled out on the current rate card, which is available during business hours from our office at 1226 S. Main St., Plymouth. An advertiser's final acceptance by the publisher is conditioned only upon its publication.

We Pay CASH for Class rings & Wedding Bands

Coin Galleries is Wayne
Country's largest Gold & Silver reclamation company with professional buyers in three cities. We are always the top buyer.

The prices listed to the right are a guide based on \$652.00 per oz. Gold. With Gold fluctuating \$590.00-\$650.00 per oz. our buying price will range 10K \$6.00 to \$7.00 per gram & 14K \$7.50 to \$9.00 per gram

CAVEAT—See Us Last—Beware of Those Who Advertise High Newspaper Prices and Then Will Not or Cannot Pay Them—Many Ladies Class Rings Weigh Less than 8 grams.

Prices Subject to Market

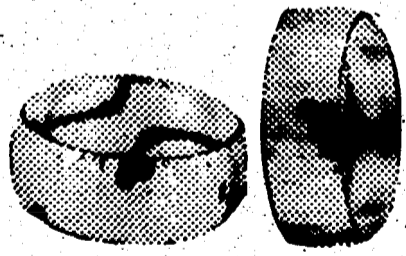

CLASS RINGS & HEAVY RINGS

	10K	14K	18K
Mini-Ring (8 Grams) (5.1 DWT)	\$80.00	\$68.00	\$52.00
Small Ring (12 Grams) (7.7 DWT)	120.00	102.00	78.00
Medium Ring (18 Grams) (11.6 DWT)	180.00	153.00	117.00
Large Ring (24 Grams) (15.4 DWT)	240.00	204.00	156.00
Ex. Lge. Ring (30 Grams) (19.3 DWT)	300.00	255.00	195.00
Jumbo Ring (36 Grams) (23.0)	360.00	306.00	234.00
Heavy Jumbo (44 Grams) (28.0 DWT)	440.00	374.00	308.00

WEDDING BANDS & LIGHT RINGS

	10K	14K	18K
Mini-Ring (3 Grams) (1.9 DWT)	\$30.00	\$25.50	\$19.50
Small Ring (5.5 Grams) (3.5 DWT)	55.00	46.75	35.75
Medium Ring (7.5 Grams) (4.8 DWT)	75.00	63.75	48.75
Large Ring (10.5 Grams) (6.7 DWT)	105.00	89.25	68.25
Ex. Lge. Ring (13 Grams) (8.4 DWT)	130.00	110.50	84.50
Jumbo (16 Grams) (10.0 DWT)	176.00	136.00	104.00

Based on \$625/oz. Gold

DIAMONDS WANTED

POCKET WATCHES WANTED

REDFORD COIN GALLERIES
25004 8 MILE
1 BLK. W. OF BEECH
DALY ON NORTH SIDE
REDFORD TOWNSHIP
DAILY 10-6 SAT. 10-4
CLOSED SUNDAY 255-9660

INVESTMENT JEWELRY & PRECIOUS METALS
6848 ALLEN RD.
(Ecorse Rd.)
3 blocks W. of Southfield
ALLEN PARK
Daily 10:30-5 — Sat. 11-3
Closed Sun. 388-5100

Plymouth Coin Gallery
839 Penniman
across from the Post Office
W. of Main
Plymouth 459-6855
Daily 10:30-5 Saturday 11-3
Closed Sunday

BUYING.
U.S. SILVER COINS 1964 & BEFORE
DOLLARS VG.....\$14.00 to \$25.00
HALVES \$5.10 to \$7.50
QUARTERS..... \$2.60 to \$3.75
DIMES..... \$1.02 to \$1.50

STERLING SILVER \$11.00 to \$26.00
WAR NICKLES 1942-5... 50¢ to 85¢

Morrison, Stanwood & Polak, P.C.

are back downtown in our renovated offices at
823 Penniman Avenue

and
We're
glad to
be here!



Dec. 5, 1980



Feb. 16, 1980

Thank you for your
patience during our
temporary stay at
Joy Rd.

William J. Morrison, Jr.
Jean C. Stanwood
Stanley W. Polak
and Staff

Venith Dauderman
Luann Garchow
Dave Hardy
Gerry Hillard
Carol Rice

Roger Thurston
Renee Welton
Gordon Shaw
Bill Robinson
Avis Truax

WSDP airs holiday songs, interviews with Santa

'Tis the season to be jolly -- and so the songs of Christmas proclaim the joy of this season. If you already have the Christmas spirit or are looking for ways to perk up your spirit, WSDP at 88.1 FM has an entertaining day of Christmas programming on Dec. 19.

Especially for children, WSDP will air "Silver Spurs: A Christmas Story." The story

is about Silver Spurs, a fairy who helps Santa Claus with his Christmas duties.

Also broadcasted will be an interview with Santa which children will be interested in, aired at 12:20 p.m. and 4:54 p.m., respectively.

For the whole family, WSDP offers a selection of programs on Christmas travel.

Three programs, "Christmas in Switzerland" -- aired at 12:30 p.m., "Christmas in France" -- aired at 5:30 p.m. and "Christ-

mas in New Zealand" -- aired at 7:30 p.m. will cover the Christmas customs, traditions, and cultures in these lands.

Sign up to vote by Tuesday

To vote in the upcoming Thursday, Jan. 22 election, you must register to vote by Tuesday, Dec. 23. The Plymouth-Canton schools are seeking a 6.5 mills renewal on the ballot.

You can register to vote if: you are a U.S. citizen; are at least 18 years old by the date of the election; you are a Plymouth-Canton resident; and, you register at least 30 days before the election.

Absentee ballots will be available, beginning late this week, said Bernice Nichols, election spokesperson. Also, the school district office, 455 S. Harvey St., Plymouth, will be open Saturday, Jan. 17 for absentee voting. They will also be available until 2 p.m., Wednesday, Jan. 21.

For more information, call Nichols, 453-0200, ext. 422.

Pols' contributors listed

Cont. from pg. 3

\$100; L. Gould, of Plymouth, \$50; and Abe Green, of Farmington, \$50. Roberts also contributed \$475.

Bodenmiller listed these contributors: C. Gerald Hemming, \$100 and Chris Polaczyk \$100. She also loaned \$300 to her campaign.

Bowerman's only contribution was from

himself, of \$162.85.

Dingeldey listed three contributors: Philip Dingeldey, of Canton, \$30; Dr. S. Levin, of Southfield, \$100; Jack Street, of Canton, \$50; Hayes Wilson, of Farmington, \$10; Jack Doheny, of Northville, \$10; Stan Denski, of Canton, \$50; and Joyce Chumbley, of Canton, \$30.

REMEMBER
Every Tuesday
is
CASE BEER
SALE
(LOWEST KEG BEER PRICES AROUND)

CIGARETTES
2 carton limit
\$4.99 reg. + Tax **\$5.99** 100's + Tax
Expires 12/31/80

WINE SALE
Every Thursday
10% off Bottles 15% off Case

Package Liquor-Keg Beer-Wine

Pepsi
Mountain Dew
Diet Pepsi
\$1.89
+ dep.
8 pk. ½ Liter
Expires 12/31/80

Canada Dry
Mixers
4/\$2.00
(excluding Tonic
and Bitter Lemon)
Expires 12/31/80

Perrier
99¢
+ dep.
Expires 12/31/80

CRACKER BARREL
PARTY STORE
41741 Ford Rd.

Mon.-Sat. 9 to 11 p.m.
Sun. 12 to 7 p.m.

981-0899



Hours
Mon. thru Fri. 9-12 & 3-8
Saturday 10-6

Chase Chiropractic Office, Inc.
190 PLYMOUTH ROAD
PLYMOUTH, MICHIGAN 48170

Dr. Richard Chase, D.C. PHONE 455-3593
Dr. Fred Lange, D.C. 455-3821

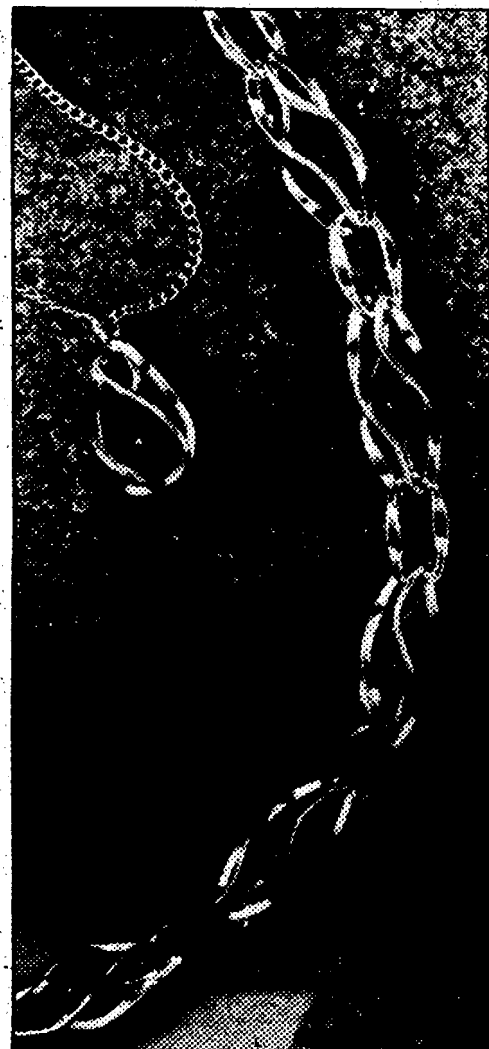

Genuine Jade: The beauty of jade is captured in this fine jewelry of 14Kt. gold overlay by Krementz. Matching earrings are available.

Beitner's 
fine jewelry

904 W. Ann Arbor Trail
453-2715
Mon.-Thurs. 9-6, Fri. 9-9, Sat. 9-6

Krementz

Children OK after accident

The four Farmington Hills children injured in last Tuesday's fatal accident have all been released from hospitals, according to spokespersons.

Killed in the accident was Katherine M. Lampinen, 28. It occurred on Haggerty Road near Plymouth Road about noon last Tuesday.

Paul, 10, and Timothy, four, were discharged last Wednesday, said a St. Mary Hospital spokesperson. Six-week old Amy Lampinen was treated and released after the accident, she added.

Seven-year old Joseph Lampinen was transferred to Detroit Children's Hospital and then released on Saturday, said a hospital spokesperson.



addenda & errata

In the Dec. 10 edition of The Crier, it was erroneously reported that Loren Bennett has replaced Robert Padget on the Canton Planning Commission. Bennett has filled Carol Bodenmiller's slot on the Planning Commission.

One elementary school on the Extended School Year (ESY) calendar, Isbister, is located in Plymouth Township. Last week's story on ESY incorrectly reported that all six elementaries on ESY were in Canton Township.

Jolly The Miller

invites you and your guest . . . to enjoy one complimentary dinner when a second dinner of equal or greater value is purchased.

Valid Sunday through Thursday evenings.

You must bring this ad. Cash only.

Expires Dec. 24, 1980

Plymouth Hilton Inn

5 Mile & Northville Roads
Plymouth, Michigan 48170
Call (313) 459-4500

PC

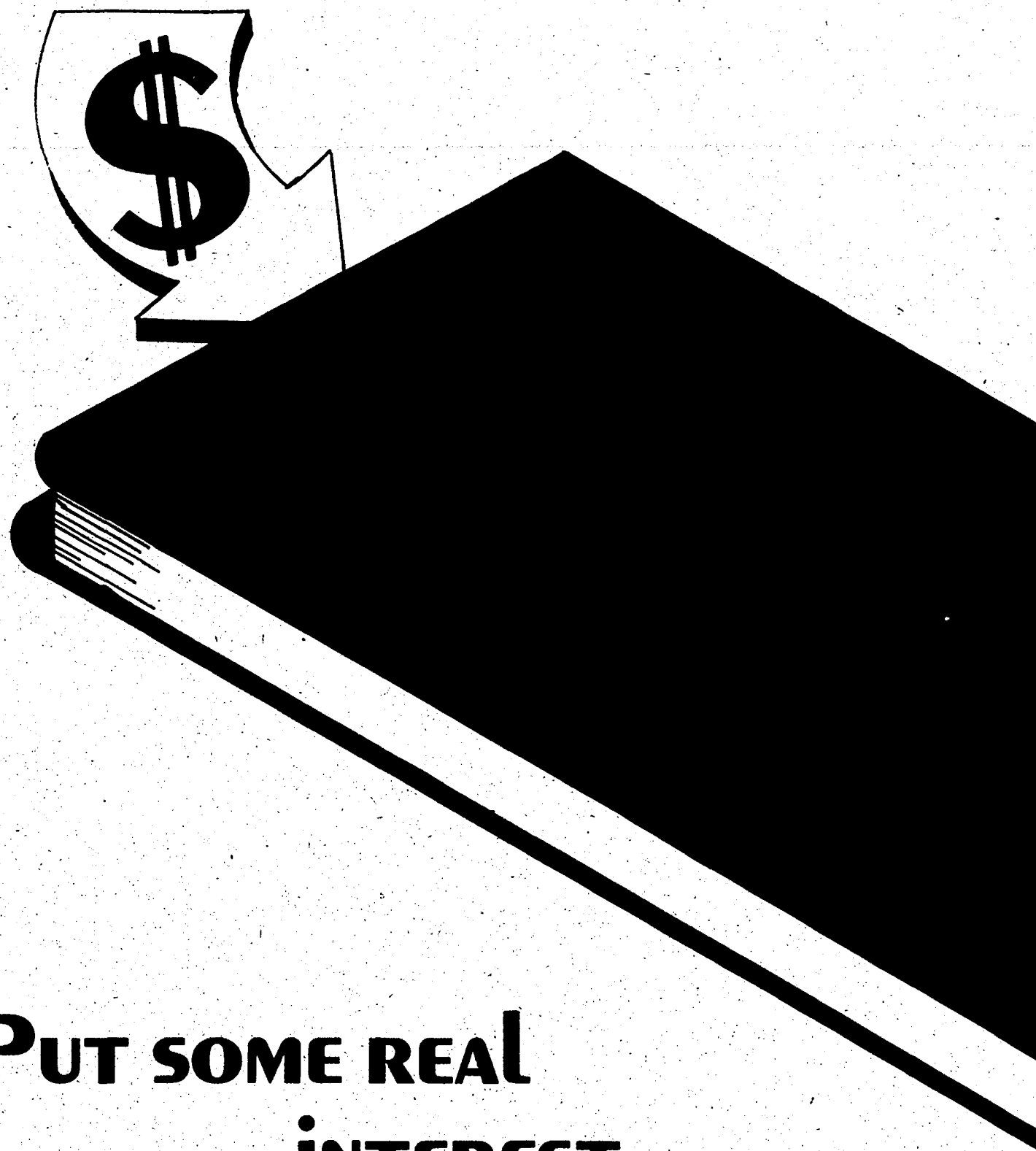

PUT SOME REAL INTEREST IN YOUR CHECKING

On January 2, 1981 WAYNE BANK will offer a new kind of savings account. It will look like a checking account with one big difference: It will earn interest like a savings account. It's called a NOW account. There are a few things you will need to know. So let one of our account representatives explain our new "WAYNE BANK-NOW" account to you. We're the experts on checking because we're a Full Service Bank, and Full Service Banks invented checking. The professionals at WAYNE BANK are ready to show you how to get interest on your checking. We've got the answers.

WAYNE BANK



Hours: Mon-Thurs 9 am-4 pm
Friday 9 am-7 pm
Saturday 9 am-12 noon

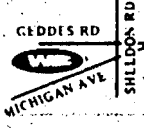

SHELDON OFFICE
Michigan at Sheldon
Canton
397-1150

MAIN OFFICE
35215 Park at Biddle
Wayne
721-4151

FORD & HAGGERTY OFFICE
Canton
455-5900



ESY calender has not disrupted our family life

EDITOR:

On the front page of your paper on Dec. 10, there appeared an article titled "Bird, Farrand parents sign Anti-ESY petitions." As a parent of three sons who know little other than ESY, this article caused me much mental upheaval and anguish.

I do not believe that ESY has greatly disrupted our family life nor has it destroyed our family integrity.

The disruptions come, for the most part, from others in the community not aware or not accepting the fact that there are young people in the community on an Extended School Year (ESY) and not providing for these students. (My sons have had to accept inferior, overcrowded lessons in tennis and swimming to name just two areas).

Also, I would like to know why Meredith Padden

and the homeowners in Farrand and Bird school areas, did not speak out before, when other schools were forced to accept this method of schooling that is so objectionable to them now.

Mrs. Padden's statements say to me that her family and neighbors are somehow more important than all those families now on ESY; that the value of properties in the Bird and Farrand areas is more important than the value of those in Canton township, and that her being free to "work or go to school" is more important than the education of our young people. Maybe it is time for the rest of the community to "jive" with our school system during its stressful times.

Furthermore, I do not feel that ESY is "an infringement of our rights."

It is the responsibility of every citizen of Plymouth-

Canton to provide an education for our young people. If that means some problems to be worked out by parents then so-be-it.

The problems of ESY are not insurmountable.

An ESY or mixed schedule is not easy. There are problems for all families. Many or most who are now effected by ESY do not like it and did not choose it, but ESY could be a little less terrible if we all work together toward the same goals for all our students and not toward the convenience of some of the parents.

Let's start looking at the pluses not the minuses.

Three weeks vacation during the fall or spring can really be a learning, sharing family experience even if four and one half weeks after Christmas is somewhat less appealing.

MARILYN SCHWINN

A Plymouth Township ESY Parent

W. EDWARD
WENDOVER

With Malice Toward None



The most pathetic display of foolishness comes from those who are convinced that they're superior to others and ought to be treated accordingly.

Unfortunately for those deluded souls, whatever standard they're using (which subdivision they live in, how many cars they have, how much they make, etc.) rarely stands up under close examination.

And even when it does, what right does it give them?

The Plymouth-Canton School Board has fostered these delusions of superiority in subtle ways over the years and is once again embroiled in a controversy of its own creation as a result.

The real and imagined differences parents find between schools and school programs can be traced far into history:

- From the start of the Centennial Education Park, naming high schools after various communities was an error. Better to have honored former school superintendents or educators.

- When the school board handed the oldest traditions all to Salem, it ignored the need for other CEP high schools to find their identity and nurtured imagined superiority.

- When the school board woke to the disparity in school attendance areas (which even used railroad tracks as dividing lines), it created a citizens' committee that gave recommendations later changed because superior-feeling parents pressured the board. (Elitist Bird School parents in one area, for instance, argued successfully against being moved to another "inferior" school despite the rising Bird School population.) Rather than face a citizen committee's suggestions, the board now uses a computer system to draw up school attendance areas.

- When the school board built new elementary schools -- all in Canton -- and staffed

them with newly-promoted administrators instead of seasoned veterans, it created a real disparity.

- When the school board implemented 45-15 in some schools and not others, it created real problems for families on mixed schedules and gave added fuel to those who imagined that they were better (or worse) than the others.

Had the school board put all Plymouth-Canton elementary and middle schools on the same year-round schedule, we might have had smaller class levels, less need for new schools, more successful bond and operating millage tries, and -- most importantly -- more equitable educational opportunities for all students in the district, regardless of socio-economic status.

Since democracy relies on the type of participation now being seen from Bird and Farrand School parents, they cannot be faulted for making their voices heard. They can, however, be warned of the folly in claiming they're any better than anyone else and thereby entitled to something different.

And the school board must once again be aware that allowing the dreamers' misbeliefs to continue only puts the problem off for another day. If the board members give in to the concerns raised by the Bird and Farrand parents (fathers should be particularly incensed by the ridiculous sexist claim that ESY is a "women's issue.") how they can look a Canton parent straight in the eye?

The ESY program is different, yes. But it is not a bad approach towards burgeoning growth in schools.

It may take some adjustment to get used to the year-round and 45-15 aspects, but those adjustments can be made by everyone, no matter which side of the tracks they're from.



ESY 'doesn't feel right'

EDITOR:

It was very gratifying to read of other parents' objections to the impending adoption of the ESY calendar at their respective schools. I was beginning to fear that I was the only parent who felt any degree of alarm over the consequences of this new program.

In the fall of 1981, when Fiegel School begins its ESY program, my two young sons will be five and seven years old. It's a rare mother who can look forward to the prospect of being confined with two very young and active boys for three weeks at a time in the dead of winter.

Added to this particular dread, I can't help but feel a twinge of sadness in knowing that my nature-loving sons will be missing

a major portion of those wonderful summers when toad-hunting season is in full swing and days seem meant for virtually living in their bathing suits.

ESY just doesn't seem natural. It doesn't feel right. I'm against it!

NANCY WALLS SMITH



New resident loves Plymouth

EDITOR:

Despite several serious adversities that have occurred during 1980, a nice thing that happened was becoming a resident of Plymouth.

Each of us have unpleasant situations which happen from time-to-time, but this time of year I wonder if sufficient time is devoted to the blessings we possess. And the good things that have happened to us.

We each reflect in our own way -- and let's forget material things. In my instance, I have a new spirit, good health, new acquaintances and friends, and a peace of mind plus this is one of the nicest, most peaceful communities in which I have lived.

The Plymouth Police have the city so very

much under control. The retailers and merchants have such a variety of goods and services to please all. And such neat, clean, tidy places in which to shop.

Plymouth is warm, comfortable, secure and so friendly. I'm so fortunate to be part of the community. It's been seven months now that I've been a resident. I'll maintain the "booster" stage and advance to being a "working resident." That is, join an organization or two that contributes to the relationship Plymouth has extended to me.

I've ample to be thankful for during the Christmas season and I sincerely hope you feel the same. And to think that my thanks involves nothing -- isn't that great?

JACK DEMPSEY

Community

The Crier

THE NEWSPAPER WITH ITS HEART IN THE
PLYMOUTH-CANTON COMMUNITY

1226 S. Main St. Plymouth, Mich. 48170 (313) 453-6900

W. Edward Wendover, publisher; Chas Child, editor; Patricia Bartold, managing editor; Dan Bodene, reporter; Robert Cameron, photo editor; Phyllis Redfern, office manager; Ken Voyles, sport editor; Charlie Yerkes, cartoonist; Mike Carne, advertising & art director; Fran Hennings, Tina Jones, Bill Disenroth, Sallie Roby, and Vicky Downing, advertising consultants; Jackie Pack, business manager; Joyce Drewry, circulation manager; Joanna Darwish, asst. production mgr.; Karen Sanchez, typesetter; Nancy Hayes, graphic artist.

PUBLISHED EACH WEDNESDAY
by Plymouth-Canton Community Crier, Inc.

Carrier Delivered: 85¢ monthly; \$10 yearly.
Mail Delivered: \$16 yearly in U.S.A.



Recycle Your
Newspapers

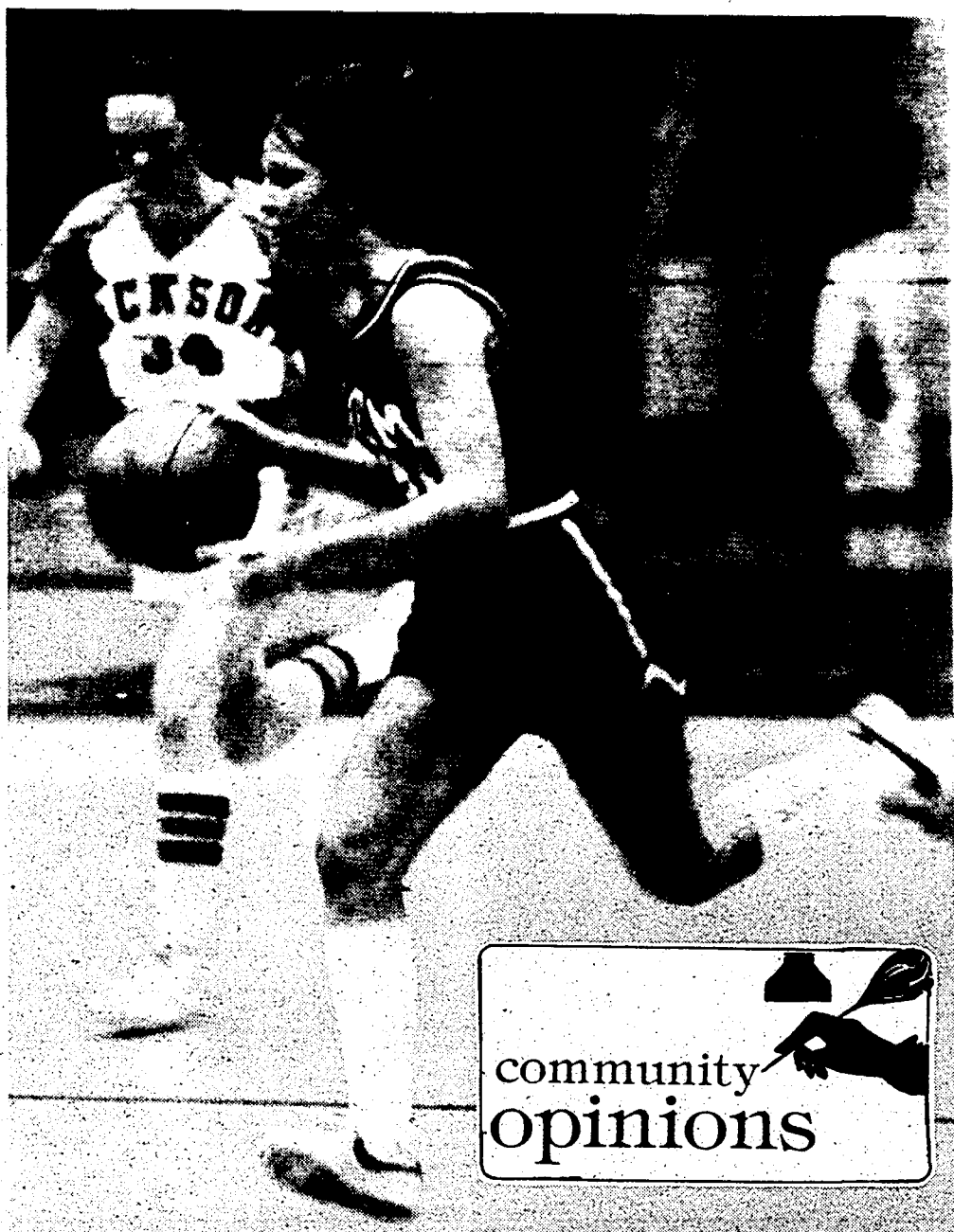

community
opinions

EILEEN MOORE of the Salem Rocks concentrates as she drives toward the hoop during the girls' semi-finals basketball tourney in Lansing Friday. Congratulations Rocks on your excellent performance this year. THE COMMUNITY CRIER. (Crier photo by Robert Cameron)

We are proud of Rocks

Please turn to page 47.

The message you'll find there comes compliments of the Jackson High School Vikings -- the girls team which defeated the Salem Rocks in the girls' state basketball semifinals in Lansing Friday -- and the Jackson Citizen Patriot, the daily newspaper in Jackson.

(The Crier is printed at the Citizen Patriot.)

The day before our team was headed to the state semifinals, The Crier bet the Jackson newspaper a full page congratulatory advertisement on the game's outcome.

Following the Viking victory, the Citizen Patriot prepared and provided the ad appearing on page 47.

We at The Crier are proud we backed the Rocks. Their success this year, their abilities and the sportsmanship they displayed, are a credit to The Plymouth-Canton Community.

Congratulations ladies! Go Rocks.

THE COMMUNITY CRIER

Voters, learn school issues

Plymouth-Canton school officials are considering asking voters to approve a \$1.9 to \$2.5 million bond issue in a special

Fund thanks givers

Once again, residents have demonstrated their support and long-standing commitment to the Plymouth Community Fund Drive by helping it exceed its \$318,000 goal this year.

This generosity shows that, even though money is tight these days, contributors are willing to continue their support of the many worthwhile groups which are funded through the annual drive.

Extend your thanks to all the volunteers who contributed their time, skills, and enthusiasm to the Fund Drive this year. They help make our community work.

THE COMMUNITY CRIER

election, to be held either in March or June.

Funds would be used to: equip schools for year-round classes next fall; purchase furniture and books for Lowell Junior High School, which the district will rent from Livonia next fall; and, buy portable classrooms as needed throughout the district.

Last year, voters defeated two bond proposals at the polls. In March, a \$21.9 million bond issue was shot down and in June an \$11 million issue met defeat.

School officials, pressed for money to finance grade realignment, should begin now to tell voters why more money is needed, if the school board decides to put a bond proposal on the ballot.

Voter education is a tough task. But, unless taxpayers understand school financing, the outcome of a third attempt at a bond proposal can almost be forecasted.

THE COMMUNITY CRIER

★ Christmas Trees ★ Fresh Cut JUST LAST WEEK in the Upper Penninsula

Grade A
Blue Ribbon
Winner Spruce
\$12 to \$15

Open 3 p.m.-7 p.m. Daily
Ann Arbor Road
at Main
Plymouth



Give them a Golden Christmas with

ROMAN

Custom Personalized

JEWELRY

The personal gift for
everyone on your list.



For Mom Aunt Sue

For Brother That Special Guy

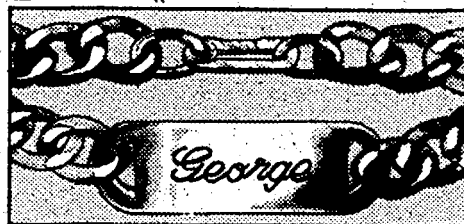

2839 Bracelet—Men's I.D.
\$10.00

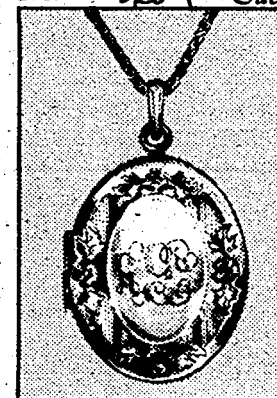

5463 Locket 24"
\$14.50

For Teacher-Secretary

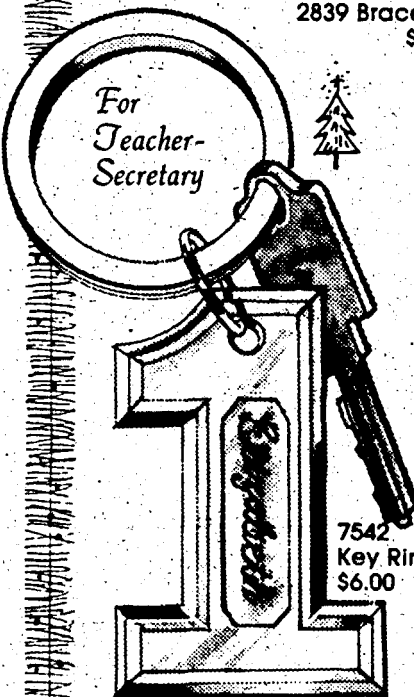

7542
Key Ring
\$6.00

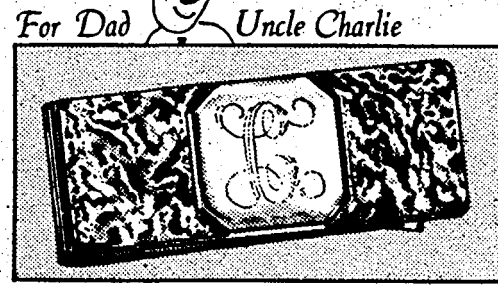

8562 Money Clip \$10.00

For Sister / That Special Girl



3729 Necklace 15 1/2" \$8.50

For Babysitter / Friend



8551 Jean Tag 21\$5.00 \$3 each

ENGRAVED FREE
while you shop

JEWELRY IS ACTUAL SIZE

Engraving Connection

(313) 459-3180

470 FOREST AVENUE

IN THE FOREST PLACE MALL • PLYMOUTH, MICHIGAN 48170

friends & neighbors

VPOs help the community as well as the courts

BY DAN BODENE

Probation officer. The words bring to mind a person who watches every move of the probationer, criticizing, evaluating, passing judgment.

But the image doesn't fit the reality. Most probation officers, especially the volunteers, seek only to help and never to judge or criticize.

In fact, most of the probation officers in the 35th District Court are volunteers, people who give their time to try to do something for someone else. Recently, these volunteer probation officers (VPOs) were recognized for their work at a dinner hosted by the court, a tribute to the service they perform that is not available in every court in the state. George Wiland, court administrator, summed up his feelings by saying, "I have come to realize how great you all are after spending time with other administrators. I offer my appreciation for the job you have all done."

The job VPOs do is not easy. More than 1,200 probation cases are spread between 14 assistant chief probation officers and 65 VPOs. The nature of the job requires individual attention to each probationer, and that requires a lot of time.

Scheduling is accomplished between the probationer, VPO and assistant chief. The VPO can ask for any number of cases, as long as her or she can handle the caseload. Most VPOs take on between one and five cases at a time, according to Wiland, but the number fluctuates because of the term of probation and what the conditions are.

"Some probationers complete a three-week alcohol awareness program and are released," says Wiland, "and some are required to meet with the VPO once a month for a year. It all depends on the judge."

Most of the cases assigned by Judge Dunbar Davis to Bob Olsen, a Plymouth resident, are those dealing with dope, traffic, alcohol and theft.

Olsen says the alcoholics are the toughest to rehabilitate. "With alcoholics, you're probably sunk from the beginning, but if you can get them involved in an Alcoholics Anonymous type of program, you might have a chance." Lee Nuttall, another VPO, agrees. "With the alcoholics, it's really frustrating -- you just can't get them to recognize they have a problem."

Probationers aren't the only ones with problems, however. Olsen says although most of his cases are first-time violators, the amount of paperwork to be done for each



BOB OLSEN, right, a volunteer probation worker in the Plymouth court office, receives a certificate from Don McDonald, an assistant chief probation officer, as Judges James Garber (far left) and Dunbar

Davis look on. VPOs from the 35th District Court probation offices in Canton, Plymouth and Northville were honored last week for their service to the court and the community. (Crier photo by Dan Bodene)

case is sometimes overwhelming.

"VPOs are responsible for collecting court costs, and there's paperwork in that," he says. "There are also reports on each individual, and notices to the judge if the parole is violated."

The work is not without its rewards. "I feel like I'm doing something, not just complaining," explains Nuttall. "It's a very satisfying thing," adds Olsen. His wife Phyllis, who shares many of the triumphs as well as the pitfalls of her husband's volunteer service, commented, "I guess if you can get to one out of 10 or even one out of 20, it's worth it."

Olsen "gets to" his cases with a unique method. "Every probation officer has a pattern," he explains. "Mine is to listen for two meetings -- just listen, and let the probationer do all the talking. Even if they don't want to say anything, that's all right, I listen anyway. On the third meeting, I talk."

Olsen, as well as other VPOs, develop their own techniques after a year-long training

program. During the initial year, VPOs keep in close contact with probation chiefs and assistant chiefs, but are free to handle their own cases.

Currently, the 35th District Court's probation department is understaffed. Wiland says Livonia's court, which handles nearly the same amount of probation cases, has a staff of 100 VPOs. "That number seems to work well, and that's what we're shooting for," he said.

Wiland adds that persons who want to volunteer their time as VPOs should contact him at the 35th District Court, which will soon undergo some changes in all departments.

Once the consolidated court facility is built, although the number of cases will probably not decline, the working conditions will improve greatly, Wiland says.

"We'll have four report rooms in the building, and an alcohol awareness classroom in the basement," said Wiland. "I fought hard for that basement when we were planning the building."

Until the new facility is built, VPOs will continue to work out of offices in three court locations -- in Canton, Plymouth and Northville, as well as wherever is mutually agreed between the VPO and probationer.

"It's a growing and changing department," observes Ron Phelps, chief probation officer. "The VPOs have been, and always will be, the backbone of it."

Judge James Garber agrees. "The court is people, and that's why ours is one of the best in Michigan, and always will be the best."

FELIZ NAVIDAD
from
Emma's Restaurant

Make
Reservations
for our
**Second Annual
MEXICAN FIESTA**
December 20
5:30-7:30-9:30
844 Penniman Ave.
Plymouth, Mi.
453-6260

Wiltse's
Community Pharmacy

Our Hours from
Now till Christmas

9 to 7 Mon., Tues., Wed.
9 to 9 Thursday & Friday
9 to 5 Saturday

453-4848
330 S. Main
Plymouth

HOME ST.

New address?
WELCOME WAGON®
can help you
feel at home.

Greeting new neighbors is a tradition
with WELCOME WAGON -- "America's
Neighborhood Tradition."

I'd like to visit you. To say "Hi" and
present gifts and greetings from com-
munity-minded businesses. I'll also present
invitations you can redeem for more gifts.
And it's all free.

A WELCOME WAGON visit is a special
treat to help you get settled and feeling
more "at home." A friendly get-together
is easy to arrange. Just call me.

356-7720
Welcome Wagon

**Brighten up Your
Gloomy Room**

With professional painting & design at a
special holiday rate. Call Now for more
information. **Michael Orman**
27675 Spring Valley
Farmington Hills, Mi.
476-3211

Treat Yourself
for the Holidays
with a
Complete Make-Over \$15
Demi \$7.50

Daytime or Evening wear
Marylou Block Cosmetics

**BEAUTIFUL PEOPLE
HAIR FORUM**
550 FOREST AVE.
PLYMOUTH, MI • 459-2880

18
tuesday

what's happening

To list your group's event in "What's Happening" merely send the information (in writing) to: THE COMMUNITY CRIER, 1226 S. Main St., Plymouth, Mich. 48170. Information received by NOON MONDAY will be used in that Wednesday's paper (space permitting.)

WRIGHT SETTLEMENT GIFTS

Employees of the Hillside Inn are collecting mittens, scarves, gloves and non-violent toys for the Franklin Wright Settlement House in Detroit, a home for youths age 13 and under. Gifts should have a note attached denoting age level, sex and a brief description of the gift. Please drop off gifts before Dec. 20. For more information, call 453-4300.

AGAWA CANYON SNOW TRAIN TOUR

Preparations are being made for an Agawa Canyon Snow Train Tour for three days and two nights, from Jan. 16 to 18. Cost is \$137 complete, and includes bus fare, lodging, meals and baggage handling in addition to the train tour. For more information, call Irene Murphy at 453-3379.

PLYMOUTH ENERGY PROGRAM

Infrared pictures of Plymouth homes will be available for viewing as part of the Plymouth Energy Program, for residents south of Ann Arbor Trail on Dec. 15 at the Plymouth Cultural Center, and for residents north of Ann Arbor Trail on Dec. 17 at West Middle School. Both meetings are held between 7:10 and 8:30 p.m. For more information, call 453-1234, ext. 54.

CORVETTE OWNERS

A new club for Corvette owners in the Plymouth-Canton area has been formed recently. For more information, contact Jason at 455-5783 or Denise at 459-2228.

CANTON CRICKETS

Canton Crickets, a preschool program for 3- and 4-year-olds, will meet Monday through Friday from 9:30 to 11:30 a.m. and Tuesday and Thursday from 1 to 3 p.m., from Jan. 5 through April 17. Cost is \$37.50 per 15 week, one day session per child. Limit is 15 children per class. Registration starts Dec. 2 at 8:30 a.m. at the Canton Parks and Recreation offices. For more information, call 397-1000.

ROCK AND MINERAL SOCIETY

The Plymouth Rock and Mineral Society will hold its 5th Annual Open House on Feb. 15 from noon to 5 p.m. at the Cultural Center, featuring demonstrations, movies, displays and sales. Cost is 50 cents for adults, 25 cents for children. For more information, call Dave Thomas at 453-7402.

CHRISTMAS PARTIES

Canton's Parks and Recreation Department is sponsoring its annual Christmas parties on Dec. 20 at the Recreation Center, Michigan Ave. at Sheldon. Parties will be held for kids ages three to seven from 9:30 to 10:30 a.m. and for kids ages eight to 12 from 10:45 to 11:45 a.m. Reservations can be made, by calling 397-1000.

STAMP CLUB CHRISTMAS PARTY

The West Suburban Stamp Club will hold its Christmas Party Dec. 19 beginning at 7 p.m. at the Central Middle School cafeteria. Bring a hot or cold dish to pass, and BYOB. For more information, call Carole at 464-2342 or Hal Williams at 464-9398.

CUB SCOUT PACK 1738

Cub Scout Pack 1738 will meet Dec. 17 at 7 p.m. in the Hulsing School gym, for the annual Christmas party.

SANTA'S SECRET WORKSHOP

Hulsing School's PTO is sponsoring a Santa's Secret Workshop, open to the public on Dec. 11 and 18 from 7 to 9 p.m. Approximately 80 gifts ranging in price from 5 cents to \$4 will be displayed. Elves will assist in secret gift selection.

GERMAN-AMERICAN CLUB

The German-American Club of Plymouth will hold its annual Christmas party on Dec. 21 at 2 p.m. in the Oddfellows Hall, 344 Elizabeth. Please bring a dish to pass.

CUB PACK 855

Cub Scout Pack 855 will meet Dec. 18 at 7:30 p.m. in the Field School gym for the monthly pack meeting and Christmas party.

FOCUS ON LIVING WITH CANCER

A Focus on Living with Cancer meeting will be held in the faculty lounge at St. Mary's Hospital, 36475 Five Mile Rd. Livonia on Wednesday, Dec. 17 at 7:30 p.m. The purpose of this self-help group is to bring together patients and family members who have questions or are experiencing problems as a result of living with cancer. For information, contact the American Cancer Society, 557-5353.

H.E.A.D. FITNESS WORKSHOP

Canton's Parks and Recreation Department is sponsoring a Health, Exercise, Appearance and Diet workshop for women on Jan. 17 from 9:30 a.m. to noon at the Recreation Center, Michigan Ave. at Sheldon. Cost is \$15 per person. For more information, call 397-1000.

CANTON CLASS OF 1975 -- REUNION

The 1975 Canton High School class is sponsoring its five-year reunion on Saturday, Dec. 27, at Plymouth Elks Club, 41700 Ann Arbor Rd. from 6 p.m. to 1 a.m. For more information, call 455-8742 or 453-1915.

HOLIDAY BOWLING TOURNAMENT

In conjunction with Super Bowl Lanes, Canton's Parks and Recreation Department is sponsoring a Holiday Double Bowling Tournament, open to any township parent and child under 18 years, on Dec. 27 in two squads, at 9:30 a.m. and at 1 p.m. Cost is \$5 per two-game pee wee team, and \$6.50 per three-game team for all other children. Register at either the SuperBowl, 45100 Ford Rd., 459-6070; or at the Recreation Department, 397-1000.

OPEN RECREATIONAL SWIM

Open recreational swim will be held at Central Middle School pool from 7:30 to 9 p.m. Monday and Wednesday evenings, and at Canton High School pool from 3 to 4 p.m. and family swim from 4 to 5 p.m. Cost is 50 cents for students, 75 cents for adults and a maximum of \$1.50 for Canton High's family swim.

COFFEE WITH THE PRINCIPAL

Grade realignment will be discussed when parents attend "Coffee with the Principal" on Wednesday, Dec. 17 at 10 a.m. in Room 113 at Central Middle School.

TOYS FOR HANDICAPPED

Mel's Barbershop is collecting old toys in good condition for handicapped children. Anyone interested in making Christmas a little brighter for someone can drop off toys at the shop, at the corner of Forest and Wing Streets in Plymouth, Tuesday through Saturday from 8 a.m. to 6 p.m.

GOOD COVERAGE DOESN'T HAVE TO BE EXPENSIVE

Fight the high cost of insurance! Our new Home Protector Program features low rates to save you money. Get all the coverage your home needs in one convenient package. Call or visit us today.

Plymouth Insurance Agency

249 S. Main Street
453-4030



Coiffeurs By Joseph

Professional Cutting & Styling
Men & Women



Get Acquainted
offer
For the Holiday...

Texture Foam
wave of the Future
\$30.00 Reg. \$37.00
Including Haircut & Style

880 Fralick
Plymouth
453-2343
Open Evenings

HOUSE OF FLOORS & WALLS COMPLETE DECORATING CENTER

FOR FLOORS

- Armstrong
- GAF
- Congoleum
- Mannington
- Amtico
- Azrock
- Kentile
- Ceramic
- Bruce Flooring

FOR WALLS

- Major Brands of Wallpaper (with matching fabric)
- Wallpaper in Stock
- Ceramic
- Hoyne Mirror
- Z-Brick
- Paris Wall
- Glidden Paint
- Rough-it Texture Paint

Window Treatment

Bali Blinds • Vertical Blinds
Webb Woven Woods

Mon 10-9
Tues, Wed, Thurs 10-6
Fri 10-9
Sat 10-6

673 S. Main St.
Plymouth
453-6557



Stratford Swivel Rocker
Beautiful Herculuan velvet with reverse seat cushion. Many colors to choose from.

\$199⁹⁵
Reg. \$319.00

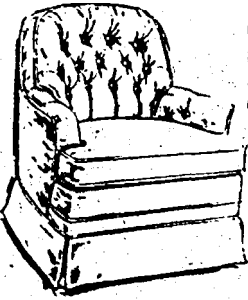

TENPENNY INTERIORS
42951 W. 7 Mile (Just E. of Northville Rd.)
in Highland Lakes Shopping Center. •
348-7174
Mon.-Sat. 10-8 Sun. 12-5

Dr. James Schelberg
Foot Specialist
Podiatrist - Foot Surgeon



39439 Joy Rd.
E. Of I-275 • Canton
455-0770
All Insurance Accepted
Mon.-Sat. and Evening Hours

tell it to
Phyllis



Only a week until Christmas and every child is wild with excitement and every mother is frantic with frustration. Why is the time from Thanksgiving to Christmas so long for kids yet so short for their parents?

It's the time of year when the best and the worst shines through all of us. Our qualities as well as our shortcomings seem to be on display more during the holidays.

For someone who hates to shop, burns toast in the toaster, and can't figure out how to work the vacuum cleaner, this is not the time of year to suddenly become domestic. However, Christmas wouldn't be Christmas without all the shopping, baking, cleaning, and general madness that goes with it.

It takes an hour to write out a shopping list, a half hour to find a parking place, and only two seconds to mail the shopping list instead of the Christmas cards. How can anyone be so stupid as to mail a carefully made out grocery list? Once it's in the mail box, it becomes the property of the U.S. Government and there's not a darn thing you can do about it. I wonder if someone at the post office will recognize my writing and return it. I guess I'm lucky I didn't try mailing the car keys with it.

Like many Santas, we are cutting down on the amount of money we spend on gifts. There is one toy on a very special person's list that I have been searching for. Why is it when you're looking for just one thing, the whole world just sold out? I have gone to or called every store I can think of that might carry it. Oh well, I'll have to come up with an alternative plan B, whatever that is.

Then there's Christmas cookies that have to be baked. Every year I swear never again, and every year I'm foolish enough to try just once more. This year I did something new -- I managed to set off the smoke alarm before I put the first batch of cookies in the oven. Believe me, that does a lot for your self-confidence.

More flour goes on me and the floor that ever makes it to the mixing bowl. My kids have finally accepted the fact that their mom only makes handicapped ginger-beard men. If I don't break the head off, I'm sure to get one of the arms or legs.

Now as we enter that final week before Christmas, I guess it's time to finish the shopping and card writing, and get out the wrapping paper and ribbon. Now all we need is lots of snow to make it really seem like Christmas.

Barb Wiskowski, leader of the Plymouth Paw Prints 4-H Dog Obedience Club, recently organized the annual banquet. The club donated equipment to the Humane Society for the animal shelter. Club members who received recognition for the 1980 dog shows were: Wendi and Kristi Trexler, Michelle VueCasovic, Karen Wiskowski, Tom Hayes, Cheryl Schulanski, Neil Dostic, Nancy Jones, Wendy Good, Pam Gillespie, Collen Chrysler and Carolyn Kinsler.

WE HAVE THE ORIGINAL MOUNTAIN KING



Mountain King
The luxurious well proportioned tree that can be completely assembled in less than five minutes. Millions of people who saw it on TV agree. Now available at Cornwell's.

ALL ON SALE NOW

Over 50 to Choose From from 1 ft. to 15 ft. Available

What makes our artificial trees more unique?

- *Flame Retardant
- *No more needles in your carpet
- *Best looking tree in the forest without going out in the cold & snow
- *Long lasting
- *Economically advised
- *Quick & Easy to assemble

We still have a good selection of garlands, lights, outdoor lighting, stocking stuffers, German glass, paper, wreaths, etc.

CORNWELL Christmas World

PLYMOUTH
874 Ann Arbor Rd. (Just West of Main)
459-7410
Hours: Mon., Tues., Thurs. 10-7, Fri. 10-9,
Sat. 10-6, Sun. 12-4, Closed Wed.



Lay-Away Available



CARAVELLE
by BULOVA

A lot of watch for a little cost



from \$29⁹⁵

Introducing the inflation fighters... Caravelle watches by Bulova. They're your best buy today. Only Caravelle gives you high quality at an easily affordable price. And combines smart styling with a dependable precision-jeweled movement in such a wide range of styles and prices. Come see, come save... with Caravelle by Bulova.

A. Electronic with set-o-matic feature. Silver-tone case, tritium indicators, water resistant \$49.95
B. Rugged silver-tone watch. Water and shock resistant. Stainless steel bracelet \$39.95
C. Precision jeweled classic in silver-tone. Luminous dots, hands. Water resistant \$29.95
D. Neatly tailored in gold-tone with raised gilt markers. Black nylon bracelet. 17 jewels \$44.95
E. Sculptured gold-tone case, textured bracelet. Champagne dial. 17 jewels \$54.95

Bluford JEWELERS
"The Store that Service Built"

Master Charge, Visa, Layaway, Bluford charge

Hours: Mon.-Fri. 9-9
Sat. 9-6
Sun. 12-5

"Dear Santa..."



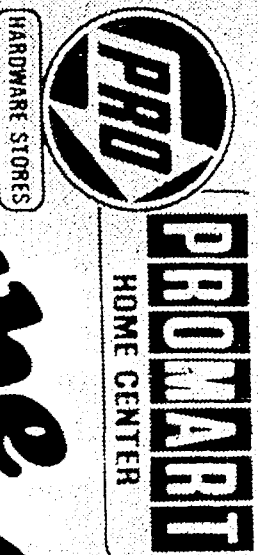

HARDWARE STORES

the Gift Right Price

GET
PRO-ADVICE
PLUS A REAL GOOD PRICE.



Black & Decker
BENCH TOP
WORKMATE
2999

Clamps mount to surface up to 2 1/2" thick. 16" vise jaws tilt up to 45° for working ease. While jaws grip objects up to 12" wide, individually adjustable hinges to be held, and V-grooves in

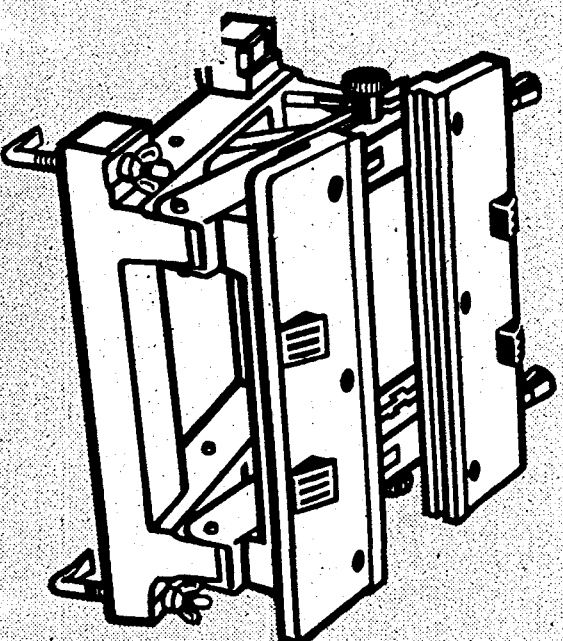

(SALE ENDS 12-24-80)

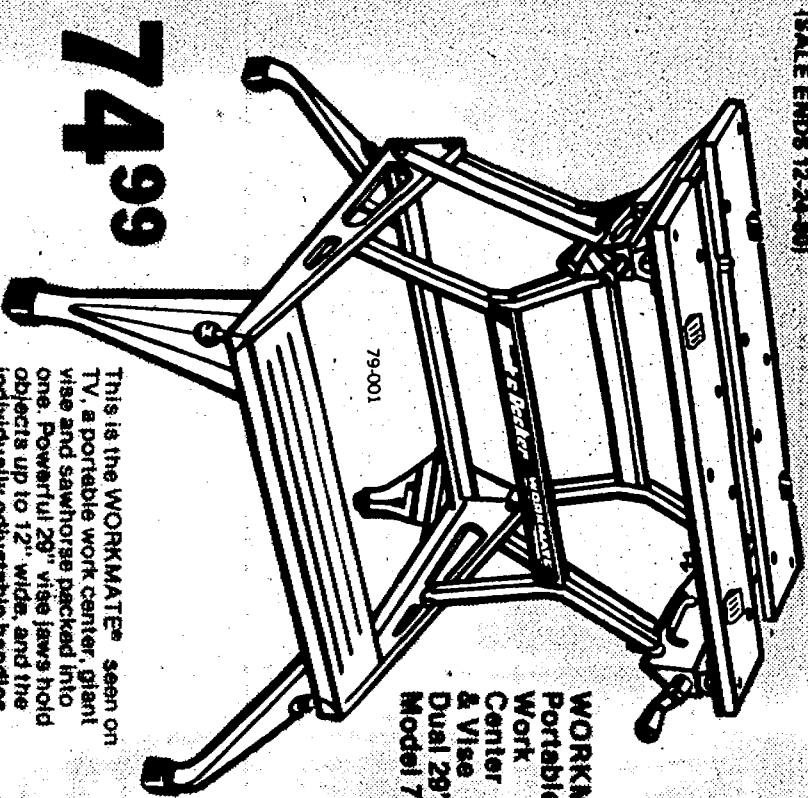

WORKMATE®
Portable
Work
Center
& Vise
Dual 28"
Model 79-001

7499

B-D
Black & Decker.

Black & Decker.

7470
**WORKWHEEL™ Power Stripper
and Sander**

\$4979

VALOR-PLUS™
Added features for versatility.
Exclusive multi-purpose tool capable of performing a wide variety of material removal and finishing operations. Sands flat and contoured surfaces, removes rust and paint, polishes, buffs, sharpens, with proper accessories. Two speeds let you pick the speed to suit the job. Car be held in WORKMATE™ jaws or bolted to work bench with included mounting bracket. Includes flap wheel with 60 grit unattached sandpaper. 100 grit standard sandpaper trim, mounting bracket.

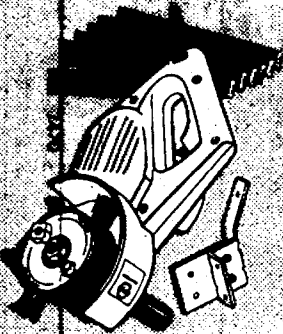

B-D
Black & Decker.
2 H.P. CARBIDE TIPPED BLADE
7 1/4" CIRCULAR SAW

6999

This \$500 rpm, 10 amps circular saw is designed for builders and has permanently lubricated ball and roller bearings. Sawdust ejection chute keeps sawdust away from cutting line. Double insulated and UL approved. (34)

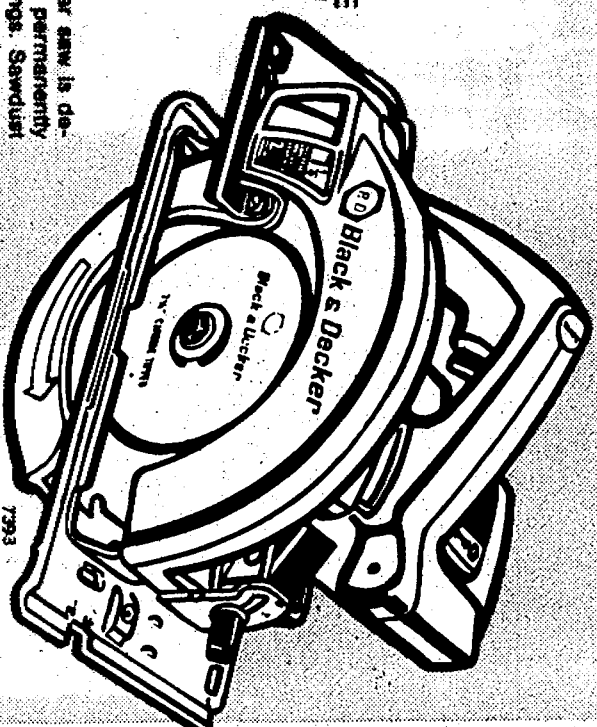

Black & Decker.

1/2 SHEET
FINISHING SANDER

VALOR-PLUS™
Added features for versatility.

1/3 HP (max. motor output) Large 4-1/2" x 11" sanding surface. Gets jobs done faster, easier. Orbital action for fast material removal. Double insulated. Detachable 6' cord with integral strain roller. Accepts optional 74-000 Dust Collecting Sanding Attachment.

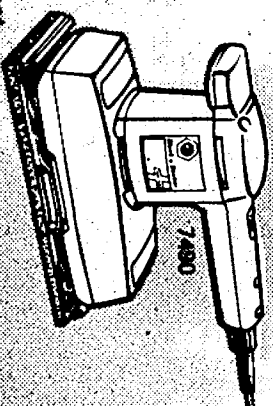

3499
IN LIMITED
QUANTITIES



It's a drill or it's a screwdriver. Reversing variable speed variable torque or jamming drill. Trigger can be locked at correct speeds for every job. 3/4 HP. Double Insulated. (81)

Black & Decker
3/4" VARIABLE SPEED
REVERSING DRILL
2599



S & W PRO HARDWARE

875 ANN ARBOR RD., PLYMOUTH • 453-1290





STANLEY
FAMOUS POCKET
SUFOAM PLANE
269

Incredibly handy for speedy cutting and trimming. Non clogging steel blade. (126)

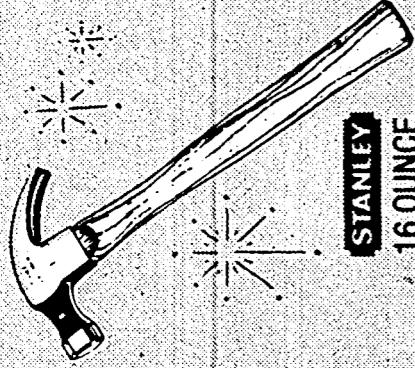

STANLEY
16 OUNCE
NAIL HAMMER
599

Firm tempered face minimizes chipping. Hickory handle. (119)

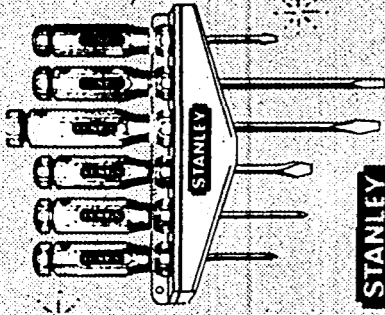

STANLEY
HANDYMAN
SCREWDRIVER SET
WITH
WALL
RACK
599

Contains a 4 & 6" standard blade, a 3 & 6" small cabinet blade, and a No. 1 & 2 Phillips. Wall rack included. (130)

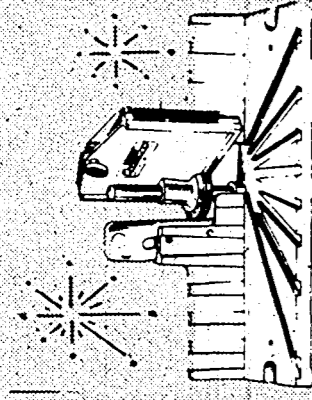

STANLEY
Now!
PROFESSIONAL TYPE
MITRE BOX
1399

Metal mitre box adjusts easily to 90°, 60°, 45°, 30° angles. Uses panel and back saws. (110)

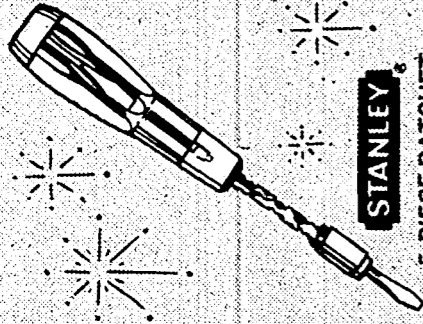

STANLEY
5-PIECE RATCHET
SCREWDRIVER
799

Drives and draws screws, bores small holes. Comes with 2 drill bits and 2 screwdriver bits, stored in the handle. (129)

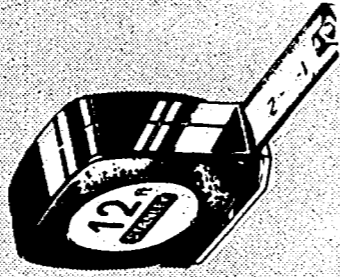

STANLEY
12 FT. LOCKING
TAPE RULE
549

Efficient 3/4" tape rule with long wearing yellow face. Locks in place. With belt clip. (64)

DURACELL®

Batteries Make Holiday Fun Last Longer



"D" Size
2 for
139



C Size
2 for
139



"AAA" Size
2 for
129

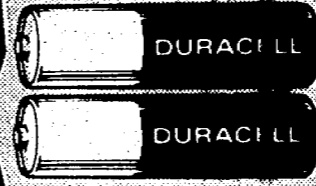

"AA" Size
2 for
139

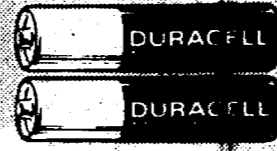

"AA" Pack
of Four
199

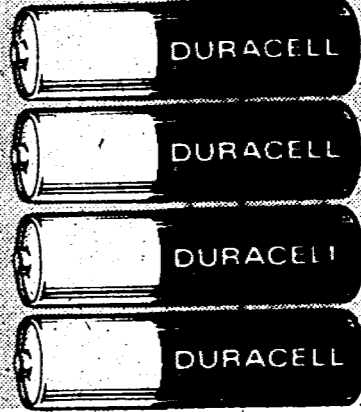

9 Volt
139
each

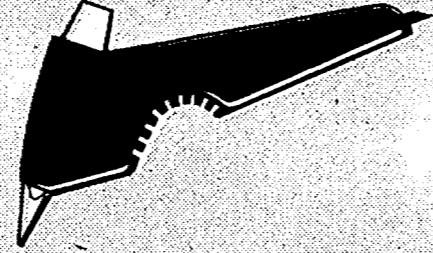

Thermogrip®
ELECTRIC
GLUE GUN
599

Melts solid glue sticks to bond wood, leather, etc. instantly without clamping. (74)

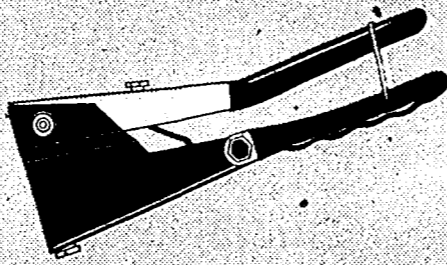

Bostik
WORKSHOP
POP RIVET TOOL
599

Rivets are applied from only one side making repairs that were previously impossible. (73)

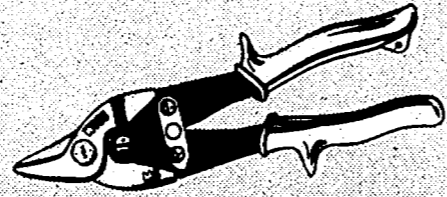

WISS
MULTI-PURPOSE
SHEARS
799

Cut intricate patterns from stainless steel and other materials up to 18 gauge. Your choice of right or left cutting or straight Plastic grips. (60-61-62)

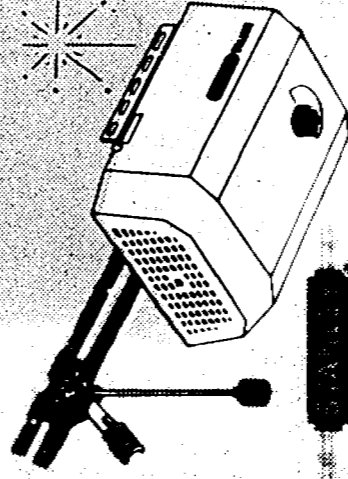

AN IDEAL GIFT PRICED RIGHT
DELUXE GARAGE DOOR OPENER
A DELUXE
CHRISTMAS GIFT
14999

Powerful 1/4 H.P. motor, chain drive opens 18" wide and 7' high doors. Digital controls—you can set your own code from over 1000 combinations. Descending door reverses when it touches an object on the down. 3 minute fight time delay. It's easy to install yourself. A deluxe Christmas gift. (143)

• EXTRA DIGITAL CONTROLS (143A) 24.00

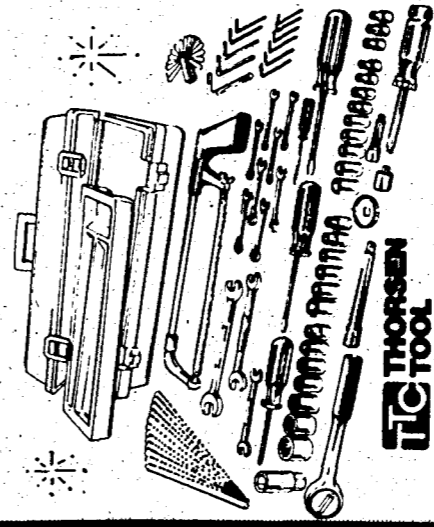

I.T.C. THORSEN
TOOL SET
74 PIECE
TOOL SET
4999

OUTSTANDING PRICE

The set is just what a home mechanic needs to make household and automotive repairs. The assortment includes a hack saw, ratchet with a big assortment of sockets, screwdrivers, an assortment of important wrenches, tool box with tray and much more. (124)

SALE ENDS 12-24-80

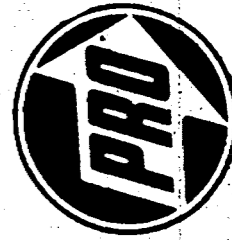

S&W PRO HARDWARE

875 ANN ARBOR RD., PLYMOUTH • 453-1290





puritan[®]

**Puritan Full Fashioned
Soft Touch Knits**

Puritan full fashioned knits never bind, never pull.
And they retain their shape and buttery-soft
richness through easy machine wash and dry care.



Tis the Season...

FAMOUS
MENS WEAR

924 W. Ann Arbor Trail
Plymouth, Mi. 48170
453-6030

Mon. thru Sat. 9:30-9:00
Sun. 12 to 5 pm
Free Validated Parking
Free Gift Boxing
All major credit cards accepted

20% off
regular price
on our Entire
Stock of ladies...

- Coats
- Dresses
- Lingerie
- Handbags
- Sportswear

Kay's
of Plymouth

Hours:
Mon.-Fri. 9:30-9
Sat. 9:30-6 pm
Sun. 12-5 pm
453-7855

846 W. Ann Arbor Trail
Use your VISA, Master Charge or open a Kay's Charge

**HAVING A PARTY?
LAWSON'S FOOD & DELI
MAKES**



**DELICIOUS
PARTY
TRAYS**

Many sizes to choose from
All beautifully garnished
★ CHECK OUR PRICES FIRST ★

We Have **ONE DAY SERVICE**
BEER·WINE·PARTY FIXINS'

**TWO CONVENIENT
LOCATIONS:**

885 Penniman
at Harvey
PLYMOUTH
453-3190

and

43340 Warren
between Lilley & Sheldon
CANTON
455-4790

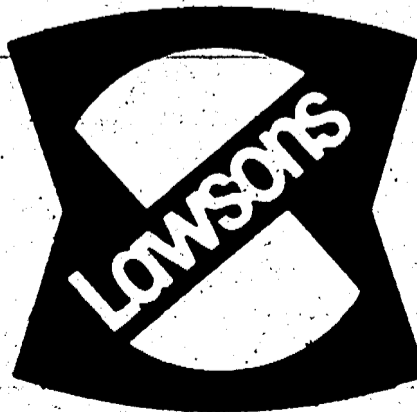

Fourth grader wins grand prize in contest

Mike Guttentag, a fourth grader at Eriksson Elementary School is the grand prize winner in the second annual Community Crier Christmas Coloring Contest.

Mike's artistic efforts earned him a \$40 gift certificate from a local merchant.

Some 388 youngsters entered the coloring contest, sponsored by The Crier. Entrants colored a drawing of Santa Claus printed in past issues of The Crier. They also included letters to Santa, which are printed on the following pages of this special "Plus" supplement of this newspaper.

Contestants were divided into three age categories: pre-school-grade 1; grades 2-4; and grades 5-8. The winners in each category won a \$20 certificate from a local merchant.

Scott Latham, a six-year-old first grader at Starkweather School, was named the pre-school grade 1 winner. His parents are Jerry and Kathy Latham of Plymouth.

"I would like a BMX Mongoose bike, a sound race track, football pennants, and a black suit and tie just like my Dad's," Scott wrote Santa.

The winner in the grades 2-4 category is Jenny Mackiewicz, a Bird School second-grader. Her parents are Paul and Pat Mackiewicz of Plymouth Township.

"I have been a very good girl all year," Jenny told the Great One from the North Pole. "Please bring me a pair of ice skates and a baby feels so real."

The grades 5-8 category was won by Lisa Pata, an eighth-grader at West Middle School. She is the daughter of John and Carol Pata of Plymouth Township. "I would like a sewing machine for Christmas most of all," she told Santa.

The contest judges also chose Wendy Hix, of Plymouth Township, winner of an honorable mention in the grades 5-8 category. "I would like many things for Christmas such as: a clock radio and toys, but the thing I want most is peace and



MIKE GUTTENTAG

harmony for boys and girls," she wrote Santa.

The contest judges were: W. Edward Wendover, publisher of The Crier; Phyllis Redfern, officer manager of The Crier; Pat Carne, a Plymouth artist; and Marilyn Barrick, an art teacher in the Plymouth-Canton school system.



SCOTT LATHAM, a six-year-old Starkweather Elementary School first grader, won first prize in the Pre-School-Grade 1 category of The Crier's annual Christmas Coloring Contest. He's the son of Jerry and Kathy Latham of Plymouth.



LISA PATA, 13-year-old daughter of John and Carol Pata of Plymouth Township, won first place in Grades 5-8 category of The Crier's annual coloring contest. She is an eighth grader at West Middle School.

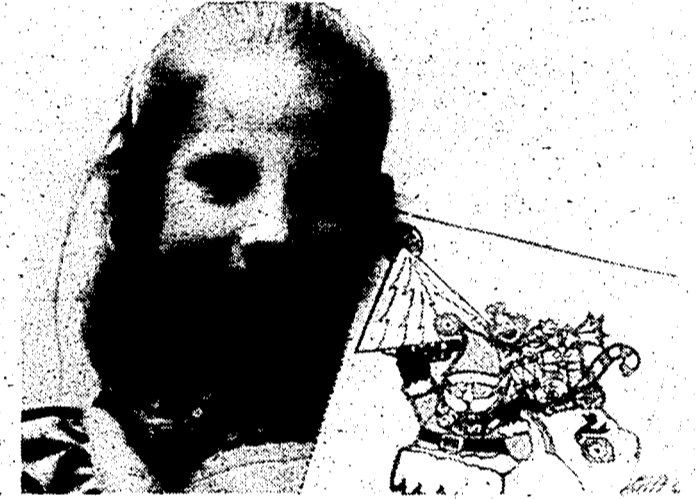

JENNY MACKIEWICZ won the first place in the Grades 2-4 category of The Crier's annual coloring contest. She is a seven-year-old second grader at Bird Elementary School and is the daughter of Paul and Pat Mackiewicz of Plymouth Township.

Dear Santa... Kids tell their Christmas wishes

I would like snowspeeder, Darth Vader Collector case, Imperial Attack Base Navarone, Electronic Battleship, and Shoot-out in Space. Thank you.

ADAM SLADE
Canton

I have been good. I would like a stuffed Reindeer Animal, all The Strawberry Shortcake dolls, And A Real Dog. My sister and me will take care of him.

CHRISTINE GONSIORWSKI
Canton

For Christmas I don't want to give you trouble, so all I want is: a ten-speed bike, a new pair of roller skates and a book. I am 10.

AMY MUDLOFF
Canton

I've been wanting Strawberry shortcake since last year. I wish you could bring her on Christmas. When I wake up on Christmas I wish to find her under the tree.

CARRIE MAZURKIEWICZ
Canton

I would like a tape recorder. I have been a good girl.

LAURIE SANTO
Plymouth

I would like a Fresh n' Fance and roller skates and chinese jumprop and candy and stickers and records, Zanadu back pack, Merlin and film.

ROXANE BREault
Plymouth

I would like a fat wheels, an electric guitar and a super stunt dirt bike. I would also like my doggy to feel better and bring her dog biscuits.

DAVID ASKEW
Canton

This picture is from Amy Mayo. I would like a doll and a new game for Christmas. I have been good. Merry Christmas. Love,

AMY MAYO
Plymouth

I have been good this year and I want a doll and a Barbie doll and a doll house and a play car and a ball. Thank you. Love.

JENNIFER WARNICK
Canton

I would like a Bean Bag and Space Legos.

JUSTIN SEMION
Canton

Happy Holidays. I want Darth Vadars Collector-Case, and anything else you want to give me.

STEVEN HOFFMAN
Plymouth

I love you. I would like some slippers, three belts and a real horn. Love.

JENNIFER KWASNY
Plymouth

Please help the hostages get back. Also help people that are sick and starving. And everybody have a Merry Christmas.

WENDY MORGAN
Plymouth

I wish you would bring me a play house that I can walk into. Santa be careful on your Sleigh course, you have a lot of toys to carry. Love.

KELLY MAZZIE
Canton

Ho! Ho! Ho! I would like "Zip Zap Race Track" for Christmas and I need to be good. Please come down our fireplace here in Canton and not my old one in Chicago. We just moved here. Love.

BRAD GRULKE
Canton

I want a spelling B. And I want a vest and jacket.

SAMANTHA A. MCBEE

What I would like is for all the girls and boys, to have the mother, father, grand father, and grand mother that I have!

CATHY CRICHTON
South Lyon

PS See you on Christmas.

I would like a BMX Mongoose bike, a sound race track, football pennants, a black suit and tie just like my Dad's. Thank you Santa.

SCOTT LATHAM
Plymouth

I would like to have the biggest Christmas party for all my friends.

RON BIELSKI
Plymouth

I wood like a x-wing fighter and I wood like some cars. The little cars you no what I mean.

KEITH KWASNY
Plymouth

I want tap shoes and a doll and some roller skates and some soap and I would like something from Aron.

SUSAN JOWSEY
Plymouth

Great GIFT IDEAS From SAXTON'S

- Wild Bird Feeders & Feed
- Pet Toys and Goodies
- Planters and Pots
- Lawn Spreaders
- Rain Gauges
- Bulbs -- Amaryllis & Paper Hyacinth
- Nylon Trimmer-Edger
- Weber Grills & Accessories
- Black & Decker Tools
- Chain Saws
- Snow Blowers
- Garden Tools and Supplies and much, much more!

We Are Santa's Helpers

SAXTONS GARDEN center inc.

PLYMOUTH • 453-6250

**Hours: Daily 9-6
Fri. 9-8 Sat. 9-5**

Plus

Dear Santa

I would like some books by Judy Blume a record called Hit line, some furniture for my doll house, but what I really want is everybody to have a very nice Christmas.

MICHELLE BRYJA
Canton

This Christmas I am older and I don't get toys so the main thing I want is a set of heat rollers and for everyone to have a nice Christmas.

LORI BLADZIK
Plymouth

I would like a Candy Doll and a Mopet Doll House. I would also like a winter hat & mittens to keep my hands warm. I also would like some money so I can buy my big brother a present. Thank you.

THERESA ANEED
Canton

For Christmas I would like a real dog and a sleeping bag and a doll house and a nice pair of downhill skis. Have a merry Christmas.

TAYA TIPLADY
Plymouth

I hope everyone has a nice Christmas, you too. Love,

AMY WIRTH
Canton

This year I want some new pajamas, a tape recorder, and a polaroid camera. Love,

KATHLEEN BOYLE
Plymouth

I'd like from you all these things. A doll house? The barbie dream house? The barbie stage? Nice clothes for Brooke? and money for mom & dad.

BREE STOKANOVICH
Canton

For Christmas I want two things. the hostages freed and World Peace.

MIKE WERNIMONT
Plymouth

I want a 5 speed bike and anything else for Christmas.

KAREN WERNIMONT
Plymouth

I would like a maragrouwnd stroler, hichar, Baby Criys for you and a teddy bar.

DANIELLE GUTHRE
Westland

I wish all the people in the world a Merry Christmas and that every child gets at least one (1) thing to make him happy. Truly yours,

CANDI JONES
Canton

What I would like for Christmas is Super Perfection, Simon, a barbie, and a teddy bear. Love,

MICHELLE WANAT
Canton

What I want for Christmas is a baby doll, barbie, strawberry shortcake, Mandy, sewing machine, stickers, candi head, juicer blender, cake maker.

AMANDA BELL
Plymouth.

Please bring truck, Legos, Road Truck, Matchbox cars, Tonka Truck, Fisher Price Play Farm.

JASON KUCZYNSKI
Canton

I would like a play piano.

BRIAN TIBURZI
Canton

I want Star Wars toys. But I will keep what you bring me. I love you.

BRYON LABUMBARD
Canton

I would like to get these things; 1. health 2. good care 3. peace 4. knitting basket 5. pom-poms 6. latchhook kits 7. badis 8. watch 9. hairbrush 10. robe, slippers 11. ice skates 12. earrings 13. earring holder 14. comb set.

KIM WALLACE
Canton

Shazam cruiser, Bugs Bunny book, superman cut out book.

JUSTIN SEMION
Canton

This year I would like soundgizma/Krusher/ Mr. Mouth/Split Second. Love,

CHRIS BOYLE
Plymouth

I want a Detroit locket and I want some suspenders and have a nice holiday.

TINA QUATTRO
Plymouth

I want a Detroit Lions jacket and I want a radio-controlled jeep and I want a safe and happy holiday.

MIKE QUATTRO
Plymouth

I hope that you have a nice Christmas and I love you and Mrs. Claus and I hope that I get a lot of toys and I'm very good.

DEREK OLSON
Plymouth

Claudette's FASHION

Plymouth Square Shopping Center
(Corner of Ann Arbor Rd. & Sheldon Rd.)
44515 Ann Arbor Rd. Plymouth
458-1010
Regular Store Hours: Mon. thru Sat. 10 am-9 pm
Sunday 12 noon-5 pm
GOB Permit No. 1

Further Drastic Reductions on ALL Merchandise!!! Nothing Held Back

These Prices are AT COST or BELOW. We have to Sell Out to Bare Walls. Our Days are Getting Shorter. The End is Near

Christmas is Near · Take Advantage of these Super
! Saving Prices Now!

SWEATERS

All Styles

\$5, \$7 & \$9

**Misses &
Junior
PANTS**

\$7 to \$10

Assorted

KNIT TOPS

\$2 to \$6

VELOURS

\$8

Corduroy & Denim

JEANS

\$9⁹⁹

Flannel & Plaid

**WOVEN
SHIRTS**

\$5 & \$6



EXCHANGE PRIVILEGES

Shop Your Hometown Merchants . . .

The First National Bank of Plymouth is pleased to help sponsor the Christmas Shop Plymouth program. We feel it is important for all of us as merchants, and all of us as Plymouth residents to support our local businesses. They provide goods and services to us for our year 'round needs . . . So we feel it is important to shop in Plymouth during the holidays as well . . .

Les Campbell

Campbell's of Plymouth

"With the support of the Community, merchants will increase their services and merchandise and thus bring traffic from outside the immediate area which makes Plymouth Stronger."



PG. 19
THE COMMUNITY CRIER: December 17, 1980



CHRISTMAS SHOP Plymouth



**FIRST NATIONAL BANK
OF PLYMOUTH**

Ann Arbor Rd. Office:
39475 Ann Arbor Rd., east of I-275

Phone: 459-9000
Member F.D.I.C.

Main Office:
535 S. Main Street

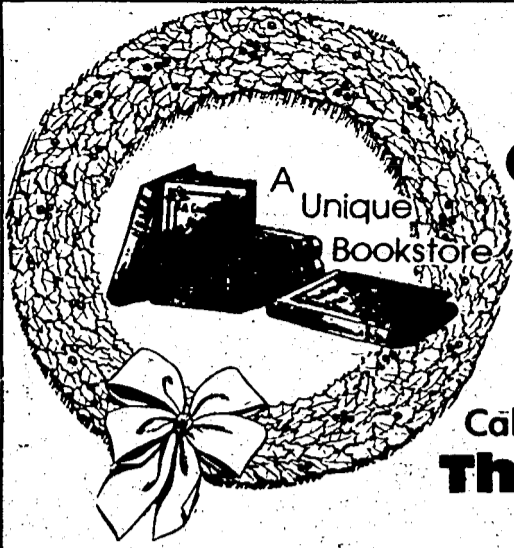

MAKE IT A MERRY CHRISTMAS!

Give a Special Book to a Special Person

Calendars, Cards, Posters Too!
The Printed Word
146 Mary Alexander Ct.
Northville, Mich., 48167
348-8050

Happy Holidays from

BROWNBERRY "Natural Bread" THRIFT STORE

31221 FIVE MILE near Merriman, Livonia

FREE DRAWING for our 5 ft. TOY FILLED Stocking

Breads Baked with Natural Ingredients, Pure Vegetable Shortening, and No Artificial Preservatives

Drawing Dec. 24

Come in and fill Out your Coupon

- No Purchase Necessary •
- Croutons • Stuffing Mix
- Bread Sticks • Penn Dutch Cookies

Open Daily 9-7
Saturday 9-6
Sunday 10-5

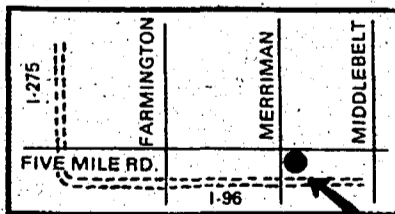

BROWNBERRY THRIFTSTORE

Coupon

FREE LOAF OF BREAD
your choice

with this coupon
Good Dec. 17 thru 24

Plus

Dear Santa

I have been a very good girl all year. Please bring me a pair of ice skates and a baby feels so real. Love,

JENNY MACKIEWICZ
Plymouth

I was a good girl this year. I would like My Pal Snoopy, the stuff animal snoodly and lots of other things. Thank you. Cookies on the table.

KERIE O'DONNELL
Plymouth

I would like a 10 speed bike, Roller skates, Jersey T-Shirt and a Barbie Beauty Dog. I have been a Good Girl. Love,

LORRIE WALLACE
Westland

All I want for Christmas is one big happy family.

HEATHER HELTON
Canton

Please get me, a Miss Piggy doll, fresh n fancy, Beauty Barbiedoll dog, a 3 speed bike, play-doh, Microscope, a 23 key typewriter.

KELLY WIDDICK
CANTON

I want rubiks cube and I want number up and Hangman and macrome Owl and pottery craft and Hair stiling set and starr dolly and operation and Skedodie and Sweetie face.

ANNE ZAWADZKI
Canton

May I please have a stuffed animal. Thank you.

ANN BIBERDORF
Plymouth

May I please have a baby feels so real doll, and a New teddy bear. Love,

LYNN BIBERDORF
Plymouth

I have been good this year. I would like... a ten speed bike and a curling iron and clothes and a game called "go to the head of the class." I would like some things in my stocking. Bye Santa.

HEATHER HAZLETT
Plymouth

Charlie McCarthy Ventriloquist doll. Roll-top deak and chair set. Spelling B speaks spell, 25 3/4 inch peg tuned folk Guitar unit with built-in AC, snoopy pencil kit and Battleship Payday.

KELLY PODRASKY
Canton

I would like a bike. It will have dirt wheels and it will be pink. If you or your elves can make. Thank you. Your friend,

JENNIFER HUCKABA
Canton

I hope I get Atari. I hope we have a safe drive to Missouri. Have a Happy Christmas Santa.

JILL BENTON
Plymouth

Please bring me a Knit Magic set, Pottery-craft, Holly Hobbie watch, Barbie Doll's Dog, Big Bounce, Trek-U-Lator, 26" round table and chairs. Thank you.

MICHELLE WILDER
Canton

Please bring me some clothes, also speak & spell, a watch, U-Drive It, Operation and any thing you think I might like. Thank you.

TOMMY WILDER
Canton

I want Stickers and Hello Kitty Stickers and Hello Kitty Stuff and Blue-Berry-Muffin and Books and cloths.

SHANNON HARPER
Plymouth

I would like for Christmas a pair of roller skates, lip gloss, canmdy and a nice hug. Thries cookies and coffe here waiting for you. Love,

HEIDI NEUROTH
Canton

Dear Santa please bring me a doll and a bugee. I will be good. I love you. I help my mother all the time and practice my clarinet.

LYNN ANDERSON
Plymouth

Could you wake me up on Christmas Eve and show me Rudolph. I won't tell anybody. I want Beauty Secert Barbie doll and Police Chase and race. I love you always. Love,

BECKY HRBCEK
Canton

I would like a doll and a lot of stuff in my stocking. I would also like some jewelry. I hope you have a Merry Christmas. Love,

JULIE LOCKWOOD
Plymouth

For Christmas this year I'd like a special baby doll for on my bed. It would be fun to have Fresh & Fancy or Wings of sound album for our family. Love,

SHANNON SOENEN
Plymouth

I hope you like my picture. I am 11 years old and I have been good. I hope I see you soon. I want a walkie talkie, drum set, guitar and an organ.

YVONNE LIVERNOIS
Canton

I would like a BMX for Christmas and a new electronic game. I would like my BMX from Trading Post of Schwinn Bike shop. Thank you.

KARON BRUTON
Plymouth

For Christmas I would like a quilt with a cat on it, a pair of Calvin Klines, a new pair of figure skates and a sweater to go under my vest.

JESSIE TREPANIER
Canton

Please bring me a stereo and roller skates too, and I'll be one of the happiest person's you ever know.

ANGELA DUGAS
Canton

I would love to have a pair of cross-country skis for Christmas. I would also like a telescope or a microscope or binoculars. I would also like lip balm.

MALIE SHIRMOHAMMAD
Plymouth

I've been very good this year! I wish everyone in the world could feel the Christmas spirit. And the excitement of the first snowfall. Plus the gift of happiness. But most of all "The gift of Love."

KRISTEN SALBERA
Canton

I want Barbie's Dream House. I want Barbie's Motor Home. I want Barbie's Camper. Thank-you for my Big Doll last year. I love you Santa. Your friend.

AMY STIDWILL
Plymouth

I want Head to Head football, Space Invaders, 5 wishes, Remote control car, R.C.A. race trak.

TODD BOUCHER
Canton

This is what I would like for Christmas. I would like a Back Gammon set, some books and some clothes. I would like some other stuff too.

AMY NELSON
Plymouth

We Wish
You the
Merriest

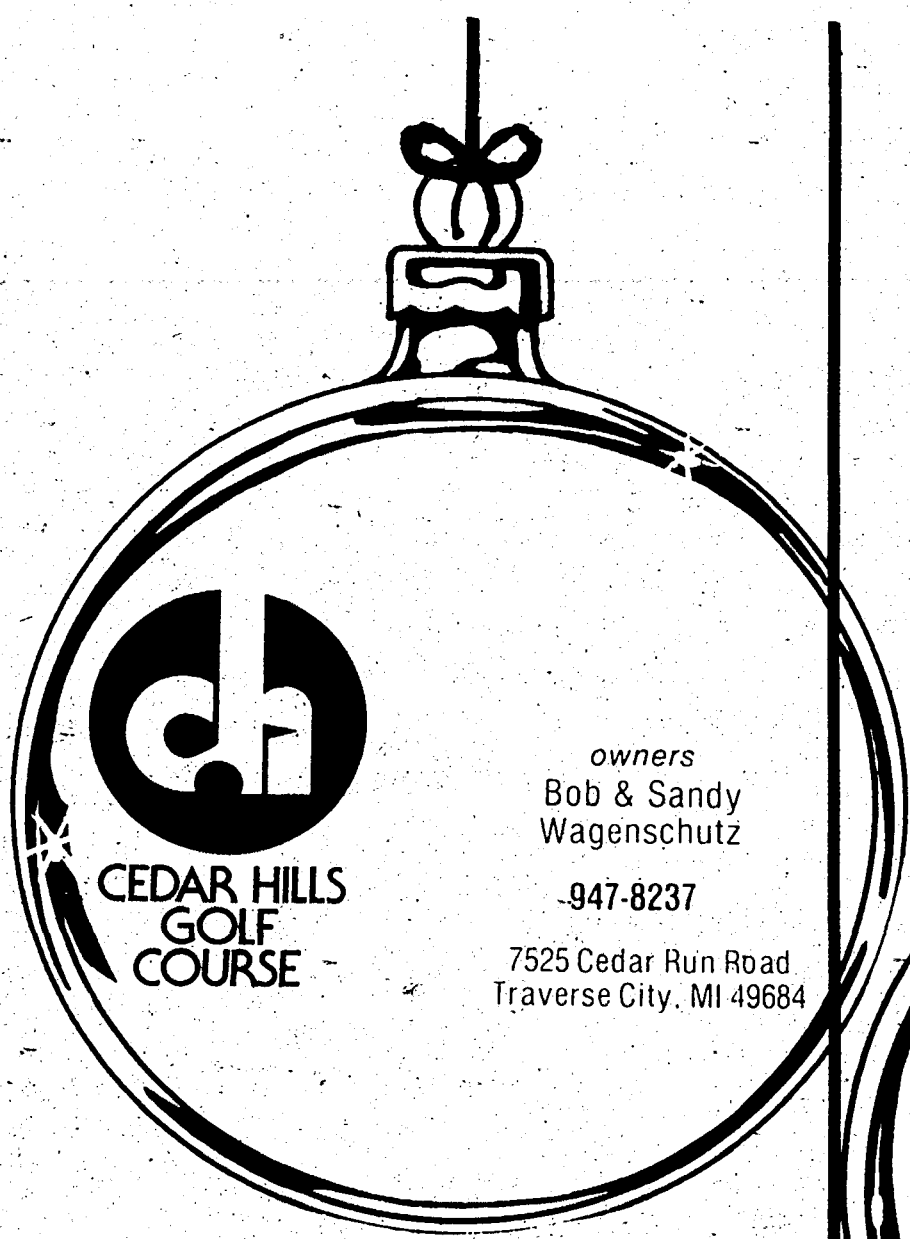

CH
CEDAR HILLS
GOLF
COURSE

owners
Bob & Sandy
Wagenschutz

947-8237

7525 Cedar Run Road
Traverse City, MI 49684

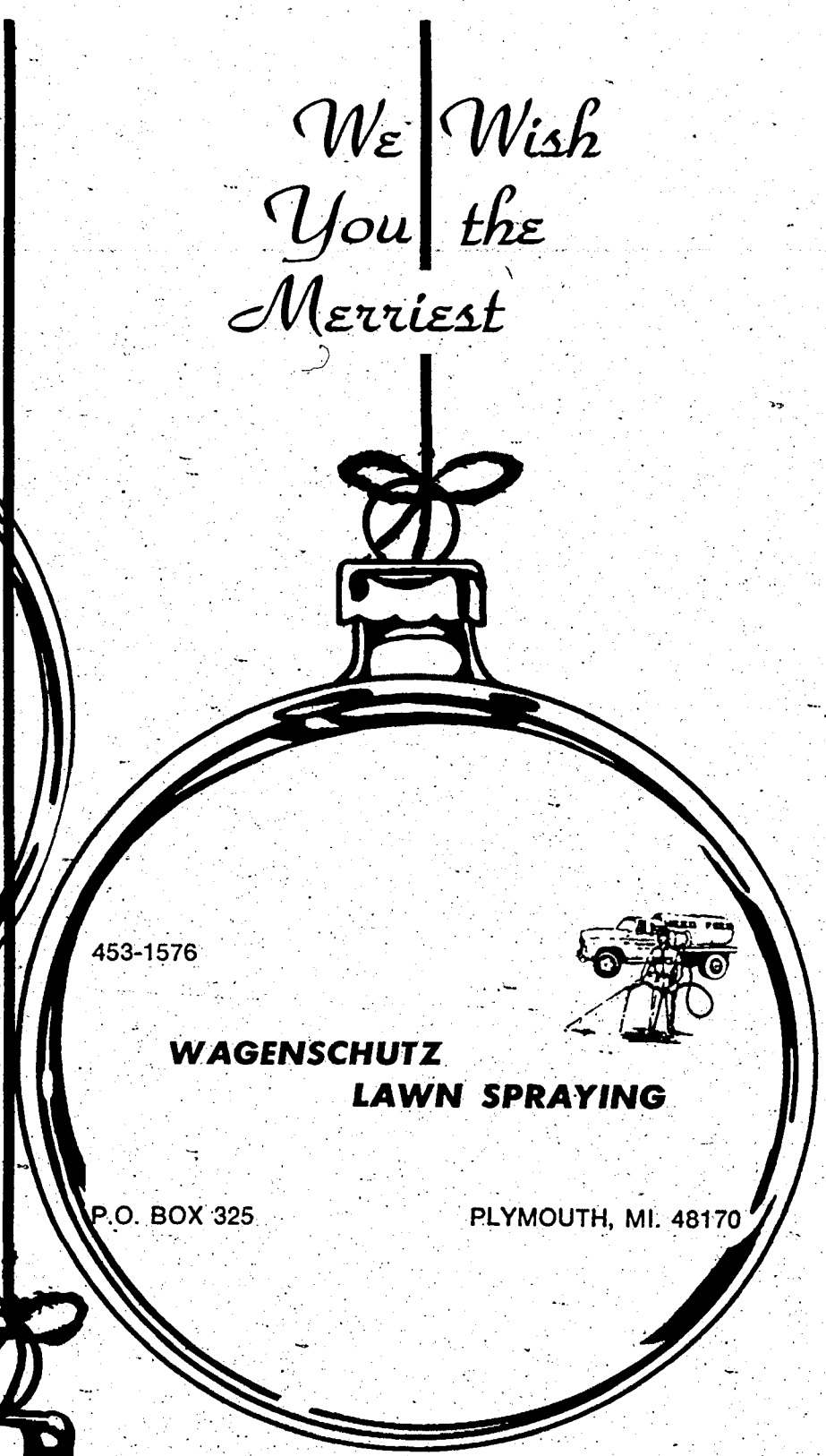

453-1576

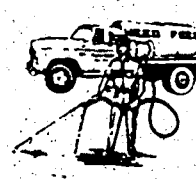

**WAGENSCHUTZ
LAWN SPRAYING**



P.O. BOX 325 PLYMOUTH, MI. 48170

There are times when it's nice to wish
happiness to Special people. May you
find a renewed sense of love and
brotherhood in the life we share

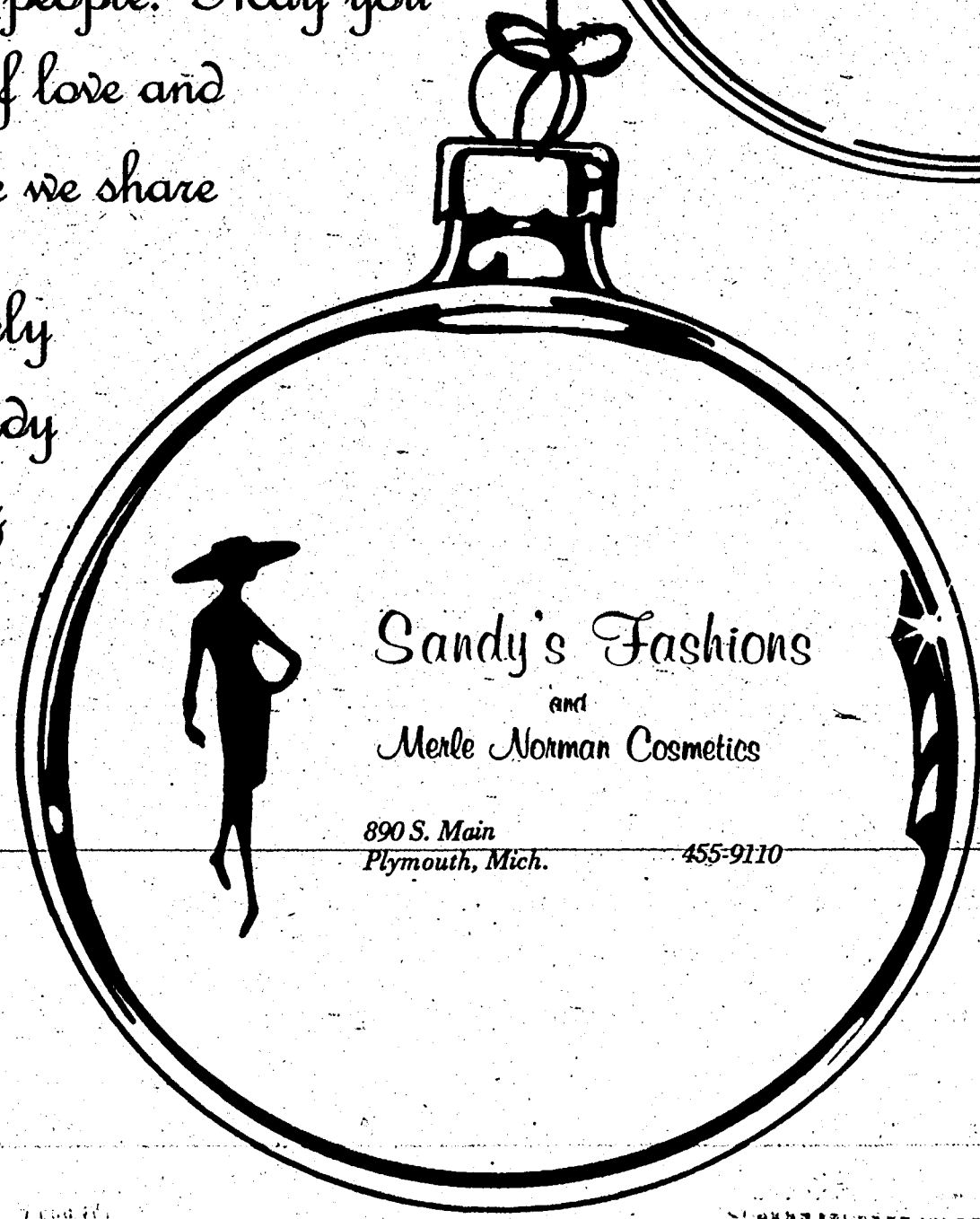
Sincerely
Bob and Sandy
Wagenschutz

Sandy's Fashions
and
Merle Norman Cosmetics

890 S. Main
Plymouth, Mich. 455-9110

Dear Santa

I have been a good boy, I help my mom and dad I want a boat and a kite.

MIKE GRAPER
Plymouth

Will you get me a drum, doll and a kite? I have been a good girl. Thanks,

AMY SMITH
Plymouth

I have been a good boy. I help my mom and dad. Please bring me a train and a car. Thanks,

MARTIN MCKINNEY
Plymouth

I am a good boy. I help my mom and dad. I want a drum and a train.

MATT BELHART
Plymouth

I have been a good boy. Please bring me a drum and a boat.

DARIN BELL
Plymouth

My name is Sharon. I am 5 years old. I hope you will bring me a sewing basket with things in it, and a small puddin baby doll. Love,

SHARON TOWAS
Canton

I want a high chair for Christmas and a chair and a pink dollie set. Can you send me you picture, Santa Claus, and a play telephone? Love,

GIAN CIMO
Canton

I would like a radio control car, hot wheel set, cars & trucks, Mr. Mouth and 2-XL.

KENNY SEARS
Canton

My Baby brother Kevin needs some new toys so he doesn't have to play with mine and Matthew's.

KEVIN GLOBKE
Canton

I would like all the new star war toys. Matchbox garage, stomper 4x4's and maybe some cars & trucks. I'm trying my best to be good.

MATTHEW GLOBKE
Canton

My name is Laura I have been a good girl and I would like a Sweetie Face doll. I love you and wish you a merry Christmas. Love you,

LAURA CARBONE
Plymouth

I want a drum and a toy soldier and I want a yogi bear puzzel and a toy Santa Claus. Love,

PAUL BUROW

I want a Holy habe oven.

ANDREA
Plymouth

I want Empire Strikes back things. Love,

MARK CAMPAGNA
Canton

I love toys, racetrack, any clothes, any Golden Eagle, any learning machine.

BENJAMIN VERESH
Plymouth

Please bring me Princess play cosmetics and paper dolls.

KRISTIN GOFF
Plymouth

Please bring me a Baby Soft Sounds. Love,
REBECCA MCBEE
Plymouth

I am 3½ years old. I would like somemore Empire Star Wars people like Princess Leia, Yoda and a Snow Soldier. I've been trying to be a good boy. Love,

JASON D. BROOKS
Canton

Mommy had to print this since I can't write yet.

Big Track, train, rocket, record and teddy bear.

SEAN PINKERTON
Plymouth

My name is Laura, I want a pink sweeper, ball that glows in the dark, soft brown teddy bear, coffee set, doll with a hat, thank you, Merry Christmas.

LAURA SPAIN
Canton

I'm hoping for a stunt dirt bike, remote control car and a watchband, Love,

CHEYENNE RAMEY
Canton

I would like some candy canes and a dolly buggy. I would like some pretend food to go in my kitchen set. I am 4 years old.

ROSANNE DRESLINSKI
Canton

I want a baseball kid and Strawberry shortcake and Kissing Barbie. I hope you get all the toys made by Christmas.

WENDY CONWAY
Canton

I want 2 XL and I want Rubikscube and I want some clothes. Love,

ERIC KOITZ
Canton

I would like football equipment, dump-truck, cement mixer and a highway patrol set. Hot wheels and Sears truck, Love,

JOSEPH GUMBIS
Canton

I want a Ken doll, a doll house, some Strawberry lipstick and a baby doll. Merry Christmas Santa,

ERIN WILLIAMS
Plymouth

I love you Santa.

ANN VERNON
Plymouth

I want Batman sock 3. And a Big Batman and Robin. I love you.

RYAN SMITH
Plymouth

My name is Cher I am 5. I would like a Oscar the Grouch clock. Love,

CHER WALIS
Canton

I've been a good boy all year and I know all my numbers and ABC's. Please bring me a Fisher Price Adventure Set. Love,

GEFF MACKIEWICZ
Plymouth

Please bring me a teddy bear, a pair of ice skates, size 11, a doll named baby cry for you and a bag full of candy. Love,

MELLONNIE NEWSON
Plymouth

I hope you have a nice Christmas. Please bring me a dirt bicycle.

MATTHEW COOK
Plymouth

I help my mom do the dishes. I help because I like to do dishes and help my mom. I am a good girl, Santa, please bring me a doll. Thanks dear Santa.

SUZANNE WHITE
Plymouth

i would like a sucker.

BECKY GOFF
Plymouth

I love you. I would like a "Race & Chase Race Track" and a "Team America" for Christmas. I have been a good boy sometimes and I get all my math done at school

ADAM BRUTON
Plymouth

I would like a doll, roller skates and my two front teeth. But I would trade all of these for a trip to Arizona to see my cousins Ricky and Cindy.

DEBBIE RASMUSSEN
Canton

I want Computer Command, Crossfire, game, Big trak, Clydes car, Crusher, Mazoo.

JOHN FARRAR
Plymouth

I would like some toys and clothes and books and a Easy Bake Oven, Love,

JACKIE SCHANTZ
Plymouth

I am a good girl. I help my mom and dad. Please bring me something. Thanks,

KRISTA GIRTY
Plymouth

I have been a good boy. I want a toy truck and a drum and a boat. Thanks Santa. Love,

KEVIN MAUL
Plymouth

I have been a good girl. Will you bring me a Sleeping Beauty doll.

HEATHER CONWAY
Plymouth

I have been a good boy. Please bring me some presents. By,

JASON HUBER
Plymouth

I want a bicycle and a drum. I am a good boy. Thanks,

KEVIN DINGELDEY
Plymouth

I have been a good boy. Please bring me an electric train.

TOM DAVY
Plymouth

For Christmas I would like a dirt stunt bike. Thanks Santa,

TONY HALEY
Plymouth

I have been a good girl. I want a Strawberry Shortcake doll and a ball and a kite. Thanks,

MELISSA SMITH
Plymouth

I would like to have an AFX race set, or a Big Trak, or a gun or a rocking chare or a Toun Tour or a snow speeder or a Merry Christmas Santa.

LAMBERTO SMIGLIANI
Canton

I love you Santa.

JILL NUOFFER
Plymouth

I will leave some cookies and milk for you. I love you santa.

JENNY NUOFFER
Plymouth

Motorcycle, Chutes and Ladders.

J. ROZUM
Canton

I would like a Coleco electronic quarter-back. An another one bites the dust record. A Dallas Cowboys football helmet and a racetrack. Merry Christmas.

SCOTT EISENLORD
Plymouth

I would like to have the game Mad and a Nerf football too. Lots of surprises also.

ANDREA DANIELS
Plymouth

I want a remote control car, some Star Wars figures, a Detroit Lions football helmet and Another One Bites the Dust record. Say hi to the family for me. Your friend,

GEOFF EISENLORD
Plymouth

I want skates. Merry Christmas. I love you,

VALERIE WESTLUND
Canton

Merry Christmas, I am Katherin Lee. Bye,

KATHERINE LEE
Canton

I want a barbie car, sewing machine, guitar, superheroes dolls, Snoopy sno cone machine, legos, Strawberry Shortcake dolls. Thank you very much.

JASON SMITH
Plymouth

What I would like for Christmas is, a picture of you, a plate of cookies and milk instead of giving you them. Things for my sister; some dolls.

CANDY MURPHY
Canton

I would like some ice skates and a sled and some Strawberry Shortcake Dolls. Please bring my baby sister Kristine a horse and doll. Love,

TRACI GUTTENTAG
Canton

PS - I have been a good girl.

I would like Barbie Camper and a baby beth doll. She is in a bag box, bring something for my bird and yo ball. Love,

LORI CULLEN
Canton

I want a typewriter and a exercise training bag or a set of drums.

ALEX RAMIREZ
Canton

I know that you have a lot of gifts to deliver, but could you give me one special one? I would like the Fat Wheels Dune Buggy.

WILLIE MUDLOFF
Canton

I have been a good boy. Please bring me a toy garage, trucks, games, and a football shirt. Love,

CRAIG J. BRUNSKOLE
Canton

For Christmas, I would like "Baby Cries For You," Memory, & Baby Buggy. I am trying to be a real good girl.

JENNIFER BUCZEK
Plymouth

I would like a: camera, warm-up suit, Bon Jour pants, and body lingo pants, and cowboy hat, dress pants, two turtleneck shirts, and a watch. Bye now,

CHRISTY MCAVOY
Canton

Please send me a couple barbie dolls. Please send a memo pad to my mom. I please want a pair of Zany Zappers (glass). I love you. Sincerely,

AMY ARMSTRONG
Canton

I want a race track and a train set.

JAMIE KALITA
Plymouth

I was in this contest last year. Wish me good luck. Merry Christmas.

DON JOWSEY
Plymouth

NOW there's more to savings. Just "Check n' Save"® with us.



Starting December 31, 1980,
Down River Federal Savings will offer
checking accounts that earn 5¼% daily interest,
paid and compounded quarterly
with a \$500.00 minimum balance.

Sign up beginning
December 1 for your interest
earning "Check n' Save"®
account with Down River
Federal Savings.

You'll use this account like you
would any checking account,
but it will earn you daily interest
just like a savings account,
including interest on funds for
which you've written checks
until those checks have cleared.
As long as you maintain a
\$500.00 minimum balance,
there's no service charge. Visit
any of our 24 convenient offices
(not available at drive-in offices)
to open your account, or fill out
the coupon and send it in.

Mail this coupon or bring it into the nearest Down River Federal Office.

M _____
FIRST NAME INITIAL LAST NAME

ADDRESS _____

CITY _____

STATE _____ ZIP _____

HOME TELEPHONE _____

SOCIAL SECURITY NUMBER _____

IF TO BE JOINT ACCOUNT, NAME OF CO-OWNER _____

M _____
FIRST NAME INITIAL LAST NAME

YOUR SIGNATURE _____

CO-OWNERS SIGNATURE IF JOINT ACCOUNT _____

Big. But downright neighborly.

Down River Federal Savings

24 neighborly offices to serve you. Home Office: TAYLOR, 20600 Eureka Rd., 285-1010; ALLEN PARK, 6634 Allen Rd., 381-2500, 6770 Allen Rd., Drive-In; CANTON TOWNSHIP, 42448 Cherry Hill, 981-2888, 41575 Joy Rd., 453-1430; CARLETON, 859 Monroe St., 243-6600; DETROIT/REDFORD, 24650 W. McNichols, 531-4753; FLAT ROCK, 28650 Telegraph, 782-1411; GROSSE ILE, 8095 Macomb, 675-8330; INKSTER, 29365 Cherry Hill, 728-1680; LINCOLN PARK, 3528 Fort St., 386-3500, 3461 Fort St., Drive-In, Corner of Dix & Charter; LIVONIA, 33111 Seven Mile, 477-9340; MELVINDALE, 3805 Oakwood Blvd., 382-2600; MONROE, 106 N. Monroe St., 243-6600; NORTHVILLE, 127 Hutton St., 348-8920; RIVER ROUGE, 261 Burke, 841-3100; RIVERVIEW, 17515 Fort St., 285-1010; SOUTHGATE, 13628 Eureka Rd., 285-1010; TAYLOR, 23700 Goddard Rd., 291-3900; TRENTON, 3290 West Rd., 676-2299; WOODHAVEN, 22211 West Rd., 676-1144; WYANDOTTE, 2959 Biddle Ave., 285-1010. *Opens Spring 1981



Member Federal Savings and Loan Insurance Corporation. Your Savings Insured to \$100,000.

Thanks for your patronage in 1980! —Your Crier Carriers



Call 453-6900 for home delivery

Dear Santa

My name is Penny C. I would like a Pretty Curly Doll, pluss a glass animal for my glass animal collection. It is OK if you can not find them. I love you very much.

PENNY CARBONE
Plymouth

I would like a pair of panty hose, Baby Cry and Dry and Tan Barbie. Thank you.

LISA FERGUSON
Plymouth

I want IG-88 rebel soger, FX7 medical droid, Tonka plane, leather gloves, big trak, invader from space and Redline drag race and a bebee gun.

CHRIS VANDERWEELE
Canton

I hope you will like my picture. I would like some gloves, and a watch and clogs.

CARRIE VANDERWEELE
Canton

I know what I want for Christmas. I would like a remote control Transam. Thank you.

JAMES BOSAK
Plymouth

I would like a barbie swimming pool, a pencil sharpener, a label maker kit, a bulletin board, a pair of roller skates, a doll case with a bed and Fresh 'n fancy.

TAMARA ENGLAND
Plymouth

I hope your reindeer don't get sick. If you come to my house I will have a cookie or something for. I would like some new shoes and games.

JENNIFER HARTKE
Canton

I want a bulletin board. And a slot car race set. I will be happy then. And I want my mom to be happy. Your friend,

MORGAN STIDWILL
Plymouth

I hope you can come visit me and my family in Missouri at Christmas. I hope it is a good Christmas. I also hope I get some nice gifts.

SCOTT BENTON
Plymouth

I would like to get a nerf football and new clothes, shirts size 12 and pants size 12 reg blue, please and an electric football game.

TONY SCAGNETTI
Canton

My name is Shanty. Do you like Brandy? This Xmas I'm in a crunch, so please bring me a bunch. I'll have you a lunch, A dandy brunch.

SHANTY TROY
Canton

I would like many things for Christmas such as: a clock radio and toys, but the thing I want most is peace & harmony for girls and boys.

WENDY HIX
Plymouth

I would like some baseball cards and electronic Space Invaders.

CHUCK MCCANN
Plymouth

Thank your for coming every year. Did you like the food we gave you? I want a baby alive care set. I will be looking for you this year.

LINDA ETINGER
Plymouth

For Christmas, I would like the puzzling square, Rublik's Cube and you can always give me candy.

KRISTAL TAYLOR
Plymouth

I would like to have Millenium Falcon and Mattel Hockey Stomper 4x48 wild Mountain set, Match box of the road, Play care Howdy doody, Rchblack porsche Hangman Snoopy.

BRIAN VASKE
Canton

I was a very good girl this year. I would like a Holly Hobbie Oven and some other toys. Love.

CHERI BURNS
Plymouth

I would like a Barbie doll House, and a doll for my little sister. Love.

LAURA LONG
Canton

I've been a good girl. Please bring me the set of strawberry short cake dolls. I love you Santa.

SARAH WHITE
Canton

I want Huckleberry Pie Doll, my own tv set, flowers for my mom, a monkey for my dad. Love.

CARRIE BRYANT
Plymouth

I'm at the age nobody believes in. you, well I do and I'm going to for ever. I want legos and a bulletin board, desk mat and the Millenium Falcon.

BEN STANDISH
Plymouth

I like you. You give neat toys. Can you fix real football equipment? What does your helpers look like? I want drums and real football equipment with real pads. Thanks.

CHRISTOPHER HAYES
Plymouth

I want those weights you put sand in. Real football equipment, Play motorcycle, HOT Wheels, and a Microscope. Thank you.

MICHAEL HAYES
Plymouth

My name is Kristen Champe. I would like a big surprise. Your friend.

KRISSY CHAMPE
Canton

I hope you get me what I want -- alarm clock, candi doll, perfection, baby touch 'n love, Lionel train stuff, yo-yo, juicer blender and fashion plates. Thank you

JENNIFER BRINING
Canton

I want a baby mouse. And a watch. T.V. furniture for my doll house, caryons and a Strawberry Shortcake doll. Baby Cry and Dry doll. Baby Cries for you doll.

KIM JAYROE
Canton

I'm Cindy, Im 5 years old. I would like to have a new seat for my bike and a pari of pajamas with the feet in them. I will leave you some cookies and milk. I love you,

CINDY HOLTON
Plymouth

I would like a sport and shave ken barbie fore Christmas and a baton, and I hope that we have a lot of snow this year, have a nice Christmas.

JILL CURRIE
Plymouth

I would like two or three models of horses. Beware the Spider and Muppets secret doll house and alot more but I won't have enough room to write it.

KIM CURRIE
Plymouth

WARMTH!

The Way you Like it

by

Damon



LENTS

MEN'S CLOTHING

Mon.-Fri.
9:30-9 pm
Sat. 9:30-6
Sun. 12-5

798 PENNIMAN
Across from Kellogg Park
FREE PARKING IN REAR OF STORE
Free Gift Boxes

453-0790
453-5260



THE AIRPLANE STORE WITH A WHOLE LOT MORE

Want to Fly Models
Inside? Call us About
Our Indoor Model Flying

**Dungeons &
Dragons
Games & Supplies**
20% Off

Till Dec. 25, 1980

Wayne Hobby

34816 Michigan Ave.
Near Wayne Rd. • Open 7 Days
721-0700

Florence Antiques

Specializing in Pattern Glass and Collectables
Limited Selection of Furniture
Pewter, Copper and Brass
Hours by Chance

You'll Find us Adjacent to:
Plymouth Glass Co.
1382 S. Main at Byron
1 block N. of Ann Arbor Rd.
Plymouth 453-3434

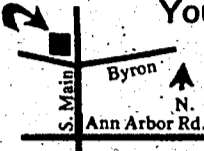



Laurel FURNITURE

Amazing Savings on
Antique Brass finished
Lamps

At a Many Years
Ago Price!

\$29.95

584 Ann Arbor Trail
Plymouth 453-4700
Open Daily: 9:30-6pm
Thurs & Fri til 9pm

*Jewelry to
enhance
to Delight*

14 Kt Gold
Earrings 20% off

All Watches
30% off



Gold Chains sold by gram weight.

Delta

DIAMONDS
SETTERS
& JEWELERS

485 S. Main St.,
Plymouth
455-1220

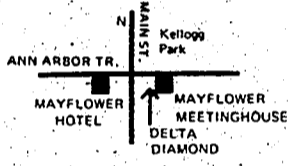

Handyman Gift Ideas

SAVE \$19*
SKILSAW

6 1/2" CIRCULAR SAW



MODEL 534

- A lightweight and compact saw that can be used for most home projects
- 5000 RPM, no load speed
- 1 1/2 HP, 9 amp burnout protected motor
- Equipped with combination blade and blade wrench

ONLY \$39⁹⁹

*Based on Mr's Regular Suggested Retail Price

SAVE \$8*
SKIL

SANDCAT™ SANDER



MODEL 593

- Combines the ease of control of an orbital sander and the low vibration characteristics of a belt sander
- Ball and needle bearing construction for dependability
- Exclusive locking lever makes changing belts easy
- Double insulated for added safety

ONLY \$49⁹⁹

*Based on Mr's Regular Suggested Retail Price

**See our complete selection
of Hand & Power Tools for
a Gift Appropriate for
Handyman or Pro**

HU 2-0735



Flagerie
Hollister
Wood

THERE IS A MATERIAL DIFFERENCE

We Are 1 Mile East of Downtown
Always Plenty of Free Parking Available

WE'RE MORE THAN A NICE PLACE TO EAT

Celebrate New Year's Eve
with your friends at the Hillside



The year deserves a special beginning. Warm fires blazing, great foods, and reservations seated promptly and live entertainment. We'll make sure your 1981 starts happy, after all, this is our 47th year of serving you fine New Year's Eve dinners. Callus for information. May your New Year be all you've hoped for.

Call:
453-4300

The Hillside Inn

41661 PLYMOUTH ROAD, PLYMOUTH 453-4300

Special Gifts of quality...



Boots
Tony Loma • Justin • Acme
Larry Maham • Dan Post
Rangler • Texas

Hats
Stetson • Resistol • Bailey

Jackets & Vests
Gerry • Comfy

EMBERT'S SADDLERY & WESTERN WEAR

217 N. Main 455-1800

Dear Santa

Dear Santa I love you. I would like a big doll house with furniture and people and a big Pink Teddy Bear and my friend Jenny.

MICHELLE HERNANDEZ
Canton

Can I have Fresh and Fancy, baby cry and dry, baby cries for you. Thank you Santa.

KRISTIN HONECKER
Plymouth

All I want for Christmas is peace in the world and the hostages in Iran to get out. Love.

JENNY BRYANT
Plymouth

My name is Kelly Grace and I'm 7. I have two brothers. I would like a set of pom poms; Crazy Creators and a play Refrigerator for Christmas. Thank you.

KELLY GRACE
Canton

I want some records and some Lipgloss for Christmas. When you come down our chimney it is dirty so be careful. Love.

HOLLY MUDRI
Canton

I would like these games, Pay day, trouble, Bonkers, Mr mouth, Boggle and I would like you if you bring laygos. Love.

CHRISTY PARKER
Canton

I would like some clothes and a bowling ball and bag and the book Are You There god, Its Me Margret.

KARA HAARALA
Plymouth

I would just like enough money to buy my family presents for Christmas.

JAY TOMOLAK
Plymouth

Please bring me a control car. Thank you.

JOHNNY GARGARO
Canton

I would like a expert Builder lego set. And also a petoske stone. And a new hamster cage part for my hamster.

JULIAN SELL
Plymouth

I think I have been very good this year and here are a few things I want. 2-XL, an educational robot and some big cute, fuzzy stuffed animal. Love.

LYDIA HUMMEL
Livonia

I would like Baby Wipe Your tears, a play car you can drive. A play kitchen set and something for my brother that I love very much. Love.

ANNMARIE MCCORMICK
Canton

I would like Marzon and Night-Glo Alley and Speed Burners. Also I would like a fun-book to keep my busy in the winter. I hope everyone has a happy Christmas. Thank you.

TIM CULLEN
Canton

How is your wife? I have a parakeet named Dewey. Bring him a Woodstock doll and seeds. You can peek under his cover but don't open his cage. I would like a Muppet's Secert Doll House, a nightie, food set, and an appliance set. Love.

AMY WESTERHOLD
Plymouth

I would like a big trak. Thank you.

JODY MILLER
Canton

I would like a pair of Sasson jeans. Thank you.

DAWN MILLER
Canton

Please I would like Merlin and the Grease Record, and a pear of jeans, and some more records, and a blue blouse, and some socks and some dolls too, and some more clothes, and some Ribins, and a doll highchair, dress-up boots, and a game. and shirts and two more pears of Jeans. Love.

MELANIE JONES
Canton

I would like a barbie swimming pool, a pencil sharpener, a label-maker kit, a bulletin board, a pair of roller skates, a doll case with a bed, Fresh 'n fancy.

TAMARA ENGLAND
Plymouth

I would like a Tub Doll, Rubber Ducky, Barbie House and a Horn for my bike and a Puppet and a Barbie horse.

MANDY ENGLAND
Plymouth

I want a lot of Star Wars toys.

DENNIS FINNEGANCD
Plymouth

Hi, my name is Lisa Pata and I'm 13 years old. I would like a sewing machine for Christmas most of all.

LISA PATA
Plymouth

I want a hamster for Christmas and some hamster food and a baby doll with clothes. I know I can not have roller skaters because I have been sick. Love.

DIANA KONARSKI
Canton

I would like a lot of toys for my new baby brother, and a sewing machine for me and a bike for me. I love U.

MEGHAN MAYCOCK
Plymouth

Dear Santa, I would like some pretty clothes. And peace on earth to all mankind. I would like a woodburning set. Love.

NATALIE MAYCOCK
Plymouth

I would like Star War man. I want a Darth Vader ship and some records. I would like some computers. Thank you. Love.

MATTHEW VOLZ
Canton

For Christmas I would like a head to head electronic football game, some books and a soccer ball. Thank you.

HOAN VUONG
Canton

I would like a tent and a Mighty Mouse punching bag and some Lincoln logs.

JESSICA GIBBONS
Plymouth

I want speed way race and chase. And a ten speed like. I would like some snow for Christmas Eve.

CHRIS TURNBELL
Canton

MARIA'S ITALIAN BAKERY HOLIDAY DELIGHT'S

**Package
Liquor**



Unbaked family style Pizza
from 6 to 24 piece sizes

Holiday Baked Goods

Cannoli • Cookies • Donuts

Cakes • Cream Puffs • Cheesecake

Bread • Pizza-Bread

Deli

Party Trays • Subs up to 6 feet long

Meats • Cheese • Salads

Italian & Domestic lunch meats

Full assortment of cheese

Homemade Spaghetti Sauce

Lasagne & Stuffed Peppers

CANTON
115 Haggerty
(corner Cherry Hill)
981-1200

WESTLAND
38411 Joy Rd.
(Joy-Hix Shopping Center) 455-0780

NOVI
41652 W. 10 Mile
(Corner 10 Mi. & Meadowbrook)
348-0545





STAN'S MARKET

464-0330
38000 Ann Arbor Rd.

HOURS

Mon. thru Sat.
9 AM to 9 PM
SUNDAY
10 AM to 5 PM
QUANTITY RIGHTS
RESERVED
PRICES GOOD
THRU 12/21/80



FRESH HOMEMADE POLISH KIELBASA	\$1.58 LB.
USDA CHOICE BONELESS SIRLOIN TIP ROAST	\$2.38 LB.
LEAN, MEATY, FRESH SPARE RIBS	\$1.38 LB.
USDA CHOICE SEMI-BONELESS STANDING RIB ROAST	\$2.98 LB.
FRESH GROUND ROUND	\$2.08 LB.
GRADE A TURKEYS ANY SIZE-10 LBS. & UP	88¢ LB.

	FLAVORFUL BONELESS ROLLED Rump Roast \$1.98 LB.
TASTY TENDER Eye o' Round Roast	\$2.58 LB.
BONELESS TOP ROUND Family Steak	\$2.58 LB.
	BUTCHER BOY Boneless Ham \$1.69 LB.
	FARMER PEET'S HI STYLE Semi-Boneless Ham \$1.29 LB.
	ROTUNDA Semi-Boneless Ham \$1.69 LB.

US No. 1 IDAHO Potatoes \$1.79 10 LB. BAG	LARGE FRESH Broccoli 89¢ BUNCH	Cucumbers, Green Onions & Red Radishes BY THE BUNCH 6 oz. wt. 4/\$1 MIX OR MATCH
--	---	---

MELODY FARMS SOUR CREAM (PINT) 16 oz. wt. 79¢	BIRD'S EYE COOL WHIP 8 fl. oz. 69¢
--	---

ST. REGIS 9" WHITE
Paper Plates
100 COUNT
99¢

LARGE
Nestle Morsels
12 oz. wt.
\$1.89

MAXWELL HOUSE
COFFEE
Reg., ADC, or Elec. Perk
\$4.99
2 LBS.

LIBBY'S
Tomato Juice
46 fl. oz.
79¢

STAN'S BONUS COUPON

 **Hellman's Real MAYONNAISE** **\$1.18**
32 fl. oz.

Limit 1 with \$15.00 Grocery Purchase
Coupon effective thru Sunday, Dec. 21, 1980

ASSORTED FLAVORS
Faygo Pop
1 LITER
3 / \$1.00
PLUS DEP.

CAMPBELL'S
Pork & Beans
28 oz. wt.
2 / \$1.00

STAN'S DISCOUNT PRODUCE CENTER

38741 ANN ARBOR RD., LIVONIA • 484-0410

HOURS

Mon. thru Sat.
9 AM to 7 PM
CLOSED SUNDAY
QUANTITY RIGHTS
RESERVED
PRICES GOOD
THRU 12/21/80

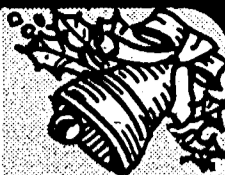

PG. 29 THE COMMUNITY CREEK: December 17, 1980

**Cucumbers
Green Onions &
Red Radishes**

BY THE BUNCH (6 oz. wt.)

4 / \$ 1.00

MIX OR MATCH

Poinsettias

\$ 1.99
& UP



**Party
Trays**

\$ 1.65
PER
PERSON

YOUR CHOICE OF LUNCHEAT,
CHEESE, SALAD, AND BREAD
MIN. 10 PERSONS

**HOLIDAY
FRUIT
BASKETS**

WICKER OR FRUIT BOWLS



\$ 5.99
& UP

DELI SPECIALS

FRESH Kielbasa	\$ 1.58	LB.
ECKRICH SMOKED Sausage	\$ 1.99	LB.
POLISH Kielbasa	\$ 1.99	LB.
COLBY & MUNSTER Cheese	\$ 1.99	LB.

IDAHO BAKING

Potatoes

\$ 1.79

10 LB. BAG



STAN'S DISCOUNT BEVERAGE CENTER

PRICES GOOD THRU 12/21/80

OPEN SUNDAYS 12-5

HOURS: MON-SAT 9-7
NOW OPEN SUNDAYS- 12 to 5
38001 ANN ARBOR RD.
DIRECTLY ACROSS THE STREET FROM
STAN'S MARKET
484-0436

YOUR CHOICE

- 7-UP (Reg. or Diet)
- Canada Dry Ginger Ale
- Barrel Head Root Beer
- Orange or Grape Crush



8-PAK

\$ 1.68

PLUS
DEPOSIT



1 LITER

**Canada Dry
Ginger Ale, Soda,
or Wink**

2 / 88¢

PLUS
DEPOSIT

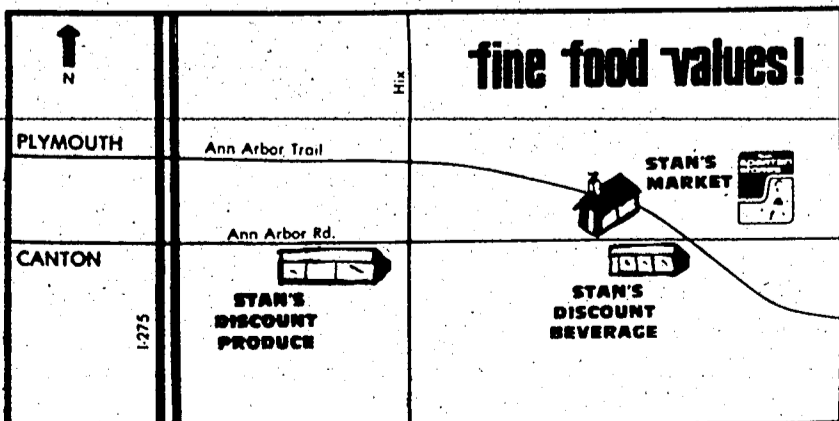

WE ARE NOW OFFERING

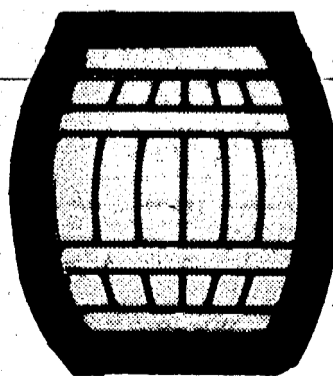

KEGS

OF-YOUR-CHOICE IN BOTH SIZES

- 1/4 Barrel
- 1/2 Barrel

**LOW, LOW
PRICES**

RENTAL EQUIPMENT AVAILABLE

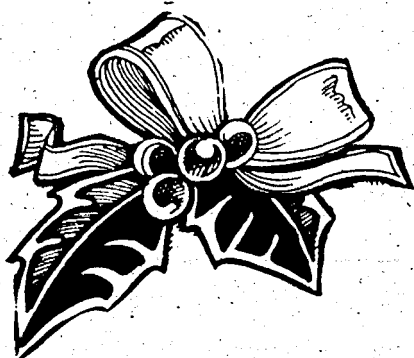

HARVARD

It's a Christmas Celebration
at
HARVARD SQUARE SHOPPING CENTER

Now thru Saturday
Visit Mrs. Santa and Her Elf
Saturday, December 20th
From Noon to 3 p.m.
(near Cambridge Furniture)

Mrs. Santa has FREEcandy for the children. Plus, to the first TWENTY adults presenting her the coupon below there's "Christmas Discount Make Believe Money" worth \$10 off merchandise. Also, many of our fine stores and services have loads of Christmas Joy for YOU.

Happy Holidays
From the Merchants
at Harvard Square Shopping Center
COUPON

Present this coupon to Mrs. Santa on Sat. Dec. 20th from Noon to 3 p.m. for "Christmas Discount Make Believe Money". You must be at least 18 years old. Valid to the FIRST TWENTY ADULTS PRESENTING COUPON.

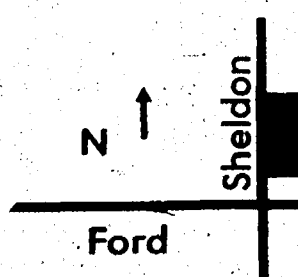

HARVARD SQUARE SHOPPING CENTER

Ford Road at Sheldon Road

Professionally Managed By: the hayman company

A Holiday Greetings from Family Physician Evans John Farres D.O.

Harvard Square Shopping Center
6050 Sheldon Rd.
Canton Twp., Mich. 48187

Hours
Mon. 11-9
Tues., Thurs., Fri. 11-6
Sat: 9-12

459-5500

Auto policy expiring?

You may qualify for Allstate's Good Driver Rates and be entitled to some discounts, too. Call and compare.

Allstate
You're in Good Hands
Allstate Insurance Co.
Northbrook, Illinois

CANTON ALLSTATE HARVARD Square 5924 Sheldon Rd. **453-7100**

MASTERO LIGHTING

A Christmas De' Light

1/2 Off List Price
All-Art Glass Tiffany Shades
All-Table, Desk, and Piano Lamps

Christmas Gift Special
"The Little Lamp"
Natural Capiz Shell and Brass
12 in. Tall-60 Watt \$12.95

5848 North Sheldon
Canton, Mich 48187
459-3170

Mon-Wed 10-6
Thur & Fri 10-8
Sat 10-5

SQUARE

Sheldon Rd.
at Ford Rd.
Canton

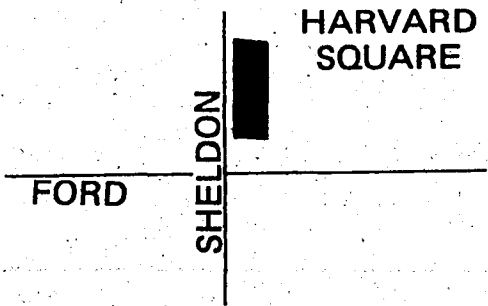

HARVARD SQUARE PG. 31

THE COMMUNITY CRIER: December 17, 1980

Make Your New Year's
Reservations Now!

at

Cyprus Gardens

Family Restaurant
5830 Sheldon Rd at Ford
Harvard Square • Canton

Entertainment Featuring
Greek, American & Hungarian Music

\$25

A Couple
(Includes Dinner)

BANQUET FACILITIES
SEATING UP TO 150

- Breakfast Specials
- Businessman Lunches
- Beer • Wine • Cocktails

Every Friday
FISH \$3.25

All You Can Eat

Mon.-Sat.
8 am-11 pm
Sun.
8 am-9 pm

455-7220
455-7222





Special Christmas
Permanent

**SENSOR
PERM**
\$33⁰⁰

Regularly \$48.00
(Short & medium Only)

Ears Pierced Free
With Purchase of Earrings
All for \$3.99
Purchase now for Christmas
Gifts and We'll Pierce later.

In Westland

De' Cut

6643 Wayne Rd.
Westland Plaza
721-0960



In Canton

Peacock Room

Unisex Styling Salon
459-4280

5800 Sheldon at Ford
Harvard Square, Canton
Open til Midnight Thurs.
Sunday 10-5

Season's Greetings

from

"Your Holiday Travel Center"

- Gift Certificates
- Airline Tickets
- Cruises (Offering
Many 1981 Winter
Cruise Specials)
- Honeymoon
Packages
- Hotel
- Car Rentals
- Commercial
Accounts



A Full Service Agency Offering Personalized
& Professional Agents

Who Want To Work For You

**HARVARD SQUARE
TRAVEL SERVICE**

Hrs.: Mon.-Fri. 9:30-5:30
Sat. 10-2
Evenings by Appt.

Phone: 459-2010

**SANTA
LOVES
YOU**

SANTA LOVES



YOUR NAME

on a personalized t-shirt

- CAPS
- LARGEST SELECTION OF
TRANSFERS
- CUSTOM LETTERING FOR
SCHOOLS, CLUBS, TEAMS,
GROUPS, BUSINESSES
- WE PRINT ANYTHING

X-PRESSIONS

6064 Sheldon Rd.
Harvard Square
Canton

WE FEATURE TRANSFERS AND LETTERING FROM 

Dear Santa

For Christmas I would like a pair of Bonjour jeans, and a top to go with it, also I would like an aquarium, some books and albums.

KATHY SATTLER
Canton

I want peace, love and friendship in the world. And please try and help the hostages come home.

BROOK BOGGS
Ann Arbor

I want a game called Simon and some clothes. I really don't know what I want. I want to give everybody in my family something that they will like. Have a happy and holy Christmas.

LISA CERVANTES
Canton

I'd like a virty-bird, big-trak, Micronauts Star Wars things, skates, remote controlled car, train set, and a fun Christmas with my family. Sincerely,

JIMMY IVON
Canton

My Christmas wish is that everyone in the whole world to have a very merry Christmas! Your friend,

AMY COKER
Plymouth

I would like a fish, stickers, and a tape Zanadu, candy, dolls, a hamster, a big hello kitty, pom poms, a poster, a teddy bear, a crayon pin, and games. I am 9 years old.

BETH CUNDIFF
Plymouth

I've tried my hardest to do my best in school and at being good. Please bring me a pair of ice skates and a football. Thanks,

GREG MACKEIWICZ
Plymouth

I would like for Christmas a vest, Easy Bake Oven, doll, electronic game, socks, Dr. Drill in Fill, watch, Moon Boats, baseball hat, many, many, many more stuff!

CAROL PICTILA
Mich.

I want team America super stunt dirt bike and the Night Before Christmas coloring book, a crayola caddy and a fresh in fancy.

SHEILA CLIMIE
Plymouth

I hope you are having a good time, there are lots of things I would like, two things I want is Crayola Caddy and a Fuzzy picture. Thank you,

SHARLENE C. LIMIE
Plymouth

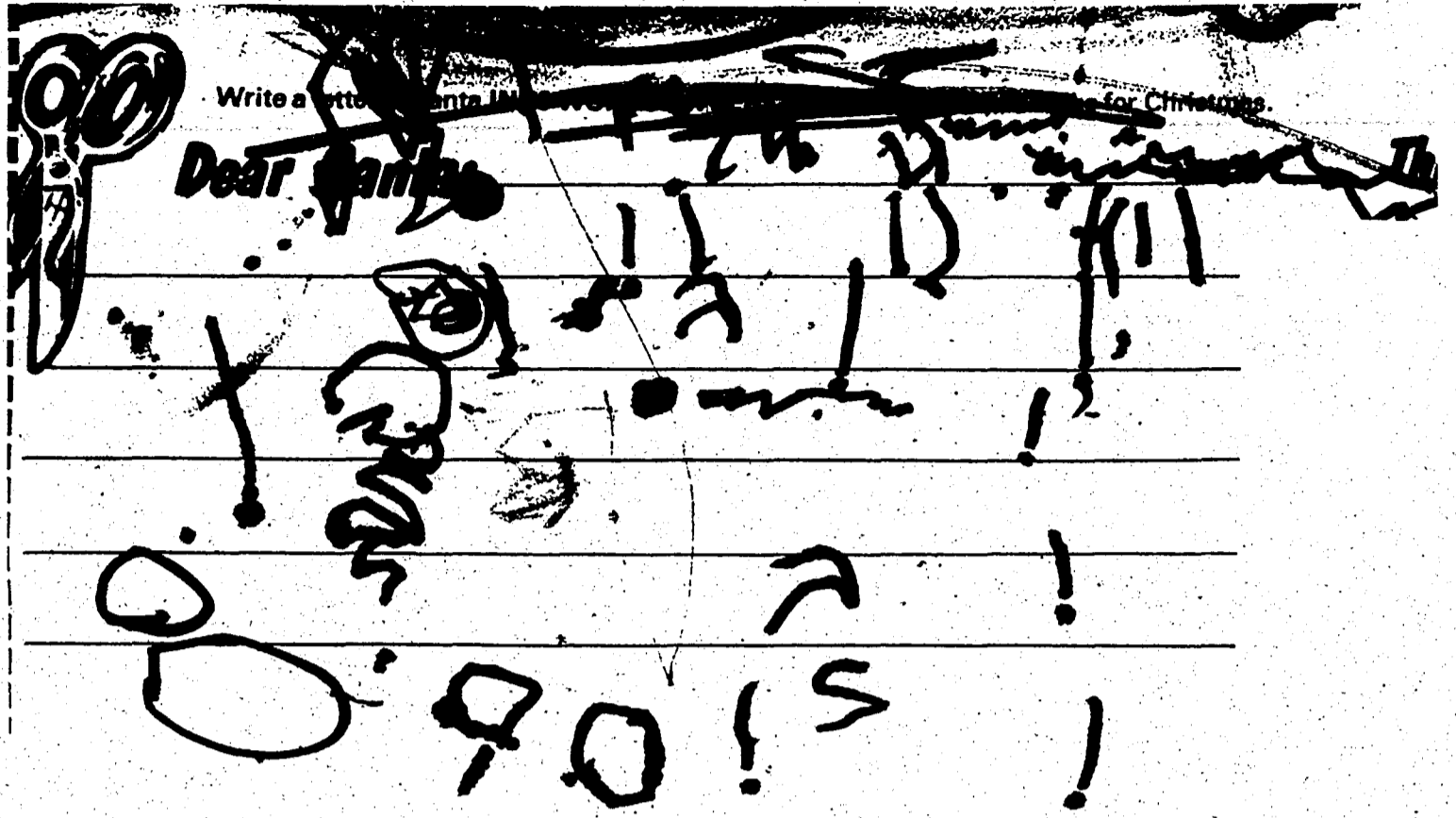

THREE-YEAR-OLD Sonya Semion, of Canton, knows Santa can understand her wishes, despite her less-than-standard penmanship.

I want a snowman and a cheerleader suit. Beautiful Brbie Dream House with furniture, ventriloquist, colls clown, organ, drums, Ronald, My Friend Snoopy.

CARRIE REZABEK
Plymouth

Please bring me a candy cane, cosmetics, doll and jewelry. Merry Christmas. Your cookies will be waiting from Amy.

AMY POLLACK
Plymouth

I like you Santa. I try to be good. I would like: Sew Easy, doll with rocker and baby. My sister Kim wants Snoopy with Clothes.

JILL J. CZAPLICKI
Canton

I would like a new hockey stick and the game Run Yourself Ragged. I also would like some snow. So I can use the skis I got last Christmas. Love,

JOHN RAPP
Plymouth

Since I'm studying about Haika. I made one up for you! Roller skates and books are just a start of my list for my Christmas wish!

ELAINE ZAHN
Plymouth

I have been good all year. I help my mom and dad. Please bring me a doll. Thanks Santa,

KAREN GIFFIN
Plymouth

I like you I want a Barbie and Ken doll and a pink corvette, a new belt. Love,

MELISSA OLSON
Plymouth

Please bring me a 4-wheeler bike. I've been good. My 3-year old brother wants a golf course. You will find your milk and cookies by the fireplace. Love,

GEOFFREY M. KANDES
Canton

A guinea pig, candy canes, candy bars, drums, yarn, stuffed animals, books, malt balls, hamsters, gerbils, gold fish and bubble gum. Mery Xmas.

KELLY TROTTER
Canton

I would like a pair of earrings and some stuffed animals, a camera and a typewriter and macrame owl kit and a art kit and the most important is a safe Christmas and a happy Christmas.

ANN MARIE ETTENHOFER
Ann Arbor

Please bring me wipe your tears baby and make Johnnys grandpa better. Love,

KRISTY GATTOZZI
Plymouth

For Christmas I want a Dolly that looks like a real baby and some clothes for her to wear. And a little oven So I can bake a pie.

NICOLE DUGAS
Canton

I love you Santa, I've been eating my dinner. I want a lots of toys for me and Danny, Love,

TONYA FOX
Plymouth

Please make me a Miss Piggy doll for my collection. Also Moppets Secret Dollhouse, Mickey Mouse Taling toothbrush, magical musical thing, Strawberry Shortcake shoppe. Love,

HEIDI WILDER
Canton

I want Criss-Cross Crash and a race tack and people from the Empire Strikes Back. I also want a stuffed bear for my sister when she gets here.

MIKE ROFF
Canton



generations

a children's boutique

a unique collection of clothing, gifts, accessories & toys for ages 0-14.

Oshkosh — Izod — Absorba
Dijon — Calvin Klein
Petit-Bateau — YSL

Holiday Hours
Mon.-Thurs. 10-8
Fri. 10-9
Sat. 10-6
Sun. 12-5

337 S. Main

662-6615

Ann Arbor

Come visit Santa...

Moms, beat the Hustle-Bustle of the Malls

Have your Childs Picture taken with Santa!

Now thru Christmas

We have everything you need for a beautiful Christmas

- Christmas Arrangements
- Poinsettias & Holly
- Fresh or Artificial Wreaths
- Door Swags
- Gifts
- Trimmings
- Cards
- Fresh or Dried Flower Arrangements

We deliver to 60 suburbs of Detroit's TeleFlorist

Donna and Lou's
Hallmark and Florist

Open 7 Days

349-2380

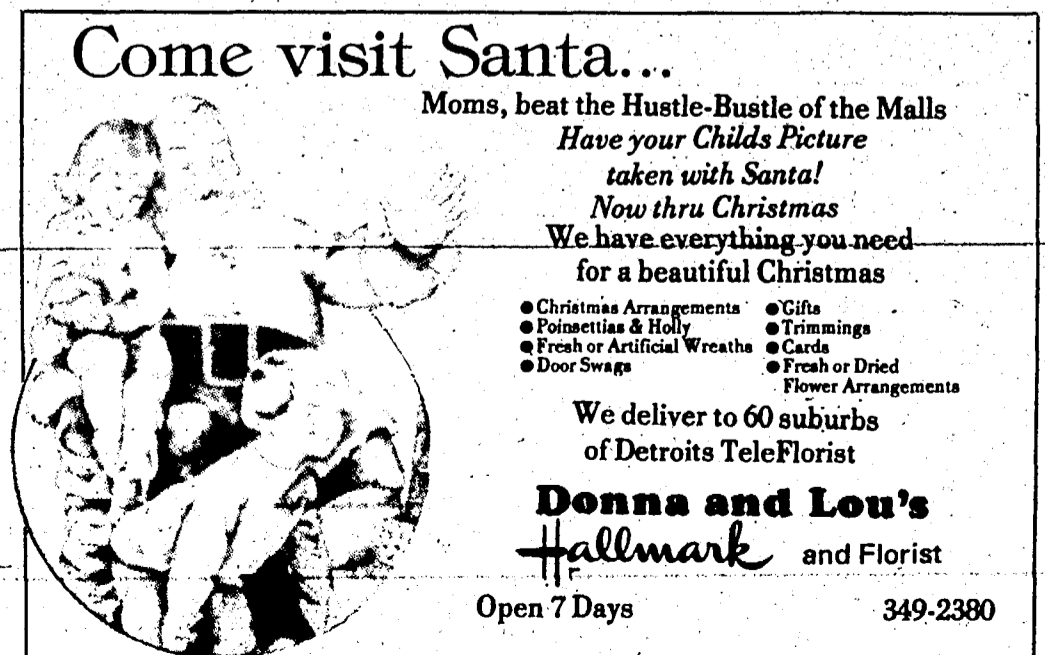

THANK YOU FOR BEING OUR CUSTOMERS

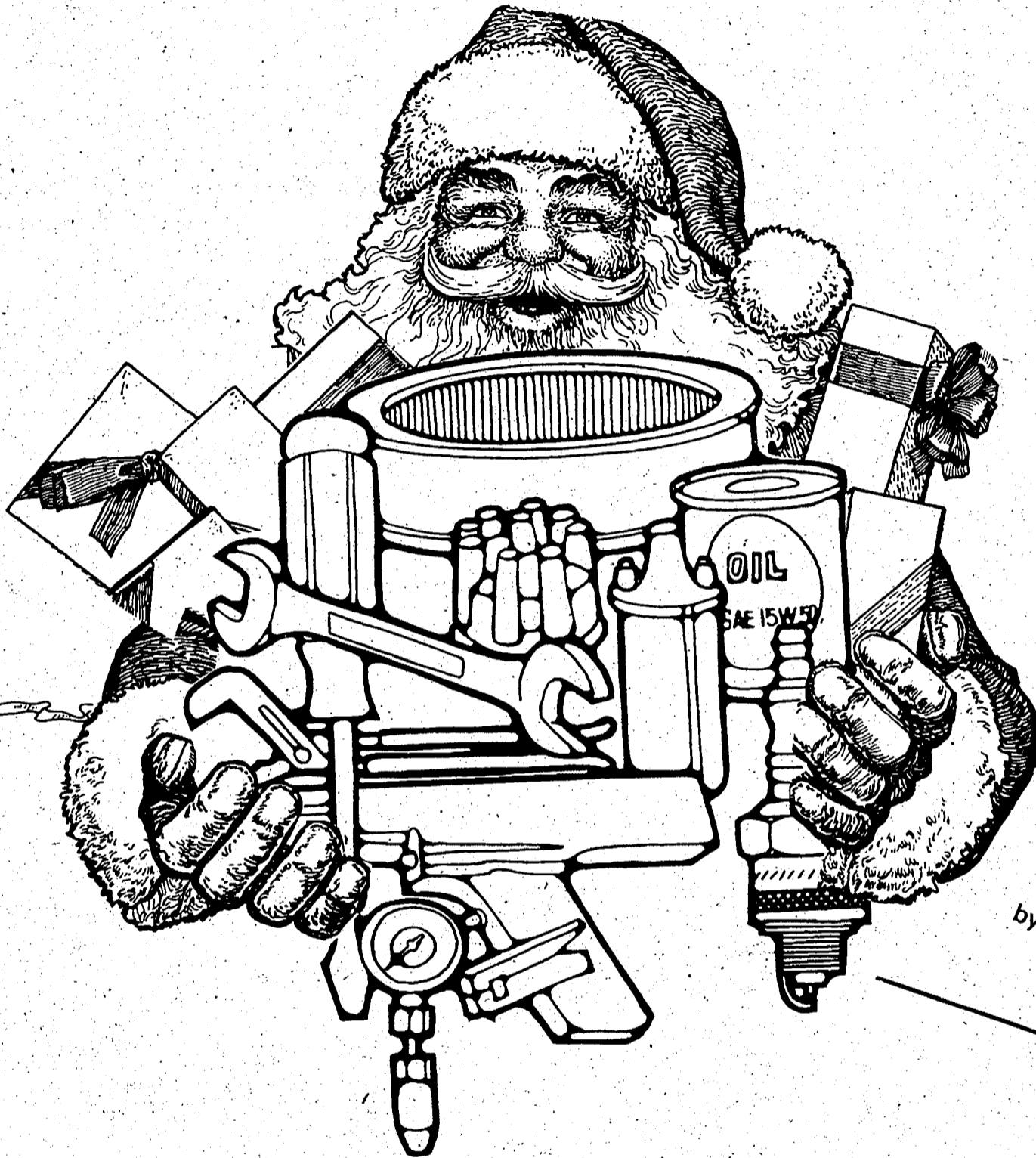

EARN
YOURSELF
AN EXTRA
10%
Discount
by Mentioning
this Ad

**Buy Your Quality Auto Parts
from
Linwood Auto Supply**

42331 Ann Arbor Rd near Lilley
Plymouth
455-7900

Make Your Car Happy for the Holidays!

Plus

Dear Santa

I want a truck and Star War toys and a puppet. Love,

DANNY FURMANEK
Canton

For Christmas I would like James Galway's record, Man With the Golden Flute and a real Christmas tree.

KRISTEN STRICT
Canton

I would like some records and some books. I would also like a pencil set, I hope you have a very merry Christmas!

DAN LOCKWOOD
Plymouth

I would like to see more peace, love and joy in the world today. Also I would like a few gifts for myself and my family. Thank you.

MICHAEL SMITH
Plymouth

I would like for Christmas, a super stunt dirt bike and some zip up pajamas and an electric football game and a hockey electronic game.

CHARLES RHOADS
Canton

I would like in the whole wide world peace for everyone. And a Merry Christmas for everybody. And toys. Some roller skates and electronic space invaders and a stereo record player with two records.

CHRIS ANGELL
Plymouth

If you would pleased get me a ten speed bike, that would be fine. Signed your 5th grade friend.

SHERRY SWEENEY
Plymouth

I like Christmas because I like to decorate the Christmas tree. Also that my family is together. But mainly because I like to give relatives gifts. Best wishes,

VIRGINIA SWIECKI
Canton

Please bring me a tape recorder, Merlin, and Operation game. I like you Santa. I will try to be good. Love,

ALEXIS RICHARDS
Plymouth

I am 4 years old and I am a girl. I want a dolly baby so I can dress her. I want dolly pops, a Barbie case and Mickey Mouse talking telephone.

KARIN KANGAS
Canton

For Christmas I would like a radio so I can play music. I would like Fresh-n-Fancy so I can put on make-up, and some nice clothes and earrings. Love,

KRISTIN KANGAS
Canton

I wish you a Merry Christmas. I would like a Barbie doll house, dolly pops, speak and spell, and pottery craft, and a marching band for my brother. Love,

TRACY GRIMALDI
Plymouth

A soft baby doll, cards, puzzle, makeup, radio. Love,

LAUREN M. CASSADY
Canton

I would like my first game and Major Jorgen and underoos, book, Old Maid Cards. Good bye,

ERIC A. TOMEI
Canton

DEAR SANTEE:

*My name is Shanty
Do you like brandy?
This Xmas I'm in a crunch,
so please bring me a bunch.
I'll have you a lunch,
a dandy brunch.*

Shanty Troy

How are you doing? I am fine. I hope you have a happy Christmas. I would like AFX snake track. Rubix cube, Stop Thief, Atari and Clue: Merry Christmas.

CHRIS CALLOR
Canton

An AM FM clock radio, a skirt, a blouse, a beige velour shirt, a pad of note book paper, a sweat suit, and a new ice skating skirt.

HEIDI EHRENFELD
Plymouth

For Christmas I would like a lot of things. Here are some of them, A ten speed, Connect Four, Contact Lenses, and a lot more. Sincerely,

SUSAN POSTELL
Plymouth

Will you please bring me Babby Alive and Chew Suzy Chew and Apple Dumpling. I try to be good I am doing good in school. Will you try to bring my sister and brother and my mom and dad what they want. Thank you,

STACIE LICHON
Canton

Please may I have a guitar, a calculator and a zoom broom? How is Mrs. Claus and Rudolph? I'm fine. Love,

GINNY C. REGEHR
Plymouth

This year I want snow, cold weather and ice so I can use my ice skates. Love,

MATTHEW HARFOOT
Plymouth

I would like a guinea pig and everything that goes with it, a big Pink Panther and Sylvester, a soccer ball and a hamburger-bean-bag. Your fan,

DIANE SANDS
Canton

I want a Mulineum Fulcan, Tomy Hit and Missle, a stomper, a team America super stunt bike and the 8 tract tapes: The Game by Queen, Dream Police by Cheap Trick.

MIKE ZAWODZK
Canton

For Christmas I'd like a ten-speed bike, money, tunnels to connect on hamsters cage, tv, pocket camera, dollhouse, big bounce rubber intertube, moppets secret doll house and Dress Me Snoopy.

KELLY OLDS
Plymouth

I would like to win this contest and an electronic soccer game. A few Star Wars figures and a radio control car, a soldier set and some surprises.

CHRIS WIDDICK
Canton

I would like a Snowspeeder, a tomtom, a jeep CJ snake track, some models, a tape recorder, fat wheels, radio controlled jeep and some money.

MIKE GLOBKE
Canton

I want more money for the poor, and clothes and food. And also pleased do help the sick! Kisses and huggs,

KATRINA KARASSY
Plymouth

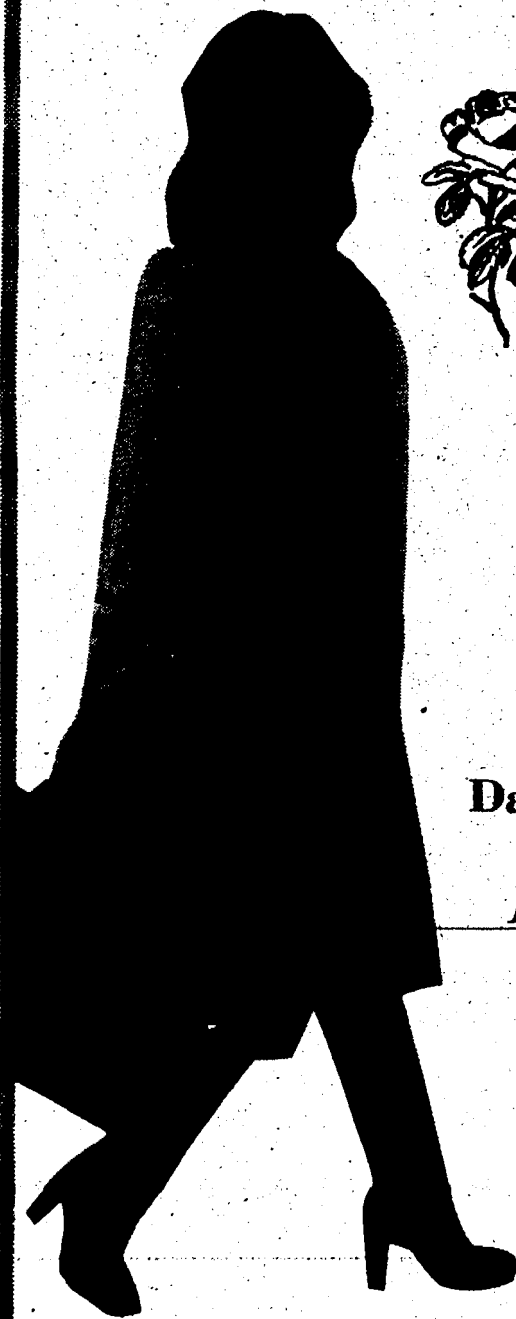

The Yellow Rose of Plymouth

20% OFF
all our Fall Holiday
& Early Spring
Coordinates

Groups by Personal,
Dana Point, Caper Mates

Now through Dec. 20

470 Forest Place,
Plymouth,
Phone - 455-6960

Grandchildren

<i>Where are the children? Where have they gone? I once heard their laughter. I once heard their song.</i>	<i>Bring me the dolls. Wind up the train. They're coming home With children again.</i>	<i>I'll polish the table. I'll place every chair. With joy in my heart. With the children there.</i>
<i>There are toys in the attic. Toys in the hall. Toys in big boxes For children so small.</i>	<i>Find the toy soldier Once shiny and new. Bring me the tea set Of China so blue.</i>	<i>Where are the children? Where have they gone? Once more I'll hear laughter. Once more I'll hear song.</i>

Christmas 1980 Cynthia Cummings

Cynthia Cummings, Author of "Christmas Ribbons" will be autographing copies of her book on Dec. 20 between 11-5 at the Green Thumb. Previously purchased books will also be autographed.

Green Thumb and **THE CHRISTMAS STORE**
470 Forest Avenue Plymouth • 459-2323

Bee Jays
KITCHENS

Dial 455-8010

We Deliver
628 S. Main
Plymouth, Michigan

THE FINEST IN
FAST FOOD SERVICE

A COMPLETE FOOD SERVICE -
TAKE OUT • DELIVERY • CATERING

PIZZA • DINNERS • SPAGHETTI

Buckets of Chicken, Shrimp, Fish
SMORGASBORD • FRENCH DIP • SIDE ORDERS
Mon-Thurs 4pm-12pm; Fri 3pm-2am
Sat 3pm-2am; Sun 3pm-12pm

10% OFF ANY ORDER Good thru Dec. 31, 1980



Help is just a phone call away

Dial-It Shopping

PG. 35 THE COMMUNITY CREEK December 17, 1980

ALARMS

MIDWEST ELECTRONIC SECURITY
36343 Ford Rd.
Westland
721-3894
Commercial and residential Security System installed
Auto Alarms • Keyless push button alarm system • Free estimates

APPLIANCE REPAIR

BILL & ROD'S APPLIANCE
15076 Middlebelt
Livonia
425-5040
• Maytag Dealer • Repair all makes & models major appliances
• Parts available • Whirlpool • Maytag • Kenmore • G.E.
• Used Appliances.
Mon. thru Sat.

AUTO REPAIR

DENNY'S SERVICE
1008 Starkweather
Plymouth
453-8115
Front end work • Tune Ups • General repair • Certified Mechanics • \$28.00 Computer Hook-up plus 4 minor adjustments.

BAKERY

MARIA'S ITALIAN BAKERY
115 Haggerty - 981-1200
38411 Joy Rd. - 455-0780
• Square Pizza • Hot Italian Bread • Sausage • Baked Goods • Cannoles • Cake • Italian Lunch Meat • Beer • Wine.

BATH BOUTIQUE

FAMILY BATH BOUTIQUE
895 Wing St.
Plymouth
459-1680
• Remodeling • Repairs • Bath Accessories • Medicine Cabinets • Vanities • Bath Carpeting • Shower Curtains • Wicker & Wood Accessories.

BEAUTY SALON

DD HAIR FASHIONS
44706 Ford Rd.
Canton
455-9330-453-6540
455-9331-453-6640
Specializing in
• Perms • Precision & Permetric Hair Cuts • Manicures
Total Redken Hair Salon

BOOKSTORE

PLYMOUTH BOOK WORLD
2 Forest Place
455-8787
844 Penniman
455-6600
Expand your horizons • Read a book today • Unique childrens selection • Discriminating Magazine corner • Refreshingly different cards & gifts

LIST YOUR BUSINESS HERE
453-6900

BRIDAL SALON

GENEVA'S OF PLYMOUTH
17 Forest Place
Plymouth
455-4445
Wedding Gowns • Accessories • Cocktail Dresses and Prom Gowns • Appointments Available
Mon.-Tues.-Wed.-Sat.
10:00-6:00
Thurs-Fri. 10:00-9

CHILD CARE

HUGS AND KISSES CHILD CARE & LEARNING CENTER
104 N. Main St.
Plymouth
459-5830
Year round Pre-School • Ages 2 1/2-9 yrs • Full-time, Part-time, Drop-in, E.S.Y. Programs
• Licensed, Certified • Field Trips • Summer Camp 7 am - 6 pm.

DANCE INSTRUCTION

MASTERS OF DANCE ARTS
6034 Sheldon Rd. (at Ford)
Harvard Square
455-0720
Ballet • Tap • Jazz • Gymnastics • Pre-School • Hawaiian • Baton • Modeling • Singing • Drama

FIREPLACE SHOP

VILLAGE FIREPLACE
"The Alternate Energy Center"
6074 Sheldon Rd.
459-3120
• Complete home fireplace center • Zero clearance fireplace units • Inserts • Airtite wood stoves • Furnace add-ons • Complete line of accessories.

FIREWOOD

SUBURBAN FIREWOOD
46875 Newton, Canton
495-1311
FIREWOOD
Split-mixed hardwoods well seasoned. Jonsored's and Olympic Chain Saws. A complete repair service with a full line of accessories.

FLORIST

HEIDE'S FLOWERS
Ann Arbor Trail at Harvey
453-5140
Largest selection of fresh, dried & silk flowers. Also featuring Wicker, Stuffed Animals, Brass & Pottery. Daily Deliveries.

FURNITURE

LAUREL FURNITURE
Complete home furnishings. Large selection of baby furniture and clocks. Quality furniture moderately priced. Free delivery.
584 W. Ann Arbor Trail
Plymouth
453-4700

FURNITURE REFIN.

FURNITURE REJUVENATION UNLIMITED
Old Village - Plymouth
882 Holbrook 459-4930
Natural & Painted Finishes • Wood Repair • Woven Seats • Hand Stripping • Wicker Repair.

GARAGE BUILDERS

RAY R. STELLA, CONTRACTING INC.
747 S. Main Plymouth
459-7111
Each of our garages built to your particular need and home style.
• Attached or free standing • Free Estimates • Financing.

GROOMING & BOARD

TOWNE & COUNTRY KENNELS
47857 Cherry Hill Rd.
Canton
453-2790
• All breed grooming & boarding • Reasonable rates • Veterinarian Recommended
"Let us pamper your pet"

HALL FOR RENT

VFW 6695 PLYMOUTH
1426 S. Mill St.
Plymouth
455-8950
Wedding, Graduations, Anniversaries, Meetings, Fund Raising, UNDER NEW MANAGEMENT.

HEATING

PUCKETT CO.
412 Starkweather
Plymouth
453-0400
Air conditioning • Heating • Plumbing • Sewer cleaning • Visa • Master Charge • Night & Day Service • Licensed • All Areas.

HOME IMPROVEMENT

RAY R. STELLA, CONTRACTING INC.
747 S. Main • Plymouth
459-7111
Complete Remodeling Service
• Kitchen planning & Design • Additions • Family Rooms • Sun & Garden Rooms • Porches • Free Planning & Estimates • Full Financing

INSULATION

AIR TITE INSULATION
882 N. Holbrook
Plymouth
453-0250
Save on the cost of heating-cooling. Fast, professional installation "your comfort is our business."

INSURANCE

ALLSTATE INSURANCE
Lets Compare, Maybe I can save you some money
• Auto • Home • Life • Business
Call me & Compare
Ken Montay-453-7100
5924 Sheldon
Canton Mi. 48187

KITCHENS

ROSEDALE KITCHENS
459-2186
• Custom Designed Kitchens & Baths • Wood & Formica Cabinets • Vanities • Corian Tops • Counter top replacements • Free Design & Estimates.
Licensed Builders

LADIES FASHIONS

HELEN'S FACTORY OUTLET
425 Inkster Rd.
Garden City, Michigan
425-8600
Classic styles and up to date coordinated fashions in sizes 3 thru 46. Tues. thru Sat. 10-5:30 p.m. Thurs. 10-8:30. Closed Monday.

LAUNDRY

FOREST LAUNDRY AND CLEANERS
585 Forest, Ply. •
937 Ann Arbor Rd., Ply.
453-1880
• Full Service or Self Service • Flat Work beautifully finished • Self serve dry cleaners • Two locations to serve you.

LOCKSMITH

THE TOWN LOCKSMITH
1270 S. Main
Plymouth
455-5440
Locks repaired and installed. Keys made for residential • Commercial • Cars (American & Foreign) • Combinations Changed house, auto, safes.
• Locking Gas Caps

MATERNITY APPAREL

MATERNITY VOGUE
7353 Lilley Rd.
Kings Row Shopping Center
Canton, MI
459-0260
Fashion for the price conscious "mother to be." Great selection in all departments. Mastercharge & Visa.

MEAT MARKET

PORTER HOUSE MEAT MARKET
1058 S. Main
Plymouth
455-6770
Specializing In:
• Fresh USDA Choice Meat • Freezer Specials • Fresh Seafood
• Homemade Sausage • Deli
Plymouth's Newest & Finest Meat Market

MUSIC

ARNOLDT WILLIAMS MUSIC
5701 Canton Center Rd.
Canton, Michigan
453-6586
Pianos • Organs • Guitars • Electronic Keyboards • Microphones • Amplifiers • Sound Systems • Sheet music • Record Lamps • QRS Piano Rolls • Bench Pads

PLUMBING

JOHN J. CUMMING PLUMBING
1425 Goldsmith
Plymouth
453-4622
Kohler plumbing fixtures • Residential • Commercial • Repairs • Modernization • Rheem water heaters.

REAL ESTATE

REALTY WORLD
Wm. Decker, Inc.
670 S. Main St.
Plymouth
455-8400
"OUR WORLD REVOLVES AROUND YOU."

RESALE SHOP

HIDDEN TREASURERS
778 S. Main St.
Plymouth
459-9222
Good previously owned Furnishings • Childrens Toys, Needs • Sporting Goods • Lots More.
Monday-Saturday 10:00-8:00
Friday till 8:00

SEWER CLEANING

FAST EMERGENCY SERVICE
261-7688
Removing Tree Roots From Pipes • Clogged Drains • Flooded Basements • Floor Drains • Main Lines • All Repairs Residential • Commercial

SHOE REPAIR

PETE'S SHOE REPAIR & LEATHER
322 S. Main
Plymouth
453-7779
• Hand tooled belts • Wallets • Hand Bags • Moccasins • Etc.
Mon.-Sat. 9-6 pm (Under Del's Shoes)
"Old Shoes Repaired Better Than NEW"

SLIPCOVERS

CUSTOM GALLERY
1095 York
Plymouth
455-3074
Custom made slipcovers • Shop at home service • Also: Vertical Shades, Upholstering, Levelor Blinds, Woven Woods • Free estimates • VISA-M.C.

STAMP & COINS

PILGRIM STAMP and COINS
729 W. Ann Arbor Trail
Plymouth
459-5275
Top prices paid for old jewelry Gold & Silver coins, Type & Proof Coins, U.S. & Foreign Stamps.

TAXI

STAR CAB
453-2223
• 24 Hr. Service • Airport Service • Package Pick-up & Delivery.
Ride a Star its Better By Far
Serving Plymouth & surrounding areas.

WALLPAPER & PAINT

PEASE PAINT & WALLPAPER CO.
570 S. Main
Plymouth
453-5100
Wallpaper • Paint, Custom Mixing • Unfinished Furniture • Olympic Stains • Art Supplies • Window Shades • Complete Decorating needs.

Dear Santa

If you get chance, to come to my house, I would like a typewriter, a tape recorder and simon. Also I wish for the hostages in Iran to be freed.

SHERI FISHER
Canton

I have been a good boy I would like to have games, clothes, little crs, and a Raid and to be Happy with my family. Love,

ADAM EDDY
Canton

I would like the snowspeeder Gulpin Cupies. A pupy titantic model, Legoes.

TOM PIASTA
Plymouth

I want a race car set because I want to be a race car driver when I grow up.

JEFF DELBEKE
Plymouth

Hi Santa. How are you? I'm fine. I want 3 Barbie Dolls. Their names are Starr, Tracy and Shawn. I also want Mad. it is a borad game. It's fun.

BECKY NAPLES
Canton

For Christmas I would like, roller skates, a life saver sleeping bag, and a baby soft and sound doll, Love,

LAURIE KNAPP
Canton

P.S. My stocking will be in my room.

This year for Christmas I would like the Iranians to give us back the hostages. Also I would like peace all over the world. Thanks,

SCOTT TASKER
Canton

I want a pogostik and some stickers and wooden shoes and some dolla, Love,

SUSIE ATCHINSON
Plymouth

Please bring lots of toys for everyone. I don't care what is in my stocking but it is nice to have something. Thank you for all the lovely toys.

JENNIFER FREESE
Canton

I have been a good girl. For Christmas I want Strawberry shortcake, bell and snowman and koals bear and I want clothes. Love,

JENNIFER MULLEN
Plymouth

I am a good big boy. For Christmas I want a toy saw, a spaceship, a jeep, say hello to rudolf for me.

BILLY MULLEN
Plymouth

I wish that everyone will be happy on December 25 and that they will get what they wished for! Bless all the people in the world, love,

CHARLENE MULLEN
Plymouth

For Christmas I want pretty curls, a roll top desk, oh no 99, a t-shirt from the t-shirt shop, a stuffed animal, and some candy in my stocking, tape recorder. Love,

JENNY LAFER
Canton

I want talking Big Bird, alarm clock, a blue dog pajama dog.

SARAH LAFER
Canton

I would like a Corvette, if not I want a Mercedes, if you are all out of those, I would like a Porche or a Rolly Royce. By the way those are model car kits!

GREG WIACEK
Plymouth

I would like to have a barbie doll for Christmas. (Any kind.) I would also like that Dictionary, also if you can I want a doll of you!

TERESA COLETTA
Plymouth

I want a dolly that wets. I want a clock with seivester. I love you!

KRISTY MAUTHE
Plymouth

I'm twelve years old and I am in the 7th grade. I would like a pair of jeans and a shirt to match. Yours truly,

LAURA FLASKAMP
Canton

While your coming down my chimney please bring Raydeen and Dragon. Please bring my two sisters lots and lots of toys. This is my baby sister's first Christmas. Love,

MIKE GUTTENTAG
Canton

I want a toy truck and I want some toy cars and I love you. I want a picture of Rudolph Happy Christmas.

MICHAEL REAM
Canton

My name is Lybra. I am 4. I would like a dollhouse and a new truck for my brother. Thank you,

LYBRA LINDKE
Canton

I love you. Thank you for the presents last year. I would like the milleniymfalcon and tautau and more star wars people. Love,

JACK MICHAEL KLOSTERMAN
Canton

I hope you have a nice christmas and Christmas eve, I love you,

MATT COOK
Plymouth

I wish Christmas day was here I really want some shoulder pads, a mouthpiece, and a Michigan #1 shirt to play football in because I love the Wolverines and you.

MATT RONEY
Canton

I can ask for any present I want, but not always get it. To me the best present I can get is love. That's what a lot of people need.

brian soleau
Plymouth

I have been trying to be a good boy. Please bring me a fat wheels. My brother has been good too. Love,

RYAN TOWNSEND
Plymouth

All I want for Christmas this year is for everybody in Iraq & Iran to stop fighting and make world peace.

ERIK JENSEN
Plymouth

I hope everybody all over the world will have enough to eat this Christmas. I would like to share my food, toys and clothes with them.

JULIE JENSEN
Plymouth

I have been a very good girl. I would like these presents a Jewelry Box, a Soccer Ball, and some pierced earrings.

MAUREEN CARNEY
Plymouth

Please bring me some Starwars toys and something for my mom, dad, and sisters. Thank you. Love,

MICHAEL BRENNAN
Plymouth

I would like a baby newborn and a baby cry and dry. Thank you Santa.

HOLLY TRITTEN
Plymouth

I would like a race car set and a bike. Thank you Santa.

DARRIN TRITTEN
Plymouth

I would like a new bike my old bike was my sister's old bike. I would like Baby Feels So Real. I would also like Hello Kitty things. Love,

KATHRYN SHIRMOHAMMAD
Plymouth

I want a talking Mickey Mouse phone, Chips, Big Wheel cycle, Poppy Foggs on T.V., a new shelf for my anamils, a yittle cookwear, a yittle Christmas tree yights up!

RYAN REVOIR
Canton

This year for Christmas I'd like a few major and minor things. If it isn't a problem I'd like a phone, a Zanadu record, sound waves record, clothes, and peace. Thank you very much,

KRISTIN DEMERS
Canton

I have been a good girl. I help my mom and dad. Please bring me a doll for Christmas. Thank you. Love

KAREN GIFFIN
Plymouth

I would like a radio controlled trans am, a radio, watch, electronic baseball, and the 40 dollar gift certificate that the community crier is handing out.

PATRICK GIBBONS
Plymouth

I would like lots of things for Christmas. These are some of the things: a purse - brush & comb set - a wallet to match purse. Thank you Santa!

TRACY OSTROWSKI
Canton

I would like new records like Billy Joel and a calculator. Merry Christmas Santa.

JODY ENGEL
Plymouth

Would you please make me magic. Then I could help the hostages in Iran and make mean people nice. Thank you for the toys I have been getting. Love,

KWANZA NUNN
Canton

For Christmas I would like a Beauty Secret Barbie doll, train set, and Fashion Plates. Thank you,

KRISTIN KOWAL
Plymouth

How are you? If you can I would like an electric train set for Christmas and a super stunt dirt bike set.

AARON NIELSEN
Canton

I would like an Atari for Christmas and if you don't have Atari then I would like the little Space Invader Game. I hope I get one of them.

MARK WIACEK
Plymouth

I have been wanting an Atari for a long time and this Christmas I hope I get it. I also want a little Space Invaders Game.

MARK WIACEK
Plymouth

I want a doll and a toy boat. I have been a good girl. Thanks,

MEGAN ANDREWS
Plymouth

I have been a good boy, please bring me anything. Thanks,

DANIEL MAULDIN
Plymouth

I want a Boom Crain and a racer and a stunt bike. Thanks,

SEAN O'KEEFE
Plymouth

I help my mom and dad. Please bring me a doll and fill my stocking with surprises. Thanks.

ALLISON LAPOINTE
Plymouth

I am a good girl. I want a bicycle and a drum. Love,

ALISON DONNELLY
Plymouth

I have been a good boy. I help my mom and dad. Please bring me something, Santa. Thank you Santa,

JASON SWANAGAN
Plymouth

For Christmas Master Caster, Red moun-guse bike, strikers for number plate. Star Wars people, Y-wing fighter tools. Aluminun bat, football, Supper Star - guitar.

TODD SCHEBEL
Canton

I would like some crying dollies and baby sheets for their bed. Love,

EMILY STEWART
Canton

I would like to get my bike out of layaway so my brother can have my bike.

WADE HOLTON
Plymouth

I would like a baby doll and crayons, and a happy Christmas and my mom wants a happy Christmas too.

HEATHER COYLE
Plymouth

The thing I want most of all this Christmas is a play guitar. Also a cowboy hat, and a strawberry shortcake kitchen. That's all I can think of. Thank you

KRISTEN TIBURZI
Canton

For Christmas I would like some clothes. But most of all I'd like all the people especially the elderly to have a lovely Christmas.

LORI MORELLI
Plymouth

I want everyone to have a very nice Christmas. I want lots of presents, especially some Legos. I want you to be healthy. I love you,

COLLEEN BAKER
Plymouth

I want to open some presents. Will you bring me a Jenny doll. Say hello to Rudolph and everyone at the North Pole.

LISA BAKER
Plymouth

What I want for Christmas is the electronic game Blip, a new sleeping bag, Beauty Barbie's dog, baby cradle and Fresh and Fancy cosmetic kit.

AMY LEEDS
Plymouth

I want a monster mold, mighty-man and monster kit, animals books, the book of alligator, the movie, frog collection. Kiss record, Ace Freely on covor. Thank you.

MARK ZYLKA
Canton

HAIR TRENDS
BARBER & FAMILY HAIRSTYLING
BY APPOINTMENT & WALK-IN



\$2⁰⁰ off Haircuts & Perms
Special Prices on Children's Haircuts

Good Thru December 31
Pine Tree Plaza

Mon.-Fri. 10 am-8 pm
Saturday 9 am-3 pm

459-0404

39475 Joy Rd.
Canton Mi.

Holiday Special
\$4⁰⁰ Off

James Michener's New Novel

"The Covenant"

20 to 25% Off Selected Gift Books

Book Break

44720 Ford Rd.
New Towne Plaza - Canton
459-0430

Open Mon.-Sat. 10-9
Sun. 11-5:30

Poinsettias
from **\$3⁰⁰**

Christmas Centerpieces Wreaths
from **\$6⁰⁰**

Grave Blankets
from **\$15⁰⁰**

"FRESH DAILY FROM
OUR OWN GREENHOUSES"

Stein's FLOWER SHOP
AND GREENHOUSES INC.

397-0800
42158 Michigan Ave
Canton



Holiday gifts of Lenox China...
because you care.

Lenox China Gifts are created by skilled artisans to accent the most gracious homes in America. Many of these versatile and useful ivory-toned china gifts are trimmed in 24-Karat gold or precious platinum. Exquisite. And always in perfect taste.

This Holiday Season... be sure your gift is Lenox.

A. Lido Salt & Pepper Mill Set
8" tall, \$85.00

C. Symphony Centerpiece
10½" long, \$40.00

B. Woodland Vase
8" tall, \$25.00

D. Dove Dish
8" long, \$19.00

Exclusively in Plymouth at the store that
brings you that Affordable Touch of Class
Quality is remembered long after price is forgotten
When you shop at the...

YANKEE PEDDLER

44461 Ann Arbor Rd. (at Sheldon) 459-9690
Hours Mon.-Sat. 9:30-9:00 Sun. 12:00-5:00

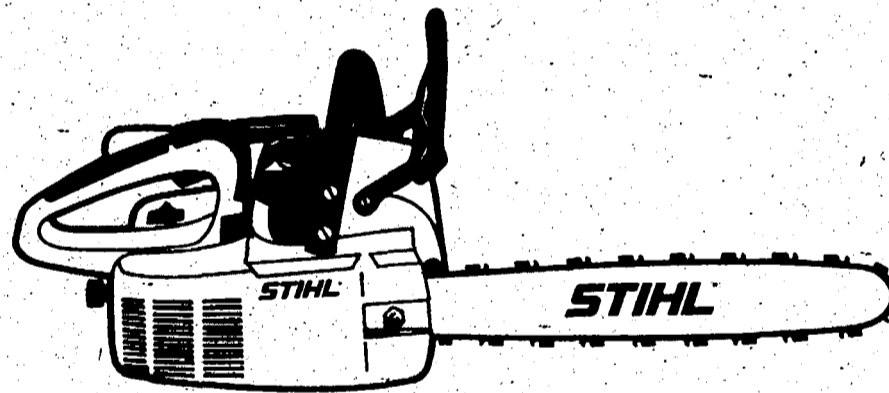

**A LITTLE STIHL®
GOES A LONG WAY.**

Introducing the Stihl 009. It's one of the smallest saws we make, but like our other models, it's big on power and performance.

The 009 has automatic oiling, protective hand guard, a muffler shield and a specially designed rear handle for better balance and operator comfort.

It's perfect for all kinds of cutting jobs around the yard. And the 009 can even take down a 24" tree.

The 009 is a great homeowner value. And since it's a Stihl, you know it will be around for a long time to come.

\$149.⁹⁵



Commercial Lawnmower Incorporated

"commercial and residential
lawncare equipment"

We Service what we Sell

(313) 525-0980

STIHL®

The World's Largest Selling Chain Saw.

34955 PLYMOUTH RD.
LIVONIA, MICHIGAN 48150

Plus

Dear Santa

I would like a vest, a Hello kitty stuffed animal, a snoopy pencil case, a soccer ball, a Hello kitty memo box, a kitty tote bag, a Crayola Caddy set. Love,

MISSY SMITH
Plymouth

I want some clothes. I wear a size 7 slim in jeans and a 7 or 8 in tops and a baby soft sounds.

BETHANY VERESH
Plymouth

I want to own Radio Shack (Wonderland)
DAVE CRADDOCK
Plymouth

I will come to the store to see you real soon. Love,

MELISSA WALTON
Canton

I would like a doll and 2x. I have been a good girl.

NICOLE SHANKIE
Canton

I would like a pair of tennis shoes size ten, two pairs of pants size eighteen, two pairs of shirts size eighteen, and erector set, color cube, crayons.

ERIK LOSSE
Plymouth

What would I would like for Christmas is a Donny and Marie microphone, an organ, a balance beam, uneven bars, Karen and her stroller, tons of stickers and a size 3 B toe shoes. Love,

LANA STAFIEJ
Canton

I want a Strawberry Shortcake and a new doll and a new bike and a new book and a new radio and a new top and a new record and a new papit player and a new recod.

RENEE LIVERNOIS
Canton

I am ten years old. I would like: Holly Hobbie Oven; Baby-That-A-Way; Snoopy Soft House; Kitchen Set; Dolly Pop Town; Huckleberry Pie, the big kind. I hope you have a Merry Christmas. Love,

ERIN V. LOSSE
Plymouth

I wish I could have a Electronic football game or a car racing set. I also wish to have a terrific Christmas. Bye,

CAROLYN ADAMS
Plymouth

I would like Team America, a police car, Zap Zap Race Track, a helicopter, and that talking thing. And please bring Katey a dolly and Pop-Up Pinball -- because I broke ours.

ADAM GILLES
Plymouth

I would like an AM-FM Radio. I love music and I don't have one. I would be really happy if I won because I have never won anything. Have a nice Xmas.

PAUL JURCZYSZYN
Canton

If you can, I would like the Strawberry Shortcake Dolls, a sewing machine and some; clothes. Please help everyone to have a Merry Christmas. Thank you very much. Love,

HEATHER PAUL
Plymouth

I know you can't promise me this but please try! My wish for Christmas would be peace in the world, so we the children of the world can go to bed at night and not worry about a tomorrow.

MISSY DUCZYNSKI
Plymouth

Will you please send me the Malahian falcon for Christmas and Star Wars people to. I am going to send you a card for you Santa have a Happy Christmas.

DAHYL
Canton

I would like to have the wing fighter, Star Wars people and some games. Please leave some book, too. Thank you,

PATRICK LANCASTER
Plymouth

I hope you thought I was a very good boy. I would like to have a Star Wars Snow-speeder. I really want it.

CHRIS WILLIAMS
Canton

I would like you to bring me a baby doll and the Strawberry Shortcake world. I've been extra good this year. Fly Safely! Thank you,

AMBER LANCASTER
Plymouth

I want a race track with cars, Pom Poms, Gold, Blue, Chinese jumpropes, a watch, snoopy wallet.

MELISSA VERNON
Plymouth

3/4 Size Student Guitar
\$24⁹⁵



Regency
4 Channel Police Scanner

\$69⁹⁵

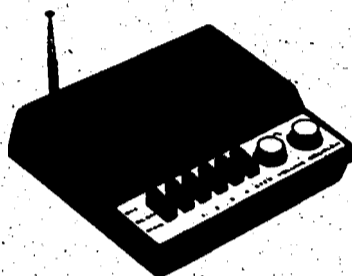

- Records & Tapes
- Guitars
- Car Stereo
- Sheet Music
- Police Scanners
- Tape Recorders

Many Other Bargain Gift Ideas!



9:30 am-8 pm Daily
11 am-4 pm Sunday

338 Main
Downtown Belleville
Phone: 697-9222

1 Mile S. of I-94
on Belleville Rd.
(Main Street)

mulhollands

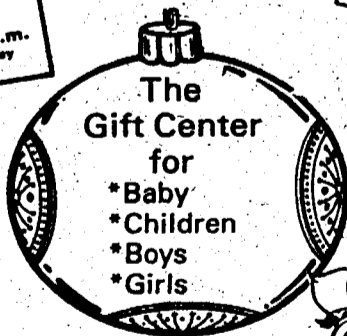

Ready for Christmas?
WE ARE!

Have a one-stop Holiday shopping spree and wrap up your Christmas with our merry savings! We've been busy as elves stocking up on all the best clothing gifts in town... We feature all Nationally known Brand Merchandise.

mulholland's
the Family Clothing Store

Christmas Gift Certificates Available
Visit our Dry Goods, Yard Goods and Linen Departments
At Metro Place Mall
Wayne • 721-8920
Since 1919

WIN
One of 5 \$100 or
One of 10 \$50 Shopping Sprees
During Wayne's Old Fashioned Christmas Celebration... Details & Entry Blanks available here.

mulhollands



Merry Christmas

**Personalized T-Shirt
with Transfers & Lettering**

SHIRT WORKS
Next to Penn Theatre
770 Penniman Ave.
459-3344

459-3344

the willow tree

298 S. Main
Plymouth



**will be open Evenings and
Sunday for your convenience**

the usual . . .
. . . and the unusual

izod jogging suits patchwork terry towels
christian dior dress shirts alligator socks
liberty of london ties chicago saving products
isotoner gloves perrier bottle opener
versatile tweed sportcoats solar powered toys

Pre Christmas Savings
Velour Shirts \$24.98 & \$29.98
All Fall Outerwear 20% off
Corduroy Slacks 20% off

fred hill's



CLOTHING COMPANY

**FIRE RESISTANT
SECURITY CHESTS**

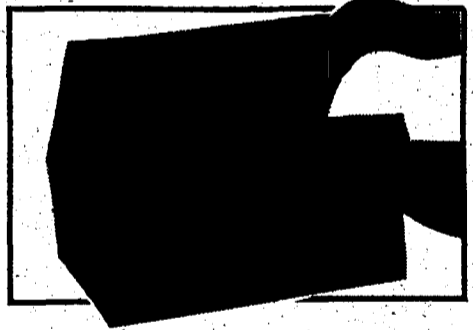

- Double Wall Insulated
- Includes Keylock and Valuable Papers Envelopes
- Ideal For:
 - Insurance Papers
 - Certificates
 - Documents

Available In Three Sizes-Black or Beige

- No. 300 - \$17.50
- No. 400 - \$21.50
- No. 500 - \$30.00

PERFECT FOR GIFT GIVING

Plymouth Office Supply
840 W. Ann Arbor Trail
453-3590
Across from the Mayflower Hotel



**Children Love to Give Special Gifts
to their Own Special People**

Hidden Treasures has a bountiful selection of lovely surprises for Moms & Dads & Grandmas & Everybody. AND...we are happy to help them shop.

*Our Small Prices fit Small Budgets
and make*

BIG HAPPY CHRISTMAS SECRETS



HIDDEN TREASURES

RESALE SHOP
728 S. Main St.
Plymouth • 459-9222

Still looking for that special gift
for the men in your life...



Wild Wings Gallery
has many to choose from.

Over 200 pieces of framed
Wild Life Art.
Many related gift items

WILD WINGS GALLERY
975 W. Ann Arbor Trail

(Downtown) Plymouth 455-3400
Holiday Hours Until Dec. 23rd.
Daily 10-9 Sat. 10-6 Sun. 12-5

Major
Credit Card
Accepted



CHRISTMAS SPECIAL
MEN'S
PENDLETON
SLACKS
SALE **30% OFF**

SELECTED ITEMS-120 ITEMS
SALE LASTS UNTIL STOCK DEPLETED

NAWROT, INC.

PENDLETON SHOPS

Mon-Fri. 9:30-9:00
Sat: 9:30-6
Sun. Noon-5

Forest Place, Plymouth

455-0210

For the Holiday give the
most precious gift of all
...Good Vision

Gift Certificates are Available
for Family and Friends

**Mayflower
Optical Shoppe** Ltd.

817 West Ann Arbor Trail
Plymouth, Michigan 48170
"In the Mayflower Hotel"



Plymouth Book World
for that extra
Special Gift

"Wind in the
Willows"
Newly Illustrated

"Masquerade"
for an adventure in
Art & Imagination

2 Forest Place Mall
455-8787

844 Penniman
455-6660

Candy is a Gift for
the Whole Family...
our homemade candies can be enjoyed
by all...

Choc-Kommittee Fine Candies

Mon-Thurs. 9:30-8 pm
Friday 9:30-9 pm
Saturday 9:30-6 pm

896 W. ANN ARBOR TRAIL
PLYMOUTH, MICHIGAN
453-0480

Pre Holiday Christmas Sale

20% OFF all non-sale merchandise
Sat., Dec. 20 through
Christmas

The Expression of
Quiet Distinction
in
Designer Lingerie
Perfumes
Accessories



Enchanté

American Tourister
"De Luxe"

A Gift for the Individual who wants the Very Best

Style 5503-Ultra Slim Attache
Reg. \$75.00-Now \$49.95

Style 5518-Cosmopolitan Attache
Reg. \$78.00-Now \$56.95

Plymouth Office Supply

840 W. Ann Arbor Tr.
453-3590
Downtown Plymouth

Still looking for that
special gift?
New things arriving daily

**Minerva's
Dunning's**

Merry Christmas and
Happy New Year to All

Free Parking
in Rear
500 Forest
453-0080

Hours:
Mon.-Fri. 9-9
Sat. 9-8
Sun. 12-5

Dear Santa

Whats going down now listen to me please. I want some clothes, games, anything you think I deserve. Thank you, see ya man.

JANET ARMSTRONG
Canton

I would like some shoe roller skates for a roller rink because I like tos kate. I would like some sweaters and clothes.

DEBBIE SWEENEY
Plymouth

I would like the hostages to come from Iran, no more wars, and peace on earth, Merry Christmas Santa, truly yours

ANGIE BELDEN
Plymouth

I would like lots of Lego sets, some Dungeons & Dragons stuff and a tape recorder. If you would likt to know more, ask my mom. Love,

CHRIS SANDS
Canton

For Christmas, I would like the hostages set free from Iran, and the Iran-Iraq war ended. If this is too much, I'd like some dollhouse furntiure. Sincerely,

KAREN SANDS
Canton

I would like to have for Christmas are, a ten-speed bike, cross-country skiis, clothes, and snow. Thanks,

KAREN J. OCHMAN
Canton

For Christmas I would like love and peace int he world, no bad people, food, money, and clothing for the poor, and help the sick so they don't suffer.

KELLEY KARASSY
Plymouth

The thing I would like best for Christmas is love & peace throughout the world. Merry Christmas and a Happy New Year! Love,

JEFF J. KARASSY
Plymouth

I will wait up for you all night and we can have cookies and milk together. Please don't forget my presents.

AARON FRANK
Plymouth

For Christmas I would like my whole family to be safe and happy and for everyone to have a very joyous Christmas.

BETH COKER
Plymouth

I have been a good girl. This is what I would like for Christmas. Roller skates with stoppers, books and Barbie things. Have a Merry Christmas. Love,

DANETTE DUKE
Plymouth

Mom and dad, my 2 brothers and myself Amanda are waiting for you. There will be cookies and milk on the table for you. Merry Christmas.

AMANDA RICE
Canton

I would like a lot of toys. I have been waiting for you. Please give the poor kids a lot of toys, too. Love,

STACIA NORQUIST
Canton

I would like a lot of things. Please let the Iran hostages come home for Christmas to be with family's. And the people who are sick try to make them happy. Merry Christmas Santa.

KRISTAN NORQUIST
Canton

I want a gold hart and a ring and lip gloss. Thank you,

AMY BROWN
Canton

I would forum ski, I love you Santa,

LANI BROWN
Canton

I just hope everybody's happy and thankful. And that the poor have warm enough clothing and enough food. Sincerely,

LAURA HENRIE
Plymouth

I would like for Cristmas: A Stomper 4x4, Stratego, and roller skates. Love,

STEVE HENRIC
Plymouth

For Christmas I want Sueasy. Brownie watch purse Doll Dog totebag, ring and bracelet set training, shoes size 2, blue and white, Meg0 2xL, game Family Feud, Mad game.

CONNIE PRINCE
Canton

For Christmas I would like a race track, a remote control vette, a star wars ton-ton, a compond bow, a slevles jacket, and a fishing pole.

BOBBY PRINCE
Canton

Christmas isn't presents and all it's other things to like getting together with other people having fun and celebrating Christ's birth.

DONN OTT
Canton

255 Computer Command Corvette, set of Captain America, car intruder, Godzilla wrist each.

DANNY PRINCE
Canton

I want walkie talkies, 2 pair.

JUDI ANN PRINCE
Canton

I would like a Tiger Electronic Head to Head football game, shutes away, 255 computer comand vette or the big trak. And I really would like a GTX racing bike.

ALAN PRINCE

Lite Brite, Doll, Music Box.

KAREN RANDINITIS
Plymouth

Doll and Book.

JOANNE RANDINITIS
Plymouth

I would like to have a racetrack, football and other toys. I have been a good boy all year. Love,

RYAN MILLER
Canton

For Christmas I would like a hoarse, a belt, a game (Merlin) and some loves baby-soft (powder, cologne, milk bath, bubble bath or after bath splash.)

JENNIFER BARNES
Plymouth

I want a bike, stereo, smaller home's and gardens, doll house, pant's & shirt's, holy hobbie oven; new shoes, TV, make up set, with oven. boot's, coat, doll chest, paints.

DAWN HERNANDEL
Canton

For Christmas I would like to see Peace on Earth, Goodwill towards men and for all people to have a Merry Christmas. Santa, for myself, I would like a Danny-O-Day doll.

NICOLE BURCHART
Plymouth



Dave's Carpet Service

459-3090

WE HAVE MOVED

LOOK FOR US IN OUR NEW LOCATION

"YOUR HOME"

Yes, we now offer
AT HOME SERVICE to
see our beautiful selection
of Carpet samples or
Vinyl Floor. Call us for an
appointment and we will
personally bring to **YOU**
the Largest Selection **YOU**
have ever seen. We have
closed our retail store
location to better serve
each customer at their
convenience. Our hours
now will be **YOUR** hours.
No need to leave the
comfort of your home.
Call soon for any Carpet
Services you may need.

Now Offering

25% off

On all Cleaning
until Christmas

Furniture and Carpets

Call

459-3090

SERVICE IS OUR BUSINESS

CHRISTMAS IN

Old Village



For Christmas Shopping
Old Village Open
Sundays, Noon-5 pm
thru Christmas

Lorraines Dolls
Hospital and Toys

Little People Adoption Center

—AS SEEN ON T.V.—
"Real People"

Best selection of
Dolls in town

459-3410 • 464-2010
615 N. Mill (Corner of Spring)

The Holidays ahead
make us more aware
of how Special
We Appear . . .

Let our experts give you their best
P.S. Gift Certificates Available

HOUSE OF GLAMOUR SALON
is going **Great Shape** for you
630 Starkweather 453-5254



IN THE OLD VILLAGE
IT'S
Bill's Market

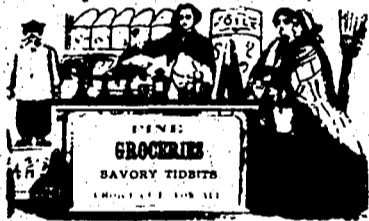

584 Starkweather
Plymouth
453-5040

We have delicious sandwiches to carry out every day. We have Beer & Wine to take out. We have Groceries-Meats Party Snacks-Deli-catessen.

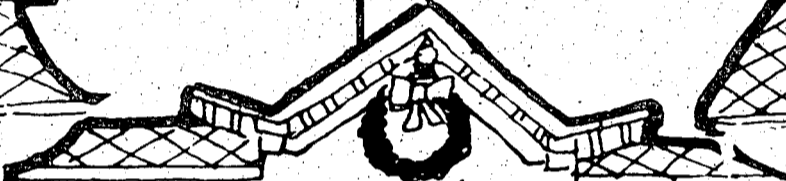

Handicraft House of
USEFUL UNIQUES

557 Mill, Plymouth, Mi. 48170
(313) 459-6767

LOW LOW PRICES!

"Everything" imaginable
handmade for You - Your
Home - Your Family & Gifts!
How about Custom items: Pens,
Inks of Houses - Family - Stationery
or Cards, Wood Names! Classes too.

**FREE
GIFT WITH \$10 PURCHASE**

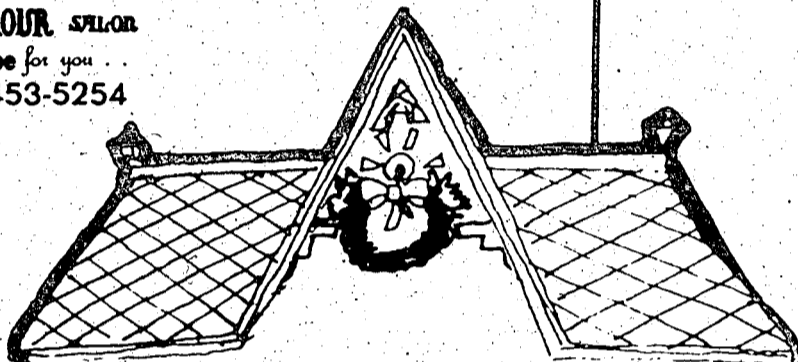

Charm of the Past
creates the Beauty
of our homes today.

ANTIQUES

Shop Leisurely at the
Five Antique Shops
located on
Liberty Street
Between Starkweather
and Mill
453-0440 in Old Village

Having the Gang over for the Holidays?



Alaskan King Crablegs
\$5.55 per lb.
Min. 5 lb. Order
20 lb. Case \$106.00

455-2630

Cocktail Shrimp Large
16/20 per lb.
Ready to Eat
\$10.00 per lb.
Shelled • Deveined
& Cooked
Weighed before
Cleaned

Hot Clam Chowder Every Weekend

578 Starkweather
(Behind Bill's Market)

Free
Cocktail Sauce
with 3 lb. Order

Special Purchase
of
New Books

50% OFF

or more

We will have Gift Certificates for Christmas

VILLAGE PAPERBACK EXCHANGE

Hours: Daily 10-5, Sunday 12-5
Friday til 8 pm

Old Village
819 N. Mill
Plymouth
459-8560

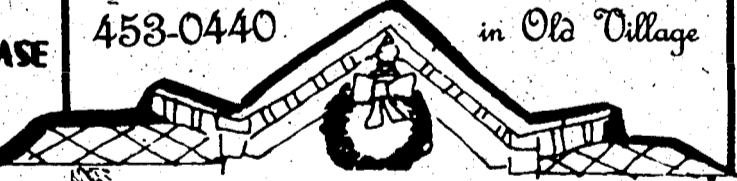
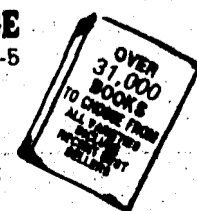

BUSY BEE CRAFTS
845 N. Mill

new location (in Old Village)
455-8560

For That Crafty Person
a Gift Certificate is
Available

Our January Newsletter
will be out soon
Plan ahead for January Classes
Now

- Some of the new ones:
- Miniature Wicker Furniture
 - Padded Picture Frames

CHRISTMAS IN

Old Village

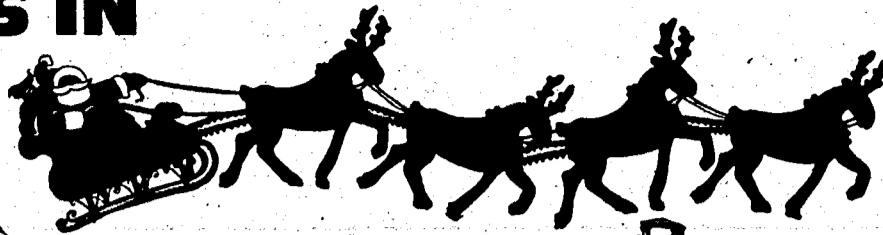

For Christmas Shopping
Old Village Open
Sundays, Noon-5 pm
thru Christmas

"Hair is Our Care"



Give a Gift
Certificate for Xmas



950 Starkweather
453-8020

Christmas Is Here



Dakin
&
Russ
Stuffed Animals.

- Smurfs •
- Woolfits •
- Pre-Historic Pets
- Norman Rockwell Collectables

AR Artesania Rinconada

696 N. Mill St.
Plymouth

459-0310

the potters wheel Gallery

Handcrafted gifts with
Personality that grow
in Value



- *Pottery
- *Watercolor
- *Weavings
- *Miniatures
- *Blown Glass

689 N. Mill
459-9890

NEW GAL IN TOWN

620 Starkweather (in Old Village)
Plymouth, Mich 48170
459-5575

15% Off thru Christmas

Has all the trimmings necessary
for a classic holiday look for you-
everything you need to get in the
Christmas spirit.
See our many gift items, too.

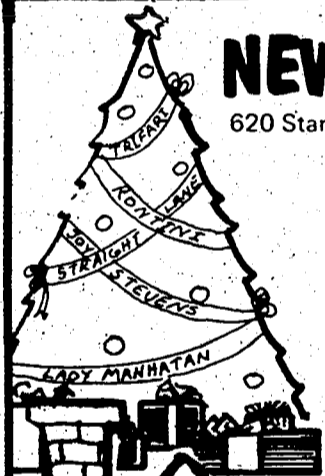

'Happy Holidays!'

We Know Our Books



710 N. Mill
Old Village
459-5444

ATTENTION.
FIREPLACE
OWNERS!

Christmas Specials

Save

Up to 20% on Some Models
Polar Stoves • Add on Furnace
Fireplace Inserts • Pipes • Coal Brushes

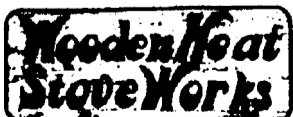

744 Starkweather
459-0920

BIG J'S TV

- ★ Save \$\$ on Carry-In
- ★ Expert Service Most Makes
- ★ Check while You Wait

384 Starkweather
453-6480

All Carpet Cleaners
are not alike...

Don't find out the
hard way,
have them cleaned by

**Plymouth
Carpet
Service**

With our new steam extractor

1175 Starkweather 453-7450.

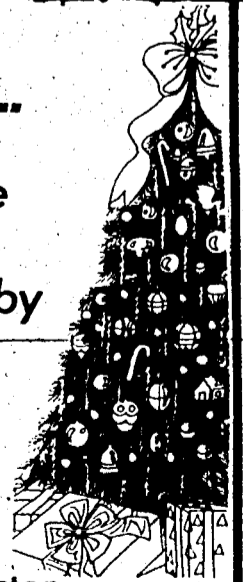

Something for Everyone



CANDLE TINS \$7.50
Bath Crystal Tins \$7.50
"Clean Up Your Game" Soaps \$4.25



Body Liquers \$8.50
Body Paints \$7.50



Christmas
Finger Tips \$2.00 to \$5.00
Christmas Soap \$1.50 ea.
Christmas Pomanders
\$7.50 & \$10.00

Back Brush-\$14.00
Backscrubber-\$12.50

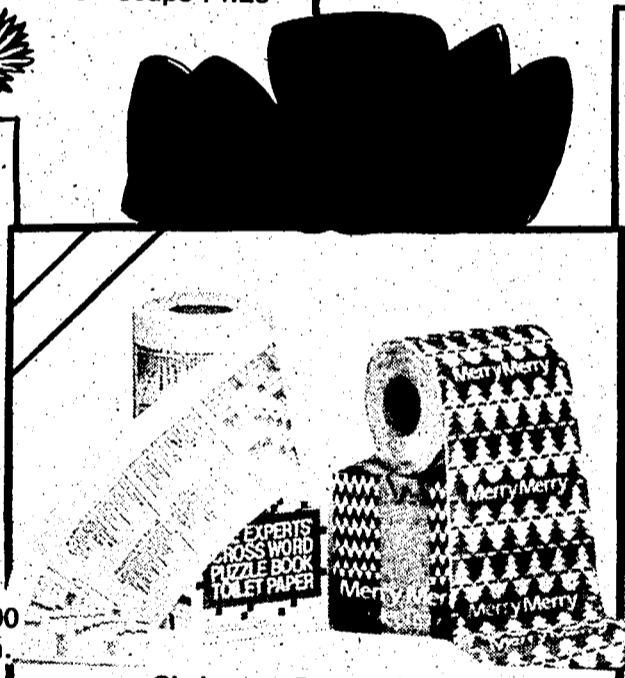

Christmas Roll T.P. \$2.95



Bath Pillows
\$5.00 to \$7.50

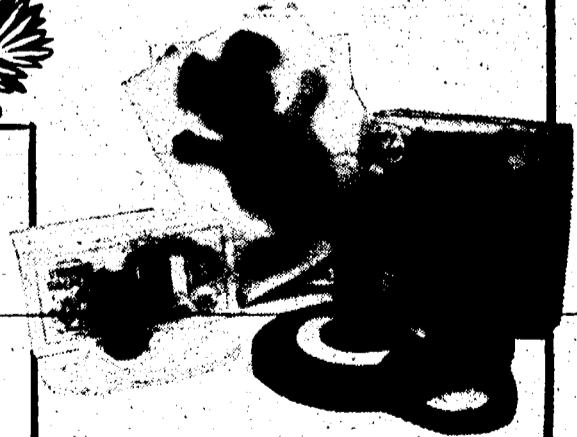

Kids "Things"-\$2.95-\$5.00



One of Michigan's Largest & Most
complete Bath Shops

Long's
Fancy Bath Boutique
DIVISION OF LONG'S STORES
10 E. Main Street • Northville • 49073

Mon., Tues., Wed., Thurs. 9-5:30
Fri. 9-9 Sat. 9-5
Sun. 12-5 Starting Dec. 7
thru 21

community deaths



Holstein

Rose M. Holstein, 86, of Plymouth, died Dec. 7. Funeral services were held Dec. 10 at Schrader Funeral Home with The Rev. Philip Rodgers Magee officiating. Burial was at Riverside Cemetery.

She is survived by her daughter, Saxie Heft of Livonia; son, Louis of Standish; sister, Trudi Livingood of Zephyr Hills, Fla.; and one granddaughter, Karen Heft.

Mrs. Holstein was the granddaughter of George Starkweather, one of the founding fathers of Plymouth, and the sister of Karl Starkweather, well known as a local historian.

Graduating from Plymouth High in 1913, Mrs. Holstein attended Thomas Normal College in Cincinnati, Ohio and graduated as a dietician. She resided for 55 years on Rose Street in Plymouth, which was named for her. She was also a member of the First United Presbyterian Church for more than 65 years.

Jason

Stella Jason, 99, of Plymouth, died Dec. 13 at home. Funeral services were held Dec. 15 at Lambert Funeral Home with The Rev. Margey Schleicher officiating. Burial was at Forestlawn Cemetery.

She is survived by her daughter, Mary Tepper of Plymouth; sons, Ray of Plymouth, Carl of Palm Harbor, Fla., Ervin of Port Richie, Fla.; eight grandchildren; nine great-grandchildren and one great-great-grandchild.

Mrs. Jason was a member of the Newburgh United Methodist Church, Polish National Alliance No. 418 and Polish National Society No. 2278.

Phillips

Florence Charlton Phillips, 90, of Drayton Plains, died Dec. 7 in Marlboro, Mass. Funeral services were held Dec. 10 at Schrader Funeral Home with The Rev. Douglas Gallagher officiating. Burial was at Riverside Cemetery.

She is survived by her son, Jack of Iron Mountain; daughters, Evelyn Staehle of Elmhurst, Ill., Grace McNamara of Drayton Plains; sister, Mary Durant of Gault, Ontario, Canada; 12 grandchildren and 13 great-grandchildren.

Mrs. Phillips was a resident of Plymouth from 1921 to 1949.

Skorina

Elizabeth Skorina, 54, of Canton, died Dec. 8. Funeral services were held Dec. 12 at Schrader Funeral Home with The Rev. Kenneth E. Zielke officiating.

She is survived by her husband, George; mother, Natalie Bondaruk of Canada; daughters, Faye Domino, Margaret Domino; Mary Malpass; and brother, Ernest Gerasimoff.

Shirley

Herman J. Shirley, 94, of Plymouth, died Dec. 10 at St. Joseph Mercy Hospital. Funeral services were held Dec. 12 at Lambert Funeral Home with The Rev. Frederick C. Vosburg officiating. Burial was at Grandlaw Cemetery in Detroit.

He is survived by his daughter, Joyce Roebuck of Plymouth; brothers, Albert of Pinckney and Ival of Blissfield; and three grandchildren.

A former steam fitter retired from Detroit Edison, Mr. Shirley was a member of the First United Methodist Church of Plymouth.



May you enjoy the deeply enriching experience of the spiritual inspiration of Christmas and its message of Peace & Good Will.

The Schrader family,
Funeral Directors in
Plymouth for 76
years.

SCHRADER

FUNERAL HOME INC.

280 SOUTH MAIN STREET, PLYMOUTH, MI 48133
Edwin A. Schrader Jr., Edwin A. Schrader

A 25% Savings You Can't Afford To Miss!



Everybody's talking about the fantastic savings on our 10K & 18 K gold fashion ring collection. With exciting styles to choose from, you can accent your fashion fancies with Diamonds, Rubies, Emeralds, Sapphires & Pearls. It's just one of those sales you can't afford to miss!



O. & D. Bush Jewelers

481 Ann Arbor Trail, Plymouth
455-3030

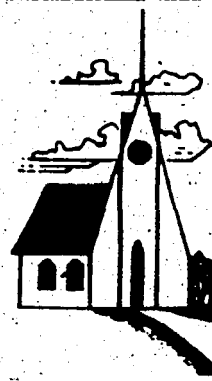

Come Worship With Us

Epiphany Lutheran Church

41390 Five Mile Rd.
¾ mile west of Haggerty
420-0877
Pastor Fred Prezioso, 420-0568

Sunday Worship 10:30 a.m.
Nursery Provided

Plymouth Church of the Nazarene

41550 E. Ann Arbor Tr.
463-1525
Carl R. Allen, Pastor

Sunday School 9:45 a.m.
Sunday Services 11 a.m. & 6 p.m.
Midweek Service (Wed.) 7 p.m.

Lutheran Church of the Risen Christ

Missouri Synod
46250 W. Ann Arbor Rd.
1 Mile West of Sheldon
453-5252
Rev. Kenneth E. Zielke

Sunday Services 8:30 and 11:00
Sunday School & Bible Study 9:45 am

First United Methodist Church

45201 N. Territorial
463-5280
John N. Grenfell, Jr.
Frank W. Lyman, Jr.
Fredrick C. Vosburg

9:30 & 11:00 am Services
and Church School

Your Guide to Local Churches

Tri City Assembly of God

2100 Hannan Rd.
N. of Michigan Ave.
721-8832
Rev. E. W. Raimer, Pastor
Sunday School 9:45 a.m.
Morning Worship Service 11 a.m.
Evangelistic Service 7 p.m.
Ministry to the Deaf

First Baptist Church

45000 N. Territorial Rd.
Plymouth 455-2300
Pastors: Dr. William Stahl
Rev. John Elliott
Sunday Services:
Sunday School 9:40 a.m.
Morning Worship 11 a.m.
Evening Service 6:30 p.m.
Wednesday: Family Night 7:00 p.m.

People's Church of Canton

Reformed Church in America
Worshipping at Plymouth
Canton High School
8415 Canton Center Rd.
Morning Worship 10 a.m.
Adult Bible Class at 11:30
Sunday School 11:30
Nursery Available
Rev. Harvey Heneveld Pastor
961-0499

Sports

Jackson insurmountable; Rocks bow out in semis

BY KEN VOYLES

Hard work and determination propelled the Salem High girls' basketball team into the Class A semi-finals Friday night in Lansing.

But the team expended so much energy running the ball down the court that it couldn't muster the points to defeat Jackson High school. Jackson won the game, 51-33.

The Rocks were outscored, 11-1, by the end of the first quarter. Although a solid second quarter kept the game within their reach, the Rocks used too much energy moving the ball; they couldn't make a strong run in the final two quarters. The first-quarter

margin proved insurmountable.

"Their pressure defense was the game," said Salem Coach Bob Blohm. "The pressure wears you out and takes you out of your game plan."

"When you get behind against good teams it takes a lot of energy. You fatigue yourself getting back in the game," he continued.

Jackson went into a full court defense from the very beginning of the first quarter and didn't let up until late in the fourth quarter.

Eileen Moore went to the free throw line with 2:02 remaining in the first quarter

Cont. on pg. 53



SALEM CO.—CAPTAIN Eileen Moore is seen from above as she works the ball against three Jackson defenders. (Crier photo by Robert Cameron)



SALEM GUARD Carol Ross moves up the court guarded by Margaret McDermott early in the semifinals in Lansing. (Crier photo by Robert Cameron)



JAN MACKENZIE (24) gets bumped out by an aggressive Jackson girl under the boards during the Class A semifinal game at Lansing. (Crier photo by Robert Cameron)

Jackson Citizen Patriot invites you to

Come

VISIT JACKSON, MICHIGAN

Home of the 1980

CLASS A GIRLS' BASKETBALL STATE FINALISTS



Front Row L-R—Tracy Turner, Tracy Caspar, Denise Pierce, Regina Pierce, C. C. McDermott, Trisha Overall.
Back Row L-R—Coach Andy Sheridan, Paulette Prather, Sonya Hughes, Margaret McDermott, Yvonne Chalfant, Ellen McDermott, Tracy Pierce, Marcel Cole.

Jackson is a community on the move with many interesting things to do. Here are just two of the many attractions you'll find in the Jackson area.

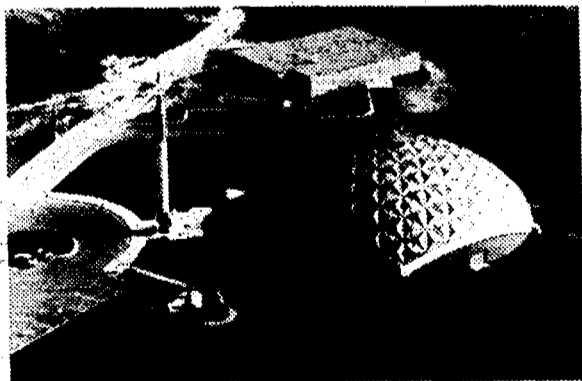

For fun and adventure for the whole family, visit the Michigan Space Center. It is located at 2111 Emmons Road, 6 miles south of Jackson on the campus of Jackson Community College. See exhibits, displays, movies, actual Apollo 9 Command Module, Mercury and Gemini full-size trainers, satellites, moon rock, spacesuits, space food and the 85-foot Mercury Redstone Rocket. Open all year round: Monday-Friday 8 a.m. to 5 p.m. Saturday and Sunday 11 a.m. to 5 p.m.



In 1963, a community-wide effort established the Ella Sharp Museum "Hillside" as a Victorian country home. Since that time a 1-room 1875 school house, a log cabin from the 1830's, the Peter F. Hurst Planetarium, a country store and restored barns for use as exhibit areas and classrooms have all been added to the complex. The Ella Sharp Museum provides authentic examples in the areas of history, natural history and art. The museum is open Tues. thru Fri. 10 a.m. to 5 p.m., Sat. and Sun. 1:30-5. Closed Monday's & Holidays and entire month of January.

The Jackson Citizen Patriot salutes the fine Plymouth Salem girls' basketball team, for a valiant run at the championship. We further salute the sporting publisher of the award-winning Community Crier, "Shirtless" Ed Wendover, who bet on his team and lost this page advertisement.

1/3 OFF
KING MOUNTAIN
1/2 OFF
all Wrapping Paper
and Printed Novelty Ribbons



See Us for

Trees • Wreaths • Ribbons & Bows
 Garlands • Tree Skirts • Ornaments
 Candles • Snow Flocking • Trees
 Poinsettias • Mums

PLYMOUTH NURSERY

9900 ANN ARBOR-PLYMOUTH RD.
 PLYMOUTH, MI. 48170
313-453-5500

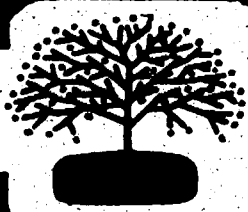

Win over Trenton sends Salem onto Lansing

Salem's girls' basketball squad reached the Class A semi-finals in Lansing with a win over Suburban Eight League foe Trenton in the quarter-finals last Wednesday, 32-30.

It was the third meeting between the schools this fall. The Rocks got a lay-up from Eileen Moore with 50 seconds left in the game to give them the needed points to beat the Tractors.

The Rocks stumbled through a tough first quarter and didn't score a point until the 55-second mark when Pam McBride hit one free throw. Trenton was on top 11-1 then.

In the remaining 55 seconds of the quarter, the Rocks added three more points to make the score 11-4.

Cheryl Sobkow started the Rocks second quarter with a basket and the team picked up three more before the end of quarter. Trenton scored six points in the period and Salem had edged closer, 17-12, by the halftime.

Moore, Jacque Merrifield and Carol Ross scored baskets for Salem in the third quarter and Jan Mackenzie added two, while Trenton was held to three points in the period. That tied it up at 22-22 and set the stage for the final quarter of action.

"The middle two quarters were mighty

good efforts for us," said Salem Coach Bob Blohm. "Our point of emphasis at the half was to start our offense off quicker in the second half, to get off more shots and to step up our guard pressure on defense.

"Our guards stepping up their pressure was one of the major keys against Trenton," he continued. "In the first half we had a hard time getting inside on Kim Nash then we found that Sobkow could work in front of her fairly well and that helped."

Salem went ahead for good in the fourth quarter when Moore hit a basket to make the score 25-24.

In the final two minutes, Ross hit one free throw, then Sobkow made two before Moore's basket.

Trenton was not done, though, with the score 32-28. Anne Preston hit a basket with 19 seconds left to close the score 32-30.

With nine seconds left, Merrifield missed a shot and Trenton got the rebound and came up the court. Tammy Cunningham's last second shot rolled off the rim.

Sue Mattice paced Trenton's scoring with eight points, while Nash had six.

Mackenzie scored eight for Salem. Sobkow had seven, while Moore and Merrifield had six each.

Chief grapplers 7th at Glenn

BY CRAIG BRASS

The Canton Chiefs grappled to a seventh-place finish in the Westland John Glenn Invitational Saturday, their best finish at Glenn ever.

The Chiefs amasses 84 and one half points with Bob Mullen and Brett Haarala leading the way. Mullen captured second at the 155-pound weight class and Haarala fought his way to third at 126 pounds.

"Haarala and Mullen did a great job," said Canton Coach Dan Chrenko. "They worked very, very hard. The whole team wrestled well; I'm very pleased with our performance."

Other Chief efforts were: Todd Bartlett, fourth at 98 pounds; Tim Collins, sixth at 112 pounds; Kevin Decker, fifth at 119 pounds; Steve Hamblin, sixth at 145 pounds.

The Chiefs face Waterford Mott in their first home appearance tomorrow at 6:30 p.m.

A DEAL FROM STIHL®

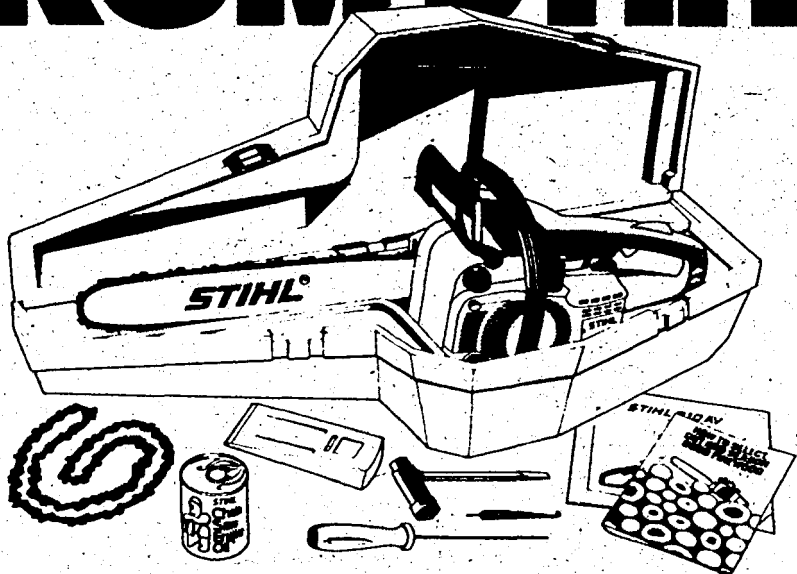

With the purchase of any Stihl® 010 or 015 "Bonus Special," you receive over \$45 worth of accessories at participating Stihl dealers. Offer includes matching carrying case, spare cutting chain, bar groove cleaning tool, file and handle, wedge, 8 oz. can of engine oil, wrench*, owner's manual*, and handy booklet about cutting firewood.
 *Standard equipment with all Stihl saws.

STIHL®

The World's Largest Selling Chain Saw.

Plymouth Construction Equipment, Inc.

41889 Ford Rd., Canton ½ miles west of I-275
 Between Lilley & Haggerty
 Daily 7:30-5, Sat. 8:00-5 Closed Sundays.
 Phone 981-0240

CLEARY COLLEGE

WINTERIZE YOUR CAREER

Special Winter Classes begin January 5



DESIGN A NEW ROOM BY SPRING
 (Room Setting Courtesy of Tyner Furniture Co.)



Since 1883

Interior Decorating 201
 Tue. & Thurs. 11-12:30 pm
 Wed. Eve. 6:30-9 pm



RE FOR WORDS

Medical Terminology 205
 Wed. Eve. 6:30-9 pm



TAKE THE TAXATION OUT OF YOUR TAXES

Income Tax Accounting 113
 MWF 11-12 pm
 Thurs. Eve. 6:30-9 pm

Also programs in accounting • Management • Secretarial sciences

Registration Now in Progress Call 483-4400

Cleary College 2170 Washtenaw Ave. Ypsilanti, Mi. 48197



CANTON SENIOR Dave Malek (10) is caught, in this picture, just before he is to drive to the basket for the Chiefs in their game with Churchill. (Crier photo by Rick Smith)

Canton cagers bump off Churchill in league clash

BY PATTY RADZIK

Turnovers by Livonia Churchill and a solid defensive performance by Canton were the contributing factors in Fridays boys' basketball contest in which the Chiefs dumped the Chargers, 66-55.

"Our defense dictated the tempo of the game," Canton Coach Craig Bell said after his team's second victory of the season and first Western Six League win.

Canton led in the opening quarter 10-6, behind the shooting of senior Sean Houle, who tallied eight points in the first few minutes of the game. Churchill's big men, 6' 6" center Scott Conrad and 6' 3" Chris Harvath, retaliated with points late in the first period and sent the Chargers up 16-13.

The Chiefs outscored Churchill, now 0-3, in the second quarter, 23-6, with both teams continuing to apply full-court pressure on defense.

After Dave Malek scored twice to put the Chiefs one point away from tying Churchill, the Chargers lost the ball four times in a row, in a time span of one minute and a half, which in turn sparked a scoring spree by Canton which was down 18-17.

Malek put the Chiefs ahead 19-18 with 6:48 left before the half, after Churchill's first turnover. Houle connected at the 6:22 mark on the second turnover. Steve Tuttle hit a basket with 6:05 on the clock, and Malek put Canton ahead 25-18.

The Chiefs held Churchill to just four more points in five minutes and went into the lockerroom at the half with a comfortable 36-22 advantage.

The third period was for the most part uneventful, each team scoring at every

opportunity. Canton, however, experienced some difficulty organizing its offense with 4:00 remaining in the third quarter, and the Chargers closed the gap to 10 points, trailing Canton 50-40.

"Churchill made a run at us, and we knew they would," said Bell. "We controlled the ball, held on and spread it. I felt we shut off their offense when we had to and came back."

Canton didn't stop the drip in the Chargers facet until early in the final quarter.

The Chargers cut the Chiefs lead to, 50-45, with 7:05 left to play as Churchill's Kelsey Thayer hit a lay-up.

Tuttle connected on two shots from inside, and Houle hit two free throws to lift the Chiefs up 58-45 by the 4:46 mark, and put the game out of reach.

Canton's last score of the contest came on a lay-up by Houle with 1:30 left in the game.

Houle was high scorer for Canton with 32 points. Malke and Tuttle added 12 points each and Matt Thomas added eight.

"Our guys who came in off the bench did a nice job," said Bell. "I was pleased with the way they played. I was able to play everyone, and we didn't lose any momentum."

Conrad was high scorer for Churchill with 19 points, and Ron Reed contributed 12.

Canton will face Northville this Friday at Northville. Game time for varsity is 7:30 p.m.

The Chiefs junior varsity team won its second game of the season beating Churchill 81-71.

Chuck Davis topped all Canton scorers with 18 points. Ron Reinas hit for 17 and Pat Murphy scored 16 points and collected 13 rebounds for Canton.

SUPPORT YOUR SALEM WRESTLING TEAM!

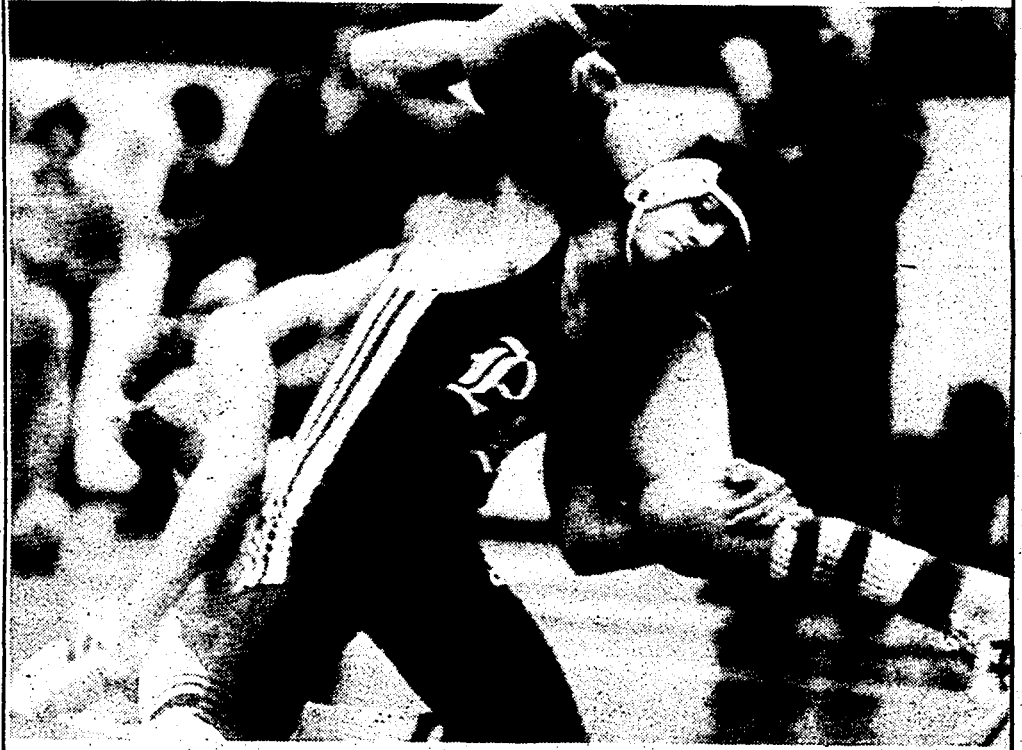

1979 DISTRICT & REGIONAL CHAMPIONS

1980-1981

SALEM WRESTLING SCHEDULE

DATE	OPPONENT	PLACE	TIME
Thurs. Dec. 18, 1980	Allen Park	T	6:30
Fri. Dec. 19, 1980	Wayne "B" Invitational	T	
Sat. Dec. 20, 1980	Wayne Invitational	T	11:00 a.m.
Tues. Dec. 30, 1980	Canton Invitational	T	11:30 a.m.
Sat. Jan. 3, 1981	Huron Quad	T	
Thurs. Jan. 8, 1981	Bedford	T	6:00
Sat. Jan. 10, 1981	Salem Invitational	H	10:30 a.m.
Thurs. Jan. 15, 1981	Dearborn	H	6:30
Sat. Jan. 17, 1981	N. Farmington Invitational	T	
Thurs. Jan. 22, 1981	Belleville	T	6:30
Sat. Jan. 24, 1981	Monroe Invitational	T	
Thurs. Jan. 29, 1981	Edsel Ford	H	6:30
Sat. Jan. 31, 1981	John Glenn "B" Invitational	T	12:00
Thurs. Feb. 5, 1981	Bentley	T	6:30
Sat. Feb. 7, 1981	Suburban-8	T.B.A.	
Sat. Feb. 14, 1981	Districts	T.B.A.	
Sat. Feb. 21, 1981	Regionals	T.B.A.	
Sat. Feb. 27 & 28, 1981	State	T.B.A.	

They Need Your Support
SEE YOU AT THE MEETS

PERSONAL INJURY LAWYERS

We specialize in accident and personal injury cases.

Over 35 lawyers associated with firm.

- Auto accidents
- No-Fault accidents (against your insurance company)
- Job injury cases (worker's compensation)
- Hospital negligence
- Medical malpractice
- Product liability (injury from defective product)
- Aviation accidents & injuries
- Social Security disability
- Federal injury claims

Call for an appointment at our Plymouth or Southfield Office

455-4250

No Fee for Initial Consultation

Sommers, Schwartz, Silver & Schwartz, P.C.

Rocks' surge in 4th flattens Bentley 45-40

With the score tied 22-22 at the half, Salem's basketball squad outscored Livonia Bentley 14-10 in the fourth quarter to defeat the Bulldogs, 45-40, in a Suburban Eight League basketball contest Friday night. It was the Rocks league opener for this season.

Scott Bublin was high scorer for the Rocks with 10 points. John Cohen added eight points and Mike McBride pitched in seven for Salem, now 2-0.

Mike Sharp led in rebounds for Salem pulling down seven, and also led in the assist department with four.

The Rocks next game is at Dearborn Edsel Ford Friday at 7:30 p.m.

The Salem junior varsity won its second game of the season on Friday, dropping Bentley, 59-54.

Glen Mendali was high scorer for Salem with 17 points and Jim Sinclair followed with 11 points. Rick Berberet added 10 for the Rocks.

Salem swimmers 2nd at West Bloomfield Relays

Only Suburban Eight League foe Trenton stood in the way of the Salem boys swimming team at the end of the West Bloomfield relays Saturday.

The Rocks at second, finished up with 60 points, while Trenton was close to 80. Livonia Stevenson was third out of the 12 teams.

"We've always done fairly well at the relays. They used to be the Redford Union Relays. Last year we were third," said Salem Coach Chuck Olson. "We swam pretty well, but we want to continue moving people around since it is early in the season still."

The 400-yard freestyle relay of Jim Kindree, John Thomason, Tim Harwood and Doug Kleinsmith were the Rocks lone first-place of the relays. The foursome clocked 3:37.4 for meet champions.

Ashley Long, Erik Kleinsmith, Brian McAninch and Gary Workman teamed for second place in the 200-yard breast stroke with an effort of 2:07.1.

Divers Joe Rudelic and Todd Riedel team for 195.2 points and a second place for the Rocks.

Bruce Harwood, Tim Harwood, Russ Shaffer and Doug Kleinsmith were second in the 400-yard individual medley with a time of 4:05.6.

Jeff Kleinsmith, Paul Neschich, Workman and Shaffer teamed for third in the 400-yard medley relay with a time of 4:01.9.

In the 200-yard backstroke relay, Bob Bowling, Paul Perkowski, Neschich and Bruce Harwood clocked 1:54.4 for third.

The Rocks also opened their 1980-81

dual season with a 107-65 victory over Redford Union last Thursday.

Bruce Harwood, Workman, Shaffer and Perkowski won the medley relay, 1:49.7, while Neschich, Long, Scott Stinebaugh and Jeff Walker were second, 1:55.6.

Perkowski won the 50-yard freestyle, 23.8 seconds, while Doug Kleinsmith was third for Salem, 24.4

Neschich won the 100-yard backstroke, 1:02.1, and Bruce Harwood was second. Workman won the 100-yard breast stroke, 1:08.1, and Long was third, 1:12.6.

Rudelic was first in diving with 206.9 points, while Riedel was second, 156.8.

Jeff Kleinsmith was second in the 200-yard freestyle, 1:58.1, and Tim Harwood was third, 1:58.2.

Shaffer was second in the 200-yard individual medley, 2:09.8, while Jeff Kleinsmith and Tim Harwood teamed again for second and third, respectively, in the 100-yard butterfly, at 59 and 59.4 seconds.

Shaffer was second in the 100-yard freestyle, 53.6 seconds, while Pat McMann picked up third in that race, 59.3.

John Thomason was second in the 500-yard freestyle, 5:40.6 and Kindree was third, 5:43.7.

Perkowski, Jeff and Doug Kleinsmith and Tim Harwood won the 400-yard freestyle relay, 3:34.5.

Stinebaugh, Mark O'Day, Duncan Mosher and McMann teamed for third in that race at 4:06.8.

Tomorrow the Rocks will face Canton at Canton. Meet time is 7 p.m.

This Saturday Salem will host the Plymouth Rotary Invitational swim meet. Diving will start at 10 a.m. with the finals at 1 p.m.

This Certificate Worth

ONE HUNDRED DOLLARS

Christmas Gift from

Gj Construction

applied to any contract over \$1000
(One Thousand Dollars)

Expires 12/31/80

- ADDITIONS
- DORMERS
- SIDING
- KITCHENS
- BASEMENTS
- ATTICS
- GARAGES
- CEMENT
- AWNINGS
- REPLACEMENT WINDOWS
- GUTTERS
- STORMS—SCREENS



Deal Direct with the Owner
FREE ESTIMATES

Gj Construction

453-1590

LICENSED

INSURED

Rushed . . ! Holiday Haircuts

- *No Appointments necessary
- *Open 6 Days a Week
- *Tues. & Thurs until 8 pm
- Walk Right in

Yankee Clipper

198 S. Main
Plymouth, MI
459-0060

Edward B. Trachtman
D.O.
Practice of Family Medicine

Serving the
Plymouth - Canton
Community
Plymouth Professional Building
9416 South Main Street
Plymouth, Mich., 48170
Office Hours Telephone:
by Appointment 455-2970

SALEM'S 126-pound wrestler Bill Ward (on top) looks to be in fine shape to make the kill against his Trenton foe. Ward won the match, but the Rocks lost the meet.



Line-up problems stymie Rock wrestlers--fifth at JG

Two injuries and having three wrestlers fall to make their weight cut deeply into the Salem wrestling effort at the Westland John Glenn Invitational Saturday as the team finished fifth.

New Boston Huron won the competition with 172 points. Glenn was next at 142 and a half, Lavonia Stevenson at 106, Farmington at 102 and Salem at 100 and a half. Canton was seventh.

Senior Rob Price received a nasty sprain on his ankle during his match with a John Glenn wrestler and had to default. Bruce Bachman injured his shoulder during one of his matches.

Steve Szilagyi had a first place at 167 pounds to brighten the Rocks effort. He beat Steiner from Farmington 9-6 after pinning Blackmore of Farmington Harrison, and Pond of Dearborn Edsel Ford. He also beat Peonoff of Stevenson.

Jeff Wojek was second for Salem at 98 pounds after he lost to Humus of New Boston in the finals 5-0.

Salem's 105 and 119 wrestlers didn't make weight. At 112 pounds, Dave Lucas won his first match over Rochester Adams then lost to No. 1 seeded Denny of Farmington and lost in consolation to a Wayne Memorial grappler.

Chris Chrysler, at 126 pounds, lost his first match to the No. 2 seceder, while Rob

He then wrestled for fifth and sixth places and lost to Piner of New Boston for sixth. Marty Piper, Salem's heavyweight, lost in the finals to Rice of New Boston, a defending state champion, 7-3, for second.

Earlier he had pinned Craig Geams of Canton, Disney of Grosse Ile and Nic-dwicki of Stevenson.

Last Thursday the Rocks opened their Suburban Eight League season with a 36-24 loss to Trenton.

"We just didn't have the kids in the line up. We were not well prepared. We lost three matches that we were ahead," said Salem Coach Ron Krueger. "The big thing for us now is to get the team on the mats and work."

The Rocks travel to Allen Park tomorrow for another league match. Match time is 6 p.m.

ENHANCE a ground floor opportunity to make you wealthy!

455-1007

\$, p.o. box 1007C, Plymouth, MI 48170

The Penn Theatre

All Seats \$1.25

PLYMOUTH, MICHIGAN

The Black Stallion (G) 7-9

Starts Fri: The Elephant Man (P.G.) 7-9:10 Sun. 2:40, 4:50, 7-9:10

THE SHIRT HOUSE

Jerseys
Women's Tops
T-Shirts
Lettering

\$1 OFF all Lions & Rose Bowl Shirts

Great Custom Gift Ideas!

located lower level
John Smith

MANY EXCITING GIFT IDEAS FOR EVERYONE!

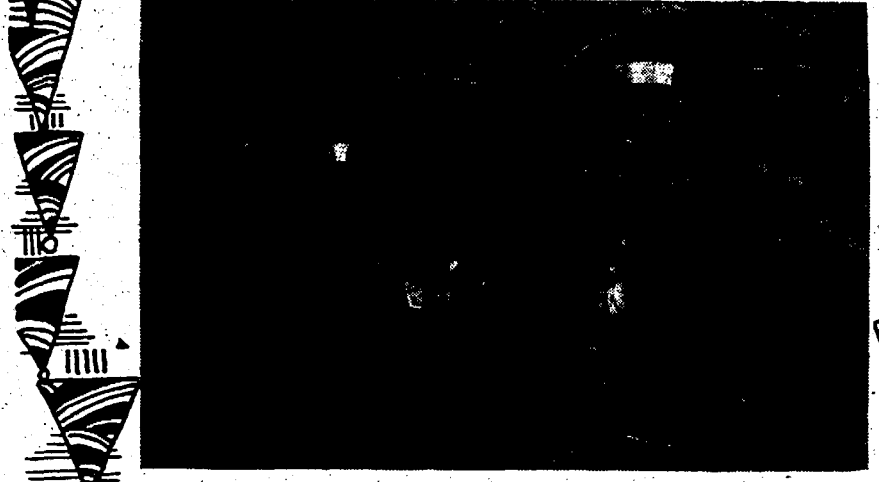

The Ultimate in BMX Bicycles

Mongoose Supergoose

- Footballs
- Jackets
- Basketball Equip.
- Woolrich Clothing
- Golf Equip.
- Arnold Palmer Golf Sweaters
- Baseball Equip.
- Socks and Caps
- Warm-up Suits
- Athletic Shoes
- Cross Country Skis
- Athletic Bags
- Bowling Shoes & Bags
- Skates
- Swim Suits
- Hockey Equip.
- Racquetball Equipment

Here's more Christmas Sporting Goods gift ideas

TRADING POST

PLYMOUTH

QUALITY SPORTING GOODS

BICYCLE SALES & SERVICE

453-0022

1009 W. Ann Arbor Rd.

Open Evenings till 8 pm
Saturday 9-6
Sunday 12-5

100% NATURALLY FLAVORED ICE-CREAM

Made in Plymouth with Quality and Pride
Open Christmas Day from 9 a.m.-3 p.m.
Carry-out only

453-4933 447 FOREST

HALF GALLON ICE CREAM \$2.09

Sherbet
Lime-Orange-Raspberry \$1.20 Qt.

Coca-Cola \$2.09 plus dep.
8 pk. 1/2 lit. bottles

Farm Fresh Guernsey Egg Nog \$1.29 Qt.

DRIVE UP WINDOW SERVICE Daily 7:30-10:00 Sun 8:00-10:00

DAVS A YEAR (Excluding Fountain Items)

BUTTER PECAN • CHOCOLATE ALMOND • LIME SHERBERT • STRAWBERRY CHEESE CAKE • CHOCOLATE HEATH • MINT

CHOCOLATE • MINT CHIP • BLACK CHERRY • VANILLA • STRAWBERRY

Amway® Has More Than Just Soap

- Make-up
- Toiletries
- Hosiery
- Jewelry
- Garden Products
- Nutrilite Food Supplements
- Cutlery
- Smoke Alarms
- Door Alarms
- Waterless Cookware
- Gift Albums
- Personal Shoppers Catalogue

Laundry & Cleaning Products
Both Home & Commercial
Money Back Guarantee

455-3366



Shop without going shopping... with your neighborhood Amway Distributor.

Chief swimmers open with tri-meet

The Canton boys swim team got its season off to a good start last Thursday, finishing second in a tri-meet held at Redford Union.

The Chiefs tallied 94 points to place behind RU, which won the event with 113 points. Clarenceville finished third with 65 points.

Two disqualifications, one in the 200-yard medley relay race and one in the 400-yard freestyle relay, cost Canton the meet, according to Coach Bill McCord. Canton was ahead at that point of the meet, and lost

a chance at adding a total of 14 points to its score by being disqualified.

However, there were several bright spots for Canton throughout the swim tourney.

Ton Hurley placed first in the 50-yard freestyle race with a time of 23.8 seconds. He also came in second with a time of 52.8 in the 100-yard freestyle race.

Bob Simrak won the 100-yard backstroke race, clocking 1:04.1, and finished second in the 200-yard freestyle event with a time of

2:04.9.

Glen Plagens won the 500-yard freestyle in 5:37.7.

Steve Gaggi placed second overall in the diving competition for Canton, scoring 160.4 points.

The Chiefs will swim their first home meet tomorrow night against Salem at 7. League action for Canton starts Tuesday, Jan. 13 when the Chiefs take on Northville at 7 p.m. in the Mustang's pool.

S&H Bantam icers 2nd at Melvindale

The Plymouth-Canton S&H Bantam AA hockey squad earned a second place in the Melvindale Turkey Tournament last weekend.

The finals pitted Plymouth against the Sabres USA. In a hard fought struggle that wasn't decided until late in the third

period, the Sabres won, 4-3.

The Sabres scored first with two goals in the first minutes of the first period. Plymouth came back to tie the game when Joe Carlson and Tim Osburn scored goals late in the first period.

In the second period, Tom Bryans scored Plymouth's third goal. The Sabres tied it

up again in that period and won on a goal by Mike Fowler in the third stanza.

The Plymouth squad started the tourney with a 5-4 loss to the Toronto Metro Blackhawks. The squad was leading 2-1 in the first period with goals from Dave Nelson and Don Perrin.

Toronto came back with two goals of its own to take the lead. John Smith then tied the game for Plymouth in the third period, but Toronto came back two minutes later to take the lead, 4-3.

Carlson, assisted by Rod Wells and Chris Belhart gave Plymouth new life with a goal to even the score at 4-4. It wasn't enough, though, as Toronto tallied one more goal to win.

Plymouth won its second game of the tourney, 9-1, over the Chicago Jets.

Chicago scored first, but Plymouth came back four seconds later in the first period when Chuck Norton slapped a shot from deep in the Plymouth zone that deflected off the Chicago goalie and into the net.

Plymouth then scored twice in the second period. Jeff Darrow and Norton provided the goals.

Plymouth exploded with six goals in the final period. Osburn had two, while Rob Simsick, Carlson, Rod Williams and Bryans added a goal each.

Plymouth smashed Cleveland North Olmsted 15-1 in its next game.

John Smith, Bryans, Williams, and Carlson paced Plymouth's blitz with two goals apiece.

Eric Seppi, Scott Oldfield, David Sivako, Dave Nelson, Osburn, Belhart, and Norton had one goal each.

The win advanced Plymouth to the semi-finals with Ann Arbor. The squad won that game 2-0 to make the finals. Smith and Sivako scored Plymouth's goals.

Midgets triumph

Plymouth's Midget B hockey squad squeaked by the Livonia Blues 5-4, Saturday on a last-second goal by defenseman Jim Breech.

Plymouth went into the third period with a comfortable 4-1 lead, but careless mistakes left the team tied at four with 24 seconds left. Breech stole the puck, skated down the ice and beat the Livonia netminder with seconds remaining, giving Plymouth its first league victory.

Goals by Jon Belhart and Tim Humphries gave Plymouth a 2-1 first period lead. Tallies by captain Ed Wojtan and Humphries upped the score to 4-1 after two periods.

Plymouth is now 1-1-1 on the season.



In the Dec. 10 issue of The Crier's sports section, senior Salem boys' basketball player Mike Sharp was identified as sophomore John Cohen.

Also, in the Dec. 3 sports pages, senior Salem basketball player Bill Newland was identified as sophomore Dave Houle. In that same issue it was said that the basketball had not won their Suburban Eight League title last year when in fact the Rocks did just that.

SALE ENDS DECEMBER 21

Plastic Coated Billard Barbells

save \$5

Reg. \$29⁹⁵ \$26⁹⁵

110 lb. set includes dumbbell bars. Spartan

Rollaway, Foldaway

1/2" Tennis Table

Reg. \$69⁹⁵ \$59⁹⁵

100 Only

Net not included. Official 5' x 9' size. Tournament green and fully striped. Solid bracing and folds easily for storage. Converts to playback for individual practice. 3/4" Tables. Reg. \$89.85 Now \$69.95

Jiffy Powered Ice Drill

Save, Easy to Use
8" Diameter
Compare at \$200.00

\$159⁹⁵

While Quantities Last-
No Rainchecks

EPPS

28843 PLYMOUTH RD., LIVONIA
Open Daily 9 to 9 - Sun. 12 to 5
SA 1-5828

2881 DIX AT SOUTHFIELD
Open Daily 9 to 9 - Sun. 12 to 5
RD 3-8828

OPENING DECEMBER 18

Michael Ilitch presents ...

PIZZA TIME THEATRE

THE GREAT ALL-AMERICAN PIZZA SHOW COMES TO WESTLAND!

It's pizza and a lot more!
It's Chuck E. Cheese and the fun loving, animated Pizza Time Players singing and laughing their way into your hearts.
It's an electronic entertainment center with exciting games (including Asteroids & Skee ball)
It's birthdays, graduations, anniversaries, parties - fun occasions of any kind.
It's food, fun and frolicking for the entire family.
It's Chuck E. Cheese's Pizza Time Theatre where Pizza's never been so much fun.

FREE
10 Game Tokens and
\$2.00 OFF
On the purchase of any
Large Pizza
COUPON VALUE \$4.50
Bring this ad in to qualify for discount. Offer valid thru 12/31/80

Pizza Time Theatre
208 S. Wayne Road
Westland, Michigan
(313) 474-8884
ASK ABOUT GROUP RATES!
1976 P.T.T., INC.

★ SAVE THIS VALUABLE COUPON ★

Serving

PLYMOUTH-CANTON

COMPLETE OFFSET
PRINTING SERVICE
featuring 3M 412 CAMERA

Call
453-6770

Pilgrim Printer

632 S. Main Plymouth

Michigan Ave. Bookstore

Adult

- Magazines
- Paperbacks
- Novelties

VIDEOTAPES

as low as \$34⁹⁵

8 mm Films

from
\$12⁹⁵

208 W. Michigan Ave.
Ypsilanti

Hours: 10 am-12 mid. Mon. - Sat
12 noon - 10 pm Sun.

482-9036

Rocks unable to overcome hot Jackson cagers

Cont. from pg. 46

and sank one of two tries for the Rocks lone point of a frustrating first period. Jackson tallied 11 points.

"I thought we were real tight in the first quarter. We just didn't play our game," said Blohm.

The Rocks turned on their energy flow in the second period. Moore sank two baskets, while starters Jacque Merrifield, Jan Mackenzie, Carol Ross and Cherly Sobkow added baskets later. Moore ended the Rocks first half with another bucket at the 1:54 mark and Salem was within one point, 16-15.

Jackson tallied seven points in that period including two free throws with four seconds left to make the spread 18-15 at the intermission.

"We had a series in the second quarter when we put some things together and started to get the ball inside and to Sobkow," said Blohm. "I don't know the reason why we stopped doing it. Good basketball teams like Jackson make you breakdown."

The Rocks could only tally six more points in the desperate third period of action. Ross had three of those points, while Moore sank two free throws and Merrifield sank one.

Jackson went wild in the third quarter. Secure on defense, their offensive game opened up. The squad scored 14 points in the eight minutes and led 33-21.

In the fourth period, Mackenzie started

off the Rocks with two buckets in less than two minutes. But then Moore fouled out at 6:16

Ross continued Salem's scoring with three points. Merrifield added a bucket along with Bonnie Sutherland.

Sutherland's bucket came with 1:25 left and Jackson far in front, 47-30. Jeanine

Papa ended Salem's scoring with one free throw with eight seconds left. Minutes before the four remaining Salem starters were replaced as the Rocks' bench players played out the final minutes.

In addition to Sutherland and Papa, Linda Lybarer, Sara Evans and Sue Remer played. Pam McBride also saw considerable

action throughout most of the game.

"We played six great games getting here. I can't be disappointed at getting to the semis but it may have taken its toll," said Blohm. The Rocks finished the season at 22-5.

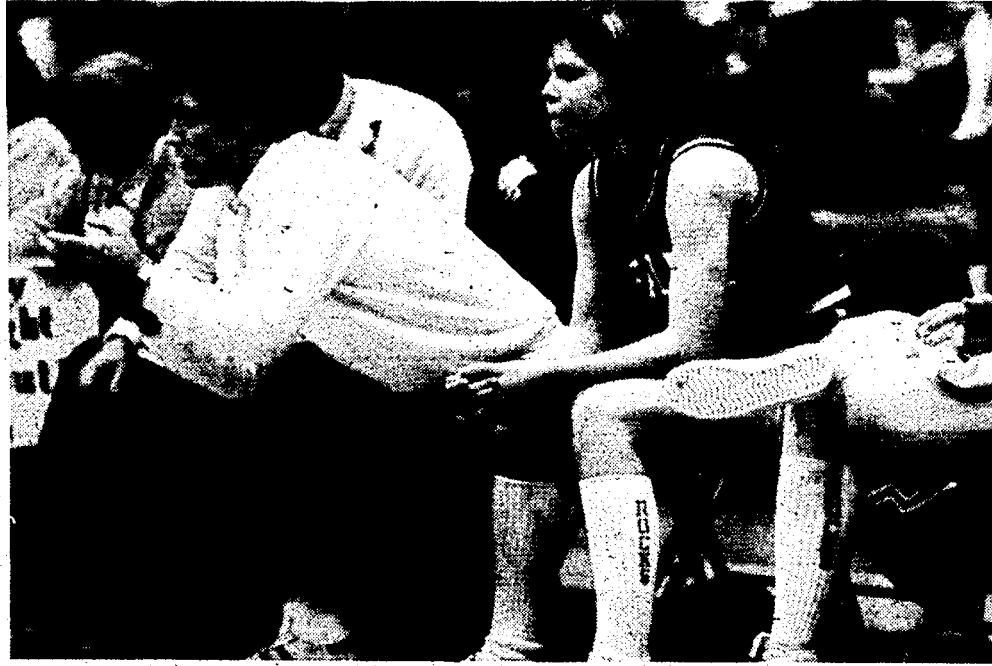

SALEM'S BENCH closely follows the developing action on the floor during the semifinals with Jackson. Jackson won the game 51-33. (Crier photo by Robert Cameron)

Hockey benefit

The Wayne County Sheriffs and the Plymouth-Canton Midget A team will face off Dec. 27 at 7 p.m. in an exhibition hockey game at the Plymouth Cultural Center. Tickets are \$1.

Soccer champs

Plymouth 3, the Wolverines, won the division two title of the Western Suburban Soccer League, for boys 12-years and under. The squad compiled a 7-1-0 record. They also won this year's Plymouth Cup.

Team members included Mike Ulaszek, Eddie Shuman, John Grannan, Mike Zaretti, Mike Gray, Frank Engel, Kevin Jaskolski, Jim Fordyce, Tom Barto and Matt Baun.

Also on the team were Todd Sheperd, David Livermore, Chi Ki, Robert Beebe, Billy Nottenkamper, Chris Thomas and Tim McCoy.

John Zaretti, Jack Gray and Dick Braun coached the champions.

\$3.50 for the first 10 words, 10¢ each additional word

Crier classifieds

Deadline: Monday 5 pm
Call 453-6900

Help Wanted

R.N.—YOU CAN MAKE THE DIFFERENCE— position available full time afternoons & midnights in Modern Suburban skilled Nursing facility. Competitive wages & excellent benefits including shift & charge nurse, differential paid & pension plan. Inquire about our educational opportunities also. Contact Kay Kermod R.N.

Looking for models for Jan 5th, 1981. All day—complementary hair cuts. For more information call Beautiful People Hair Forum 459-2880

INSURANCE

Commercial underwriting secretary. Top pay. Challenging position, involves property and casualty customers, account handling in our new office, new business renewals. We need a career professional who enjoys taking responsibility. Experience mandatory. Full benefits, promotion opportunities, bonus, profit-sharing. Business days— 994-4900. Nights— 973-9330.

CLERK TYPIST— K-Mart Corporation Canton Distribution Center requires a person to work in General office. Afternoon shift. Immediate opening. Excellent benefits. Call 459-0800 between 7:30 a.m.-4 p.m. for appointment. An Equal Opportunity Employer.

DATA PROCESSING DEPARTMENT— K-Mart Corporation Canton Distribution Center requires a person to work in Data Processing. Midnight shift. Immediate opening. Excellent benefits. Call 459-0800 between 7:30 a.m.-4 p.m. for appointment. An Equal Opportunities Employer.

In home Child care for 6 to 10 times a year when parents are traveling on business. Two children ages 4 & 10 experience & references a must, prefer non-smoker, needed for February. Call 453-0257 after 6 p.m. for interview.

Need one good residential painter with own equipment. Name, address and phone number to Box 1490 Plymouth.

ADVERTISING SALES REP.

Earn \$300-\$700 per week. No experience necessary. 30-40 years of age preferred. Must own dependable car. Do not apply if you're lazy. Call Mr. Pro Inc. (219) 397-2299 or write Mr. Pro Inc. P.O. Box 2097 East Chicago, Indiana, 46312.

Help Wanted

CHASE THE BLUES. Pay holiday bills selling Avon. Fun, good \$\$\$! 291-7862

Situations Wanted

Experienced Santa Claus will visit your home, party, etc. References. 420-0404.

Tutor wanted for High School calculus. Must be good. 981-2853.

Mature women wants babysitting in my home. I-275 & Hix Rd. Full or part-time. 464-1667.

Wanted

Plymouth Lions Club requires your donated household item for their annual Auction. Call 453-7800 for pickup.

Articles for Sale

Hearth glass fireplace doors, new partly assembled. 29-37" Width. 24-27" Height. \$43.00. 455-2149.

Pair snow tires 15" on Ford wheels. 453-4582.

Fireplace accessories; brass, traverse screen. 38x31"; andirons, tools & stand. \$30. 459-6726.

Lady Kenmore washer, 3 speed with Suds saver. \$45.00, Maytag dryer \$25.00, Roper stove with self-cleaning oven, aviolado, 2 1/2 yrs. old \$195, White Frigidaire refrigerator \$75.00. 453-8704.

Hammond C-2 Church organ with 2 large external speakers. Playing condition excellent. \$2450. Call 455-2300 or 453-1176.

Beautiful 1 carat Ruby surrounded by 16 diamonds set in platinum asking \$1,995. 453-7879.

Plastic Bundy clarinet with case, excellent condition. Call 453-7932.

Trixum 4 piece drum set with cymbals and accessories \$300 or best offer. 455-8669.

Lost & Found

Lost Dog—medium size part collie, female 1 1/2 yrs and answers to Dusty. Beck & Territorial. 453-4420.

FOUND: 2 Large Strings of outdoor Christmas lights, large type blubs. Call 455-9622.

Lady's eye glasses. Red & Black case. Reward. 453-4622.

Pets

Professional Poodle & Schnauzer grooming in my home \$8.00. Plymouth-Canton area 459-1241.

Services

Just moved, into the Area SUN—RAY Kennel Dog Grooming. 10 yrs experience. Scotty-Terrior puppies, quality temperament. 459-5581.

Storm windows & door sales. Thermopanes replaced. D.J. Industries. 453-1026.

BRIGHTEN UP YOUR HOME FOR THE HOLIDAYS. Painting, interior & exterior. For free estimate call Mr. Hardy 420-3207.

ACE RADIATOR SERVICE— open 7 days & evenings. Certified Mechanic. Repairing, Recoring, also gas tanks. 33509 Michigan Ave., Wayne. 326-6616.

Catering— Big or Small— home or hall — Everything homemade from Hors d'oeuvres to dessert. 261-4469.

TYPEWRITER—cleaning and repair. All models. Reasonable and guaranteed work. Call Jim 427-1067.

Sewing and alterations, specializing in bridal wear. Reasonable. 453-9392.

Does your house need a new look! Lowest prices in town. Get a new fresh look before the holidays—Interior or Exterior paint, wallpapering, carpentry work, what ever your needs. Call today 459-5563.

Assistance for problem pregnancy-free counselling services. Pregnancy testing. Helping women since 1972. Womens' Center 476-2772.

Services

FREE—Olde English Sheepdog mix puppies, to good homes. Call evenings 455-7935.

Firewood

Oak, Ash and Maple cut in 1979 delivered free 7 days a week for \$55 including free kindling. Same wood in quantities of 6 to 14 face cords for \$41 per. Will divide with neighbors and make driveway delivery to each. DELUXE MIX of Apple, Cherry, White Birch and at least three good varieties of seasoned hard wood is \$65. Straight Birch and/or Apple \$65 per. Phone HANK JOHNSON AND SONS anytime. 349-3018. If no answer, 348-3533.

All choice split mix hard woods seasoned one year. \$45.00 a face cord of two for \$85.00. Full delivery. 464-2433.

Just Good Dry wood with free Delivery. Oak—\$50.00. Mixed \$45.00. Dick Packard. 455-3822.

OAK & HARD MAPLE SEASONED & LONG BURNING, SPLIT & DELIVERED. \$40 FACE CORD. 453-2954 OR 437-8105.

Mixed Hardwoods \$45.00. Delivered, \$40 if picked up. 453-2360 or 455-5759. Bob Wagenschutz

Lessons

Piano lessons—experienced teacher has openings for beginners. Your house or mine. 455-5569.

Piano, organ, voacl. Mr. Ronnie Phillips 20 years experience, formally with Anderson Music. 453-0106 lead-sheets & arrangements.

Storage

Western Wayne County's finest mini-self storage. Servicing the greater Plymouth-Canton area. Storage Unlimited. 459-2200.

Office Space For Rent

Plymouth Office space—prime downtown corner, first floor, approximately 600 sq feet air conditioned, prior medical office. Immediate occupancy. 459-3434.

\$3.50 for the first 10 words, 10¢ each additional word

Crier classifieds

Deadline:
Monday 5 pm
Call 453-6900

AUTO UPDATE

459-9744
459-9745

ELITE COLLISION

Bumping and Painting
Insurance Estimates

FREE LOANERS

JIM 936 Ann Arbor Rd.
Plymouth

Tom's Custom Auto



Body Repair and Painting Inc. Imports

Reconditioning & Waxing
Interior & engine cleaning
453-3639 770 Davis
(old village, Ply.)

NOTHING BEATS THE OLD FASHIONED WAY of Buffing & Polishing Handwaxing Reconditioning



Quality service since 1959

DICK'S CUSTOM AUTO CARE

Call for Appointment 455-2660 9165 General Court (off General Drive) Plymouth

BODY SHOP

Complete Collision Work
Free Estimates

Grajek's Place

5775 Lilley Road
(one block North of Ford)
459-6769

Crier classifieds

Reach the people
in YOUR community

Call: 453-6900

or clip & mail this form today!

10 Words- \$3.50
Extra Words- 10¢ each

Deadline:
5 pm Monday for
Wednesday's Paper

Write Your Ad Here:

Mail to:
The Crier
1226 S. Main St.
Plymouth, Mi. 48170

Your Name _____ Phone _____

Address _____



Vehicles For Sale

1979 Omni 024. EXCELLENT CONDITION. AUTOMATIC. SUNROOF. RUSTPROOFED. LOW MILEAGE: \$4950. Call 729-2181.

1975 Pacer DL, AC, PS, PB, Stereo, speed control. Excellent Body and mechanical. \$1495. 459-4929.

Curiosities

Ed-Great after party party (I think)

UNCLE BOB: you're on for the seminar (we'll buy) and for continued constructive criticism (even when it hurts). What an honor! Thanks--Ed

JESSICA doesn't eat----vegetables in her soup.

SALLIE: when you have to send your mom and daughter over to kick you out of the office, you're working too hard!

Deb & Ron are great cookie makers! Thanks Phyllis. Ross & Rob

New Zealand in three years? Well its a pipe dream. Can't I have those?

Debbie and Ron -- Thanks for the cookie decorating and football. You can come over next time my mom bakes. Rob and Ross.

It's beginning to look alot like Christmas -- Thanks Ed.

Now that I'm in Karen's shoes on this type-setting machine I feel as if I have been lost for years, but know I'm found. Hello life is you living?

Ask Phyllis P. why this Saturday is so special...Then duck!

Hey Bob C. did you sleep soundly? Or were those dreams of a thousands little flash bulbs blasting through your brain?

Merry Christmas Emma love from Granny & Grandpa.

Hello Jennie-Merry Christmas from Granny & Grandpa.

Thanks Vicki and Sallie for responding to S.O.S-- Kamakaze Kid.

Old Village offers special December Christmas shopping on Sundays noon to 5 p.m.--Shop leisurely.

Curiosities

Remember Christmas? Shop Plymouth every day to assure the friendly service and fine merchandise you would like to give this Christmas.

KAREN S. -- "Would you like to borrow my alarm clock?" **JEAN**

Nancy: Where do those midget tires come from? Hormonal problems?

See the beautiful Staffordshire items at Florence Antiques. The Staffordshire tems are all gone. Sorry.

Karen, What a way to get out of a Christmas party. Hope you're feeling better. **The Staff**

Joyce, Why isn't the coffee ready yet?

DAN--I find meaning in nothing. The dread of something that is nothing, implies there is no meaning to everything. (Hurrah no meaning just being--Justflee)

Wind on water, star over air and ambience above deluge. Cluster.

Bob likes watching paint fires with exploding paint cans. Hot stuff.

Assuredly we have furnished a signal proof of our submissiveness; and even as former generations witnessed the utmost excesses of liberty, so have we witnessed the extremes of slavery; wherein our inquistors have deprived us even of the give and take of conversation. We should have lost memory itself as well as voice, had forgetfulness been as easy as silence. **TACITUS C. A.D. 88.**

EYE CATCHERS

Misties, candlelights, environmentals, and so much more to add that special touch to your wedding photography. Rawlinson Photography 453-8872.

The Tanbacks would like to wish you and your's a very Merry Christmas and an incredible New Year.

The Tanbacks proudly announce that Stroh's and Gillbey's have been named the official beer and liquor of the 1981 Tanback search for the American Dream. May your 1981 be totally up.

Bart, explain that black eye one more time.

Need one good residential painter with own equipment. Name, address & phone number to Box 1490 Plymouth.

Service Directory

<p>PAINTING—Ceiling and Wall Repair. References. Nine years in area. Free estimates—No job to small. 453-9475 or 721-1355 any-time.</p>	<p>Learn to Drive Teens and Adults MODERN School of Driving 326-0620 Classes held at Plymouth Cultural Center</p>	<p>SAMSONOW ELECTRIC Fuseboxes, Meters Installed Plugs, Switches, Dryers Ranges, Violations & Repairs 455-1166</p>
<p>Reserve this space</p>	<p>Professional Piano Tuning Registered Craftsmen Piano Technicians Guild Jim Alexander 397-8183</p>	<p>Chimneys Inspected Cleaned and Screened PAUL GLASS CHIMNEY SWEEPS "For Whatever Soots Ya" 525-5418 Woodburning Consultants</p>
<p>ALTERATIONS (Men's clothing and ladies tailored suits and slacks.) Regard less of where you purchased them... Satisfaction Guaranteed!</p> <p>LENT'S CUSTOM CLOTHING Plymouth, 453-5260, Our own tailor on premises</p>		<p>Shop Crier Classifieds</p>

YOU GET GREAT GIFTS AND HIGH INTEREST AT STANDARD FEDERAL SAVINGS

New! Checking Accounts with Interest

Until now, you've never had interest paid on your checking account. But on January 1, 1981, you'll have the chance to take advantage of a brand new service from Standard Federal Savings — checking accounts with interest. In addition to providing savings accounts which pay the highest rate available on insured savings, Standard Federal also offers the opportunity to earn the highest interest allowed on your checking account.



These accounts will earn 5 1/4% annual interest — continuously compounded — adding interest every month to your account for an effective annual yield of 5.467%. This is the highest interest allowed on checking accounts.

You may open an account in any amount. However, with a minimum balance of \$500.00 OR an average daily balance of \$1,000.00, you may write all the checks you wish, with no monthly service charge. (A \$5.00 monthly fee is assessed if you go below the minimum or average requirements).

- Each month you'll receive a detailed statement of your account which lists your checks in numerical order, your deposits, any service charges assessed and the interest earned during the statement period.
- Personalized checks are printed free of charge if you choose not to have your checks returned with your

monthly statement. There will be a charge for printing personalized checks if you wish to have your checks returned to you. With either option, you may select a style that provides a carbon copy of each check for your records.

- A permanent record of each check will be kept by Standard Federal Savings. If you need a copy for any reason, microfilm copies of as many as 25 checks per year (or all checks relating to an IRS audit) will be provided at no charge.

SPECIAL NOTICE TO CUSTOMERS 62 YEARS OF AGE AND OLDER:

Customers 62 years of age and older who have direct deposit of social security or other retirement checks into any Standard Federal Savings account will pay no monthly service charge on their checking accounts.

RIGHT NOW — with a deposit of \$1,000.00 or more, receive a gift FREE or at big savings just for opening or adding to any savings account, including an account that can be automatically converted to a checking account on January 1, 1981.

26-Week Money Market Certificate* Minimum Balance \$10,000.00

The interest rate is determined weekly and has three options for payment of interest; interest can be paid at maturity, or paid on the last day of each month and automatically transferred to a 5 1/4% regular savings account, or paid by check every month. Call (313) 643-9583 for the current rate.**

2 1/2-Year Money Market Certificate* Minimum Balance \$100.00

The interest rate is determined bi-weekly and compounded continuously giving the highest return available on these accounts. Call (313) 643-9583 for the current rates.**

Non-negotiable Savings Certificate* Minimum Balance \$100,000.00

Terms range from 14 days to 5 years with interest rates quoted by Standard Federal Savings on a daily basis. Call (313) 643-9562 for current rates.**

Retirement Savings Accounts*

IRA is a personal, tax-sheltered retirement savings program. It is available for any working person who is not currently participating in a private or government retirement plan. The Keogh Plan, a tax-sheltered retirement plan for self-employed individuals, is also available.

*Federal regulations require a substantial interest penalty for early withdrawal from certificate accounts and also prohibit the compounding of interest on 26-week money market certificates.
**The rate established at the time these accounts are opened is the rate in effect for the full term of the certificate.

GIFT	DEPOSIT OF \$1,000 OR MORE	DEPOSIT OF \$5,000 OR MORE
1. 24-Piece Party Glass Set	FREE	FREE
2. Borg Slim Contour Bath Scale	FREE	FREE
3. Springfield Weather Instrument	FREE	FREE
4. Royal Tool 4-Piece Plier Set	FREE	FREE
5. Sunbeam Quartz Cordless Mantel Clock (Batteries not included)	\$15.00	FREE
6. Rival 4-Quart Crockpot with Removable Stoneware	15.00	FREE
7. G.E. Digital AM/FM Clock Radio	15.00	FREE
8. G.E. Mist Hair Setter	15.00	FREE
9. Presto Hot Air Corn Popper	15.00	FREE
10. 10-Speed Osterizer Blender	15.00	FREE
11. G.E. Coffee Making Center	15.00	FREE
12. G.E. Spray Steam and Dry Iron	15.00	FREE

All these gifts are available when you open, or add to, an account at Standard Federal Savings. Select a free gift or pay the amount listed above for your gift. The number of gifts is restricted to one per account, and no individual may receive more than one gift. No gifts are allowed for funds transferred from one Standard Federal Savings account to another. Gifts cannot be mailed. This offer is good for a limited time only. Gifts offered subject to availability. Additional gifts are not available for purchase.

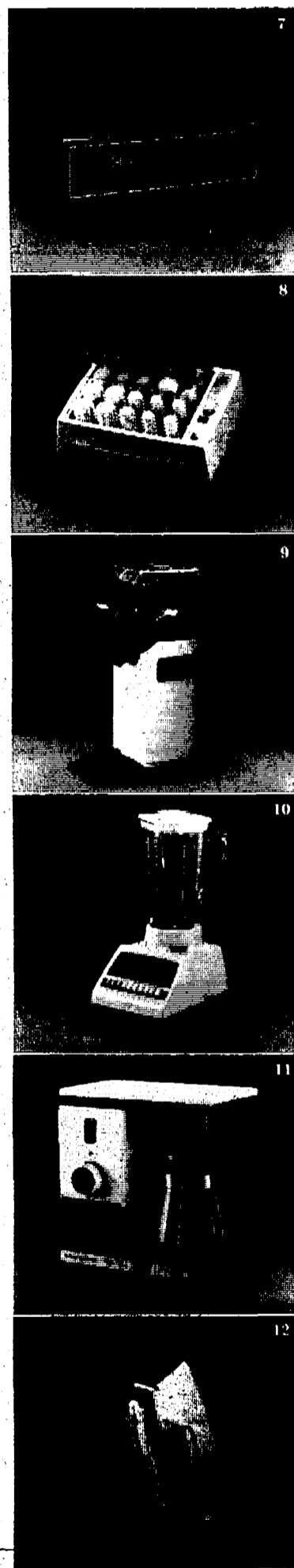
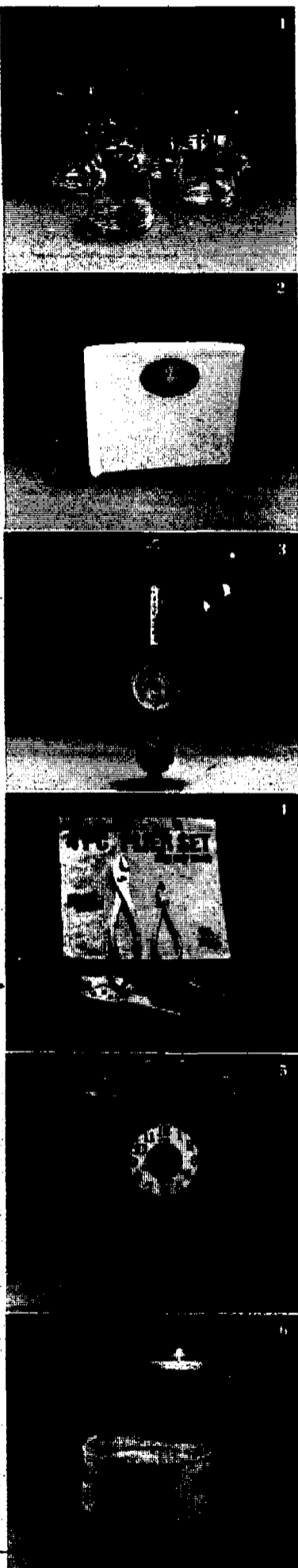

ANN ARBOR:
3201 Eisenhower Pkwy. at Packard
2630 Jackson Ave. at Maple
BELLEVILLE:
186 Main at Second
BIRMINGHAM:
50 West Big Beaver near Woodward
99 West Maple at Pierce
3700 West Maple at Laker
31049 Laker at 13 Mile
BLOOMFIELD HILLS:
825 W. Long Lake near Telegraph
BRIGHTON:
6510 E. Grand River near Chalk
CANTON TOWNSHIP:
44101 Ford Rd. near Sheldon
DEARBORN:
400 Town Center Dr. in the
Financial Plaza

DETROIT:
405 Griswold at Jefferson
DETROIT—EAST:
14628 E. Jefferson at Manistique
16630 E. Warren near Outer Drive
11511 Kelly at Whittier
DETROIT—WEST:
17540 Grand River near Southfield
25712 Grand River near Beech
14221 Greenfield near Grand River
10641 Joy at Manor
24224 Joy near Telegraph
18941 Schaefer near Nichols
FARMINGTON HILLS:
35410 Grand River at Drake
23950 Middlebelt at 11 Mile
32920 W. 13 Mile at Farmington
GARDEN CITY:
5811 Middlebelt near Ford Rd.

GROSSE POINTE WOODS:
19700 Mack Ave. near Cook
LIVONIA:
17230 Farmington near 6 Mile
13904 Middlebelt Rd.
(Open Late 1980)
MADISON HEIGHTS:
55 West 12 Mile at John R
NOVA:
43600 West Oaks Dr. near I-96
(Open Late 1980)
PLYMOUTH TOWNSHIP:
49509 Ann Arbor Rd. at Haggerty
ROCHESTER:
1310 Rochester near Avon
ROSELAND:
20895 12 Mile near Little Mack
ROYAL OAK:
1406 N. Woodward near 12 Mile

ST. CLAIR SHORES:
25515 Harper near 10 Mile
SHELBY TOWNSHIP:
4660 24 Mile near Shelby
SOUTHFIELD:
29405 Greenfield near 12 Mile
25123 Southfield near 10 Mile
SOUTHGATE:
13763 Northline
(Open Late 1980)
STERLING HEIGHTS:
38800 Schoenherr at Metro Pkwy.
44100 Schoenherr at Lakeside Mall
TAYLOR:
10700 Peiham at Allen Rd.
TROY:
2401 W. Big Beaver—Main Office
2699 W. Big Beaver at Coolidge
940 E. Long Lake at Rochester

VAN BUREN TOWNSHIP:
2089 Rawsonville near I-94
WARREN:
3900 E. 14 Mile near Ryan
30700 Schoenherr near 13 Mile
WATERFORD TOWNSHIP:
5619 Drake at Cambrock
WAYNE:
35150 Michigan at Wayne
WEST BLOOMFIELD:
6120 W. Maple at Farmington
WESTLAND:
7957 N. Wayne
at Hankin Blvd. N.W.
315 S. Wayne near Cherry Hill
YPSILANTI:
123 W. Michigan at Washington



7 OTHER OFFICES IN SOUTHWESTERN MICHIGAN

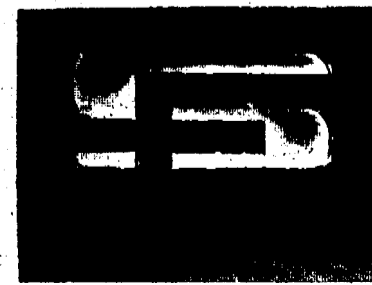

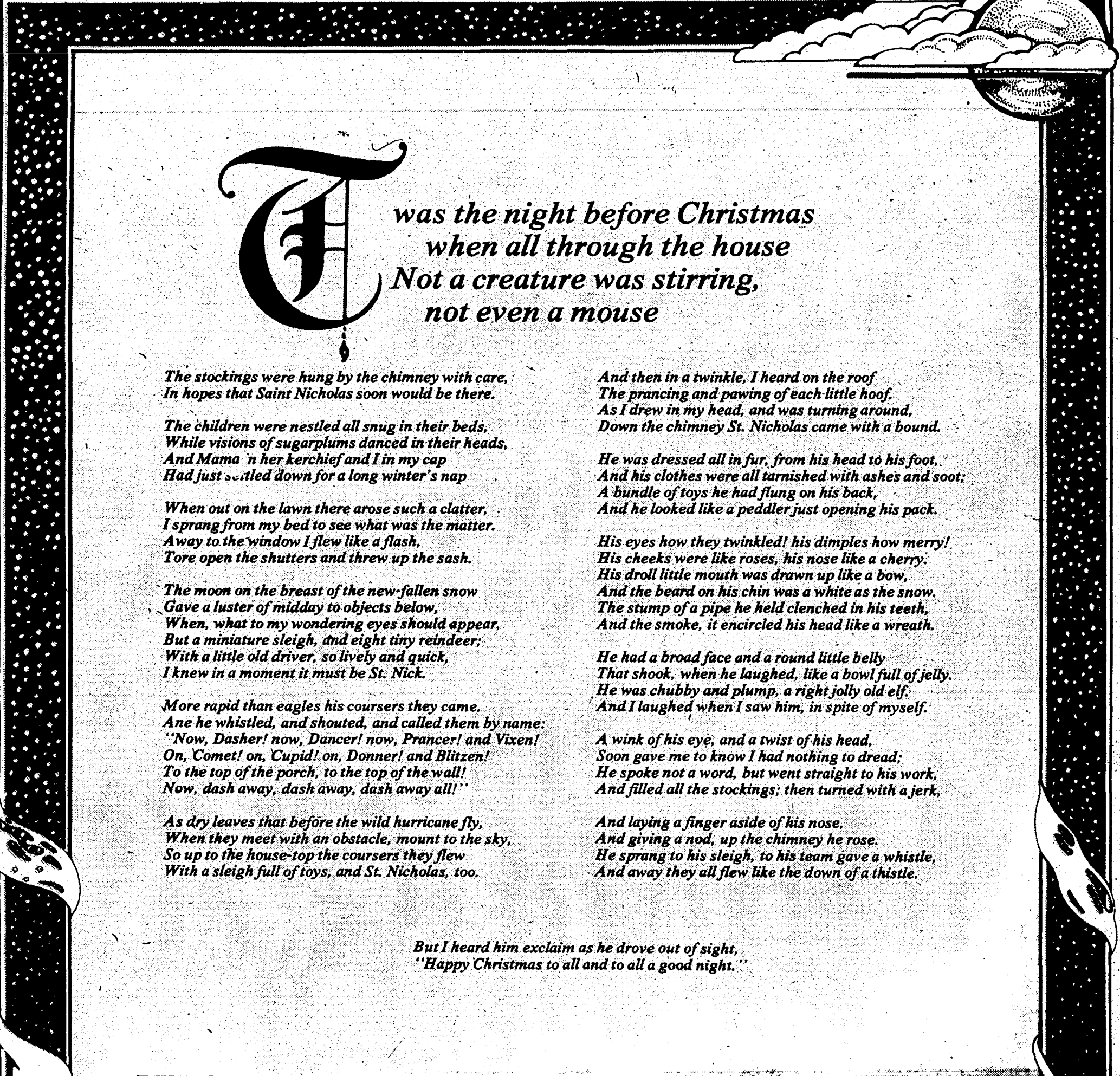

Twas the night before Christmas
when all through the house
Not a creature was stirring,
not even a mouse

*The stockings were hung by the chimney with care,
In hopes that Saint Nicholas soon would be there.*

*The children were nestled all snug in their beds,
While visions of sugarplums danced in their heads,
And Mama 'n her kerchief and I in my cap
Had just settled down for a long winter's nap*

*When out on the lawn there arose such a clatter,
I sprang from my bed to see what was the matter.
Away to the window I flew like a flash,
Tore open the shutters and threw up the sash.*

*The moon on the breast of the new-fallen snow
Gave a luster of midday to objects below,
When, what to my wondering eyes should appear,
But a miniature sleigh, and eight tiny reindeer;
With a little old driver, so lively and quick,
I knew in a moment it must be St. Nick.*

*More rapid than eagles his coursers they came,
And he whistled, and shouted, and called them by name:
'Now, Dasher! now, Dancer! now, Prancer! and Vixen!
On, Comet! on, Cupid! on, Donner! and Blitzen!
To the top of the porch, to the top of the wall!
Now, dash away, dash away, dash away all!'*

*As dry leaves that before the wild hurricane fly,
When they meet with an obstacle, mount to the sky,
So up to the house-top the coursers they flew
With a sleigh full of toys, and St. Nicholas, too.*

*And then in a twinkling, I heard on the roof
The prancing and pawing of each little hoof.
As I drew in my head, and was turning around,
Down the chimney St. Nicholas came with a bound.*

*He was dressed all in fur, from his head to his foot,
And his clothes were all tarnished with ashes and soot;
A bundle of toys he had flung on his back,
And he looked like a peddler just opening his pack.*

*His eyes how they twinkled! his dimples how merry!
His cheeks were like roses, his nose like a cherry.
His droll little mouth was drawn up like a bow,
And the beard on his chin was as white as the snow.
The stump of a pipe he held clenched in his teeth,
And the smoke, it encircled his head like a wreath.*

*He had a broad face and a round little belly
That shook, when he laughed, like a bowl full of jelly.
He was chubby and plump, a right jolly old elf,
And I laughed when I saw him, in spite of myself.*

*A wink of his eye, and a twist of his head,
Soon gave me to know I had nothing to dread;
He spoke not a word, but went straight to his work,
And filled all the stockings; then turned with a jerk,*

*And laying a finger aside of his nose,
And giving a nod, up the chimney he rose.
He sprang to his sleigh, to his team gave a whistle,
And away they all flew like the down of a thistle.*

*But I heard him exclaim as he drove out of sight,
"Happy Christmas to all and to all a good night."*

The Alternate Energy Center

Village Fireplace

Harvard Square
6074 Sheldon Rd. at Ford
Canton 459-3120

