

Read Crier's election endorsements...pgs. 24-28.



# The Crier

Community

October 29, 1980

The Newspaper with Its Heart in the Plymouth-Canton Community

Vol. 7 No. 38

25¢

Polls open 7 a.m. to 8 p.m.

## Local races to be decided Nov. 4

BY DAN BODENE

Canton voters will elect a new Board of Trustees as well as help decide county, state, and national races Nov. 4.

Local offices to be decided include those of township supervisor, clerk, treasurer, trustee and library commissioners. Also facing voters will be county, state, and national candidates as well as state proposal issues.

Polls in Canton will be open from 7 a.m. to 8 p.m. Voting stations for township precincts are located as follows: Precinct 1, at 128 Canton Center Rd.; Precinct 2, at the Recreation Building, 44237 Michigan Ave.; Precinct 3, at Gallimore School, 8375 Sheldon Rd.; Precinct 4, at Miller School, 43721 Hanford; Precinct 5, at Field School, 1000 S. Haggerty; Precinct 6, at Royal Holiday Mobile Home Park, 39500 W. Warren; Precinct 7, at Salem High, 46181 Joy Rd.; and Precinct 8, at Canton High, 8415 Canton Center.

In addition, voting stations for Precinct 9 are located at Eriksson School, 1275 N. Haggerty; Precinct 10, at Gallimore School, 8375 Sheldon Rd.; Precinct 11, at Honey Tree Club House, 8375 Honey Tree Lane; Precinct 12, at Hulsing School, 8055 Fleet St.; Precinct 13, at Miller School, 43721 Hanford; Precinct 14, at the Township Fire Hall, 41500 Warren Rd.; Precinct 15, at Walker Elementary, 39932 Michigan Ave.; and Precinct 16, at the Township Administration Building, 1150 S. Canton Center Rd.

Cont. on pg. 19

## Trick-or-treat Friday night

Plymouth-Canton parents should remember several steps to help make this Halloween a safe one, say local police.

- Children should be accompanied by an adult, older brother or sister.
- Costumes should be brightly colored, fire resistant and have reflector strips added if possible. Masks that obscure vision should not be used.
- Carry flashlights for added visibility to motorists.
- Only trick-or-treat in well-lighted and familiar neighborhoods.
- Cross the street only at intersections, and look both ways before stepping off the curb.
- Motorists are advised to drive extra-carefully and watch for children.
- Examine treats carefully.

Residents of the Plymouth-Canton Community can have treats examined by police at three locations. The Wayne County Sheriff's Department will inspect candy with a metal detector at the Hines Park mini-station on Edward Hines Drive at Newburg on Halloween night, Friday, Oct. 31.

In addition, Canton's Police Department will inspect candy, with a metal detector at the township's fire hall at Canton Center Road and Cherry Hill and at Hulsing School from 6 to 10 p.m.



KARLA GORMAN receives voting instructions from Dan McNew before casting her ballot at Canton High School's mock election yesterday. Ronald Reagan was victorious followed by Jimmy Carter, John Anderson, Ed Clark, Barry Commoner, and Gus Hall. They also chose incumbent William Ford over white supremacist Gerald Carlson in the 15th District Congressional race by 63 votes. Students supported Proposal B to lower the drinking age. (Crier photo)

## Call Crier election night

Want to find out who will be elected in Canton? Or Plymouth Township? Or who is running ahead in the 2nd District Congressional race?

Call The Crier, 453-6900, election night, Tuesday, Nov. 4 for results. The Crier staff will be answering the phones with the most up-to-date information available on election results.

BY PATRICIA BARTOLD

Highlighting the Nov. 4 general election ballot for Plymouth Township voters will be the battle between Democrat Carol A. Levitte and Republican Maurice Breen for supervisor.

Four members of the township's Board of Trustees will also be elected. The board will be charged with shaping Plymouth Township's future and direction over the next four years.

Key issues in these races have been police service alternatives, whether more industrial growth should be encouraged, the effect of the sluggish economy on the township's budget, and the idea of combining services with other neighboring communities.

Another factor to be decided by voters Nov. 4 -- which will effect Plymouth Township's future -- is the outcome of the seven state proposals and the four Wayne County proposals on the ballot. (See last week's Crier for a complete review of the "ballot proposals.")

The township's 13 precincts will be open from 7 a.m. to 8 p.m. Tuesday, Nov. 4. Judging by the more than 900 absentee ballots taken out by Monday, Clerk Esther Hulsing expects a fairly heavy voter turnout. There are about 14,500 voters in Plymouth Township.

A former Plymouth Township supervisor from 1970-72, Breen is currently a member of the Board of Trustees. He defeated in-

Cont. on pg. 9

## Complete sample ballots...pgs. 16-18



UNICEF will again conduct its campaign in area neighborhoods from Oct. 29 through 31. Young trick-or-treaters like (from left) Laura Johnson, Mary Beth O'Mara, Kelly O'Mara and Melanie O'Mara will

canvass the community after school hours to help benefit UNICEF, which helps feed and clothe needy children throughout the world. (Crier photo by Robert Cameron)

Check out Halloween bargains...pgs. 10-11

We'll pay more than any newcomer in town

We're here to stay

The shop for the collector and investor

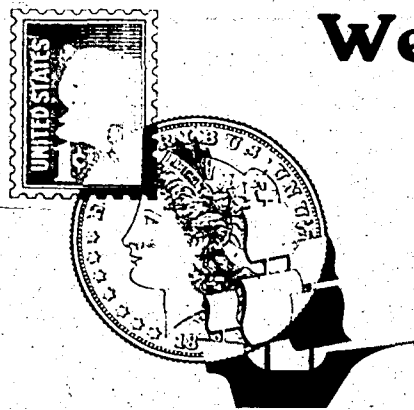

PILGRIM STAMP & COIN

729 W. ANN ARBOR TRAIL  
PLYMOUTH, MI.  
459-5275

We are not a Motel operation!

NEW HIGHER PRICES  
**CASH**  
FOR  
**ANYTHING**  
MADE OF  
**GOLD**  
OR  
**SILVER**

TOP CASH PRICES PAID FOR  
**JEWELRY**

We pay top cash prices for any jewelry made of gold or silver! Any jewelry marked 10K, 14K, 18K, 585, 750, 375, 925 as well as some unmarked jewelry is worth money to us! And we pay more for any unbroken gold chains or attractive re-usable jewelry! Bring in for our cash offer. Typical Prices on Used Jewelry  
Men's Class Rings.....\$25 to \$100  
Men's Wedding Rings .....\$25 to \$75  
Ladies' Wrist Watch without band.....\$15 to \$50  
Prices depend on weight, prices above are typical, for material marked 10K or 14K. Bring in unmarked for offer.

PAYING CASH FOR  
**SILVERWARE**

Top cash prices paid for any old sterling, regardless of condition—flatware, holloware, jewelry. We pay extra for complete sets or single pieces of many flatware patterns in good condition, and for good quality holloware. Bring in for our offer.

WE BUY  
**DIAMONDS**

We buy all cuts of diamonds old or New. For diamonds from .10 to .25 we pay \$1.25 to \$2.00 per point. Larger diamonds bring proportionately higher prices.

CASH PAID FOR

**GOLD COINS**

U.S. \$50.00.....	\$1500 to \$20,000 & up
U.S. \$20.00.....	\$625 to \$10,000 & up
U.S. \$10.00.....	\$310 to 8,000 & up
U.S. \$5.00.....	\$160 to 6,000 & up
U.S. \$4.00.....	\$8,000 to \$30,00 & up
U.S. \$3.00.....	\$275 to \$12,000 & up
U.S. \$2.50.....	\$110 to \$9,000 & up
U.S. \$1.00.....	\$150 to \$12,00 & up
World Gold Coins.....	Market Price

TOP CASH PRICES PAID FOR

**SILVER COINS**

Pre 1965

Dollars, average.....	From \$15.00
Half Dollar.....	From \$6.40
Quarters.....	From \$3.20
Dimes.....	From \$1.28
Half Dollars (1965 to 1969).....	From \$2.35

We also pay top cash prices for silver coins from Canada and other countries. Bring in for our offer.

CASH PAID FOR

**Rare Coins & Coin Collections**

As the area's leading dealer in rare coins, we are in constant need of good quality coins. Bring in your Collection for our cash offer.

**POCKET WATCHES**

We pay top cash prices for all pocket watches—running or not running, gold, silver or base metal. Paying minimum of \$100 for any repeater. Bring old watches in for our offer.

**NOW OPEN MONDAY**

Mon. Thru Fri. 9:00 to 6:00  
Sat. 9:00 to 2:00

**ALL Prices Subject to Market**

Evening Appointments Available  
All Transactions Confidential

# No local races or issues for City electorate

Although no local races are facing City of Plymouth voters Nov. 4, state-wide proposals, county, and national candidates will be listed on the ballot.

County Commission, Charter Commission, state and federal representation are among the races to be decided by voters at three polls in the city.

Voters in Precincts 1, 4 and 5 will vote at the Plymouth Cultural Center, 525 Farmer. Precinct 2 voters will cast their ballots at Starkweather School, 550 N. Holbrook, and the polling place for voters in Precinct 3 will be located at Central School at 650 Church St. All voting stations will be open from 7 a.m. to 8 p.m. Beulah Hanchett of the city clerk's office says absentee voters have turned out in greater numbers than last year, and the Nov. 4 turnout "looks like a heavy one."

In county races, William Joyner, the incumbent Democrat, will face Republican Darrell F. Kress for a seat on the County Commission from the 27th District. The County Commissioner can provide the local community with an out-area voice in the largely Detroit-controlled county government.

Another race of local importance will be for a seat on the county Charter Commission, also from the 27th District. In this election, Democrat Walter T. Hink will face Republican Hagbard "Bart" Berg. The Charter Commission will investigate possible re-structuring of Wayne County government.

A state Representative seat from the 52nd District, which includes Plymouth, will be sought by Republican Roy Smith and Democrat Judy Thiel. Smith, a long-time local politician and incumbent, will defend his representative's chair against Thiel, who

seeks to give a voice to women in the state legislature.

Carl Pursell, a Republican, will seek to retain his seat in the U.S. Congress from the 2nd District. His opponent in the race is Kathleen O'Reilly, who has stated her desire

to champion consumer causes in Congress.

In addition, voters will also decide several ballot proposals ranging from tax cuts to construction of new prisons. For a more complete look at these proposals, see the Oct. 22 edition of The Crier.



CARTOONS, a magic show, costume contest, prizes, donuts and cider were all featured at the Canton Parks and Recreation Halloween parties on Saturday. Shown are, from left, Rob Juergens,

five, who looks serious for a clown; and his brothers Stacey, seven, and Matt, three. About 160 kids attended the parties, held in two sessions according to age groups. (Crier photo by Robert Cameron)

## Police kill Wayne man after high-speed chase

A high-speed chase with cars traveling at 100 miles per hour through Wayne, Canton, and into Washtenaw County left a 37-year old Wayne man dead.

Lawrence Gordon Adams, 3436 Elizabeth, Wayne died as a result of gun injuries at University Hospital Monday night following the 20-minute chase Monday afternoon.

According to Wayne County sheriffs, Adams was being pursued following a shoot-

ing in a Wayne motel, after an attempted break-in.

The officer who finally succeeded in stopping Adams was Andrew Pruner, a deputy with the Wayne County Sheriff's Secondary Road Patrol.

Pruner gave the following account of the chase: Following the shooting incident, Adams headed east on Michigan Avenue at a high rate of speed. Seeing a police road-

block, he made a U-turn, heading west on Michigan to southbound I-275.

While heading south, he cut across the median to the northbound expressway, then headed west on Ford Road to U.S. 23 northbound.

At the intersection of U.S. 23 and Warren, two shots were fired at the police units which included the Michigan State Police, Washtenaw County Police, and at the Wayne

County Sheriffs. Adams fired his shotgun over his shoulder and out the window, striking a patrol car from the City of Wayne.

At U.S. 23 and Joy, he fired another shot, said Pruner.

At U.S. 23 and North Territorial, Pruner rammed Adams' white Toyota pick-up and fired six shots from his handgun. Then he placed it on the seat beside him.

When Pruner looked up Adams' shotgun was pointed at him, said Pruner. However, the police units "kept him so busy that he couldn't fire it," said Pruner.

After it was rammed, Adams' car crossed the median to the southbound lane and landed in a ditch.

"It was the first time I'd fired my gun at someone in the line of duty," said Pruner, an officer with 10 years' experience.

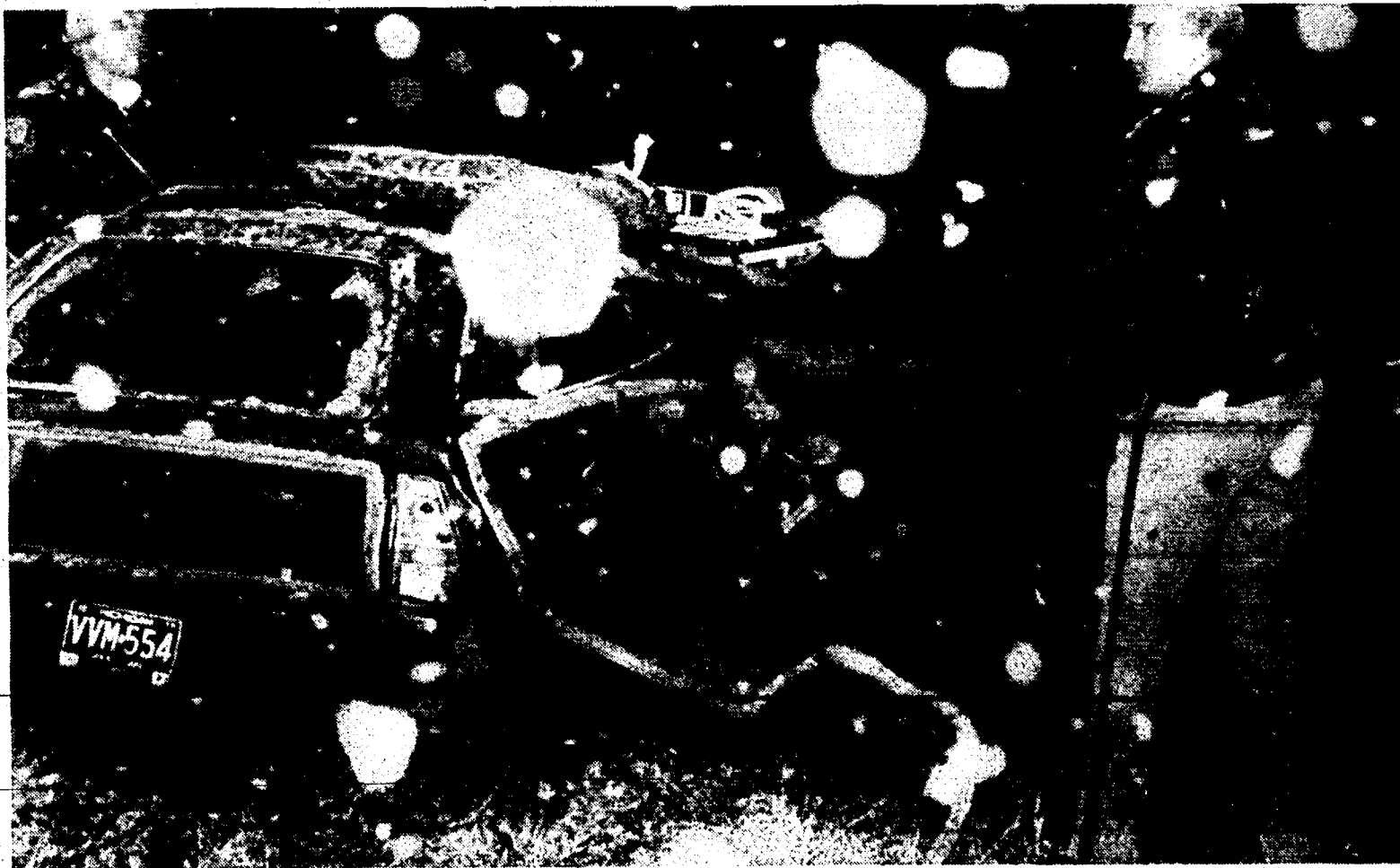

A FATAL ACCIDENT occurred at the intersection of Beck and North Territorial roads Monday at 9:30 p.m. While traveling southbound on Beck, a car, driven by Henry Peter Grabiec, 29, of Westland, failed to stop at the intersection, said Det. Walter Holowka of the Wayne County sheriffs. Passenger Joseph Shafer, 22, of Romulus, was killed in the collision, said Holowka. Their auto struck a car, eastbound on North Territorial, driven by Timothy Lates, 32, of Novi, said

police. Omar Harrison, 43, of Plymouth, was a passenger in the Lates' car, said Holowka. They were transported to St. Mary Hospital. The Grabiec car, above, was struck in the passenger's side, said Holowka. Snow mixed with rain was falling and can be seen in the photo. According to Holowka, a warrant charging Grabiec with either negligent homicide or manslaughter will probably be sought. (Crier photo by Phyllis Redfern)

## Prop. E OK: new prison at DeHoCo

BY CHAS CHILD

If Michigan voters approve Proposal E next Tuesday, a new state prison will be built next to the DeHoCo complex in Northville Township.

The proposal would fund the construction of four regional prisons in the state. And the DeHoCo site, next to the former women's division of DeHoCo, has been targeted for one of these prisons, said Sandra Johnson, an administrator at Phoenix Correctional Facility. Phoenix, a 311-bed state prison, was formerly the women's division of DeHoCo on Five Mile Road, west of Beck.

The new prison is scheduled to house 400 inmates in all levels of security, from maximum to minimum, said Johnson.

The state plans to build the other three prisons in Saginaw and Detroit (two), said a spokesman for the Department of Corrections in Lansing. Construction will be funded by a five-year increase in the state income tax of one-tenth of one per cent starting Jan. 1, 1981.

Proposal E also provides for the demolition of Michigan Reformatory, and increased correctional and preventive programs.



PLYMOUTH CHILDREN'S NURSERY will hold its annual Masterpiece Auction Nov. 3 beginning at 7 p.m. at East Middle School. Shown with some of the handmade items for auction are, front, from left, Jeff Pelczar, three; Mickey Platt, four; and David Patera, four. Back, from left, are Shirley Pelczar, Connie Platt and Nancy Patera. Professional auctioneers Jerry Helner and Lloyd Braun, both from Ann Arbor, will conduct the night's activities. (Crier photo by Robert Cameron)

## Chamber picks Board

The Plymouth Community Chamber of Commerce Board of Directors elected its officers recently for 1981.

Betty Stremich, proprietor of the Hillside Inn will serve as this year's president. First vice president will be Chuck Avis, owner of Wayside/Pick O' the wick, and second vice president will be Nick Aron of the Nawrot Pendleton Shop.

Margaret Wilson, Penn Theatre owner, will serve as treasurer, and Community Federal Credit Union Manager George

Lawton will serve as secretary.

The first order of business will be meeting for this year's annual chamber dinner, billed a "Community Celebration," on Nov. 5, at the Mayflower Meeting House. Guest speaker at the event will be former Ohio State Coach Woody Hayes, and music for dancing will be provided by the Wayne State University Band.

Tickets for the Community Celebration are available at the Chamber of Commerce office, 188 North Main. Donation is \$15 per person.

**25% off**  
on Student Hair Styling

(13 years & up must  
present I.D. card)

★ Retirees Discounts

**Yankee  
Clipper**

198 S. Main Plymouth Rd.  
Plymouth, MI Redford Twp., MI  
459-0060 937-2882

### The Community Crier

USPS-304-150  
Published each Wed.  
at 1226 S. Main St.  
Plymouth, Mich. 48170  
Carrier delivered: \$10 per year  
Mail delivered: \$16 per year.  
(Mailed at Controlled Circulation  
rates, Plymouth, Mich. 48170)  
Call 453-6900 for delivery.



The Crier's advertisers strive to honestly present commercial messages to our readers. If, for any reason, you find problems with a Crier ad, please call our office at 453-6900.

Crier advertising is published in accordance with these policies spelled out on the current rate card, which is available during business hours from our office at 1226 S. Main St., Plymouth. An advertiser's final acceptance by the publisher is conditioned only upon its publication.

# Glidden Color Naturals<sup>®</sup> Sale

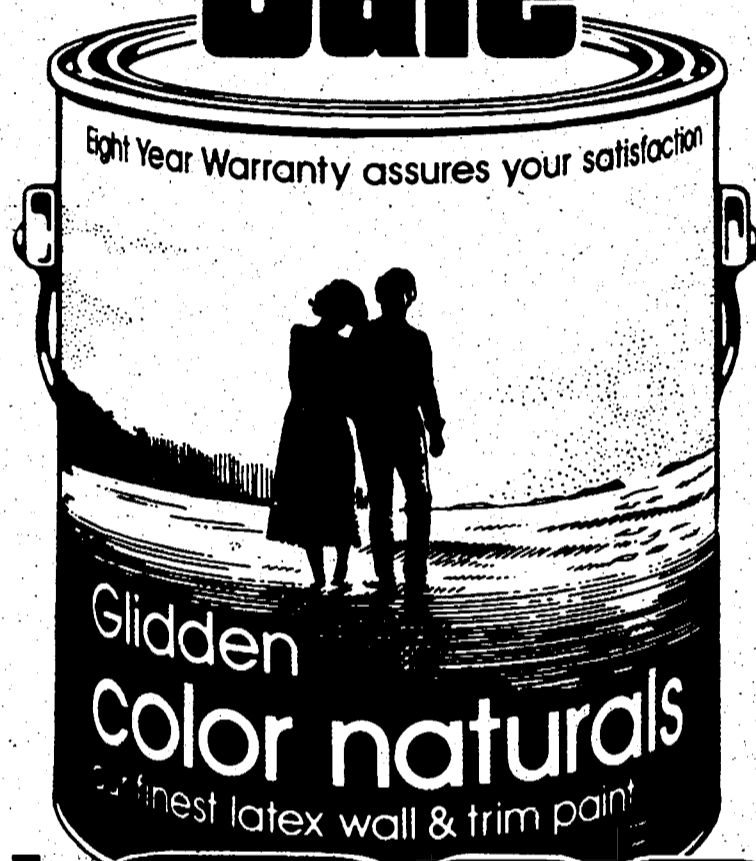

# \$0.99

GALLON  
Reg. \$16<sup>99</sup>

# SAVE \$7.00

**Glidden FINEST Latex  
Flat Wall and Trim Paint**

- One coat coverage
- Spatterless
- Durable wall & trim paint, fully scrubbable
- Limited 8-year warranty

**HOUSE OF FLOORS & WALLS**  
453-6667

# Opening Sale!

**NOW  
thru  
Nov. 12,  
1980**

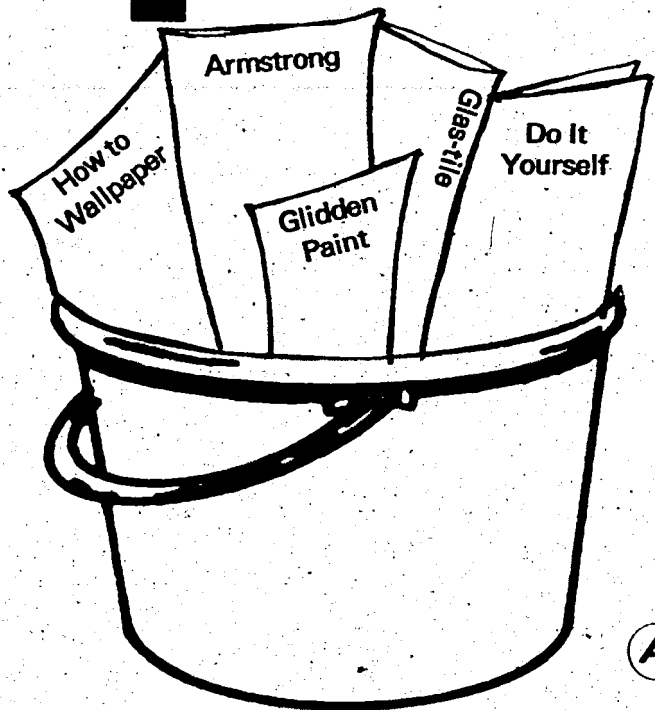

Let us Floor You Beautifully!

## HOUSE OF FLOORS & WALLS

Bucket of Decorating Ideas to the First **100** Customers  
**Company Representatives from . . .**



**Style - Tex  
Wall Coverings**

**Will be here Sat. Nov. 1 between 12:00-4:00 to answer your questions.**

**Check these Grand Opening Specials**

 <p><b>SALE!</b> Armstrong Solarian<sup>®</sup> Tile <b>79¢</b> Sq. Ft. Save 30¢ The Sunny No-Wax Floor That Comes In A Box ● Easy to install—simply peel, place and press. ● Dirt-, spill-, and scuff-resistant surface. Expires 11/12/80</p>	<p>Economy Excelon<sup>®</sup> floor tile <b>SALE</b> <b>29¢</b> Sq. Ft. Reg. 37¢ ● Economical and durable. ● Variety of colors. ● Adhesive required. Expires 11/12/80</p>	<p><b>DO-IT-YOURSELF</b> PLACE 'N PRESS<sup>®</sup> Vinyl-Asbestos Tile <b>45¢</b> Reg. 55¢ ● Easy to install! Simply peel, place, and press. ● Resists scuffs, stains, and grease. Armstrong Expires 11/12/80</p> 
 <p><b>WALLPAPER</b> <b>SAVE 20%</b> <b>\$279</b> (Single Roll) Sold in Double Rolls Only Over 50 Patterns &amp; Colors to Choose from Washable Expires 11/12/80</p>	<p><b>Z-BRICK<sup>®</sup></b> BRAND <b>Inca Red</b> <b>\$349</b> Reg. \$4.99 Box of 4 Sq. Ft. Expires 11/12/80</p>	<p><b>Mannington</b> <b>Vinyl Ease</b> <b>\$599</b> Sq. Yd. 12 ft. Widths for Easy Installation <b>NO WAX</b> Expires 11/12/80</p>
<p><b>GLAS-TILE<sup>™</sup></b> <b>\$449</b> Reg. \$5.99 12" x 12" Plate Mirror Tiles Highlight, brighten, and add dimension to any room. Available in a wide variety of patterns and colors. Expires 11/12/80</p> 	<p><b>20% off</b> All Wallpaper Books Expires 11/12/80</p>	<p><b>10% off</b> With this Coupon on all Non Advertised Items Expires 11/12/80</p>

## HOUSE OF FLOORS & WALLS

673 S. Main St. Plymouth

(NEXT TO FARMER JACK)

453-6557

Mon. 10-9  
Tues., Wed., Thurs. 10-6  
Fri. 10-9  
Sat. 10-6

(Closing Early Halloween 5:00)





CANTON'S CANDIDATES was attended by a nearly full house last Thursday night at Canton Township Hall. Hopefuls for county as well as township offices answered questions from local residents at the event, jointly sponsored by the League of Women Voters and the Canton Jaycees. (Crier photo by Robert Cameron)

# Canton supervisor candidates argue issues

**MARIANNE O. BATTANI**  
For Circuit Court Judge

- ☒ Rated **PREFERRED** and **WELL QUALIFIED**, Civic Searchlight
- ☒ Rated **SUPERIOR, RECOMMENDED** Urban Alliance
- ☒ Rated **WELL QUALIFIED** (highest ratings), Bar Associations
- ☒ Eight Years Circuit Court Trial Experience
- ☒ Supreme Court Appointee to Board of Bar Commissioners

Pd For by Battani for Circuit Court Committee  
515 East Larned, Detroit



**Circuit Court Needs**  
**RICHARD C. KAUFMAN**



"It did not take our committee long to recognize that Richard Kaufman is both a superior human being and a person long needed in the position of Circuit Court Judge. We as a committee believe you are both "Well Qualified and Preferred" above all other candidates."  
— Michigan Education Association-Wayne County —

Also Endorsed or Recommended by:

- AFL-CIO's United Transportation Union
- Wayne County Detectives Association
- Michigan Teamsters Union
- Detroit Police Officers Association

Paid for by Kaufman for Circuit Court Committee, 19952 Stratford, Detroit, 48221

**BY CHAS CHILD**  
James Poole, Republican candidate for supervisor of Canton, said "not one dime" of township money should be spent on the township's farmland-preservation program.

His Democratic opponent, incumbent Noel Culbert, defended the Board of Trustees's tentative decision to set aside \$250,000 of federal revenue-sharing money to get the program off the ground. "If the voters approve the program, we will have that as start-up money," he said.

The two clashed at the local League of Women Voters candidates night Thursday at Canton Township Hall, co-sponsored by the Canton Jaycees.

Culbert said township voters may face the farmland-preservation issue next year, perhaps on the same ballot with the proposed Wayne County charters.

In 1978, the electorate defeated by a 53-47 per cent margin a proposal to raise taxes four mills to buy the "development rights"

of about 5,000 acres of agricultural land in western Canton.

Poole, however, opposed putting the matter back before the voters. "In 1978, the people voted against it," he said. "What is the board going to do, put it on the ballot again and again until the people vote the way they want? A lot of the farmers don't want it. And 30 per cent of the land is owned by speculators. The voters will be subsidizing their profit."

Instead of the development rights program, Poole said he would introduce a phased-growth plan like the one used in Boulder, Colo. The Boulder plan limits building permits according to the township's ability to absorb growth, he said.

Culbert, on the other hand, said growth control is now a "dead issue" because the economic slump has slowed home-building. "But we should be prepared for future growth," he said.

A more important issue than growth is industrial development in the township, said Culbert. "Canton has made the basic efforts to get industry," he said. "We're going to get Super Sewer and more water pressure."

Poole also supported luring industry to Canton. The firms that do come in, however, should not be given "big tax breaks," he said. "I want revenue- and job-producing industries. And they should be placed along the I-275 corridor."

In other issues, Poole criticized the current administration for its high spending on legal fees, the growth of township government in the last four years, and errors in the township's commercial tax rolls.

"I'm not sure we need all the court cases we have," said Poole. "We should look into hiring a full-time attorney to see if we can save money." All of Canton's legal work now is done by hired outside attorneys.

Culbert replied that to hire a full-time in-house attorney and staff would cost about what the City of Livonia pays for its legal department: \$160,000. "That's about 50 per cent higher than what we're paying now," he said.

Poole said his taxes have gone up 100 per cent in the last eight years, while there has been an 80 per cent rise in personnel in Township Hall in the last four years.

Moreover, he said, there are omissions and underassessments on Canton's tax rolls.

**ELECT Gary ROBERTS**  
**CANTON TRUSTEE**



Support from many directions, such as:

**LABOR—**

- UAW CAP
- Teamsters D-R-I-V-E
- Detroit Building Trades Council

**ORGANIZATIONS—**

- Polish Central Citizens Committee
- 15th District Democrats

**FROM OUR LEADERS IN LANSING—**

- State Rep. Tom Brown
- Senator Faust
- Congressman Ford
- and Irene Murphy-Mich. Senior Citizen of the Year (78')

And those citizens who voted so strongly for me in the primary.

**HE NEEDS YOUR VOTE NOV. 4**  
**VOTE NOV. 4**

He has all the faults a good man should have.

Pd. for by the Committee to Elect Gary Roberts, 39500 Warren Rd. #248, Canton MI. 48187.

**RE-ELECT NOEL D. CULBERT**  
CANTON SUPERVISOR (Democrat)

*Culbert Cares about Canton*



Paid for by the Committee to elect Noel D. Culbert Canton Supervisor, 1706 Woodbridge Ct., Canton, Mi. 48188

Asked why there are so many fast-food restaurants along Canton's Ford Road, Culbert said many were OKd during prior administrations. "You can't prohibit them, but you can regulate them, which is what we are doing."

Culbert also defended his support of the Super Sewer system. "In the short run it will be more expensive," he said. "But by 1990, it will be vastly cheaper than staying in the Detroit system." Super Sewer, sponsored by the Wayne County Board of Public Works, is tentatively scheduled to serve communities in western Wayne County and the Huron River corridor from Belleville to Lake Erie.

# Canton treasurer candidates argue finances

James Kearney, Republican candidate for Canton treasurer, said Thursday he supports increased funding of township police and a "broad-based" industrial tax base.

His opponent, Deputy Treasurer Maria Falkiewicz, replied that she has started a very successful program to invest township funds.

The pair squared off at the Plymouth-Canton League of Women Voters candidates night at Canton Township Hall.

Both candidates agreed that growth control was a "dead issue" in Canton because the economic slump had choked off new housing.

Regarding farmland preservation, Kearney said the township's new zoning ordinance will help lower taxes. He supported permitting farmers to improve their operations with the use of township Economic Development Corporation (EDC) loans.

Falkiewicz said she liked the concept of buying the development rights of agricultural land in western Canton, but added, "there are too many questions and legal problems."

Regarding a recent copyrighted story in The Crier which showed at least one commercial building in Canton was missing from

the tax rolls, Falkiewicz said the treasurer's department is reviewing the rolls to make sure all property is listed. "We are double-checking with the county assessors," she said. Although the supervisor is the township's official assessor, the job has been farmed out to Wayne County.

"By law," replied Kearney, "the treasurer must make sure we're getting all tax receipts. I'm surprised that we didn't see to this."

Since April, Falkiewicz has managed the treasurer's department full-time. At that time the elected treasurer, James Donahue, gave up his management duties in Township Hall, but kept his seat on the Board of Trustees.

Kearney also said Canton should look into hiring a full-time attorney to cut legal expenses. "We should also review the court cases we have now," he said.

Even if the township hired a full-time attorney, said Falkiewicz, it would still need the specialized skills of some outside attorneys for such things as land-use cases.

Both candidates said they would vote against all three of the state tax-relief ballot issues next Tuesday, Proposal A, C, and D.

To lower township water bills, Kearney proposed reviewing the water and sewer

department's finances with an eye to transferring some costs to the general fund. He added that the water and sewer bills are high because substantial depreciation

costs of the system are included.

Falkiewicz said a large reserve is needed in the water and sewer fund to improve the system when needed.



**CAROL A. LEVITTE**  
**SUPERVISOR**

- Attorney and member of Public Corporation Law Section of Michigan State Bar.
- Accounting Background and Experience.
- Adjunct Professor at Madonna College.
- 9 Years Community Involvement as Volunteer Probation Officer 35th District Court, Tonquish Creek Manor Bus Driver, Community Fund Bellringer among others

**Vote Nov. 4th and make LEVITTE your choice**

Pd for by: Levitte for Ply. Twp. Supervisor  
42629 Five Mile Rd., Plymouth, MI 48170

## Plymouth Township Trustee

**DON'T JUST VOTE**

**BE SELECTIVE**

**ELECT**

**DONALD SKINNER**

Pd. for by Committee to Elect D. Skinner, 45501 Ann Arbor Trail, Plymouth.

/	[ ]
/	[ ]
/	[ ]
/	[X]

### Elect BERG



Governor Milliken discusses Wayne County reform with Bart Berg.

## Wayne County Charter Commission 27th District

BERG supports Governor Milliken's continued efforts to place the Road Commission under a county executive. He supports changing the method of appointment to insure greater responsiveness to the road problem long ignored in western Wayne County.

**VOTE Nov. 4**

**BERG**

Reliable- Committed- Dependable

Paid for by the Berg for Charter Commission Committee 48630 Michigan Ave., Canton, MI 48188

# Twp. supervisor hopefuls clash

BY PATRICIA BARTOLD

Plymouth Township needs to set a more positive tone for itself over the next four years, said Carol Levitte, Democratic candidate for Plymouth Township supervisor.

She spoke at Plymouth Township's candidates night last Tuesday, sponsored by the local League of Women Voters and the Lake Pointe Homeowners' Association.

Maurice Breen, the Republican candidate, also criticized the township's current administration. "I am dissatisfied with some administrative procedures, particularly the budgetary and financial controls," he said.

Breen defeated incumbent Supervisor Thomas Notebaert in the primary Aug. 5 by 170 votes.

Both Levitte and Breen favor unifying ser-

vices with other communities to cut costs for the township. A township resident for more than nine years, Levitte said unification of services should be started.

The township can maintain a separate identity from the City of Plymouth even if some services are unified, said Levitte. She said the Downriver Community Conference would be a good model to follow for unification. It has set up cooperative agreements between various communities for shared services.

Breen called for the township to retain its current status as a charter township. "It's the best form of representative government."

The city (of Plymouth) is the most natural community with which the township can share some services, he added.

Asked if the contract with the Wayne County Sheriff's Department should be continued, Breen said, "yes, continue it for now."

However, he favors considering alternatives over the next four years. He has proposed starting a one-man police force and then gradually hiring more officers, combining both civilian and hired officers for police protection.

Plymouth Township residents approved a one-mill levy for police protection in September, 1979. The three-year contract with the Wayne County Sheriff's Department started in May, 1980.

Levitte said the one-mill levy does not cover the costs of police protection. "It costs more than one mill," she said. She favored considering alternatives, such as contracts with neighboring communities like Salem, South Lyon, Northville, or Novi for police protection. "All (of these small communities) are in the same circumstances," she said.

Levitte criticized the administration's handling of the township's Hilltop Golf Course. The township proceeded with "undue haste" and "an unbusinesslike manner" with its expansion plans last summer, she said. As a result, John Jawor, who leases the course from the township, filed a suit to stop expansion work, she said. "Until it's on the books, I won't see it as successful business venture."

Breen defended the township's actions. "I want to use tax dollars to the best advantage and we did it with the golf course," he said. "We spent months planning it. It wasn't done in haste."

"We'll return the investment to township residents over the years," he added.

Levitte and Breen also clashed over the township's conduct in regards to open meetings. Levitte has filed a suit, charging the township with violating the Open Meetings Act on at least three separate occasions. "People can't know what's going-on (if the act isn't followed)," she said.

"I'm going to be taken seriously on this matter," Levitte, who is an attorney, added.

A resident for about 20 years and an attorney, Breen said, "The suit has just been filed. And, until it's settled, it shouldn't be given any weight."

"I've always been for open meetings," he added.

## Congress candidates don't show at forum

Citizens attending the League of Women Voters' candidates night Thursday at Canton Township Hall witnessed a "non-debate."

No candidates for U.S. Congress in Michigan's 15th District, which includes all of Canton, showed up.

Incumbent Democrat William D. Ford told the league his schedule was "too busy," while league officials said they received a telephone call from Republican Gerald Carlson saying he couldn't attend. There was no response from American Independent Aldi Fuhrmann, said the league.

Ford did write a letter to the league, in which he said he has strongly supported aid to unemployed autoworkers and the Chrysler Corp. loan guarantees.

Ford added that he worked to retain Saturday mail delivery, as well as aid to middle-income citizens for higher education.

The next session of Congress should restructure the tax system to encourage savings, Ford said.

## Pursell, O'Reilly trade cuts

Charging her with "being inconsistent", incumbent Republican Carl Pursell lashed out at Democratic challenger Kathleen O'Reilly at Plymouth Township's candidates night.

O'Reilly and Pursell faced off last Tuesday in the quest for the 2nd District's Congressional seat. John Wagner, the American Independent Party candidate, also spoke. James Hudler, the Libertarian Party candidate, did not show up. The 2nd District includes the City of Plymouth and Plymouth Township.

O'Reilly called for deregulation of the trucking and railroad industries to keep costs down. She does not support deregulation of the oil companies.

"It doesn't make good economic policy to regulate one field, but not another," charged Pursell. "It's inconsistent."

The two candidates also clashed on tax cuts. Pursell favors a major tax reduction to revive the economy. O'Reilly said "across-the-board cuts would hurt -- education particularly." She advocates a review of all

budgets for waste. "There are too many large corporations and people who don't pay taxes," she said. "Energy costs are also highly inflationary." She proposes increasing conservation programs, rather than spending it on synthetic fuels and laser fusion.

Pursell calls for balancing the federal budget to control inflation. He cited his work in developing laser fusion at the University of Michigan, saying "it's abundant, safe, and clean."

O'Reilly, an attorney, is campaigning as a consumers' advocate. "I could do so much more for you if I could vote for you," she said. "You'd know that Congress is looking out for you."

A moderate Republican, Pursell wants to continue his work in Congress. He cited his work in developing alternative energy programs, legislating a program for Talented and Gifted Students, and promoting his "Women's Bill of Rights."

"There are 270 attorneys in Congress -- perhaps that's part of the problem," he said.

Wagner provided a sense of comedy in comparison to the intensity of the O'Reilly-Pursell charges.

He called for government spending reductions and favors passage of the Tisch Proposal. He also wants to build more nuclear power plants. "More people have died at rock concerts than nuclear plant breakdowns," he said.

As for equal rights for women, Wagner said: "They have it pretty good in this country. . . Look at Iran."

## Re-Elect State Representative ROY SMITH



**HE'S WORKING FOR YOU IN LANSING AND IN THE 52ND HOUSE DISTRICT**

- ★ On political leave from the Ford Motor Company
- ★ 12 Years in Township Government— 8 years as Supervisor
- ★ 2 years as City Administrator
- ★ 8 years in county government— 1 year as Chairman of County Board
- ★ 12 years as State Representative in Lansing

**Keep Experience Working For You**

Paid for by Roy Smith re-election committee, 7768 Munger Rd., Ypsilanti, Michigan 48197

## CANTON VOTERS EXPERIENCED, KNOWLEDGEABLE AND DEDICATED

My Sincerest thanks to all who supported and helped nominate me for Supervisor in August. I hope that you and those who supported someone else will consider the issues, the options, and vote for me November 4, 1980 for

**JIM POOLE for CANTON SUPERVISOR**

Pd. for by Committee to elect Poole Supervisor, 44330 S. Umlerland, Canton, MI. 48187

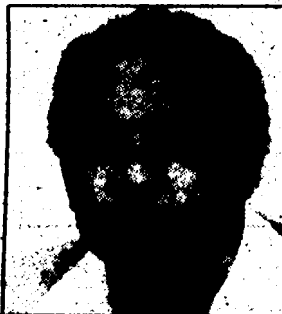



# Supervisor race tops Twp.

Cont. from pg. 1

Incumbent Supervisor Thomas Notebaert by 170 votes in the Aug. 5 primary.

Levitte, a resident for nine years, is a frequent observer at township board meetings. She has criticized township administrators for their lack of direction.

In the trustee race, four Republicans and two Democrats are vying for four seats on the board. Weyona Lee Fidge, Gerald Law, and Barbara Lynch are incumbent Republicans. The fourth Republican, Andrew Pruner, who was defeated for a trustee post in 1976, is again seeking election for a board spot.

On the Democratic slate, Patrick Downes and Donald Skinner are hoping to win trustee seats.

Traditionally a Republican stronghold, Plymouth Township has seen a new political twist with the emergence of three Democrats on the Nov. 4 ballot.

Incumbents Clerk Esther Hulsing and Treasurer Joseph West are running unopposed. Both are Republicans.

Also on the ballot are Donald King and Francis Radwick. They are running unopposed on the Republican ticket for the township's two constable seats.

In the race for U.S. Congress, 2nd District, which includes the City of Plymouth and Plymouth Township, Democrat Kathleen O'Reilly is trying to unseat Republican Carl Pursell. Both candidates are Plymouth Township residents.

Most township voters will vote in the 52nd District, state House of Representatives race in which Democrat Judith Thiel is challenging incumbent Republican Roy Smith for his seat.

However, the southeastern portion of Plymouth Township is included in the 37th District, which includes all of Canton Township. Democrat Thomas H. Brown is running unopposed for re-election.

Here's a list of the polls: Precincts 1, 2, 8,

Farrand School, 41400 Greenbriar; Precincts 3, 4, Allen School, 11100 Haggerty Rd.; Precincts 5, 12, Isbister School, 9300 N. Canton Center Rd.; Precincts 6, 7, West Middle School; Precincts 9, 10, Fiegel School, 39750 Joy Rd.; Precinct 11, First Baptist Church, 45000 N. Territorial Rd.; and Precinct 13, Lutheran Church of the Risen Christ, 46250 W. Ann Arbor Rd.

## Smith, Thiel square off

Voters in the 52nd state house district, which includes Plymouth and most of Plymouth Township as well as parts of Washtenaw County, have the choice next Tuesday between a woman's voice in Lansing or a tax expert.

That's how the two candidates, challenger Judy Thiel and incumbent Roy Smith describe what they offer in this election. Thiel is a Salem Township Democrat and Smith is a Pittsfield Township Republican who co-authored Proposal A on the statewide ballot.

At last week's candidate night, both candidates agreed that farmland should be taken off the property tax roles but disagreed on the Smith-Bullard Proposal.

Smith defended the proposal for shifting taxes for education from property tax to income tax and said, "I just don't know why" school officials have not endorsed the idea. "We put everything in it they asked for," he said.

Thiel said her opposition to the proposal was it was incomplete as it stands on the ballot. "It would take additional legislation," she said. "I support (Proposal) C." The third state-wide proposal would grant some property tax relief, raise the sales tax and earmark lottery money for education.

# CONGRESSMAN CARL PURSELL MAKING A REAL DIFFERENCE

## Leadership

SOME PEOPLE LEAD BY TALKING.  
OTHERS LEAD BY DOING.

### CONGRESSMAN CARL PURSELL IS A LEADER WHO GETS THINGS DONE.

● After only two years as our Congressman, Carl's legislative skill and bipartisan problem-solving approach resulted in his appointment to the House Appropriations Committee—one of the most influential positions in Congress.

● Congressman Pursell also won a seat on the key Appropriations Subcommittee which sets budgets for Education, Health and Human Services, and Labor Department programs—a vital position of influence for the people of the 2nd District.

● Congressman Pursell recently assumed a leadership position in the Northeast-Midwest Congressional Coalition. He has already led the coalition to two major victories in the House: a larger share of emergency fuel assistance funds (critical for senior citizens on fixed incomes), and directing more existing government contracts to high unemployment areas, such as Michigan, for new jobs.

● Carl continues to demonstrate leadership as an Executive Board member of both the Congressional Environmental Study Conference and the Suburban Caucus, and a charter member of the Steel caucus.

● Carl has been a leader for developing alternative energy sources, controlling inflation, balancing the budget, new jobs, and responsible tax reduction.



WORKING FOR US IN WASHINGTON  
WORKING WITH US HERE AT HOME

Re-Elect **CARL PURSELL:**  
**OUR CONGRESSMAN**

PAID BY PURSELL-CONGRESS COMMITTEE, P.O. BOX 7776, ANN ARBOR, MI 48107



Re-Elect

Barb  
**LYNCH**  
REPUBLICAN

**PLYMOUTH TWP. TRUSTEE**

Paid for by the Citizens for Barb Lynch, 10028 Wolfriver, Plymouth, MI 48170



VOTE **BREEN** PLYMOUTH TOWNSHIP SUPERVISOR  
**REPUBLICAN**  
NOV. 4th

Paid for by Breen for Supervisor, 763 Wing, Plymouth, MI 48170



# COME TO HALLOWEEN

**455-0210**  
**Retirees**  
**Ford-GM-Chrysler**  
**Your new Vision Benefits**  
**are now in effect...**

Our staff is available to explain your benefits

**Mayflower Optical Shoppe Ltd.**

817 West Ann Arbor Trail  
 Plymouth, Michigan 48170  
 "In the Mayflower Hotel"

**BUY EARLY AND SAVE!**

**SALE \$270<sup>00</sup>**  
 Reg. \$310.00

**3-hp Snow Thrower**

Clears a 20-inch path in no time with its heavy-duty engine and extra reserve power. Throws snow up to 18 feet.

**Nothing runs like a Deere®**

Sale Good till Nov. 15, 1980  
 Deposit will hold till Dec. 1, 1980

**CANTON POWER EQUIPMENT**

46600 Ford Rd., Canton, Mi.  
 1/2 Mi. W. of Canton Center 453-0295

**Curio Console**  
 with Attached Mirror

For that small space in your hall or living room. Only 19 1/2 inches wide, 11 inches deep and 70 1/2 inches high. Fruitwood Finish, Etched Glass Doors, removable glass shelf, lighted interior, white finished inside decorator back, brass plated hardware.

**SPECIAL SALE**  
**SAVE \$100**

Please allow 6-8 weeks  
 If not in Stock

**TAKE WITH \$212<sup>50</sup>**  
 Reg. \$312.50

**Sale Extended to Nov 8th**  
**Walker & Buzenberg**

Furniture Sales  
 240 North Main Street-Plymouth-459-1300  
 (Next to Kroger's-Near I-96 & I-275)  
 Hours: Mon., Thurs., Fri. 10-9 Tues., Wed., Sat. 10-6

**NO TRICK JUST TREATS**  
 Beautiful Framed  
 Decorative Mirrors  
**10% to 20% off**  
 (all mirrors in stock)  
 Sale Ends November 12

**Plymouth Glass Co.**

Glass of All Kinds  
 Open Wednesdays til 8:30 pm  
 Saturdays til 1 pm  
 GL 3-3434

1382 S. Main at Byron • 1 block N. of Ann Arbor Rd. Plymouth

**Halloween Day Special**  
**20% off Everything**

Except Copies & Printing

Mon.-Fri. 9-9  
 Sat. 9-6  
 Sun. 10-5

Coupon Valid Oct. 31 Only

**Canton Office Supply**

5804 N. Sheldon Rd.  
 Located in Harvard Square  
 Canton

**455-8970**

**Halloween Carpet Sale**

- ★ **Citadel** Reg. \$10.50 per. sq. yd. **\$8<sup>95</sup>** per. sq. yd.
- ★ **Seascape** Reg. \$11.95 per. sq. yd. **\$9<sup>95</sup>** per. sq. yd.
- ★ **Crescent Cove** Reg. \$11.95 per. sq. yd. **\$9<sup>95</sup>** per. sq. yd.
- ★ **Bombay** Reg. \$11.95 per. sq. yd. **\$9<sup>95</sup>** per. sq. yd.

**And Many More Specials...**  
 Prices Reduced on Padding & Installation with Purchase of New Carpet

**Plymouth Carpet Service**  
 (Formerly Plymouth Rug Cleaners)  
**1175 Starkweather**  
 453-7450 (Old Village)

# THE GREAT SALE



Happy Halloween from

**BROWN BERRY**  
Natural Bread  
THRIFT STORE

**31221 FIVE MILE**  
near Merriman, Livonia

Breads Baked with  
Natural Ingredients,  
Pure Vegetable  
Shortening, and No  
Artificial Preservatives

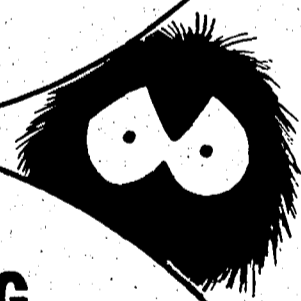

**FREE DRAWING**  
for our 5 ft. **TOY FILLED**  
**GIANT PUMPKIN**

Drawing Date Oct. 31, 1980 • Croutons • Bread Sticks • Stuffing Mix • Penn Dutch Cookies

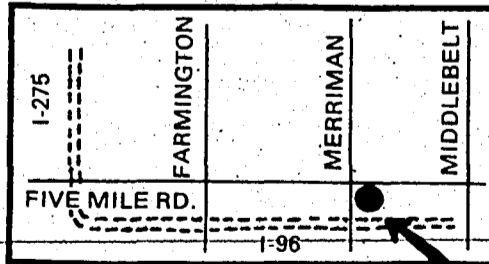

Come in and fill out  
your free entry  
• No Purchase Necessary •  
Open Daily  
9-7  
Saturday 9-6  
Sunday 10-5



**25¢ Off**  
**1 Loaf of Bread**

your choice  
(except Sun & Tues)  
expires Nov. 8, 1980

**Dave's Carpet Service**  
**Great Pumpkin Sale**

**10% on all Labor**  
**10% on all Carpet**  
**25% on all Pad**



**SAVE**

**Lee's-Armstrong-Presto**  
**Edilemans-Magic-Downs**  
Sale Ends Nov. 15  
**640 Starkweather 459-3090**

**It's our Anniversary**  
**All Regular Merchandise 20% off**

Sale thru Nov. 1st  
**Coats • Dresses • Suits • Lingerie**

**Kay's**  
of Plymouth

846 W. Ann Arbor Trail  
Plymouth, MI 48170  
453-7855

Daily 9:30-6  
Friday til 9 pm

Use your Visa,  
Mastercharge, or  
open a Kay's charge

The largest Selection and sizes of pumpkins in Canton Township. Fresh Cider and home-made Doughnuts.

**BORDINE'S FARM MARKET**  
Corner of Ford and Ridge Roads, 2 miles west of Meijer Thrifty Acres on Ford Rd.

We Sell Pumpkins Wholesale

OPEN: Mon.-Fri. 1:30-8:30  
Sat. & Sun. 10:00-8:30  
Farm: 495-1098

**This AD Worth 25¢**

toward the purchase of your pumpkin  
(one per family please)



**Bordine's**  
**Farm**  
**Market**

# friends & neighbors

## PCAC art for rent beats the high cost of culture

Have you ever wanted to make your house or room look more "art-ful" but can't afford Metropolitan Museum fees?

The Plymouth Community Arts Council has a solution for you.

With the support of a state grant from the Michigan Council for the Arts, the PCAC sponsors an art rental gallery located on the second floor of the Dunning-Hough Library on Main Street in Plymouth.

Established in March, 1978, the gallery now features 82 original works purchased from Michigan artists at area shows, and 55 reproductions from various art periods.

Judy Lewis of the PCAC says the goal of the rental gallery is to "get art into more homes and local businesses." Eventually, she says, the PCAC would like to have a gallery open more than one day a week.

Currently, the gallery is open every Wednesday from 10 a.m. to 9 p.m.

Three divisions of art works are available: original works rent for \$3 per month; reproductions go for \$2 per month, and consignment works rent for \$5 monthly.

Consignment pieces are art works owned by the artist and selected for rental, and all are for sale. Many of the consignment works were done by local Three Cities Art Club members.

Up to three pieces can be rented, and renewed for one month. New acquisitions are displayed for a month before renting.

Art works include oils, watercolors and lithographs in contemporary and modern styles. Lewis explains the pieces are suitable for homes and businesses, and can be enjoyed by adults and children.

Some of the works are apparently enjoyed

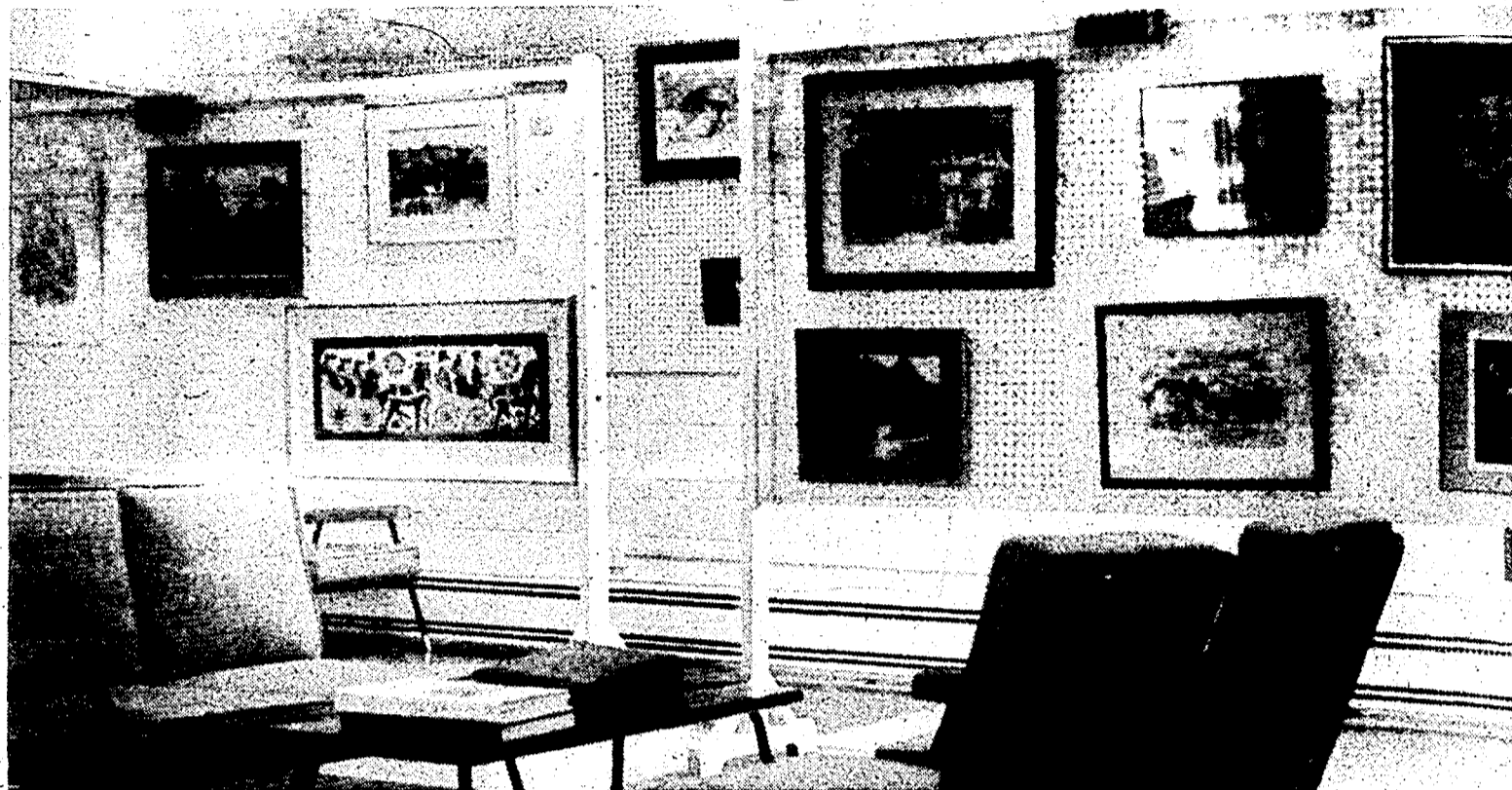

ART produced by Michigan artists are among the many offerings at the Plymouth Community Arts Council rental gallery, located upstairs at the Dunning-Hough Library. Works can be rented for nominal fees

for up to two months at a time, and include choices of consignment and reproduction works in addition to originals. (Crier photo by Dan Bodene)

with more than a passing fancy. Lewis relates a story of a renter so attached to a particular work she took it with her out-of-town, returning it when she came back to town. Some people, Lewis says, become so attached to a painting that they employ neighbors to

rent the work after the one-month renewal is up. Various works are so popular they are seldom seen in the gallery, she adds.

For prospective renters, photo books are available for viewing pictures available for rent.

Gallery organizers Joyce Foust, Bess Decker and Charlene Tobin have certainly come a long way since the days they did all of the framing for the art works -- now anyone can have good art in the home where it can be enjoyed at a nominal fee.

## We've Outlined A Great Thanksgiving Feast.

Plan to share the full feast with us on Thursday, November 27 — in your choice of settings. The Grand Ballroom: a festive Thanksgiving Buffet with all kinds of treats, including roast Baron of Beef, roasted ham with raisin sauce, roast turkey and dressing — with all the trimmings, from fall

vegetables to our bountiful salad bar, plus, of course, the best-loved traditional desserts. (From 12:00 - 5:00 p.m.; Adults: \$8.95, Children 4-12: \$5.95, Children 3 and under: free; prices include tax and gratuities.)

Or if you prefer: the Jolly Miller Restaurant, where we will serve a special roast turkey dinner, as well as your favorites from our menu. (Seatings at 4:00, 6:00 and 7:30 p.m.)

Both will be memorable — as family and friends gather to enjoy the picture perfect feast we've filled in beautifully — to the last detail. For reservations, call 459-4500.

**Plymouth Hilton Inn**  
 Five Mile and Northville Road, Plymouth, MI 48170

All Seats \$1.25  
**The Penn Theatre**  
 PLYMOUTH, MICHIGAN  
 Ends Thurs.  
 Herbie Goes Bananas (G)  
 7-9  
 Starts Fri.  
 My Bodyguard (P.G.)  
 7-9  
 Sun.  
 3-5-7-9

### Marquis Theatre

presents  
 One of Broadway's Biggest Hits!

Live on Stage

### "DRACULA"

THE PERFORMING  
 ARTS GUILD

Thursday, October 30 -  
 8:30 P.M. \$4.00

Friday, October 31 -  
 8:30 P.M. & 12 Midnight \$4.00

Saturday, November 1 -  
 8:30 P.M. & 12 Midnight \$4.00

Sunday November 2 -  
 2:30 P.M. - Childrens' Mat. \$2.50

**COSTUME CONTEST  
 AT MIDNIGHT SHOWS**

1st Prize - 50 Movie Tickets  
 2nd Prize - 30 Movie Tickets  
 3rd Prize - 15 Movie Tickets

Day 349-8110  
 Evenings 349-0668

# tell it to Phyllis



## Great Pumpkin watchers unite!

The chilly north winds are whistling through the trees, as witches gather ingredients for their brew and tune up their brooms. Ghosts and goblins are busy practicing tricks and planning for their biggest night of the year -- Halloween.

Everyone, from big clowns to little monsters, enjoys the festivities of Halloween. The big decision of what to be takes weeks of thinking about and planning, and a couple of hours at the last minute throwing a costume together.

Halloween parties are always fun. It's fun to dress in a disguise so that nobody knows who you are, and once they guess your identity you can still play the part of another character. Then there's the fun and games of bobbing for apples.

The climax of Halloween is sitting up all night with a tummy ache because you had to sample one of each in the trick or treat collection. I can remember going from door to door as a little kid, with my bag of goodies in one hand and a bar of soap in the other. I wasn't quite sure what I was supposed to do with the soap, but I knew you couldn't go trick or treating without it. I remember the lady down the street who always handed out homemade orange popcorn balls. It was an insult to get an apple (unless it was a caramel apple). All an apple did was make the bag heavier and crush all the good stuff.

Halloween wouldn't be complete without pumpkins carved with toothless grins. It's a terrible feeling of panic to drive all over town the day before Halloween trying to find a store that hasn't sold out of pumpkins. This year I solved that problem by growing my own. To everyone who said we couldn't do it, I would like to report that we have harvested more than two dozen perfectly shaped pumpkins and that's not counting the big one someone walked off with.

Though the wind may blow and the rain (or snow) might fall, move over Charlie Brown I'll join you in the pumpkin patch waiting for the great pumpkin. This could be the year he decides to make an appearance.

Becky Blossom of Canton won a bicycle of her choice in the Plymouth Canton Junior Football Association raffle drawing held Oct. 15. L. Nedeljkovick won a Detroit Lions autographed football, and Woody Seymour of Canton won a Detroit Lions wall plaque.

Jacqueline Wojcik, a Plymouth-Canton Lions cheerleader, sold the winning ticket and was awarded a \$20 gift certificate. Robby Rode, a Plymouth-Canton Steelers Varsity player, sold the greatest number of raffle tickets and was awarded a \$50 prize.

PLYMOUTH-NORTHVILLE JAYCEES 1980

## HAUNTED HOUSE

Location - Wayne County Child Development Center  
16300 Sheldon Rd - North of 5 Mile

Dates - Now through October 31st

Times - Mon-Fri: 7 pm-10:30 pm

Sat 6 pm-11 pm;

Sun 6 pm-10 pm

Children **\$100**

Adults **\$200**



# CASH REWARD

We pay more than any  
Old Shop in Town &  
we are Courteous also.

**-4 Big Days-**

Prices subject  
to daily market

REDFORD COIN  
GALLERIES  
25904 6 MILE  
1 BLK. W. OF BEECH  
DALY ON NORTH SIDE  
REDFORD TOWNSHIP  
DAILY 10-6 SAT. 10-4  
Closed Sunday  
255-9660

Plymouth  
Coin Galleries  
459-6655  
640 Starkweather

INVESTMENT JEWELRY  
& PRECIOUS METALS  
6848 ALLEN RD.  
(Ecorse Rd.)  
3 Blocks W. of Southfield  
ALLEN PARK  
388-5100

WE PAY **\$450,000**

& MORE FOR CERTAIN EXTREMELY RARE COINS -  
1870s HALF-DIME, 1804 DOLLAR

## GOLD & SILVER WANTED

WE CONTINUE TO PAY MORE

- We also check your coins for better dates and pay accordingly. We are professional Numismatists and not just scrap dealers like so many others.

THANK YOU, JIM

Gas Allowance  
ON ANY SALE TO US OVER \$500.00 We will  
pay 10¢ per mile Driven!! Max \$5.00

Top Dollar  
Pocket Watches  
Wanted



**PAYING CASH  
FOR ANY  
FORM OF GOLD**

Anything marked 10K -  
14K - 18K - BROKEN  
Rings - Bracelets - Jew-  
elry - Chains - Watches -  
Bullion - Nuggets -  
Placer, Etc.

10K • 14K  
18K  
Dental Gold

TOP  
DOLLAR  
PAID

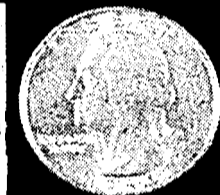

**U.S. SILVER  
COINS**

(1964 & Before)  
Paying

Buy  
\$6.00 to \$8.00  
\$3.00 to \$4.00  
\$1.20 to \$1.60

Half Dollars  
Quarters  
Dimes

**Kennedy  
Half**

1965  
\$2.20 to \$3.00  
each  
1970D - \$35.00

**Nickels**

1883 thru 1912 .20¢ ea.  
1913 thru 1938 .10¢ ea.  
1942 thru 1945 (with Lg. Mint  
mark above Dome) .65 to \$1.00 ea.  
Indian Head Foreign Coins  
Pennies 25¢ ea .3¢ ea.

Paying **\$14 to \$20**

Each and More for Silver Dollars

Minted  
Before  
1935

**MUST BE  
V.G. OR  
BETTER**

Top Dollar  
Paid for

All Rare Coins  
1893-S Dollar  
Pay \$605.00  
SMALL & LARGE  
QUANTITIES WANTED - NO  
APPOINTMENT NECESSARY

## DIAMONDS WANTED



Your unwanted stones  
could be worth hundreds  
to thousands of dollars.

**STERLING SILVER**

Sterling Flatware, Sterling Silver  
& Other Sterling Items



**Franklin Mint  
Sterling**

Especially wanted  
Franklin Mint,  
Danbury Mint - 1  
or bars.

**\$14.00 to \$31.00 per ounce**

Buying Canadian Silver  
Coins Minted Before 1967  
Pay 8 to 11 times face

## Plymouth Coin Galleries

640 Starkweather Old Village 459-6655

Next to Dave's Carpet Service

Hours-Daily 10:30-5 pm

Sat. 11-3

Closed Sun. & Tues.

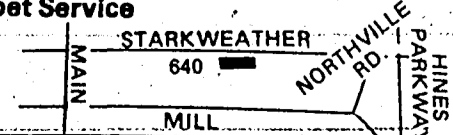



# Stride Rite® Scoots® give bad weather the boot.

Stride Rite® Scoots® boots keep growing feet high and dry. Scoots are durable, salt-resistant, fully lined and easy to clean. They'll give your children's feet all the protection they'll need this winter. Scoot on by and pick up a pair.



**KOBECK'S  
Stride Rite Bootery**



459-1070

1440 S. Sheldon, Plymouth

Hours: 9:30 to 5:30  
Fri. till 8:30

## what's happening

To list your group's event in "What's Happening" merely send the information (in writing) to: THE COMMUNITY CRIER, 1226 S. Main St., Plymouth, Mich. 48170. Information received by NOON MONDAY will be used in that Wednesday's paper (space permitting.)

### SYMPHONY LEAGUE BALL

The Plymouth Symphony League Silver Anniversary Ball will be held Dec. 6 at the Mayflower Meeting House, beginning at 8 p.m. All tables will accommodate 10 persons. Tickets are \$35 and go on sale Nov. 5, and can be purchased, cash only, from Jean Neuhardt, 9114 Muirland, Plymouth, 459-5426 or Linda Gasparott, 453-1905. There is a limited number of available tickets.

### FIEGEL BAZAAR

Fiegel School's Annual PTO Christmas Bazaar will be held Dec. 6. To rent craft tables, or for more information, call Rebecca Vodden at 455-4413.

### SIGMA KAPPA ALUMNAE MEETING

Sigma Kappa sorority alumnae of Western Wayne County will meet Nov. 3 at 8 p.m. at 7755 Capri Dr., Canton. Learn to cross stitch a Christmas ornament. RSVP to Mrs. Barbara Washenko, 459-1195.

### PANCAKE BREAKFAST

The Ladies Auxiliary to Mayflower Post 6695 V.F.W. will hold a pancake breakfast on Nov. 2. Pancakes, eggs, french toast, and sausage will be served from 8 a.m. to 1 p.m. at the Post Home located at 1426 S. Mill St. Cost is \$2. Everyone is welcome.

### RACQUETBALL LESSONS

Canton's Parks and Recreation Department is sponsoring beginning racquetball lessons, starting Nov. 3 at Rose Shores of Canton Racquetball Club. Lessons are from 10 a.m. to 11 a.m. every Monday for five weeks. Classes are limited. Cost is \$20. Register by person or mail to: Canton Township Parks and Recreation, 1150 South Canton Center. For more information, call 397-1000.

### CANTON NEWCOMERS CRAFT AUCTION

Canton Newcomers general membership meeting and craft auction will be held Nov. 5 at Pioneer Middle School at 7 p.m. All area residents are invited to attend. For more information or transportation, call Claudette at 455-5023.

### THREE CITIES ART CLUB

Three Cities Art Club is holding a general meeting on Nov. 5 at 8 p.m. at the PCAC office, 132 Main St. Wildlife artist Cathy McClung will give a demonstration on her painting techniques. The public is invited.

### PLYMOUTH WOMAN'S CLUB MEETING

The Woman's Club of Plymouth will hold a meeting on Nov. 7 at 7:30 p.m. at St. John's Episcopal Church. The Urquhart family will present a musical program.

### BAKE SALE

Miller School's PTO will sponsor a bake sale including coffee, tea, donuts and more on Election Day, Nov. 4 from 7 a.m. to 8 p.m. on the lawn of the school, 43721 Hanford Rd. in Canton.

### PLYMOUTH SOCCER CUP

Plymouth's Parks and Rec Soccer Cup for the under-12 boys division will be held at East and Central Middle Schools on Nov. 1 and 2. Quarter-final games are at 1 and 3 p.m. on Nov. 1 and semi-final games are at noon on Nov. 2 at both schools. The championship final is at 3:30 p.m. Nov. 2 at Central Middle School.

### CHRISTMAS BAZAAR

St. Kenneth's Christmas Bazaar will be held Nov. 8 from 10 a.m. to 6 p.m. and on Nov. 9 from 9 a.m. to 2 p.m. at the church, located at 14951 Haggerty Rd. south of 5 Mile.

### PIONEER PTSA

Pioneer's Parent-Teacher-Student Association will meet Oct. 29 at 7:30 p.m. in Pioneer's L.R.C.

### RACQUETBALL LEAGUES

Canton's Parks and Recreation Department is sponsoring racquetball leagues for women beginning Dec. 2 and for men beginning Dec. 3, at 8 or 8:30 p.m. at Rose Shores of Canton on Ford Road. Cost is \$60. Registration begins Nov. 3 in person or by mail to Canton Parks and Recreation, 1150 S. Canton Center Rd. For more information, call 397-1000.

### THANKSGIVING PARTY

The annual Thanksgiving Party for Canton kids ages 3 to 12 will be held Nov. 22 from 10 to 11:15 a.m. at the Canton Recreation Center on Michigan Ave. at Sheldon, sponsored by the Canton Recreation Department. Call the Recreation office at 397-1000 two weeks in advance for reservations.

### HYPNOSIS AND ESP

Schoolcraft College, Student Activities presents an evening of ESP and Hypnosis starring Ken Weber, Friday, Nov. 7, at 8 p.m. at the Schoolcraft College, Waterman Campus Office. Tickets are \$2.50 general admission and are available at the College Student Activities Office, and at the door. Schoolcraft College is located at 18600 Haggerty Rd. between 6 and 7 Mile in Livonia. For further information, call 591-6400, ext. 380.

### BRAILLE TRANSCRIBERS NEEDED

Braille transcribers are needed to learn to make books for the blind. The books are given to the blind throughout the Plymouth-Canton area as well as throughout the country. For more information, call 464-7378. Classes are held at the Carl Sandburg Library, Livonia, phone, 476-0700.

### CRAFT FAIR

Divine Savior Church, 39375 Joy between Haggerty and Newburg, will hold a craft air featuring more than 50 exhibitors as well as a bake sale and raffle on Nov. 8 from 9 a.m. to 3:30 p.m.

### BEGINNING RACQUETBALL

Canton Township's Parks and Recreation Department is sponsoring beginners' racquetball lessons on Mondays from 10 to 11 a.m. for 5 weeks beginning Nov. 3 at Rose Shores of Canton Racquetball Club on Ford Rd. Limit is 12 persons. Cost is \$20 per person. Register in person or by mail to Canton Parks and Recreation, 1150 S. Canton Center Rd., 48188. For more information, call 397-1000.

### PUNT, PASS & KICK

Canton's Parks and Recreation Department is sponsoring the first annual Punt, Pass and Kick competition for boys and girls on Nov. 1 at 10 a.m. at Griffin Park. Participants will be divided into age groups. Registration will be at Griffin Park at 9 a.m. on Nov. 1. For more information, call the Recreation Department at 397-1000.

### 'YOU'RE A GOOD MAN, CHARLIE BROWN'

The Plymouth Theatre Guild will present the musical comedy "You're A Good Man, Charlie Brown" by Clark Gesner based on the comic strip "Peanuts" by Schulz, on Nov. 7, 8, 14 and 15 at 8 p.m. in Central Middle School on Church and Main in Plymouth. The show is directed by Patricia Bray. Tickets are \$4 - adults; \$3 - students (under 18) and Senior Citizens; and may be purchased at the door on the night of performance or by phone at 420-2161 or 261-2875.



# STAN'S

38000 Ann Arbor Rd.

464-0330

**STORE HOURS**  
MONDAY THRU SATURDAY  
9 A.M. to 9 P.M.  
SUNDAY  
10 A.M. to 5 P.M.

QUANTITY  
RIGHTS RESERVED  
PRICES GOOD THRU  
Nov. 2, 1980

NOW OPEN: Stan's Discount Produce and Stan's  
Discount Beverage Centers!

USDA CHOICE

**SIRLOIN STEAK**

**\$2.78**  
lb.

LEAN, MEATY

**PORK STEAK**

**\$1.18**  
lb.

**FREEZER BEEF**

USDA CHOICE

**BEEF SIDES**

**\$1.49**

USDA CHOICE

**HIND  
QUARTERS**

**\$1.69**

Cut and wrapped the way you like.

**BEEF is going higher! Order now so we can guarantee  
these prices to you.**

# what's happening

To list your group's event in "What's Happening" merely send the information (in writing) to: THE COMMUNITY CRIER, 1226 S. Main St., Plymouth, Mich. 48170. Information received by NOON MONDAY will be used in that Wednesday's paper (space permitting.)

## FIRST THANKSGIVING

The Plymouth Newcomers will host a recreation of the first Thanksgiving on Nov. 6 at 11:30 a.m. in the Mayflower Meeting House. For reservations, which must be made by Nov. 4 call Doreen Myernick at 455-1843.

## COSTUME AND PUMPKIN CARVING

Plymouth's Parks and Recreation Department is sponsoring its annual Halloween Costume and Pumpkin Carving Contest for kids 12 years and under on Oct. 30 at 4 p.m. at the Cultural Center, 525 Farmer. Participants in the costume contest have free admission for open ice skating between 3 and 5:30 p.m. Prizes will be awarded for best costumes and pumpkins. For more information, call 455-6620.

## SENIOR IN-HOME SERVICES

In-Home services will be offered to senior citizens over 60 years who reside in Plymouth, Plymouth Township, Northville and Northville Township sponsored by the Out-Wayne County Area Agency on Aging. To receive services, or for more information, call Traci Johnson at 455-6627.

## MAKE IT AND TAKE IT

The Plymouth Community Arts Council will sponsor a "Make it and Take it" basket workshop Saturday, Nov. 8 from 10 a.m. to 2 p.m. Cost is \$6.50, with a kit price of \$4. For more information, call the PCAC at 455-5260 between 9 a.m. and noon.

## MASTERPIECE AUCTION

The Plymouth Children's Co-op Nursery is sponsoring a Masterpiece Auction on Nov. 3 at 6:30 p.m. at East Middle School. Open to the public, the auction will feature all hand-made Christmas items. Refreshments will be served.

## AFTER SCHOOL DAY CAMP

The Plymouth Community Family Y is sponsoring a year-round after school day camp at Starkweather School Monday through Friday from 3:45 to 5:45 for grades 1 to 5. Cost is \$8 for members, \$10 for non-members. Transportation is available for an additional \$1 per week. Register one week prior to attendance by calling 453-2904.

## SCHOOLCRAFT PLAYERS

Schoolcraft College Players will present Neil Simon's comedy "Come Blow Your Horn" on its 20th anniversary for the school's Fall Dinner Theater production on Nov. 14, 15, 21 and 22. Dinner will be served at 6:30 p.m., followed by the performance at 8 p.m. Tickets are \$10 per person, available at the college bookstore. For more information, call 591-6400, ext. 265.

## BATON LESSONS

The Plymouth Family YMCA is sponsoring baton lessons for children in the first to fifth grades, for six weeks beginning Nov. 10, at Smith School on Mondays from 3:15 to 4:15 p.m., Tanger School on Wednesdays from 3:45 to 4:45 p.m., and Bird School on Thursdays from 4 to 5 p.m. Cost is \$12 for members, \$15 non-members. Baton not provided. For more information, call 453-2904.

## FIELD TRIP

Canton's Park and Recreation Department is sponsoring a field trip to the Henry Ford Museum at Greenfield Village for Trace "C" students on Nov. 18. Children will leave from the Township Administration Building at 10:30 a.m. and return at approximately 1:30 p.m. Cost is \$2.50. Register at the Recreation office, 1150 S. Canton Center Rd.

## ABRA-CA-DABRA

A magic show and workshop for second graders and up will be held Oct. 30 at 4 p.m. at the Dunning-Hough Library, featuring The Great Sterlini. Participants will need to bring a deck of cards, pencil, handkerchief, paper napkin and quarter.

## MILLIONAIRES PARTY

Canton Newcomers will sponsor a Millionaires Party Nov. 8 from 8 p.m. to 1 a.m. at the Plymouth Cultural Center, 525 Farmer. Cost is \$20 per couple. Reservation deadline is Nov. 5. For information or reservations, call Debbie Barnes at 981-1520.

## NATURAL FOODS AND NUTRITION

The Childbirth and Family Resource Center is offering a nutrition and natural foods workshop for parents of pre-school children on Nov. 1 from 10 a.m. to 12:30 p.m. Fee is \$10. For more information, call 455-0966 or 459-2360.

## GORGEOUS GEORGE

"Gorgeous George" Grant, former professional wrestler, now an evangelist, will preach at the Salem Bible Church, 9481 W. Six Mile Rd. in Salem, from Oct. 26 to 30. Sermons will be held Oct. 26 at 10 and 11 a.m. and at 7 p.m., and from Oct. 27 to 30 at 7:30 p.m.

## LIONS

The Lion's Club of Plymouth will hold its regular meeting Nov. 6 at 6:30 p.m. at the Mayflower Hotel. District Governor John Cioroch will visit officially.

## CANTON CRAFT FAIR

The Canton Craft Fair, sponsored by the Canton Jayettes, will be held Nov. 22 at the Canton High School cafeteria. There will be 60 tables of crafts, open from 9:30 a.m. to 5 p.m. Admission is free.

## OPEN RECREATIONAL SWIM

Open recreational swim will be held at Central Middle School pool from 7:30 to 9 p.m. Monday and Wednesday evenings, and at Canton High School pool from 3 to 4 p.m. and family swim from 4 to 5 p.m. Cost is 50 cents for students, 75 cents for adults and a maximum of \$1.50 for Canton High's family swim.

## CHRISTMAS BOUTIQUE

The First United Methodist Church will hold its annual Christmas Boutique Nov. 14 from 9:30 a.m. to 5 p.m. at the church, 45201 N. Territorial. Exhibitors will display wares, and the ladies of the church will serve lunch.

## PLYMOUTH TOPS CLUB

The Plymouth 238 TOPS (Take Off Weight Sensibly) Club meets on Wednesdays at 7 p.m. at the Plymouth Grange. New members are welcome. For more information, call Barb at 455-5813.

## SOROPTIMIST

A President's Council meeting of Soroptimist International, of the Americas, Inc. will be held Nov. 19 at 6:30 p.m. in the Miles Standish Room of the Mayflower Hotel in Plymouth.



## BUSY BEE CRAFTS

845 N. Mill  
new location (in Old Village)  
455-8560

Hours: Mon.-Thurs 10 a.m.-9 p.m.  
Fri. 10-6 p.m.  
Sat. 10-5

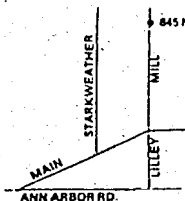

## BEGINNING SILK FLOWERS

3 Weeks \$9.00 plus supplies  
Thurs. Oct. 30, 7-9 p.m.  
Wed. Nov. 5, 10-12 noon  
Mon. Nov. 10, 7-9 p.m.

## FLOWER ARRANGING CLASS (Bridal too)

3 weeks \$9.00 plus supplies  
Sat. Nov. 1, 3-5 p.m.  
Tues. Nov. 11 1-3 p.m.

## CANING

Sat. Nov. 15, 2-4:30 p.m.

## 44 STITCH NEEDLEPOINT

Wed. Nov. 5, 7-9 p.m.

## COUNTED CROSS STITCH

Tues. Nov. 4, 7-9 p.m.  
Fri. Nov. 7, 10-12 noon  
Tues. Nov. 25, 7-9 p.m.

## DIP 'N DRAPE DOLLS

2 weeks \$6.00 plus supplies  
Wed. Nov. 5, 1-3 p.m.  
Thurs. Nov. 20, 10-12 noon

## CREWEL

4 weeks \$12.00 plus supplies  
Thurs. Nov. 6, 10-12 noon  
Mon. Nov. 10, 7-9 p.m.

## WHEAT WEAVING

1 session \$3.00 plus supplies  
Mon. Nov. 3, 1-3 p.m.  
Fri. Nov. 7, 10-12 noon  
Tues. Nov. 11, 7-9 p.m.  
Wed. Nov. 12, 7-9 p.m.  
Fri. Nov. 14, 1-3 p.m.  
Tues. Nov. 18, 1-3 p.m.  
Tues. Nov. 18, 7-9 p.m.  
Thurs. Nov. 20, 10-12 noon

## QUILLERY

3 weeks \$9.00 plus supplies  
Thurs. Nov. 6, 1-3 p.m.

## PINECONE WREATH

1 session \$3.00 plus supplies  
Tues. Nov. 4, 10-12 noon  
Thurs. Nov. 20, 7-9 p.m.

## FORMAL CHRISTMAS ARRANGEMENT

1 session \$3.00 plus supplies  
Thurs. Nov. 6, 1-3 p.m.  
Tues. Nov. 11, 7-9 p.m.  
Sat. Nov. 22, 12-2 p.m.

## CHRISTMAS BROOM

1 session \$3.00 plus supplies  
Thurs. Nov. 13, 1-3 p.m.  
Wed. Nov. 19, 10-12 noon  
Thurs. Nov. 20, 10-12 noon

## CRAFTS FOR KIDS Adults Only

2 weeks \$10.00 plus supplies  
Sat. Nov. 1, 10-1 p.m.

## QUILTING

4 weeks \$12.00 plus supplies  
to make a pillow  
6 weeks \$18.00 plus supplies  
to make a full quilt  
Mon. Nov. 17, 7-9 p.m.  
Mon. Nov. 17, 1-3 p.m.

## HOUSE KLEENEX COVER

1 session \$3.00 plus supplies  
Tues. Nov. 4, 7-9 p.m.  
Wed. Nov. 5, 10-12 noon  
Wed. Nov. 12, 1-3 p.m.  
Wed. Nov. 19, 7-9 p.m.  
Tues. Nov. 25, 7-9 p.m.  
Wed. Nov. 26, 1-3 p.m.

## FABRIC WREATH

1 session \$3.00 plus supplies  
Wed. Nov. 5, 1-3 p.m.  
Wed. Nov. 19, 1-3 p.m.  
Wed. Nov. 26, 7-9 p.m.

## MACRAME AND

## BASKETWEAVING

5 weeks \$15.00 plus supplies  
Tues. Nov. 11 10-12 noon  
Wed. Nov. 12 10-12 noon

## SNOWMAN

1 session \$3.00 plus supplies  
Mon. Nov. 3, 10-12 noon  
Thurs. Nov. 6, 7-9 p.m.  
Sat. Nov. 8, 1-3 p.m.  
Mon. Nov. 10, 10-12 noon  
Thurs. Nov. 13, 10-12 noon  
Tues. Nov. 18, 7-9 p.m.  
Fri. Nov. 21, 1-3 p.m.  
Sat. Nov. 22, 10-12 noon

## SANTA MAT

1 session \$3.00 plus supplies  
Sat. Nov. 1, 1-3 p.m.  
Thurs. Nov. 13, 10-12 noon  
Tues. Nov. 25, 10-12 noon  
Sat. Nov. 22, 12-2 p.m.  
Wed. Nov. 26, 10-12 noon

## SWEET GRASS BASKET

2 sessions \$6.00 plus supplies  
Mon. Nov. 10, 1-3 p.m.  
Mon. Nov. 10, 7-9 p.m.  
Mon. Dec. 1, 7-9 p.m.  
Mon. Dec. 1, 1-3 p.m.

## SILK FLOWER WREATH

2 sessions \$6.00 plus supplies  
Tues. Nov. 25, 7-9 p.m.  
Fri. Nov. 7, 1-3 p.m.

Register Now for November classes

# Canton voters will see these candidates

## CONGRESSIONAL

**REPRESENTATIVE IN CONGRESS**  
15th District  
VOTE FOR not more than ONE

Democratic	<b>WILLIAM D. FORD</b>	<b>35</b>
Republican	<b>GERALD R. CARLSON</b>	<b>36</b>
American Independent	<b>ALDI C. FUHRMANN</b>	<b>37</b>

## LEGISLATIVE

**REPRESENTATIVE IN STATE LEGISLATURE**  
37th District  
VOTE FOR not more than ONE

Democratic	<b>THOMAS H. BROWN</b>	<b>40</b>
------------	------------------------	-----------

## TOWNSHIP

**SUPERVISOR**  
VOTE FOR not more than ONE

Democratic	<b>NOEL D. CULBERT</b>	<b>106</b>
Republican	<b>JAMES E. POOLE</b>	<b>107</b>

**TOWNSHIP CLERK**  
VOTE FOR not more than ONE

Democratic	<b>JOHN W. FLODIN</b>	<b>109</b>
------------	-----------------------	------------

**TOWNSHIP TREASURER**  
VOTE FOR not more than ONE

Democratic	<b>MARIA FALKIEWICZ</b>	<b>112</b>
Republican	<b>JAMES W. KEARNEY</b>	<b>113</b>

**TRUSTEE**  
VOTE FOR not more than FOUR

Democratic	<b>CAROL A. BODENMILLER</b>	<b>118</b>
Democratic	<b>LARRY K. BOWERMAN</b>	<b>119</b>
Democratic	<b>MARY F. DINGELDEY</b>	<b>120</b>
Democratic	<b>GARY ROBERTS</b>	<b>121</b>
Republican	<b>LOREN N. BENNETT</b>	<b>122</b>
Republican	<b>DUANE D. BORDINE</b>	<b>123</b>
Republican	<b>STEPHEN K. LARSON</b>	<b>124</b>
Republican	<b>ROBERT M. PADGET</b>	<b>125</b>

**LIBRARY COMMISSIONER**  
VOTE FOR not more than SIX

Democratic	<b>MARY S. FELTZ</b>	<b>128</b>
Democratic	<b>DOUGLAS J. RITTER</b>	<b>129</b>
Democratic	<b>JOHN O. SCHWARTZ III</b>	<b>130</b>
Republican	<b>KATHERINE A. BALDRICA</b>	<b>131</b>
Republican	<b>JAMES GILLIG</b>	<b>132</b>
Republican	<b>NORMA JEAN WEST</b>	<b>133</b>

**DO IT NOW**  
ENROLL YOUR EAGER CHILD IN  
**HUGS & KISSES**  
CHILD CARE & LEARNING PRE-SCHOOL PROGRAM

Ages 2 1/2 - 9  
Certified Teachers  
Full time, Part-time, Drop-in, ESY  
Conveniently Located in a Storybook setting at  
104 N. Main, Plymouth  
459-5830



447 Forest  
453-4933

Open 365 days a year.  
Daily 7:30-10  
Sun. 8-10

**100% Naturally Flavored Ice Cream**

**MILK SALE**

Homo Two 1/2 gal. ctns. **\$1.89**      Lo-Fat plastic gal. **\$1.59**

Coke 10 oz. 6 pks. **\$1.39** plus deposit

**Feature of the Week**  
**30¢ Off**  
A Half Gallon of  
**Tin Roof**

Limit 1  
With this coupon thru Nov. 5th

# Here are Plymouth Twp. candidates

	DEMOCRATIC	REPUBLICAN	AMER. IND.	LIBERTARIAN
<b>CONGRESSIONAL</b> Representative in Congress 2nd District	Representative in Congress <b>KATHLEEN F. O'REILLY</b> 363	Representative in Congress <b>CARL D. PURSELL</b> 364	Representative in Congress <b>JOHN L. WAGNER</b> 365	Representative in Congress <b>JAMES L. HUDLER</b> 366
<b>LEGISLATIVE</b> Representative in State Legislature 52nd District	Representative in State Legislature <b>JUDITH F. THIEL</b> 445 Note: Small portion of Plymouth Twp. voters are in 37th State Rep. District. See Canton's list.	Representative in State Legislature <b>ROY SMITH</b> 446		
<b>TOWNSHIP</b> Supervisor	Supervisor <b>CAROL A. LEVITTE</b>	Supervisor <b>MAURICE M. BREEN</b>		
Township Clerk	Township Clerk	Township Clerk <b>ESTHER HULSING</b>		
Township Treasurer	Township Treasurer	Township Treasurer <b>JOSEPH WEST</b>		
Trustee	Trustee <b>F. PATRICK DOWNES</b>	Trustee <b>WEYONA LEE FIDGE</b>		
VOTE FOR not more than FOUR	Trustee <b>DONALD SKINNER</b>	Trustee <b>GERALD H. LAW</b>		
	Trustee	Trustee <b>BARBARA J. LYNCH</b>		
	Trustee	Trustee <b>ANDREW E. PRUNER</b>		
Constable	Constable	Constable <b>DONALD KING</b>		
VOTE FOR not more than TWO	Constable	Constable <b>FRANCIS E. EADWICK</b>		

**Fall Wallpaper Sale**  
extended thru November 15th

**15% off All Books**  
3 rolls or more of same pattern

**25% off Stock Wallpaper**

Close Out on  
**Unfinished Furniture**  
Shaker Items Not Included **25% off**

CUSTOM MIXING  
AT NO EXTRA CHARGE

**PEASE PAINT & WALLPAPER CO.**

570 S. Main Street      453-5100

Mon.-Fri., 9-9 pm  
Sat. 9-5 pm





# State, county proposals printed

## STATE PROPOSALS

**PROPOSAL A** A PROPOSAL TO MAKE LOCAL SCHOOL BOARDS RESPONSIBLE FOR SCHOOL PERSONNEL AND PROGRAMS, TO REDUCE LOCAL PROPERTY TAX MAXIMUMS FOR OPERATIONAL PURPOSES, TO PROVIDE ADDITIONAL PROPERTY TAX RELIEF FOR SENIOR RETIREES, AND REQUIRE THE STATE TO RAISE REVENUES NECESSARY FOR EQUAL PER-PUPIL FUNDING OF PUBLIC SCHOOLS.

- The proposed amendment would:
1. Make local school boards responsible for school personnel and programs.
  2. Reduce current maximum property tax for county, township and educational operations from 50 to 24.5 mills and allocate millage.
  3. Allow state 30.5 mill school property tax on non-homesteads.
  4. Eliminate property taxes on \$25,000.00 of home assessments of retirees 65 and older.
  5. Require general state taxation for equal per-pupil school financing at highest state support level.
  6. Limit local school tax to 7 mills or 1% income tax by vote of electors.
  7. Exclude additional school financing from other revenue and spending limits of constitution and require millage reduction by class.

Should this amendment be adopted?  
**YES 179 NO 180**

**PROPOSAL B** PROPOSAL TO REDUCE THE LEGAL DRINKING AGE.

The proposed amendment would reduce the legal drinking age from 21 to 19 years of age.

Should this amendment be adopted?  
**YES 182 NO 183**

**PROPOSAL C** PROPOSAL TO PROVIDE PROPERTY TAX RELIEF; TO REIMBURSE LOCAL AND STATE GOVERNMENTS WITH ADDITIONAL SALES TAX; TO MANDATE NET STATE LOTTERY REVENUE FOR SCHOOLS; AND TO MANDATE STATE "RAINY DAY" FUND.

- The proposed amendment would:
1. Eliminate property taxes on first \$7,100.00 of home assessments for school and government operations. The amount of this exemption will increase with future inflation.
  2. Eliminate sales tax on home use of electricity, gas and other heating fuels.
  3. Increase sales tax by 1.5 cents per dollar to reimburse state and local government and schools for lost tax revenues including new tax relief for renters.
  4. Mandate use of net state lottery revenues for schools.
  5. Mandate state "Rainy Day" fund.
  6. Modify existing constitutional requirements concerning state aid to local government and provide greater millage reductions.

Should this amendment be adopted?  
**YES 187 NO 188**

**PROPOSAL D** PROPOSAL TO DECREASE PROPERTY TAXES AND PROHIBIT NEW TYPES OF HOMESTEAD TAXES; TO REQUIRE 60% VOTER APPROVAL TO RAISE STATE TAXES OR FEES; TO REQUIRE PARTIAL STATE REIMBURSEMENT TO LOCAL UNITS FOR LOST INCOMES; TO LIMIT LEGISLATURE'S ABILITY TO CHANGE TAX EXEMPTIONS OR CREDITS OR CHANGE PER-PUPIL FORMULA.

- The proposed amendment would:
1. Prohibit new types of homestead taxes.
  2. Prohibit new or increased state taxes without 60% voter approval.
  3. Provide for taxation of property by class.
  4. Eliminate certain property tax exemptions.
  5. Reduce appraisal of all property to 25% of 1978 value; limit future residential and agricultural increases to 2% per year.
  6. Expand homestead tax reductions for low-income and seniors, including renters.
  7. Mandate additional state reimbursement to local governments for portion of lost revenue by possible reduction of some existing state services.
  8. Require 4/5 vote of legislature to reduce income tax exemptions or credits or change per-pupil formula.

Should the proposed amendment be adopted?  
**YES 194 NO 195**

**PROPOSAL E** PROPOSAL TO CONSTRUCT FOUR REGIONAL PRISON FACILITIES, DEMOLISH THE MICHIGAN REFORMATORY, EFFECT OTHER STATE AND LOCAL CORRECTIONAL PURPOSES, DEVELOP PREVENTIVE PROGRAMS, AND PROVIDE THE FUNDS THEREFOR BY INCREASING THE STATE INCOME TAX BY 1/10 OF 1% FOR 5 YEAR PERIOD.

- The proposed law provides for:
1. Construction of 4 new regional prison facilities.
  2. Demolition of Michigan Reformatory.
  3. Other state and local correctional purposes and preventive programs.
  4. Funding the foregoing with an increase in the state income tax by 1/10 of 1% for 5 years beginning in 1-1-81.

Should this law be adopted?  
**YES 197 NO 198**

**PROPOSAL G** A PROPOSAL TO ALLOW THE LEGISLATURE TO PASS LAWS RELATING TO THEIR CONSTITUTIONAL EXEMPTION FROM CIVIL ARREST DURING LEGISLATIVE SESSIONS.

1. The Michigan Constitution now provides: "Senators and representatives shall be privileged from civil arrest and civil process during sessions of the legislature and for five days next before the commencement and after the termination thereof. They shall not be questioned in any other place for any speech in either house."
2. The proposed amendment would allow the legislature to pass a law to modify this exemption.

Should this amendment be adopted?  
**YES 201 NO 202**

**PROPOSAL H** A PROPOSAL TO RESTRICT THE AUTHORITY OF THE LIEUTENANT GOVERNOR AND SET UP A PROCEDURE TO FILL A VACANCY IN THE OFFICE OF LIEUTENANT GOVERNOR.

- The proposed amendment would:
1. Allow an incumbent legislator to be eligible for appointment to the office of Lieutenant Governor.
  2. Eliminate provision making Lieutenant Governor President of the Senate with the right to break tie vote.
  3. Allow the Governor to appoint to fill a vacancy in the office of Lieutenant Governor, subject to the approval of the appointment by majority vote of both houses of the legislature.

Should this amendment be adopted?  
**YES 205 NO 206**

## WAYNE COUNTY PROPOSALS

**PROPOSAL J** ADOPTION OF SEPARATE TAX LIMITATIONS.

Shall separate tax limitations be established for an indefinite period, or until altered by the voters of the County, for the County of Wayne and the townships and school districts within the County, the aggregate of which shall not exceed 18 mills, as follows:

County of Wayne .....	7.27 Mills
Townships .....	1.10 Mills
Intermediate School Districts .....	.13 Mills
School Districts (a school district located entirely within a city or charter township shall receive in addition millage equal to the township millage; in addition, a school district located entirely outside a community college district provided for under section 81 of Act No. 331 of the Public Acts of 1966 being section 389.81 of the Michigan Compiled Laws, shall receive millage equal to the millage provided for that community college district under section 11 of Act No. 62 of the Public Acts of 1933, as amended, being section 211.211 of the Michigan Compiled Laws).....	9.25 Mills
Wayne County Community College .....	.25 Mills
Total .....	18.00 Mills

**YES 214 NO 215**

**PROPOSAL K** TAX RATE LIMITATION INCREASE PROPOSITION FOR WAYNE COUNTY GENERAL HOSPITAL, AND MEDICAL CARE FOR THE INDIGENT.

Shall the County of Wayne increase the millage as provided in Article IX, Section 6 of the Michigan State Constitution and levy an additional .5 of a mill for a period of five years, from 1981 through 1985 (\$.50 per thousand dollars of State equalized valuation) the proceeds to be used for the purpose of supporting and maintaining the statutorily mandated hospital care of financially distressed citizens of Wayne County and for the operation and maintenance of Wayne County General Hospital?

**YES 217 NO 218**

**PROPOSAL L** TAX RATE LIMITATION INCREASE PROPOSITION FOR MENTAL HEALTH CARE SERVICES.

Shall the County of Wayne increase the millage as provided in Article IX, Section 6 of the Michigan State Constitution and levy an additional .5 of a mill for a period of five years, from 1981 through 1985 (\$.50 per thousand dollars of State equalized valuation) the proceeds to be used for the purpose of defraying County obligations for the statutorily mandated mental health care services for the Citizens of the County of Wayne?

**YES 220 NO 221**

**PROPOSAL M** TAX RATE LIMITATION INCREASE PROPOSITION FOR WAYNE COUNTY SHERIFF AND PROSECUTING ATTORNEY.

Shall the County of Wayne increase the millage as provided in Article IX, Section 6 of the Michigan State Constitution and levy an additional .5 of a mill for a period of five years, from 1981 through 1985 (\$.50 per thousand dollars of State equalized valuation) the proceeds to be used for the purpose of supporting and maintaining the operations of the Wayne County Sheriff and Prosecuting Attorney?

**YES 223 NO 224**

**Laurel**  
 FURNITURE

**DIRECTOR'S CHAIR**  
 The Price  
**\$21<sup>88</sup>**



100% Polyester vat-dyed fabric. White baked enamel steel frames. 3 colors

584 Ann Arbor Trail  
 Plymouth 453-4700  
 Open Daily 9:30-6 pm  
 Thurs. & Fri. til 9:00 pm



IN OLD VILLAGE ITS  
**Bill's Market**

584 Starkweather  
 Plymouth 453-5040

**Beer & Wine to Take Out**  
**Groceries • Party Snacks**  
 • Meats • Sandwiches  
 • Delicatessen



**DIFFERENT STROKES FOR DIFFERENT FOLKS**  
 Dogs have differing nutritional requirements. They vary with each life cycle and life style. Science Diet Dog Food... meet these requirements with four specific, precisely balanced formulas...

- Growth For puppies
- Lactation For pregnant or lactating females
- Maintenance For adult dogs
- Maximum stress For highly stressed/working dogs

Each diet offers proper nutrition, high digestibility, low stool volume and consistent ingredients.

For a healthier, happier dog... see us for assistance with your total pet care program.

**SAXTONS GARDEN center inc.**



587 W. ANN ARBOR TRAIL  
 PLYMOUTH • 453-6250

# Here's portion of ballot all local voters will face

## PRESIDENTIAL

### ELECTORS OF PRESIDENT AND VICE-PRESIDENT OF THE UNITED STATES VOTE FOR not more than ONE

Democratic	JIMMY CARTER WALTER F. MONDALE	23
Republican	RONALD REAGAN GEORGE BUSH	25
Libertarian	ED CLARK DAVID KOCH	27
Citizens	BARRY COMMONER LaDONNA HARRIS	29
Anderson Coalition	JOHN B. ANDERSON PATRICK J. LUCEY	31
Independent Candidate	GUS HALL ANGELA Y. DAVIS	33

## COUNTY

### COUNTY CLERK VOTE FOR not more than ONE

Democratic	JAMES R. KILLEEN	86
------------	------------------	----

### COUNTY TREASURER VOTE FOR not more than ONE

Democratic	RAYMOND J. WOJTOWICZ	88
------------	----------------------	----

### REGISTER OF DEEDS VOTE FOR not more than ONE

Democratic	FOREST E. YOUNGBLOOD	90
------------	----------------------	----

### DRAIN COMMISSIONER VOTE FOR not more than ONE

Democratic	CHARLES N. YOUNGBLOOD	92
Republican	GEORGE H. CULLY	93

### COUNTY AUDITOR VOTE FOR not more than ONE

Democratic	RICHARD T. KELLY	95
------------	------------------	----

### COUNTY COMMISSIONER 27th District VOTE FOR not more than ONE

Democratic	R. WILLIAM JOYNER	98
Republican	DARRELL F. KRESS	99

### CHARTER COMMISSIONER 27th District VOTE FOR not more than ONE

Democratic	WALTER T. HINK	101
Republican	HAGBARD J. BERG	102

### SHERIFF VOTE FOR not more than ONE

Democratic	WILLIAM LUCAS	81
Republican	J. VIDA	82
American Independent	HECTOR M. MCGREGOR	83
Libertarian	PHILIP B. LIPSON	84

## COUNTY

### PROSECUTING ATTORNEY VOTE FOR not more than ONE

Democratic	WILLIAM L. CAHALAN	79
------------	--------------------	----

## STATE BOARDS

### MEMBERS OF THE STATE BOARD OF EDUCATION VOTE FOR not more than TWO

Democratic	CARROLL M. HUTTON	43
Democratic	JAMES H. LINCOLN	44
Republican	NORMAN STOCKMEYER	45
Republican	EDMUND VANDETTE	46
American Independent	WALTER B. DYER	47
American Independent	DANIEL R. ELLER	48
Libertarian	SCOTT JAMES BALLARD	49
Libertarian	CHRISTINE YOUNG	50

### MEMBERS OF THE BOARD OF REGENTS OF THE UNIVERSITY OF MICHIGAN VOTE FOR not more than TWO

Democratic	STUART E. HERTZBERG	51
Democratic	NELLIE M. VARNER	52
Republican	DEANE BAKER	53
Republican	DAVID LARO	54
American Independent	RALPH W. HUGHEY	55
American Independent	GERALDINE A. SANTUCI	56
Libertarian	CLAUDIA C. DECHOW	57
Libertarian	KURT A. O'KEEFE	58

### MEMBERS OF THE BOARD OF TRUSTEES OF MICHIGAN STATE UNIVERSITY VOTE FOR not more than TWO

Democratic	WILLIAM D. BYRUM	60
Democratic	ELIZABETH P. HOWE	61
Republican	PAUL GADOLA	62
Republican	THOMAS REED	63
American Independent	WILBUR E. MILLER	64
American Independent	TRUMAN T. SHORE	65
Libertarian	JAMES E. HURRELL	66
Libertarian	CHARLES SEVERANCE	67

### MEMBERS OF THE BOARD OF GOVERNORS OF WAYNE STATE UNIVERSITY VOTE FOR not more than TWO

Democratic	MURRAY E. JACKSON	69
Democratic	ELENA R. SANCHEZ	70
Republican	KURT R. KEYDEL	71
Republican	RICHARD VAN DUSEN	72
American Independent	E. FORREST CHAPMAN	73
American Independent	JOHN P. SANTUCI, JR.	74
Libertarian	DENISE KLINE	75
Libertarian	MARILYN J. SLOAN	76

## NON-PARTISAN BALLOT

### JUSTICES OF THE SUPREME COURT (Full Term) (Term Ending January 1, 1989) VOTE FOR not more than TWO

MICHAEL K. HEGARTY	139
CHARLES L. LEVIN JUSTICE OF THE SUPREME COURT	140
JOSEPH B. SULLIVAN	141
ELIZABETH BURCH	137
MARY S. COLEMAN JUSTICE OF THE SUPREME COURT	138

### JUDGES OF COURT OF APPEALS FIRST DISTRICT (Full Term) (Term Ending January 1, 1987) VOTE FOR not more than TWO

VINCENT J. BRENNAN JUDGE OF COURT OF APPEALS	144
GEORGE N. BASHARA, JR. JUDGE OF COURT OF APPEALS	143

### JUDGES OF THE CIRCUIT COURT THIRD JUDICIAL CIRCUIT (Full Term) (Term Ending January 1, 1987) VOTE FOR not more than EIGHT

PETER B. SPIVAK JUDGE OF CIRCUIT COURT	153
VICTOR J. BAUM JUDGE OF CIRCUIT COURT	146
RICHARD D. DUNN JUDGE OF CIRCUIT COURT	147
HAROLD HOOD JUDGE OF CIRCUIT COURT	148
CHARLES KAUFMAN JUDGE OF CIRCUIT COURT	149
JOHN R. KIRWAN JUDGE OF CIRCUIT COURT	150
JOHN D. O'HAIR JUDGE OF CIRCUIT COURT	151
THOMAS ROUMELL JUDGE OF CIRCUIT COURT	152

### JUDGES OF THE CIRCUIT COURT THIRD JUDICIAL CIRCUIT (Full Term) (Term Ending January 1, 1987) VOTE FOR not more than THREE

WILLIAM C. HAGUE	158
RICHARD C. KAUFMAN	159
PATRICK J. McDONALD	160
HENRY J. SZYMANSKI	161
LUCILE A. WATTS	162
MARIANNE O. BATTANI	157

### JUDGES OF PROBATE (Full Term) (Term Ending January 1, 1987) VOTE FOR not more than TWO

THOMAS A. MAHER JUDGE OF PROBATE	164
Y. GLADYS BARSAMIAN JUDGE OF PROBATE	163

Serving  
**PLYMOUTH-CANTON**  
COMPLETE OFFSET  
PRINTING SERVICE  
featuring 3M 412 CAMERA  
Call  
453-6770  
**Pilgrim Printer**  
432 S. Main Plymouth

*Geneva's  
of Plymouth*  
Bridal Shoppe  
NOW OPEN THURS. & FRI.  
EVENINGS UNTIL 9 p.m.  
Mon.-Tues.-Wed.-Sat. 10-8  
417 Forest Place 455-4445

What weighs 310 lbs; gives you  
heat and light, and is related to  
your Corningware coffeepot?  
Call  
**Village Fireplace**  
459-3120  
and Find Out!

# Fund drive going strong

The 1981 Plymouth Community Fund Drive had collected \$75,828 by Friday, Roger Haslick, fund spokesperson, announced.

"We're very encouraged by the number of businesses and service groups that have responded," he said.

The fund drive will continue throughout the month of October. Its goal is \$318,000. The money is used to support charitable and non-profit organizations in Plymouth such as the Plymouth Dental Fund, Opportunity House, and the Girl and Boy Scouts.

1981 goal:  
\$318,000

\$75,828



## Schools to close

To make elections on Tuesday, Nov. 4 run smoothly, Plymouth-Canton schools will close for at least part of the day. Students on a traditional school calendar will have the day off.

Students of extended school year calendars will attend school in the morning. Pioneer students will be released at 10:25 a.m.; Isbister and Eriksson students will go home at 11:15 a.m.; and kids at Field, Gallimore, Hulsing, and Miller schools can go home at 11:30 a.m.

## Canton election

Cont. from pg. 1

Supervisor Noel Culbert forsees "a record turnout" this year at the polls.

Campaigning for township supervisor are incumbent Democrat Noel Culbert and Republican James Poole. Culbert, who served during one of the township's greatest growth periods, will seek to retain his position against Poole, a former trustee and vocal critic of many township policies.

John Flodin, township clerk, runs unopposed this year.

The race for treasurer will pit Deputy Treasurer Maria Falkiewicz against challenger James Kearney, a Republican. Falkiewicz, a Democrat, has worked full-time in the treasurer's office since Treasurer James Donahue stepped down several months ago. Kearney cites an extensive background in finance as qualifications for his bid for office.

Trustee hopefuls include Democrats Carol Bodenmiller, an incumbent, Larry Bowerman, Mary Dingeldey, and Gary Roberts. Republican candidates include Loren Bennett, Duane Bordine, incumbent Stephen Larson and Robert Padget.

Possibly the best-qualified slate of trustee candidates in several years, the elected board will oversee township administration through an important period during the next four years.

Library Commission candidates include Democrats Mary Feltz, Douglas Ritter, John O. Schwartz, III, and Republicans Katherine Baldrice, James Gillig and Norma Jean West. Canton's library, located on the third floor of the township Administration Building, recently opened and is still in the process of "settling in."

Several county races are also of interest to Canton voters. County Commissioner incumbent William Joyner, a Democrat, will defend his seat on the commission from Republican Darrell F. Kress. The seat represents the 27th District.

Charter Commissioner, also from the 27th District, will be decided between Democrat Walter T. Hink and Republican Hagbard "Bart" Berg.

Other county offices on the ballot include the prosecuting attorney, sheriff, clerk, treasurer, register of deeds, drain commissioner and auditor. Of those, only the offices of sheriff and drain commissioner are contested.

In addition to races for executive boards of three state universities and federal office candidates, voters must also decide the fate of several ballot proposals. The proposals range from tax cuts to lowering the drinking age. For a more complete summation of the ballot proposals, see the Oct. 22 edition of The Crier.

# GRAND OPENING

## CORNWELL'S

# Christmas World

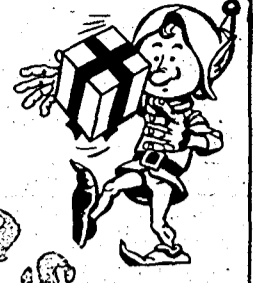

- Over 50 trees to choose from!
- Candle Sets
- Fantastic selection of Lights

## MOUNTAIN KINGS

The luxurious well proportioned tree that can be completely assembled in less than five minutes. Millions of people who saw it on TV agree. Now available at Cornwell's.

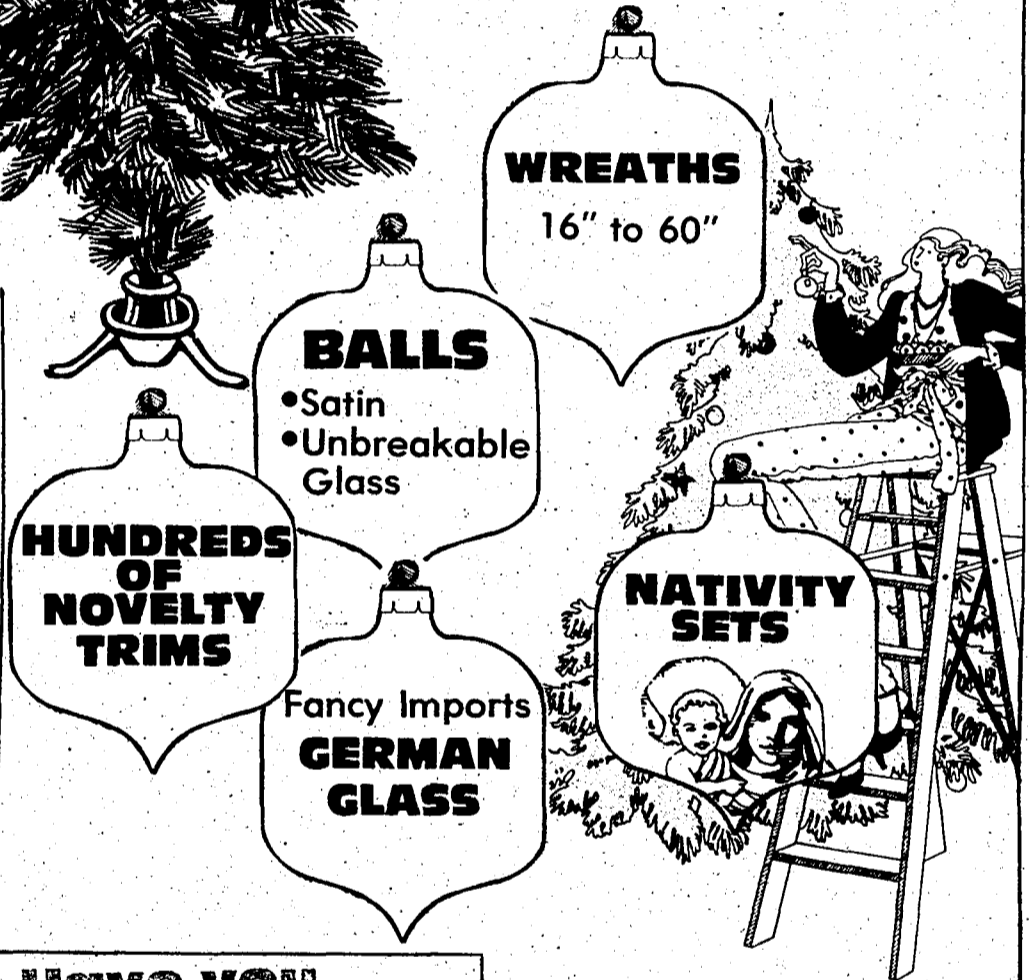

WREATHS

16" to 60"

BALLS

- Satin
- Unbreakable Glass

HUNDREDS OF NOVELTY TRIMS

Fancy Imports  
GERMAN GLASS

NATIVITY SETS

## Have you heard?

Best kept secret in Plymouth is that Cornwell Pool & Patio has the best selection of artificial Christmas trees and Christmas decorations.

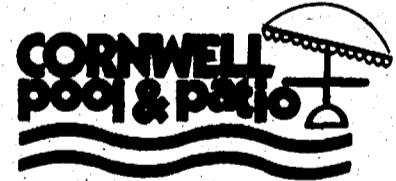

874 Ann Arbor Rd, Plymouth  
459-7410

Winter Hours: Mon-Sat 10-6  
Closed Wed. & Sun.

## COUPON

# ONE FREE CHRISTMAS ORNAMENT

With this coupon - your choice  
Select Merchandise

Offer expires Nov. 11, 1980

NOVEMBER

1980



# THE COMMUNITY CALENDAR

SUNDAY	MONDAY	TUESDAY	WEDNESDAY	THURSDAY	FRIDAY	SATURDAY
						<b>1</b>  Childbirth & Family Resource Center - nutrition workshop 10 am-12:30 pm info 455-0966 or 459-2360. Punt, Pass & Kick - 9 am, Griffin Park.
<b>2</b>	<b>3</b> Optimist Club, 7 pm Mayflower Hotel. Canton Rotary, noon Roman Forum. Plymouth symphony League, board meeting 9:30 am - Hostess Judy Dahlberg. Canton Kiwanis 6:30 pm Cyprus Gardens. Pilgrim Shrine No. 55 7:30 p.m. Grange Hall. PCAC - Board 9:30 am PCAC office. Recovery Inc. 8 pm Central School. Sigma Kappa, 8 pm Xmas Ornament info 459-1195.	<b>4</b> Don't forget to vote. Precincts open 7 am - 8 pm. Ply. Kiwanis, 6:30 pm Mayflower. Canton Jaycees, info call 981-1805, general meeting, guests welcome, 8 pm. Ply. Community Chorus, 8-10 pm East Middle School. Creditors, Elks Club, 12:30 pm-3 pm. Chess Club, 7-11 pm Cultural Center.	<b>5</b> Canton Newcomers, general meeting, Pioneer Middle School 7:30 pm Craft Auction. Girl Scouts - Ply.-Northville-Canton Assoc. Meeting 7-9:30 pm West Middle School. Soroptimist Board 7 pm Rutledge Heating. Fall Festival Board 8 pm Pupil Personnel office. Canton Chamber - 12 noon Roman Forum. PCAC Art Rental Gallery, 10-9 pm Ply. Library.	<b>6</b> Senior Citizens Club Tonquish Creek, 1-4 pm. Lions Club, 6:30 pm Mayflower Hotel. Colonial Kiwanis, 12:05 Mayflower. Canton Singers, 7:30 pm Canton High. Senior Citizen Party Bridge, 1-5 pm Cultural Center. Senior Citizens Club 1-4 pm Tonquish Creek. Plymouth Newcomers 11:30 am Mayflower Meeting House.	<b>7</b> Western Suburban Stamp Club, 7:30 pm Ply. Cultural Center Tom Martin Quiz. The Woman's Club of Plymouth, 7:30 pm Early American Music, St. John's Episcopal Church. Pioneer Canton Senior Citizens 12:30 pm Rec. Center. Ply. Rotary 12:05 Meeting House. Ply. Theatre Guild presents "You're a good man, Charlie Brown" 8 pm Central Middle School.	<b>8</b> St. Kenneth Christmas Bazaar at church 9:30-6 pm. Canton Newcomers, Millionaires Party, 8-12:30 info 981-1520. Ply. Theatre Guild presents "You're a good man, Charlie Brown" 8 pm Central Middle School. Centennial CB business meeting, 1-4 pm Oddfellows Hall.
<b>9</b> Dedication of Canton Public Library 2:30 pm Open House 1-5 pm. St. Kenneth's Christmas Bazaar at church, 9:00-2:30 pm.	<b>10</b> Toastmasters International 6:30 pm Mayflower Hotel. American Legion Post #391 Memorial Home 8 pm. Rock & Mineral Society 7:30 pm Ply. Cult. Center. Ply. Br. Nat'l Farm & Garden Assoc., noon, casserole lunch, craft auction. Canton Rotary, noon Roman Forum. Canton Kiwanis 6:30 pm Cyprus Gardens. Canton Business & Professional Women's Club 6:30 pm Roman Forum. Knights of Columbus 7 pm KFC Hall.	<b>11</b> Bank Closed. Apple Run Garden Club, 7:30 pm Hostess Elaine Lanvaders home. Ply. Kiwanis, 6:30 pm Mayflower. Canton Jaycees, 7:30 pm Canton Rec. Center. Ply. Community Chorus 8-10 pm East Middle School. Alpha Xi Delta, Handicraft Auction 7:30 pm Hostess Carrol Lewis. Ply. Jaycees 8 pm Hostess Jacki Vachow. Creditors Elks Club, 12:30-3 pm. Ply. Comm. Council on Aging, 2 pm Cultural Center.	<b>12</b> Soroptimist Club, 6 pm Rutledge Heating. Senior Citizen Happy Hour 12-4 pm Cultural Center. PCAC Art Rental Gallery, 10-9 pm PCAC office. TOPS Club, 7 pm Plymouth Grange.	<b>13</b> Ply. Jaycees 7:30 pm Ply. Cultural Center. Lake Pointe Village Br. WNFGA 7:45 pm Hostess Virginia McGraw. Colonial Kiwanis, 12:05 Mayflower. Canton Singers 7:30 pm Canton High. Canton Public Library "Beautiful New You" 7 pm girls 12 & up. Ply. Historical Society, 7:30 pm Museum. Canton Historical Society - 7 pm Canton Fire Hall.	<b>14</b> Parents w/o Partners General Meeting 8:30 pm, Cultural Center, contact 455-1255. Ply. Rotary 12:05 Meeting House. Pioneer Canton Senior Citizens 12:30 pm Rec. Center. Ply. Theatre Guild presents "You're a good man, Charlie Brown" 8 pm Central Middle School.	<b>15</b> Ply. Theatre Guild presents "You're a good man, Charlie Brown" 8 pm Central Middle School. Apple Run Garden Club, Christmas Craft Auction 3 pm Honey Tree apartments.
<b>16</b> Parents w/o Partners, Family Activity Bowling & Pizza, Plaza Lanes 2 pm contact 455-0639.	<b>17</b> Sarah Ann Cochrane Chapter DAR birthday luncheon Mayflower Hotel 11:30 am. Ply. Registered Nurses, Tour of Receiving Hospital 6 pm Ply. Township Hall for Car Pool. Optimist Club, 7 pm Mayflower Hotel. Canton Rotary, noon, Roman Forum. Canton Kiwanis 6:30 pm Cyprus Gardens. Plymouth Business & Professional Women's 6:30 pm Hillside Inn "Craft-mart" for members.	<b>18</b> Ply. Chamber General Luncheon 12 noon Hillside Inn. St. Kenneth's Senior Citizens 12-2:30 pm. Ply. Community Chorus 8-10 pm East Middle School. Ply. Kiwanis 6:30 pm Mayflower. Canton Library puppet play house 7-8 pm 5 yr. & up. Register Nov. 10. Creditors, Elks Club, 12:30-3 pm. Chess Club 7-11 pm Cultural Center.	<b>19</b> American Assoc. of Retired People, Lawrights Restaurant 12 noon. Mich. Assoc. C.L.D. 7:30 pm Pioneer Middle School. Canton Library, A Pocket Full of Stories 4 pm 6-9 yrs. Register Nov. 10th. Kiwanis presents Jim McDonald "King Arthurs Britain" Salem High, 8 pm. PCAC Art Rental Gallery 10-9 pm Ply. Library. Soroptimist Club, Presidents Council 6:30 pm Mayflower Hotel.	<b>20</b> Mayflower Garden Club Christmas Decorations 10 am Hostesses Dorothy Fulton, Joyce Ankofski. German American Club 8 pm Oddfellows Hall. Ply. Chamber Board, 8 am Hillside Inn. Canton Library, Goodnight Owl 7 pm 3-5 yrs. Register Nov. 10th. Am. Assoc. University Women, League of Women Voters, 7:30 pm West Middle School "Energy." Civitans 7 pm Hillside Inn.	<b>21</b> Plymouth Rotary, 12:05 Meeting House. Pioneer Canton Senior Citizens 12:30 Rec. Center. West Sub. Stamp Club, Ply. Cultural Center, 7:30 pm. Plymouth-Canton Wine Tasters, info 397-1784.	<b>22</b> Canton Jaycees, Annual Craft Fair, Canton High 9:30-5 pm. Canton Library, Magic Show, 2:30 pm All ages, register Nov. 10th. Centennial CB Social Meeting, 1-4 pm Oddfellows Hall.
<b>23</b> Plymouth Symphony Society Concert, 4 pm Ply. Salem High Auditorium.	<b>24</b> Canton Rotary noon, Roman Forum. Canton Kiwanis, 6:30 pm Cyprus Gardens. Toastmasters International 6:30 pm Mayflower Hotel. Recovery Inc., 8 pm Central School.	<b>25</b> Creditors, Elks Club, 12:30-3 pm. Ply. Kiwanis, 6:30 pm Mayflower Hotel.	<b>26</b> Family Service Advisory Comm. 8 am Colony Plaza Office. TOPS Club, 7 pm Plymouth Grange.	<b>27</b> Bank Closed.  <b>THANKSGIVING DAY</b>	<b>28</b> Santa arrives in town Kellogg Park, 6:30 pm Christmas Tree Lighting Ceremony. Parents w/o Partners, General Meeting, 8:30 pm Contact 455-1255 Cultural Center. Christmas Arts & Craft Show, 11-9 pm Cultural Center. Plymouth Rotary 12:05 Meeting House. Canton Jaycees "Visit Santa at his Work Shop" opens in Meijers Thrifty Acres.	<b>29</b> Christmas Arts & Craft Show, 11-9 pm Cultural Center.
<b>30</b> Christmas Arts & Craft Show, 11-5 pm Cultural Center. Parents w/o Partners, Family Activity Soccer Game Silverdome, Reservations by Nov. 15th info 453-0692.						

This is your Community Calendar, designed to make it easier and more convenient for you to keep up with events in the Plymouth-Canton area. Look for it on the last Wednesday of every month in The Crier.

And when it comes to making your financial affairs easier, we hope you'll stop by either of our branches . . . where you can find services like minimum balance no-charge checking, 5.46% Effective Annual Yield on regular 5.25% savings, low interest installment loans, safe deposit boxes and a lot more. Including a friendly staff of helpful FNB people who want to make banking as pleasant as they can for you.

Stop by soon!



## FIRST NATIONAL BANK OF PLYMOUTH

Main Office: 535 South Main, 459-9000  
Ann Arbor Rd. Office: 39475 Ann Arbor Rd., east of I-275  
Member FDIC

### HOW TO LIST YOUR GROUP'S HAPPENING

If you're having an event of interest or importance to the community at large, simply submit information about it in writing to the Community Crier, 1226 S. Main, in Plymouth by the Thursday preceding the last Wednesday of the month.

There will be no charge for items of civic, cultural, school or service club note. For further information, call The Crier at 453-6900.

### EMERGENCY PHONE NUMBERS

#### POLICE

City of Plymouth	911
State Police	348-1505
Wayne County Sheriff	721-2222
Canton Police	397-3350

#### FIRE-AMBULANCE

City of Plymouth	911
Plymouth Township	453-2545
Canton Township	981-1111



**Geneva's  
of Plymouth**  
Bridal Shoppe  
NOW OPEN THURS. & FRI.  
EVENINGS UNTIL 9 p.m.  
Mon.-Tues.-Wed.-Sat. 10-6  
#17 Forest Place 455-4445

# Trustee candidates differ on farms

BY DAN BODENE

Canton trustee hopefuls responded to questions ranging from farmland preservation to industrial growth at a candidates night Thursday.

Sponsored by the League of Women Voters and Canton Jaycees, the event allowed candidates to address questions from township residents.

Asked how much money they would commit to help spur industrial development in Canton, all trustee candidates agreed the issue was important, but a specific dollar amount to commit was impossible to determine. Republicans Loren Bennett and Stephen Larson felt any funding should stay within Canton's budget, while Democrat Mary Dingledey and Republican Duané Bordine agreed township residents should decide how much and where funding would come from.

Trustee hopefuls were asked which of the three tax proposals on the ballot they would support, and how each would affect Canton.

Larson and Dingledey both agreed with the intent of Proposal D, the Tisch Amendment, while Bordine, Bennett and Republican Bob Padget agreed the results of all three would severely hurt the township.

Democrats Larry Bowerman and Gary Roberts both supported Proposal C, the legislative-gubernatorial plan which would provide property tax relief. Democratic incumbent Carol Bodenmiller gave her support for Proposal A, the Smith-Bullard proposal, which provides for equal funding for students.

Whether township ordinance officers should carry guns was asked of candidates, and only incumbents Larson and Bodenmiller supported the present township policy of arming the officers. They both stated the position that ordinance officers were adequately trained to warrant carrying firearms, and that life-threatening situations forced their issuance.

All other candidates opposed the policy, questioning whether life-threatening situations should be handled by ordinance officers.

Trustees also addressed the question of whether they would encourage or discourage low-income housing. Although possible legal ramifications of answering the question were mentioned, only Dingledey did not respond.

Bowerman, Padget and Bordine stated a better definition of low-income housing was needed, while Bodenmiller and Bennett said Canton already has its share of the housing and probably wouldn't be ordered

to construct more in the near future. Most trustee candidates agreed the question dealt with a "touchy subject," and more study was needed before a fair response could be given.

Growth control and whether candidates felt it was a dead issue was also asked of the panel. Although Roberts and Dingledey said it was a dead issue, both added growth control would again be an important item in the future.

Bordine added the issue was closely tied to farmland preservation, and wondered whether residents in the western half of the township would be treated equitably in the face of more development.

The issue of farmland preservation efforts and how they could be financed was soon asked of the candidates, with varied responses.

Padget, chairman of the township's Planning Commission, supported the issue, saying the township should purchase development rights with local funds for "legal and moral" reasons. Additionally, he supported placing the question on a May ballot, a suggestion supported by Larson.

Bodenmiller and Bennett also supported farmland preservation, to help insure an adequate supply of tillable land for food production.

Bordine, a longtime Canton farmer, said, "Our property is our pension," supporting the Right to Farm law instead.

Mary Dingledey felt the farmland preservation act was unfair, saying farmers really did not like the idea and funding for it was unavailable.

Roberts urged that farmers should not have their land taken away, adding, "We should give farmers rights to individual benefits."

Bowerman stated Canton residents have not voted against the law, but have blocked funding from a millage increase. He advocated a hybrid plan for funding utilizing a tax relief system.

## Joyner seeks reform

R. William Joyner, Democratic candidate for Wayne County Board of Commissioners, said he has worked hard to clean up county government.

Currently the incumbent representing the county's 27th District, which includes the Plymouth-Canton Community, Joyner spoke at the League of Women Voters' candidates night on Thursday at Canton Township Hall.

Darrell Kress, Joyner's Republican opponent, did not show up.

"Citizens have demanded reform, but it has been blocked by other (county) commissioners," said Joyner, who lives in Plymouth Township. "I proposed a county executive, but it was defeated by the board of commissioners 26-1."



## DANCE UNLIMITED

757 W. Ann Arbor Trail  
459-5920

- Ballet
- Jazz
- Tap
- Trim
- Creative Movement for preschool

New Semester Beginning Monday,  
November 3rd

**Register Now**

AFFILIATED TEACHER  
of the American Society of  
Russian Style Ballet

PATRON MEMBER  
Of the Michigan Dance  
Association

SUPPORTING MEMBER  
American Dance Therapy Assn.

## Announcing the Opening of Forest Place's Newest

*The Yellow Rose*  
of Plymouth

Fashions for the Life You Lead

470 Forest Place

455-6960



## Westchester Square

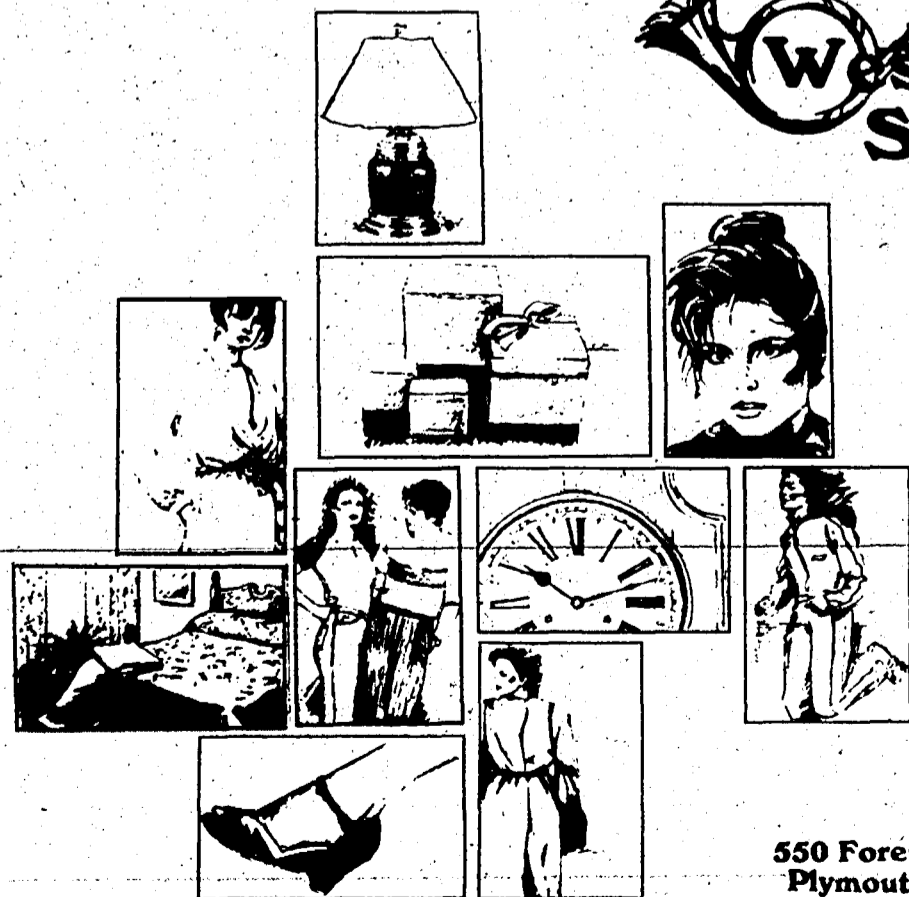

- A. Sacks of Forest Ave. 459-7940  
Classic Clothing for Women
- B. Tadmore's 455-0350  
Specializing in Large & Half Sizes
- C. Charlie's Corner 459-9530  
Your Hallmark store
- D. Ozzie's Guys & Gals 455-5858  
Back to School, College, or Work
- E. Mayflower Lighting 459-8880  
Light Fixtures for your every need
- F. Corner Curtain Shoppe 453-0640  
Country Style Curtains & Bedspreads
- G. Beautiful People Hair Forum 459-2880  
Timely hair fashions for women & men
- H. Campbell's of Plymouth 455-1810  
Clocks, Jewelry and Repair
- I. Shoe Attic 459-6380  
Fine women's footwear
- J. Sportventure 459-0820  
Quality Sport Clothing & Equipment

550 Forest  
Plymouth

(Behind Mayflower Hotel)

MALL HOURS:  
Daily 10-6  
Friday 10-9

## Edward B. Trachtman D.O. Practice of Family Medicine

Serving the  
Plymouth - Canton  
Community  
Plymouth Professional Building  
9416 South Main Street  
Plymouth, Mich. 48170  
Office Hours Telephone:  
by Appointment 455-2970

# Twp. trustee candidates differ on shared services

Sharing services with other local communities shouldn't be a dead issue, said Lee Fidge, a Republican incumbent for the Plymouth Township Board of Trustees.

She was speaking at candidates night last Tuesday, sponsored by the local League of Women Voters and the Lake Pointe Homeowners' Association. Six candidates are vying for four trustee seats Nov. 4.

Incumbent Gerald Law, also a Republican, said he supports shared services. "Costs are rising," he said. "However, if it's not advantageous to the township, then I wouldn't (support it)."

Plymouth Township should stay in its present form of government -- that of a charter township, responded Andrew Pruner, a Republican candidate.

Democrat F. Patrick Downes, however, did not favor shared services with the City of Plymouth. Until the city makes a movement toward sharing services, it would be a losing venture for the township, he said.

Incumbent Republican Barbara Lynch suggested the township start unified services on a small scale first, such as the building departments and recreation programs, before tackling the complicated job of combining unionized departments, such as the fire department.

If elected, Democrat Don Skinner said he would work toward "total unification."

"We have enough available talent to come to a workable conclusion for the benefit of all," he added.

In their opening remarks, candidates differed in style. Some gave personal life histories while other candidates introduced themselves and moved quickly into their views on some of the township's issues.

Lynch cited the economy as the township's "major problem over the next four years."

"We have to make services more productive and more cost efficient so that we have a township as good tomorrow as it is today."

Skinner said he was a long-time resident, familiar with the township, and serving his third term on the township's Planning Commission. His work experience at Michigan Bell will also prove valuable and help him as a trustee in deciding budgetary affairs, he said.

Fidge said her past performance as a trustee merited support in the election booth Nov. 4. She was worked on updating the land use plan, establishing bike paths, eliminating the one per cent tax collection fee, and establishing a water and sewer extension plan, she said.

Expanding the township's industrial growth base is the primary goal of Downes. He said the township growth should be encouraged "like Livonia has done."

Pruner urged voters not to split their tickets. His goal is to maintain the present township services for residents, he said.

Township government affects residents'

day-to-day life, said Law. He told voters to look at the candidates carefully.

Asked their priority, if elected, candidates responded differently. Fidge said she would work toward unifying the Board of Trustees, which often casts 4-3 votes, trustees vs. administrators. She also said she would keep a close eye on the economy.

Skinner said board members should work together better, too. His second goal would be to represent the people.

The board should take care of "people problems" such as sewers, sidewalks, and traffic, said Downes. His primary goal would be to encourage industrial growth.

Pruner urged township leaders to provide more direction, "instead of taking such a lackadaisical approach."

With about 30 per cent of the township's budget coming from the state, careful planning in the budget should be encouraged, said Law.

Meanwhile, Lynch said she would continue to learn "everything I can" about the issues before voting. Furthermore, she said an in-depth study of the fire department should be made because the department needs "constant updating."

More than 70 persons attended the meeting which was held at St. Kenneth's Catholic Church.

## Berg says county needs overhaul

Bart Berg, Republican candidate for Wayne County Charter Commission, said the county is "in sad need of reorganization."

He spoke at the Plymouth-Canton League of Women Voters' candidates night Thursday. His Democratic opponent, Walter Hink, did not show up. He told the league that he was busy making preparations for his brother's wedding.

Berg, of Canton, said he supports either an elected or an appointed county executive. And he would prefer to see some qualifications written for a county executive.

The charter commission should also change how Wayne County road commissioners are selected to make the road commission more accountable, Berg said. The road commissioners should be appointed to three-year terms by the county executive, with a maximum of two terms.

Other departments in county government need to be reorganized, he added.

Hink, in a letter to the league, said he favors an elected executive. And the number of county commissioners should be reduced from the present 27, he said.

A Department of Financial Operations should be created, Hink added, to oversee county spending.

# WE'RE MORE THAN A NICE PLACE TO EAT

Our Thursday Seafood Buffet is like a visit to a New England fishing port. Let us unlock the pleasures of the briny deep for you. A whale of a salad bar, fresh Shrimp, Rainbow Trout, fried Clams, Mai Mai, Scallops Oriental, fresh Lemon Sole, and Jumbo King Alaskan Crab Legs to name a few items. Discover Culinary Delights from Davy Jones' Locker soon.

**5:00-9:30 Every Thursday**

## The Hillside Inn

4111 PLYMOUTH ROAD, PLYMOUTH, MI 48170

PG 23  
The Columbus Daily Courier, October 29, 1980



**For the next 10 days, you'll save no less than 20% and as much as 53% on every floor sample and every one-of-a-kind item at Plymouth Furniture!**

We've just been to market. We've made substantial purchases of new merchandise in the latest styles for the new season. We must clear our floor of merchandise now on hand in order to make room to display the new goods. Every upholstered piece, every lamp, every accessory, every wood piece... from the country's finest makers now on our floor must be cleared out. This is a once-in-a-lifetime opportunity to own fine quality furniture at a fraction of their original price.  
**SALE LIMITED TO STOCK ON HAND • NO LAYAWAYS • ALL SALES FINAL**

<p><b>2 Only! Founders No. 41 by Thomasville</b> <b>8 PIECE DINING ROOM</b> Includes 58" Breakfront, Trestle table, 4 side chairs and 2 arm chairs. Reg. \$3760. Save 1/2! <b>\$1880</b></p>	<p><b>2 Only! Founders by Thomasville</b> <b>4 PIECE BEDROOM SET</b> Includes Dresser, Mirror, Chest and Headboard. Was \$1490. Save 1/2 during this clearance. <b>\$745</b></p>
<p><b>4 Only! Reg. \$495 to \$1184</b> <b>LOVE SEATS</b> You'll save one-half on these lovely love seats from Flexsteel, Flair, Hickory and Vanguard. Lovely fabrics. <b>\$249 to \$582</b></p>	<p><b>15 Only! Reg. \$184 to \$557</b> <b>LOUNGE CHAIRS</b> You'll save 28% to 39% on this selection of Wing Chairs, Tub Chairs, Pull-Up Chairs and Recliners from Famous Makers. <b>\$139 to \$337</b></p>
<p><b>12 Only! Reg. \$995 to \$2888</b> <b>FINE SOFAS</b> Save 37% to 50% on a great selection from Classic Leather, Flexsteel, Vanguard, Seig and Flair. The leathers are a great buy! <b>\$495 to \$1800</b></p>	<p><b>1 Only! Reg. \$399 CHROME AND GLASS DINING TABLE</b> ..... Save 50% ..... <b>\$199</b> <b>3 Only! Reg. \$349 RAYMOUR RATTAN ETAGERE</b> ..... Save 28% ..... <b>\$249</b> <b>1 Only! Reg. \$279 GIBSON OAK SERVING CART</b> ..... Save 50% ..... <b>\$139</b> <b>1 Only! Reg. \$399 FOUNDERS STORAGE HEADBOARD</b> ..... Save over 50% ..... <b>\$99</b></p>

**All our famous makers!**  
**OCCASIONAL TABLES**  
Lamp, chairside, end, cocktail and sofa tables from Lane, Brandt, Founders, Hekman, Weiman, Hammary.  
**17% TO 53% OFF!**

**Every Fine quality piece in our stock!**  
**LAMPS AND ACCESSORIES**  
Great selection of floor lamps, table lamps, wall hangings, pictures. The finishing touch.  
**20% TO 50% OFF!**



**plymouth furniture**  
Exceptional Furniture at Exceptional Savings

OPEN MONDAY, TUESDAY, WEDNESDAY, SATURDAY 9 am to 6 pm - THURSDAY, FRIDAY 9 am to 9 pm



## Monogramming

by  
*Initially Yours*

Eight assorted styles and over 75 colors to choose from. Fast and dependable service. \$1.75 per letter. 3" and under.

Ask for Donna  
**453-6172**  
Joy & Sheldon Rds.



# Community The Crier

THE NEWSPAPER WITH ITS HEART IN THE  
PLYMOUTH-CANTON COMMUNITY

## Endorsement summary

### Plymouth-Canton

#### WAYNE COUNTY COMMISSIONER

R. William Joyner

#### WAYNE COUNTY CHARTER COMMISSIONER

Hagbard Berg

#### STATE BALLOT PROPOSALS

Proposal A -- No

Proposal C -- No

Proposal D -- No

Proposal E -- No

#### COUNTY BALLOT PROPOSALS

Proposal J -- No

Proposal K -- No

Proposal L -- No

Proposal M -- No

### Canton

#### 15TH DISTRICT U.S. CONGRESS

William D. Ford

#### 37TH DISTRICT STATE REPRESENTATIVE

Thomas H. Brown

#### CANTON TWP. SUPERVISOR

James E. Poole

#### CANTON TWP. CLERK

John Flodin

#### CANTON TWP. TREASURER

Maria Falkiewicz

#### CANTON TWP. TRUSTEE

Robert M. Padget

Larry K. Bowerman

Carol A. Bodenmiller

Stephen K. Larson

#### CANTON TWP. LIBRARY COMMISSIONER

Mary S. Feltz

Douglas J. Ritter

John O. Schwartz III

Katherine A. Baldrice

James Gillig

Norma Jean West

### Plymouth City & Township

#### 2ND DISTRICT U.S. CONGRESS

Carl D. Pursell

#### 52ND DISTRICT STATE REPRESENTATIVE

Roy Smith

### Plymouth Township

#### PLYMOUTH TWP. SUPERVISOR

Maurice M. Breen

#### PLYMOUTH TWP. CLERK

Esther Hulsing

#### PLYMOUTH TWP. TREASURER

Joseph West

#### PLYMOUTH TWP. TRUSTEE

Barbara J. Lynch

Gerald H. Law

Donald Skinner

Weyona Lee Fidge

#### PLYMOUTH TWP. CONSTABLE

Donald King

Francis E. Radwick

See pgs. 24-28

# View local races, then vote Tuesday

Don't forget to vote Tuesday, Nov. 4. The polls will be open from 7 a.m. to 8 p.m.

This year's presidential race is certain to draw voters to the polls, but don't forget to cast your ballot in local races, too.

As political observers have noted, local races often generate as much interest -- if not more -- than the national races. Why? Because local politicians directly influence our lives. They set our water rates, decide whether to seek extra tax dollars for special programs or services, and vote on where new subdivisions should be constructed.

So, view the local races in Plymouth Township and Canton with a keen eye on the can-

didates and their stances on the issues.

The posts in Wayne County, state House of Representatives, and U.S. Congress are equally important. As your representatives, these elected officials budget your tax dollars and decide the thrust of government spending.

The Crier urges you to consider the candidates, the ballot proposals and the issues in this election seriously. After all, if you choose not to vote Nov. 4, you're giving up your opportunity to speak out on the issues.

Vote Tuesday, Nov. 4.

THE COMMUNITY CRIER

## community opinions

### Defeat Proposal D: it's much too drastic

EDITOR:

The local League of Women Voters urges a "no" vote on Proposal "D," the Tisch tax cut proposal on the Nov. 4 ballot. The proposal ties desired property tax relief to provisions which so drastically alter our system of government and so severely cut essential state and local services as to be irresponsible and indefensible.

The total loss of revenues to local units of government will be at least \$2.6 billion.

No more than \$2 billion will be reimbursed by the state, leaving a loss to local units of government of at least \$600 million. The \$2 billion reimbursement from state funds will require a 55 to 60 per cent cut in the unallocated general funds.

These funds are used to support such services as: all-state universities, mental health programs, medicaid and other programs of the Department of Social Services, state police, corrections, courts, public health programs, services to senior citizens, parks and recreation.

Millions of federal dollars would also be lost due to reductions in matching funds. The required cuts in services would be particularly detrimental to the poor, elderly, handicapped and unemployed.

The requirement for approval of all new taxes (including fees, licenses, etc.) by a 60 per cent vote of the people is a serious alteration in our form of government. This form of government rests on the philosophy of electing representatives to evaluate needs and design a fair taxation plan to meet those needs within broad constitutional limitations.

The voter is already faced with long and

complicated ballots. Under this proposal, citizens would be required to educate themselves on the budgetary needs of every unit of government and to determine fair taxes to meet those needs. Taxes to be voted would include such things as university tuitions, dog license fees, fishing licenses and motor vehicle registrations.

An even more drastic alteration in our democratic form of government is the provision for minority rule. Requiring a 60 per cent approval of any new taxes means that 41 per cent of the voters could thwart the will of the majority on tax matters.

Under this proposal, neither the legislative bodies nor the voters themselves would be able to respond to emergencies by changing taxes before the next general election in 1982.

Tisch backers argue that their proposal would have the same effects as Proposition 13 has had in California.

This ignores the fact that California had a \$6 billion surplus for reimbursement to local units and that many new fees were instituted which would not be allowed under Proposal "D." Proposition 13 does not require all new taxes to go to the voters, and it does not limit overall state spending. Thus, the cuts in services will differ from California.

While many citizens desire property tax relief and spending cuts, we feel this proposal would be much too drastic. Proposal "D" must be defeated on Nov. 4.

NANCY J. WHITE

President

League of Women Voters

Northville-Plymouth-Canton-Novi



# Community The Crier

THE NEWSPAPER WITH ITS HEART IN THE  
PLYMOUTH-CANTON COMMUNITY



Recycle Your  
Newspapers

1226 S. Main St. Plymouth, Mich. 48170

(313) 453-6900

W. Edward Wendover, publisher; Chas Child, editor; Patricia Bartold, managing editor; Dan Bodene, reporter; Robert Cameron, photo editor; Ken Voyles, sport editor; Jay Koeman, asst. sports editor; Charlie Yerkes, cartoonist; Mike Carne, advertising and art director; Fran Hennings, Tina Jones, Bill Diesendorf, Sallie Roby and Vicky Downing, advertising consultants; Phyllis Redfern, office manager; Jackie Pack, business manager; Joyce Drewry, circulation manager; Joanna Darwish, asst. production mgr.; Karen Sanchez, typesetter; Laura Gerou, keyliner.



Member

PUBLISHED EACH WEDNESDAY  
by Plymouth-Canton Community Crier, Inc.

Carrier Delivered: 85¢ monthly; \$10 yearly.  
Mail Delivered: \$16 yearly in U.S.A.



Member

# Pursell better than carpetbagging O'Reilly

The two major candidates in Michigan's 2nd U.S. Congressional district offer voters two contrasting styles.

Carl Pursell, the incumbent Republican from Plymouth, is a low-key moderate. He is an experienced legislator who prides himself in his ability to make compromises, build coalitions, and get things done.

His Democratic challenger, Kathleen O'Reilly, on the other hand, is a vocal champion of consumer concerns. Crusading against such things as Big Oil, short-sighted American automakers, and the special-interest dominated Congress, she has energetically challenged Pursell, whom she says stands for "mediocrity."

We appreciate O'Reilly's hustle and leadership on some issues, but believe Pursell would make the better congressman.

We question whether O'Reilly, if elected, would represent the 2nd District or a narrow group of consumer activists in Washington, D.C., where she has lived for years, before recently moving back to her parents home in Plymouth Township to run for Congress.

Not that consumer issues are unimportant. But congressmen should also be well-connected with the home folks -- and able to create practical solutions to problems. With his experience in Michigan's state legislature, his two terms in Congress so far, and his important seat on the House Appropriations Committee, Pursell is better equipped to solve the district's and the nation's ills.

O'Reilly's solutions to our problems occasionally strike us as glib and in other cases simple repackaging of the same Democratic Party programs which have been tried and retried for 30 years.

Pursell however, could take a cue from O'Reilly's ability to focus attention on issues and provide leadership. The 2nd District, with Plymouth, Ann Arbor, and Ypsilanti, has a highly educated constituency and deserves more of a leader in Congress.

For those voters who don't like either Pursell or O'Reilly we're sorry to say that the two minor party candidates impressed us very little. John Wagner, of the American Independent Party, and Libertarian James Hudler are not well-versed on the issues and don't offer reasonable alternatives, even as protest votes.

Pursell's experience and solid base in the district makes him the best choice.

THE COMMUNITY CRIER

## 'No' on tax issues A, C, D

Vote "NO" on Proposals, A, C, and D on the Nov. 4 ballot. As currently written, these plans do not provide the tax relief needed by Michigan residents.

Since all three tax proposals would affect Plymouth-Canton governments, The Crier is making an endorsement on these statewide proposals.

Certainly the most devastating proposal for both state and local governments is the Tisch Plan (Proposal D). It would reduce appraisal of all property to 25 per cent of 1978 assessments.

Proposal D is irresponsible. It's foolhardy. It's like cutting off your foot because there's a corn on it.

Government -- both state and local -- provides many services for its citizens. We'd hate to see essential services eliminated because funds dried up.

The City of Plymouth, Plymouth Township, Canton, and the Plymouth-Canton schools will all be forced to make drastic reductions in services if Tisch is adopted. Less revenue means fewer services for residents, both in Plymouth-Canton and throughout the state.

Also, the proposal requires that new taxes be approved by 60 per cent of voters. So, if 59 per cent OK'd a tax, it would still fail. Minority rule is not part of the democratic process. Other implications of the Tisch Plan are also questionable. Vote "NO" on Proposal D.

Likewise, The Crier also urges you to vote "NO" on Proposals A and C. These two tax plans require further legislation before they are brought to the voters, particularly the Smith-Bullard Plan (Proposal A).

Proposal A represents a new method for financing public schools. It would shift educational support from the property tax to the state income tax. State income taxes and state-wide property taxes would be increased to offset lost revenues. The purpose of the proposal is to equalize state-aid-per-pupil to all school districts in the state.

In the long run, The Crier believes Proposal A, if adopted, would hurt local school districts, such as Plymouth-Canton. Under the plan, revenues would not keep pace with expenditures, thus forcing Plymouth-Canton

And, even though local school districts would retain control over hiring and programs, The Crier believes the types of programs which can be offered directly relate to the amount of money available from local taxpayers.

The powerful MEA (Michigan Education Association) has strongly backed this proposal in order to more directly affect government spending in school districts. Vote "NO" on Proposal A.

Proposal C would relieve the burden of residential property taxes by increasing the state sales tax from four cents to five and one-half cents. It would exempt the first \$7,100 of assessments on residential property. It was devised by the state legislature and Gov. William Milliken as an alternative to the Tisch Proposal.

Proposal C is a moderate effort at tax reform, but does not address the issue of government spending in general. Furthermore, the increase in state sales tax will probably not produce enough revenue to offset the decrease in property taxes. We recommend casting a "NO" vote on Proposal C.

THE COMMUNITY CRIER

## 'No' on E

Plymouth-Canton voters have a special stake in a little-talked-about issue on next Tuesday's ballot, Proposal E.

If approved statewide, Proposal E will authorize the construction of our regional prisons, including one next to Plymouth Township's DeHoCo on Five Mile Road.

We urge Plymouth-Canton voters to pull the "no" levers on Proposal E. Our community already bears at least its share of the state's prison population. Besides DeHoCo, there's the Phoenix Correctional Facility, a state prison, which was formerly DeHoCo's women's division.

We believe more prisons are needed in Michigan. But we can't support a plan that would put another one here. Vote "no" on Proposal E.

THE COMMUNITY CRIER

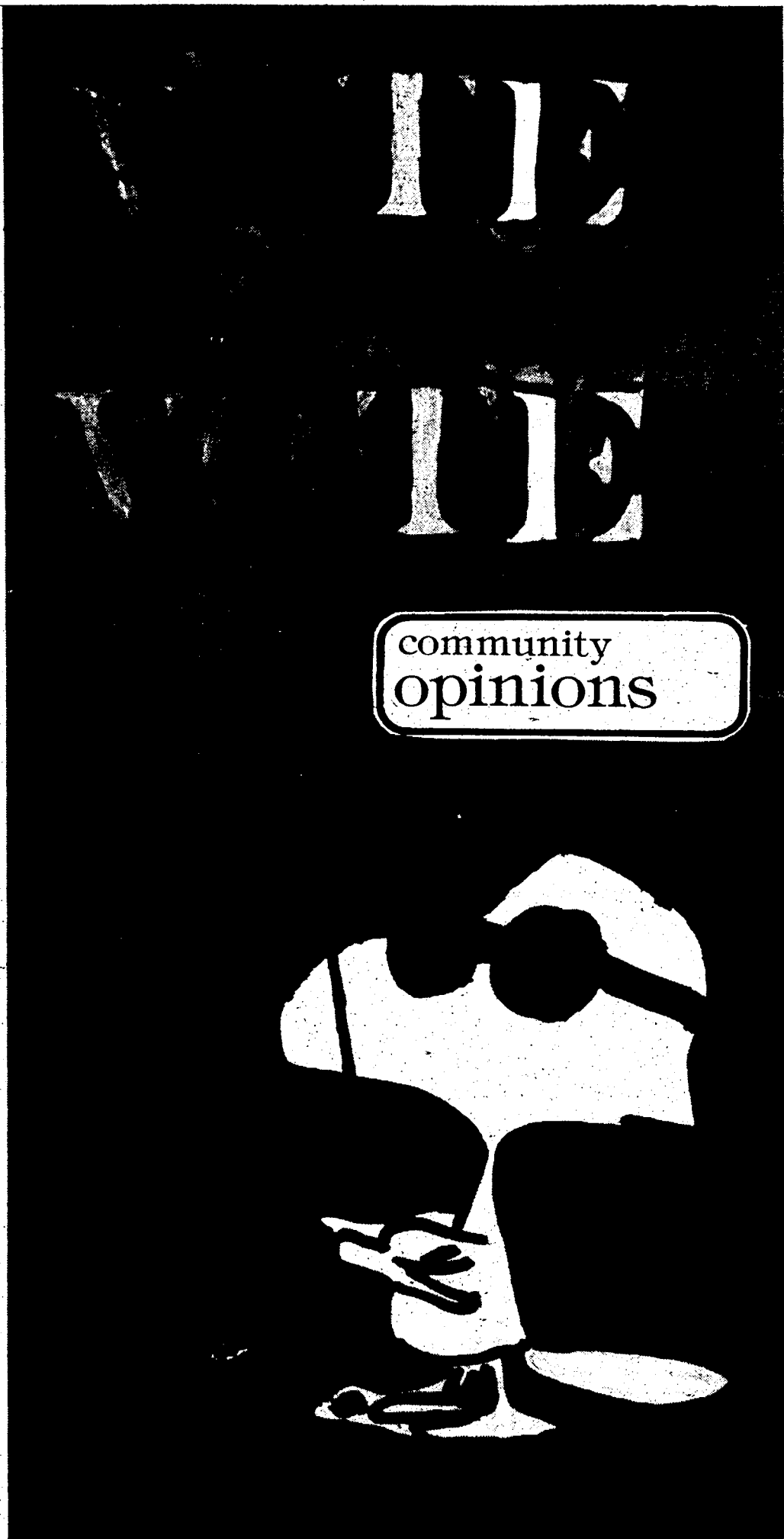

THIS POSTER by Karen Fullerton was one of several 'remember to vote' posters made by students in Carol Welsh's class at Allen School.

# Re-elect Ford in 15th, he's not the best, but.....

Incumbent Democrat William Ford represents a far superior choice over challenger Republican Gerald Carlson in the 15th District race for U.S. Congress.

Carlson, a self-proclaimed white supremacist, is a candidate from the lunatic fringe. He cannot be counted upon to fairly represent his constituents in the 15th District, which includes Canton Township. The fact that Carlson weathered the primary, beating moderate Republican James Caygill, should be an eternal embarrassment to voters in the 15th District.

Don't vote for Carlson.

Ford, on the other hand, is a disappoint-

ing Congressman. He is frequently inaccessible and seems more interested in the plight of labor unions than the rest of his constituents. However, Ford stands head and shoulders above Carlson in his ability to represent voters in the 15th District.

Ford represents an intelligent alternative to the bigotry and inhumanity Carlson represents. Third party candidate, Aldi Fuhrmann of the American Independent Party, has not launched serious campaign efforts in the race.

The Crier reluctantly gives the nod to Ford and hopes the 15th District voters will produce a better choice in 1982.



Please elect me!  
I'm as good as can be,  
And I'll never let you down.  
I'll cure all your ills --  
You know that I will,  
Can't you see how sincere I sound?

Not a promise I've kept,  
My opponent has wept --  
But I've done no worse than he.  
Let's hear your voice;  
It's time for your choice --  
The least of two evils is me.

Now when the deed's done  
And I can say that I've won,  
The tune will be mine to play.  
I'll forget about you  
And what you want me to do --  
Your wishes are now in my way.

The majority I find  
Can't change my mind --  
They pester and bother me so.  
If I do what they say,  
There's no possible way  
My power and fortune can grow.

Now to those pitiful few  
Who say, "Just wait -- I'll get you."  
Come vote time you will have none!"  
I'll again sound sincere  
And say what you want to hear,  
Apathy's the gift I count on.

JOE M. SLEZAK  
Plymouth Township

## Retail is No. 1

EDITOR:

In response to your editorial saying "Canton Merchants should work together," I would like to express my interest.

My background in television management, congressman's aide, and then as executive director of a large Chamber of Commerce is what prompted me to write.

In television, small and large retail merchants, for the most part, kept us in business. A sale must be made in any business in order for that respective business to continue operating as well as employ persons. No sale -- no employment -- no nothing.

Originally, and previous to the Chamber of Commerce, retail merchants formed their own associations to stimulate, promote and organize sales of merchandise or products. City Christmas decorations in most areas, as well as street and window decorations used during sales promotions and other times of the year, were originally purchased by the retail merchants of the area. Fortunately, through the years, city and industrial funds began assisting retailers in these purchases.

Now the Chamber of Commerce. The retail merchants were the first and strongest division of the chamber.

Then the business and/or industrial divisions were included under the chamber umbrella. Also legislative, ecological, convention and other arms were added depending on size, locale, and individual problems of the community involved.

The chamber is designed with a Board of Directors representing all divisions -- an executive board to make important decisions when the full board was not in session -- and the executive director to govern day-to-day operations including membership.

In order for the chamber to function efficiently and to the benefit of all divisions and the community, there simply cannot be any disrupting areas such as the retail merchants forming their own area of operations. There just has to be complete unity.

It's my opinion from my experience that someone or something has placed the retail merchants in Canton as No. 2.

Canton Chamber Board of Directors -- take a peek at all areas of your own organizations. I suspect you will end up placing the retail merchants where they rightfully belong -- as the No. 1 division.

JACK DEMPSEY

# Vote 'No' on all 4 county tax proposals

community opinions

Few people disagree that Wayne County government is mismanaged. Which is why we don't believe voters should approve the four proposals to raise county taxes on next Tuesday's ballot.

Only when county officials can demonstrate that they are responsibly managing the money they've got should they come to taxpayers for more, no matter how valid the need.

The four proposals are: Proposal J, K, L, and M. Proposal K would raise taxes of the county, school districts, unchartered townships, intermediate school district and Wayne County Community College a total of three mills.

Proposal K, L, and M all ask for one-half mill apiece for Wayne County General Hospital, mental health services, and operation of the Sheriff and Prosecuting Attorney offices, respectively.

Some of these functions need more money. But again, approval of these taxes will only give the county more money to mismanage.

THE COMMUNITY CRIER



## Chas Child is totally inaccurate

EDITOR:

Chas Child is totally inaccurate in his assumption that U.S. Rep. Carl Pursell is responsible for the shift of the Canton Township mail from Plymouth to Westland.

Since the inception of the Postal Reorganization Act of 1970, "politics" (intercession by individual Congressmen in the affairs of the local post office) is nil. The removal of Canton mail processing and delivery services from Plymouth to Westland is in concert with the transfer of the Wayne carriers back to their home base and is purely a matter of logistics.

To impute the credit for the move to Pursell is to impugn the ability of the U.S. Postal Service administrators.

Upper level management has been cognizant of the congestion problem for some time and did consider various alternatives to alleviate the situation.

Ultimately, the Postal Service took the most viable option at its disposal, short of opening a new facility in Canton Township.

It is my considered opinion that it was not Pursell but cogent factors such as service exigencies, cost considerations and prudent management that were responsible for solving the local post office's problem.

DAVID S. DAVIDSON  
Retired Postal employee

## Breen in Twp.

Republican Maurice Breen, a politician with many years' experience, represents the best choice for Plymouth Township supervisor.

As a member of the Board of Trustees, he is very familiar with the issues facing Plymouth Township. He has lived in the township for more than 20 years and has served on the township's Planning Commission. He was also township supervisor from 1970-72.

Democratic challenger Carol A. Levitte needs more experience before tackling the rigors of the supervisor's job. She should have considered a bid for a trustee seat on the township's board rather than seeking the supervisor's post. This move is indicative of the lack of judgment she'd demonstrated during her campaign.

Although far more experienced, Breen, nonetheless, needs a watchdog, familiar with township politics, to help him view alternatives on issues. The emergence of a strong watchdog would challenge -- and, in the long run -- bolster Breen's capabilities as a leader.

If elected, Breen should establish goals in Plymouth Township. Issues such as police services, joint services with other communities, road improvement, and establishing budgetary controls need to be addressed. Under current Supervisor Tom Notebaert, the township has lacked a strong sense of direction.

Breen can provide such leadership. He has

## Elect Lynch, Law, Fidge, Skinner in Twp.

Republican Barbara Lynch, Gerald Law, Weyona "Lee" Fidge and Democrat Donald Skinner deserve your support at the polls Nov. 4 for Plymouth Township's Board of Trustees.

The Crier is disappointed that Plymouth Township residents have not been given a wider field of candidates from which to choose. A total of four Republicans and two Democrats are seeking four trustee seats; two more Democrats could have filed to run.

Incumbents Law and Lynch have demonstrated a willingness to tackle some of the issues facing Plymouth Township. Through their past performances as trustees, they merit reelection.

Fidge is also an incumbent. Although she votes well and is a hard-working trustee, her style sometimes hinders her effectiveness as a politician. And, even though The Crier has disagreed with some of her actions as a trustee, she has, nonetheless, proven to be industrious and outspoken. We support her reelection Nov. 4.

A third-term member of the township's Planning Commission, Skinner also merits

## Maria, Maria

Two well-qualified candidates are running for Canton treasurer -- Democrat Maria Falkiewicz and Republican James Kearney.

We give the edge to Falkiewicz. After Treasurer James Donahue virtually abdicated in office, she did a good job holding the department together, first as a part-time deputy treasurer and later as full time.

She initiated an excellent investment program and has made a good start in improving the treasurer department's policies and procedures.

Kearney has a solid background and we hope he maintains his interest in local government. But Falkiewicz's experience and dedication make her the best candidate.

THE COMMUNITY CRIER

demonstrated his leadership abilities at recent township meetings. If elected, Breen should aim to serve the best interests of Plymouth Township and its residents.

Levitte is also well-versed on some of the issues facing Plymouth Township. Her ideas on studying joint services with other communities, considering police service alternatives, and establishing priorities deserve consideration.

However, her drawback as a candidate is her inability to work with the township board and administration rather than against them. Recently she filed a law suit against the board and six of its seven individual members, charging that the Open Meetings Act had been violated.

The Crier does not believe her charges will stand up in court. Furthermore, filing a law suit is not the only way to instigate changes in policies and procedures at Township Hall. In the long run, we believe Levitte hurt her image as a candidate by filing those charges.

The action is indicative of her lack of judgment.

Although Levitte has been an active observer at township board meetings and has a good voting record, she is not the more qualified candidate for the supervisor's post. She should be encouraged to remain active in township politics, but isn't ready to lead the township yet. Vote for Breen Nov. 4.

THE COMMUNITY CRIER

your consideration Nov. 4. He would be a fine addition to the board of trustees and could contribute insight and common-sense. His only drawback as a candidate is his lack of familiarity with some issues. However, by doing his homework as a trustee, The Crier is certain he can quickly overcome that obstacle.

The Crier does not support the election of Republican Andrew Pruner or Democrat F. Patrick Downes.

Downes is a one-candidate issue -- he promotes the expansion of the township's industrial base. Downes should familiarize himself more with some of the other issues facing the township, such as police alternatives and joint services with other communities.

Downes needs to present a more well-rounded approach as a candidate. We hope his interest in township politics remains high; his goal of dealing fairly with all taxpayers is laudable and should be remembered by trustees.

Pruner, who was defeated in his 1976 bid for a trustee post, has waged one of the more visible and active campaigns. He has attended many meetings of the board of trustees. And, even though we admire his steadfast attitude and persistent approach, The Crier does not support his election.

He has tiptoed around questions on substantive issues at recent candidates' nights. He has not been able to translate his attendance at board meetings into an issues-based platform for his campaign.

Pruner, however, could be an effective member of one of the township's committees -- such as the Public Safety Committee. He should be considered for such posts because he has demonstrated a long-standing, sincere interest in Plymouth Township.

Vote for Lynch, Law, Skinner, and Fidge on Nov. 4.

THE COMMUNITY CRIER

## Jim Poole is best for Canton's future

Despite his moderately successful record, The Crier is not supporting the re-election of Canton Supervisor Noel Culbert.

We believe Republican Jim Poole will provide better leadership, management of the township's various departments, and preparation for Canton's future.

Poole has long been active in township affairs. He served as a trustee from 1972 through 1976 and lost a bid for supervisor in 1974.

He has a strong background in land-use affairs and supports the Boulder, Colo. plan for growth management. The plan calls for limiting the number of building permits, sewer tap-ins, etc. according to the township's ability to absorb growth. This may well be a practical alternative to the township's farmland-preservation program, which, up until now at least, no one seems willing or able to pay for.

Poole also believes this plan should be prepared now, during the current growth slump, so the township can be ready and waiting for developers when the economy rebounds. This shows an ability to plan ahead, a quality lacking in Canton government.

Culbert's major weakness is his inability to manage township affairs. He doesn't plan ahead well. Although amiable, he doesn't work easily with people; he has trouble building coalitions. He tends to react to problems rather than prepare for them.

In short, he's a luke-warm leader. And Canton needs a leader to guide it through some tough issues in the next four years: farmland preservation; land use; sewer; vital services, such as roads, police, and fire; and recreation.

We believe Poole could tackle these problems more effectively than Culbert.

We do have some reservations about Poole, however. He can lose perspective on some issues and make mountains out of molehills. If he could become slightly less contentious, he would be a better candidate.

As it stands, though, Poole is better prepared and able to lead Canton for the next four years.

THE COMMUNITY CRIER

## Vote Padget, Bowerman, Bodenmiller, Larson

Possibly the best field of candidates in many years is seeking election to Canton's Board of Trustees, which places the township in an enviable position for this year's election.

With such an obviously well-qualified and stable field, The Crier had a considerably harder time endorsing only four candidates than in previous elections. We support Republicans Bob Padget and Stephen Larson, and Democrats Carol Bodenmiller and Larry Bowerman.

The Crier strongly endorses Padget. He has shown an expertise in dealing with major and minor issues facing the township, after long service on the Planning Commission and many other organizations. In addition, he frequently expresses a need for the board to work toward unifying the township and to treat residents and merchants alike with respect and dignity -- a sentiment we wholeheartedly support.

Padget will provide a stabilizing influence on township politics, which is badly needed. He has the professional background and the foresight to do the job effectively. Padget is not only an exceptional trustee candidate -- we believe he would make a good township supervisor in the future.

Larry Bowerman is another strong choice. Long active in Canton politics, Bowerman was narrowly defeated in the 1978 trustee race.

He also has the ability to help open communications with residents and groups outside the township. He advocates an end to Canton's "badmouth" image and recognizes the importance of the next four years in Canton's overall future.

The Crier also recommends incumbent Carol Bodenmiller for trustee. A proven, hard worker, Bodenmiller has repeatedly shown the willingness to go far beyond the three-Tuesdays-a-month scope of board meetings. In return, she has the confidence and support of many diverse groups within the township.

Bodenmiller is one of the best prepared and most involved trustee in many years, and can lend her experience to good advantage.

Stephen Larson, currently the only

Republican on the board, also merits our support for his fiscally conservative influence on board matters. Although he has not served a complete term as trustee, Larson has proven himself with his attention to detail and foresight in long-range issues.

He also provides a "watchdog" influence on township expenditures, and, coupled with a management background he can also help stabilize the frequently inflammatory nature of Canton politics.

The Crier regrets restricting its endorsements to four candidates because Democrat Mary Dingeldey is also a good choice for trustee. As a long-standing township resident, she boasts one of the most complete voting records of any candidate.

She has also frequently shown a willingness to work above and beyond the call of duty, exemplified by her involvement on behalf of Canton businesses.

Loren Bennett and Duane Bordine also merit recognition for their contributions. Bennett, a longtime advocate of farmland preservation, displays a much-needed attitude of dealing more closely with the people of the township. His grass-roots approach can provide a welcome facet to township politics in the future.

Bordine also adds a refreshing influence on the campaign with his emphasis on common sense and good judgment. However, he needs more experience in dealing with the complexities of township issues facing trustees.

Gary Roberts, a staunch supporter of Canton businesses, is no stranger to Canton politics. His flamboyant style causes us to wonder, however, whether he could contribute to the overall unification of the board. In his defense, Roberts has worked hard on many of the important needs of the township's residents and merchants. We look forward to his continued input to the board of trustees.

The choices for trustee endorsements were difficult to agree on. Our dilemma, however, is the township's gain, for such an obviously well-qualified slate of candidates can only lead to a well-qualified board of trustees.

THE COMMUNITY CRIER

# Smith best for 52nd

In the 52nd race for state representative, The Crier endorses Republican incumbent Roy Smith. The 52nd District includes the City of Plymouth and most of Plymouth Township.

Smith has shown an expertise in many areas of government, including taxes, assessments and budget. In tough economic times, that kind of expertise is needed.

Smith also has a keen interest in reshaping the political boundaries of the area. He supports re-districting to assure more accurate and fair representation.

His opponent, Democrat Judy Thiel, needs more experience in the political arena.

She is running to give women a greater voice in the legislature. Although we cannot disagree with her position, The Crier believes it carries more weight in Thiel's campaign than it deserves.

Her proposed economic policies also need more work. Many are simply not plausible in the state's complex economic system.

Smith, a long-time district resident, has the knowledge and experience to provide his constituents with a fair shake in the legislature. Although we look forward to seeing Thiel in later political races, we feel Smith is the best choice right now.

THE COMMUNITY CRIER

# Child's play

by Chas Child



Citizens who've watched the development of Canton politics in the last years should be gratified that the quality of candidates in this year's election is very high.

From supervisor to trustee, there are excellent candidates. Most of this is due to the resurgence of Canton's Republican Party. The local GOP has put up strong opposition to the long-dominant Democrats, especially for trustee.

The Canton League of Women Voters candidates night Thursday produced some of the best discussion of local affairs the community has seen in years. In fact, Canton is developing a group of leaders who seem harder working and more thoughtful than in neighboring Plymouth or Plymouth Township.

Plymouth Township suffers the same ill from which Canton is now apparently recovering: a stagnant one-party system. Although Democrat Carol Levitte is running for supervisor, and two Democrats are seeking trustee jobs, it doesn't appear the township's Democrats are seriously organizing.

The City of Plymouth elects city commissioners on a non-partisan basis. But this system seems to be worse than the two-party set-up. In the last election, only four persons filed for four seats. One of these, Tom Turner, dropped out because he planned to move to Venezuela, and the fourth spot was filled with a write-in ballot.

In the broader picture, a moribund one-party system in Michigan's 15th U.S. Congressional District, which includes Canton, has produced very poor representation in Washington.

The district is overwhelmingly Democratic and tightly controlled by the UAW. The union bosses call the shots and the result is long-time Congressman William D. Ford, a labor robot. Worse, Ford is rarely seen in his district. (For example, he was too "busy" to appear at Canton's League of Women Voters candidates night and at a scheduled interview with The Crier staff.)

Ford runs against token opposition every two years. Nobody keeps him on his toes and he acts it.

This year Ford doesn't even have token opposition. He has demented opposition -- Gerald Carlson, an avowed white supremacist. Carlson edged the regular Republican

candidate in the primary to win a spot on next Tuesday's ballot.

The two-party system is often criticized, but it sure beats the one-party system. The parties themselves shouldn't shoulder all the blame, though. Nothing will change the 15th District's Democratic party sitting back and being force-fed the UAW's fast-food politics.

And the district's Republicans can certainly don't believe that Gerald Carlson's foul racism represents their views. A simple higher turn-out at the polls could have kept Carlson's delusions safely within his two ears where they belong.

There's a common saying in politics: The people get the government they deserve. For the 15th District's sake, I keep hoping this isn't true.

# Why was city so against us?

EDITOR:

I could comprehend and understand the City of Plymouth's dilemma in awarding the Class "C" liquor license Wednesday evening, Oct. 15. I believe I understand wanting it to go to Old Village. Pat Hann has worked diligently and contributed endlessly to Plymouth, and the decision in my own mind was exceedingly difficult.

Her application was most deserving, but when the facts of the matter evolved, the necessary requirements could not be met. Why in the City's wisdom did it deny Emma's (restaurant) which apparently could meet the desired qualifications, one of the opportunities she needs to prosper and grow, which in turn enhances Plymouth?

Garey Beglinger by definition has more than paid her dues to the City of Plymouth with the renovation of the Iron Gate Galleries. I, myself, have worked tirelessly as a Fall Festival Board member, participated in local school programs, and have earnestly tried to make the bookstores a worthwhile contribution to the retail climate of Plymouth.

So, please, please, tell me why the city was so adamantly against us?

HAZEL M. GIBSON

PLEDGE		
NAME _____	Amount of Contribution \$ _____	
ADDRESS _____	Payment Herewith \$ _____	
	Balance Due \$ _____	
Signature required to validate pledge _____		
If Payment does NOT cover total pledged bill me Jan. 1 <input type="checkbox"/> Bill me quarterly <input type="checkbox"/>		
Please Designate your Contribution to:		
<b>PLYMOUTH COMMUNITY FUND</b>		
P.O. BOX 356, PLYMOUTH, MICH.		
Member of United Way of Michigan		

USE THIS coupon to pledge your donation to The Plymouth Community Fund. You can pledge through payroll deduction even if you work outside of the area.

# Re-elect Bill Joyner

Democrat R. William Joyner, Plymouth-Canton's incumbent county commissioner, deserves re-election.

Not only has he done a good job speaking out against the inefficiencies, corruption, and patronage in Wayne County government, but his opponent, Darrell Kress, has run an invisible campaign.

Republican Kress has not brought his case for election to the voters.

As the county tries to struggle out of its current mess, Joyner's voice and ideas will

be valuable. Although Joyner has worked hard on citizen problems, we believe he could work more effectively behind the scenes in county government, as his predecessor, Royce Smith, did.

While it's one thing to speak out forcefully, it's another to work with others, build coalitions, and fashion constructive change. Joyner can do more in these areas.

Despite this, Joyner is far and away the best choice and warrants your vote.

THE COMMUNITY CRIER

# Canton hinders business

EDITOR:

I read where small businesses in Canton continue to go down the tubes and it is my

community opinions

# No choice

It's too bad.

There are a number of candidates who face no opposition in this year's election. In Plymouth Township, Clerk Esther Hulsing, Treasurer Joseph West, and the two candidates for constable have no opponents.

Running unopposed in Canton are Clerk John Flodin and the six members of the Canton Library Board.

State Representative Thomas Brown, whose 37th District includes Canton and a portion of Plymouth Township, is also assured of winning another term since no Republicans or minor party candidates have filed to challenge his seat.

Voters deserve a choice. Incumbent candidates should have to face the issues and reestablish their positions to win voter approval. It's disheartening when no one stands up to run against an incumbent. It weakens the democratic roots on which our country is based.

Even if these candidates garner no votes other than their own, they are assured of victory. We hope voters remember this before the 1984 primary.

THE COMMUNITY CRIER

feeling township officials still prefer to hassle instead of help.

Woodling Gallery is another example of a struggling new business in Canton which the township ordinance department has chosen to hassle over a sign -- while right next door is a factory

Across the street is a sign much bigger and much higher, badly in need of repair and an eyesore -- and just across the way, every so often the stench from the local dump is so bad it is nauseating. Instead of handling ordinance infractions that are detrimental to the health and welfare of all, and a danger to surrounding buildings, they choose to pick on two women who are struggling to nurture a new business -- one which is attractive, unique, and an asset to the community.

A new business cannot afford an extra \$100, nor should they have to, to appeal an ordinance that obviously does not fit the case in point in the first place. A task force was formed a month or two ago to supposedly help this ordinance situation with small business. A letter on our behalf was sent to the supervisor, the ordinance department head, and to every member of the task force committee. As of this date (two weeks later), I have not heard from one of them.

We can't afford to pay citations, appeals board fees or lawyers, so I hope the township gets its act together soon and their priorities in perspective before more small businesses "hit the dust."

VIRGINIA ATTWOOD AND YVONNE ROEHLING  
Woodling Gallery

# How Crier endorses

Endorsements by this newspaper are made by votes of Crier staff members who have followed the election campaigns.

Candidates' statements, interviews and observations of the campaigns are all taken into account as well as staffers' knowledge of the political climate in Plymouth-Canton and past coverage of local and other governmental issues.

These opinions are intended to offer another aspect in your considerations before you enter the voting booth next Tuesday.

Crier staff members who participated in this season's political coverage are: Patricia Bartold, Chas Child, Dan Bodene, Phyllis Redfern, Bob Cameron, Mary DeGrande, and W. Edward Wendover. (In interviews and endorsements sessions on the race for Wayne County Charter Commissioner, Wendover, who lost a bid for that spot in the August primary, did not participate.)

# Berg best for charter

A long-time public servant, Republican Bart Berg, is the best choice for Wayne County Charter Commission in the 27th District, which includes the entire Plymouth-Canton Community.

Berg is well-versed on county problems, has stayed clear of special interests, which have smothered Wayne County's government, and is a fiscal conservative.

The Charter Commission will need these qualities to help straighten out the county mess.

His opponent, Democrat Walter Hink, has received the endorsements of such powerful labor unions as the UAW and the Teamsters. Ordinarily, endorsements aren't that important. But the UAW has pulled strings in county government too long to give it the benefit of the doubt in such a crucial body as the Charter Commission.

Berg is above all independent-minded and therefore just what the commission needs.

THE COMMUNITY CRIER

# community deaths

## Garber

Ralph Garber, 82, of Plymouth, died Oct. 22. Funeral services were held Oct. 24 at Schrader Funeral Home with The Rev. Kenneth E. Zielke officiating. Burial was at Grand lawn Cemetery.

He is survived by his wife, Helen C.; daughters, Barbara Jean Cate of Wilmington, Del. and Lou Ann Seely of Birmingham; son, Judge James N. Garber of Plymouth; nine grandchildren and seven great-grandchildren.

Mr. Garber originally joined the Wayne County Prosecutor's Office in 1935, later serving as chief assistant prosecutor for nine years. He retired in 1957, but served as Plymouth Township trustee from 1962 to 1970.

He was a member of Sigma Chi; Delta Theta Phi, a legal fraternity; Palestine Masonic Lodge no. 357, F&AM; King Cyrus Chapter, Royal Arch Masons; Detroit Commandry No. 2; Moslem Temple Shrine; Michigan Bar Association; and the First United Presbyterian Church.

## Hill

Yalmer Hill, 83, of Plymouth, died Oct. 14. Funeral services were held Oct. 18 at Schrader Funeral Home with The Rev. John N. Grenfell, Jr. officiating. Burial was at Riverside Cemetery.

He is survived by his wife, Elma M.; sons, Robert E. of Brighton and J. Frederick of Rochester; several nieces and nephews and five grandchildren.

A former Detroit police officer, Mr. Hill was a member of the Retired Police Officer's Association.

## Kelly

Daniel Joseph Kelly, 38, of Plymouth, died Oct. 14. Funeral services were held Oct. 17 at Schrader Funeral Home with The Rev. John N. Grenfell, Jr. officiating. Burial was at Riverside Cemetery.

He is survived by his mother, Velda Kelly of Plymouth; daughter, Stacey A. of Garden City; brother, Ben F. of California; sister, Nancy C. Slentz of Canton; and several nieces and nephews.

## Eaton

Doris Evangeline Eaton, 63, of Canton, died Oct. 19 in Superior Township. Funeral services were held Oct. 22 at Schrader Funeral Home with The Rev. Philip Rodgers Magee officiating.

She is survived by her husband, Claude; daughter, Nancy L. of Grand Rapids; brother, Ivan D. Campbell of Plymouth; and sister, Irene E. Smith of Plymouth.

Mrs. Eaton was a retired bus driver of the Plymouth Community Schools.

## Dodt

Oscar P. Dodt, 69, of Canton, died Oct. 15 at Redford Community Hospital. Funeral services were held Oct. 18 at Ross B. Northrop and Son Funeral Home with The Rev. Robert G. Johnson officiating. Burial was at Glen Eden Cemetery.

He is survived by his wife, Marion; daughters, Beverly Henry and Janice Kramer; sons, Richard, Robert and James Conger; brother, Vern Dodt; 12 grandchildren and six great-grandchildren.

Mr. Dodt was a former printer for the Detroit News.

## Telekesy

Stephen J. Telekesy, 65, of Plymouth, died Oct. 13 at Hendry Convalescent Center in Plymouth. Funeral services were held Oct. 15 at Our Lady of Good Counsel Church with The Rev. Fr. Kenneth MacKinnon officiating. Arrangements were made by Schrader Funeral Home. Burial was at Holy Sepulchre Cemetery.

He is survived by his wife, Elizabeth Putorek; son, Michael S. of Wayne; daughter, Michele Neu of Northville; sisters, Margaret Churilla and Teresa Faycik, both of Johnstown, Pa.; and two grandchildren.

Mr. Telekesy was a price analyst for Ford Motor Co., and was a member of Our Lady of Good Counsel Church and the Knights of Columbus of Plymouth.

## Croteau

Dagne V. Croteau, 69, of Huntington Beach, Calif., died Oct. 17 at Huntington Beach. Funeral services were held Oct. 21 at Our Lady of Victory in Northville with The Rev. Fr. John F. O'Callaghan officiating. Burial was at Riverside Cemetery.

She is survived by her daughters, Phyllis A. Richards of Salem and Helen M. Grant of Huntington Beach, Calif.; brother, Richard J. of Plymouth; sister, Joanne L. Croteau of Anaheim, Calif.; 10 grandchildren and six great-grandchildren.

## Greenlee

Shopia Greenlee, 83, formerly of Plymouth, died Oct. 20 at the Evangelical Home in Saline.

She is survived by her sister, Margaret Wood of Ann Arbor; nephew, Dave Henry of Plymouth; and nieces, Elaine Sempliner of Grosse Pointe Farms, Phyllis Stoll of Chelsea and Judy Henry of New Mexico.

Joining Michigan Bell in 1922, Mrs. Greenlee was transferred to the Plymouth office in 1930 and was the city's chief operator for many years.

## CEP voters prefer Anderson

A poll of Plymouth-Canton high school students showed these results in their presidential preference: John Anderson 42 per cent; Ronald Reagan 38 per cent; Jimmy Carter 18 per cent; and, others two per cent.

When choosing only between the two major party candidates, the results were as follows: Ronald Reagan 67 per cent

and Jimmy Carter 33 per cent.

The poll, based on telephone interviews with more than 100 teens in every high school class, showed that virtually all youths would vote if eligible, although 83 per cent thought their parents would vote this year. Of those polled 79 per cent said they would be interested in watching the televised debate between President Carter and former Governor Reagan.

The poll was sponsored by Christeens, the Youth of the Lutheran Church of the Risen Christ, Plymouth.

High school students were also asked if they thought their parents would have the same choices. Forty-one per cent said they would. Other items on the November ballot important to the teens were the tax issues and the drinking age proposal.

## Train hits car

A Livonia woman was injured late last Tuesday night when a C&O Railroad engine collided with her car at the Holbrook Street railroad crossing.

According to Plymouth police, Julie Diane Folgmann of 11415 Melrose in Livonia was southbound on Holbrook when she "slowed down but failed to stop for a stop sign" at the track, at 11:10 p.m. last Tuesday.

C&O engine no. 3911 manned by Robert A. Matuszak of Toledo, Ohio and John Newman of Dearborn Heights collided with Folgmann's 1978 Honda CVCC, causing extensive damage to the driver's side of the vehicle.

A rescue unit from the Plymouth Fire Department transported Folgmann to Botsford Hospital, where she was discharged later that night, according to a hospital spokesman.

## addenda & errata

A typographical error in last week's Crier was made in Kathleen O'Reilly's candidate statement. Under the Reagan tax cut plan, which she opposes, middle class persons with a \$20,000 income would receive a \$132 tax cut. She is a candidate for U.S. Congress, 2nd District.



## Come Worship With Us

### Epiphany Lutheran Church

41390 Five Mile Rd.  
1/2 mile west of Haggerty  
420-0877  
Pastor Fred Prezioso; 420-0568

Sunday Worship 10:30 a.m.  
Nursery Provided

### Plymouth Church of the Nazarene

41550 E. Ann Arbor Tr.  
453-1525  
Carl R. Allen, Pastor

Sunday School 9:45 a.m.  
Sunday Services 11 a.m. & 6 p.m.  
Midweek Service (Wed.) 7 p.m.

### Lutheran Church of the Risen Christ

Missouri Synod  
46250 W. Ann Arbor Rd.  
1 Mile West of Sheldon  
453-5252  
Rev. Kenneth E. Zielke

Sunday Services 9:00 & 10:45  
Sunday School 9:00 a.m.

### First United Methodist Church

45201 N. Territorial  
453-5280  
John N. Grenfell, Jr.  
Frank W. Lyman, Jr.  
Fredrick C. Vosburg

9:30 & 11:00 am Services  
and Church School

### Your Guide to Local Churches

#### Tri City Assembly of God

2100 Hannan Rd.  
N. of Michigan Ave.  
721-6832  
Rev. E. W. Ralmer, Pastor  
Sunday School 9:45 a.m.  
Morning Worship Service 11 a.m.  
Evangelistic Service 7 p.m.  
Ministry to the Deaf

#### First Baptist Church

45000 N. Territorial Rd.  
Plymouth 455-2300  
Pastors: Dr. William Stahl  
Rev. John Elliott

Sunday Services:  
Sunday School 9:40 a.m.  
Morning Worship 11 a.m.  
Evening Service 6:30 p.m.  
Wednesday: Family Night 7:00 p.m.

#### People's Church of Canton

Reformed Church in America  
Worshipping at Plymouth  
Canton High School  
8415 Canton Center Rd.  
Morning Worship 10 a.m.  
Adult Bible Class at 11:30  
Sunday School 11:30  
Nursery Available  
Rev. Harvey Heneveld Pastor  
981-0499

for 76 years . . .

A TRADITION

# SCHRADER

Edwin A. Schrader, Jr.

Edwin A. Schrader

# sports

## Canton cross country team ready for state finals



CANTON'S STEVE WEST puts forth a last second effort to sprint across the finish line ahead of a Farmington runner at the Class A cross country regional. (Crier photo by Jay Keenan)

BY JAY KEENAN

Consistent performances by the Canton cross country team Saturday proved its key to success as the Chiefs sprinted to a third place finish out of 25 teams in the Class A, section II of the Regionals.

Canton is now on its way to the Class A state finals. "We're very pleased," said Chiefs Coach Jim Hayes. "We were only a few points out of first place, but otherwise, we're all very pleased."

North Farmington took top honors in the race with 126 points, followed by Northville with 134 points, and Canton's total of 139.

"What it did for us once again was the fact that everybody finished in a pack all together," said Hayes.

Steve West led the Chiefs by legging out an 18th place finish in 17:15, including a last ditch, extra effort at the finish line.

Scott Hand was next taking 21st place with a time of 17:17, followed by Mike Talaga, 26th, 17:20; Jack Pacente, 29th, 17:41; Dan Inloes, 45th, 17:47, and Dan Henry 62nd, 17:52.

John Winterbottom paced Northville with a 12th place finish, while Detroit Catholic Central's Mike Nugent was the best overall runner of the afternoon.

"The consistency of our runners has been nice for us this year," said Hayes. "One of the best things that happened this year was when Talaga improved his time, along with Dave Bennett and Barren Smith to pick up the slack for Brian Jones after he injured his leg."

The Class A finals will take place next Saturday at Brookworld Golf Course in Flint. Boy's varsity will take off at 10:30 a.m.

"I'm very proud we're going to the finals," said Hayes. "It gives us another week to look forward to. This team is equipped with a dedicated bunch of kids."

Canton's girls' took a sixth place finish in the Class A section II race with 144 points. Redford Union was first with 43 points and Livonia Stevenson notched second position with 70 points.

Kathy Brophy sported the Chiefs best score of the day, finishing 19th with a time of 22:06. Brophy missed the opportunity to qualify in the state finals as an individual runner by only one place.

Other Canton scorers were Charlotte Thomas, 21st, 23:40; Patty Rising, 38th, 24:19; Kathy Seiler, 47th, 25:13; and Mary Bardelli, 51st, 26:17.

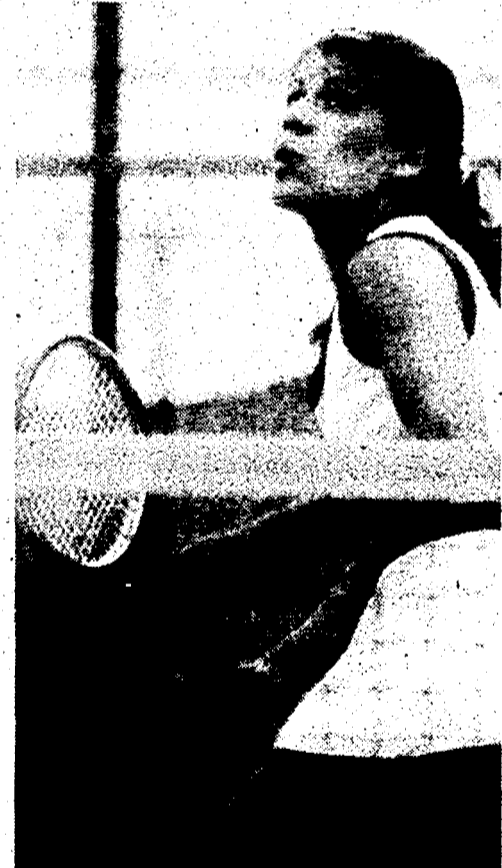

BETSY MOON (left) and Renee Braun (right) teamed up for a second place in doubles competition at the state finals. (Crier photo by Jay Keenan)

## Salem netters 6th in state

Renee Braun and Betsy Moon finished in second place at No. 1 doubles to help lead the Salem tennis squad to a sixth place finish at the Class A state finals.

Last year, the Rocks had finished eighth. "We did the best we could and that was generally pretty good," said Salem coach Judy Braun. "Chris Gilles did a fantastic job and so did Renee and Betsy."

"To know we actually went that far and did better than last year's eighth has got to make you feel good," said Braun. "A lot of people were not sure how good we were and here we are getting the best finish ever from a Salem tennis team."

Braun and Moon teamed up to beat teams from Loynorrix, Lahser, Midland Dow and East Lansing before losing to Grosse Point South in the finals, 6-1 and 6-0 to Echliand and Murtach from Grosse Point South.

No. 1 singles player for Salem Chris Gilles reached the quarter finals before losing to Mis Bonder 6-1 and 6-4, while No. 2 singles Carol Gillespie won her first round over Flint Carmen then lost to Maggan McMan.

No. three singles player Carol Hathaway beat Jeannie Ottolini of Warren Cousino then lost to Becky Maravic in round two. Sue Dobel at No. 4 singles won her first round over Linda Vanbrocklin then lost to an East Lansing player.

Lisa Maggio and Vickie Sterling beat a pair from Northwestern lost to a twosome from Marion.

Beth Baker and Lisa Hathaway lost to a pair from Midland Dow in the first round of competition.

"I honestly believe that in Renee and Betsy's final match they were a little tight and probably could have played better," said Braun.

Still a few left at the Truckload Sale Price

## TRUCKLOAD SALE

We've bought a truckload of Majestic products, and we're passing our savings on to you. Our package for a 1 story house includes: ESF fireplace, glass doors, fans, outside air kit, and all the pipe and chimney parts for a complete installation.

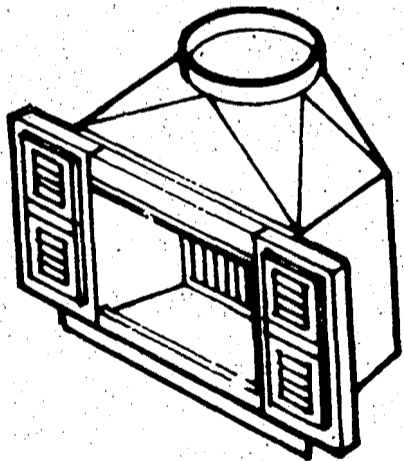

ONLY \$759<sup>99</sup> C&C

That's over 30% off list. Don't wait for winter to get here to install your fireplace. It's a great do-it-yourself project, we'll show you how. Call or stop in and see our display today.

**MAJESTIC**  
An American-Standard Company

WE ARE  
WOOD  
HEAT  
SPECIALISTS



HU 2-0735

THERE IS A MATERIAL DIFFERENCE

We Are 1 Mile East of Downtown  
Always Plenty of Free Parking Available

# Sample qualifies for state in Salem region effort

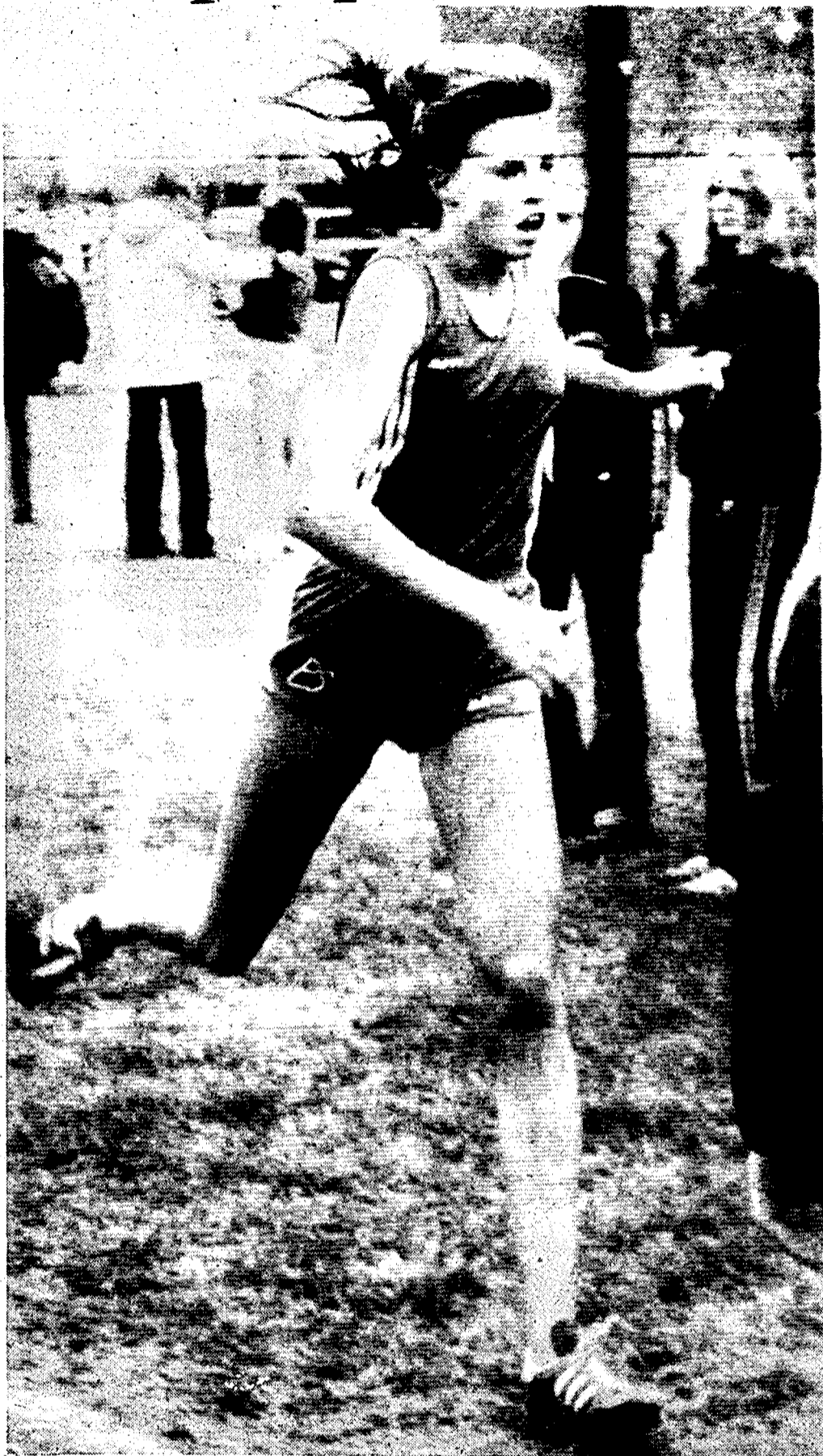

## Sample winds up qualifying effort

RUTH SAMPLE crosses the finish line in 14th place in the girls' Class A regional cross country race. Sample's effort allows her to run in the state finals this weekend in Flint. (Crier photo by Jay Keenan)

Salem's cross country squad competed in the Class A Regionals at Schoolcraft College last weekend and although the boys did not have a strong outing Ruth Sample qualified for the girls state finals to be held this weekend.

Sample reached the finals with a 14th place finish in the girls race that included some 75 runners. She will run in the individual girls finals this Saturday at Flint's IBM Golf Course at noon.

Lori Grissom was the other Salem girls runner. She finished the race in 42nd place.

As for the boys, Frank Brosnan had the

best effort with a 43rd place. His time was 17:43. Chris Whittaker was next at 17:51 for 56th place and Chris Kopach was 80th with an effort of 18:01.

Skip Whittaler was 84th for the Rocks, Brad Hartell was 100th, Ken Legault was 117th and Brent Bocson was 129th.

There were two sections in the Class A race. Each section consisted of 254 teams. Salem ran in section two. There were close to 350 runners in Class A competition.

Salem finished its duel meet season with a 3-3 record in the Suburban Eight and a 3-6 mark overall.

## Trenton overpowers Salem gridders in mud bath

BY KEN VOYLES

Trenton overpowered Salem in football Friday in a Suburban Eight League muscle match, 35-7. It was a rain soaked contest that was fought head-to-head for four full quarters.

"We had a good effort. Maybe it didn't look like it but our guys were giving their best effort," said Salem Coach Tom Moshimer. "Trenton was big and physically stronger than we were and in the poor field conditions their size was too much for us up front."

"We were close to mastering them up front. We used different interior linemen in different combinations to see what would work," continued the coach. "But they still were overpowering."

Moshimer also said that considering the field conditions his squad moved the ball halfway decent.

The Rocks also got themselves into a jam early in the football game when on their first play from scrimmage after the opening kickoff they fumbled the ball to Trenton.

Trenton took over inside Salem's 25-yard line and within six plays they were in the endzone. The clock had ticked off less than four minutes.

On their very next offensive series, the Rocks ran three plays then were halted and forced to punt. On that punt by Brian Lewandowski, the Rocks coverage was weak and Trenton was again in Salem territory.

With 3:17 left in the quarter, Trenton's quarterback plunged into the endzone. The extra point kick was good and Trenton led 14-0.

Salem's next drive, late in the quarter, was also stopped without a first down.

Trenton started another drive from its 45-yard line, after Salem's punt. The Tractors marched down the field (second quarter) and looked like they would score again.

This time, however, Trenton fumbled and Salem recovered on its 32-yard line.

Salem moved the football this time. The Rocks got their first first down to the 45-yard line then quarterback Jeff Hubert hit Mark Kitz on a 10-yard pass and Salem was into Trenton's end of the field. Hubert's

next pass fell incomplete and Salem had to punt again.

In the third quarter, Trenton took the kick-off and ran to midfield before being halted. From there the Tractors advanced to the 11-yard line where Trenton's quarterback again scored. The extra point was good and with 7:14 remaining in the quarter Trenton led 21-0.

Salem's brightest moment in the blight stormy night came after Trenton kicked to the Rocks.

Cont. on pg. 32

## Mite Bruins

The Plymouth-Canton Mite Bruins put forth their best hockey effort of the season Saturday, downing Livonia Bruins 5-1.

Plymouth's scoring came on a hat trick by Bobby Petrie with Brian Connell assisting on two of the goals. Bobby Royston added two more goals to close out the Plymouth scoring. Livonia's only goal was scored by Mickey Hunt.

The game featured especially strong play by all the Plymouth-Canton players with special mention to goalie Silvio Pruzinsky and center Joe Sellers.

The Plymouth-Canton Mite Bruins are: Ron Cathey, Brian Connell, Mike Corey, Brian Cronan, Phillip Doumanian, Ryan Hahn, Chris Jerry, Steve Mclellan, Arron Moorhouse, Bobby Petrie, Silvio Pruzinsky, Bobby Royston, Jason Sellers, Joe Sellers, and David Yockey.

## Lions football

The Plymouth-Canton Lions of the Western Suburban Football Junior Football League faced the Belleville Cougars last weekend and two of its squads came away in victory.

The freshman Lions beat the Cougars 21-0 and the varsity Lions won 13-0. The junior varsity suffered a 6-0 loss.

Record wise the freshman are 6-1, the junior varsity are 1-5-1 and the varsity are 3-1-3.

The Lions will end their season this Sunday at Ypsilanti.

## Dina's Mobile Doggie Coiffures

Professional Grooming  
...in Your Driveway



- Each Van is like a mini Salon on wheels
- Individual attention-One Dog at a time
- Nervous, Frightened pets are calm when they never leave the yard
- Price includes Clipping, Bathing, Ear Cleaned, Nail Clipped & Polished-Bows & Perfume
- Hand scissoring & Fluff Drying-Quality

**CALL 459-1129** After 5:00 p.m. **Evening & Sat. Appointments too**

## DON'T HAVE YOUR NEXT HOLIDAY PARTY WITHOUT US



United Rent-All has everything you need to make your party a complete success. From china, glasses, tables and chairs to serving utensils, champagne fountains and

even dance floors. All at reasonable rental rates. Delivery service is also available. Give us a call and rent a terrific time for you and your guests.

**UNITED RENT-ALL** Call: 455-2100  
510 Ann Arbor Rd.  
Plymouth

CELEBRATING 30 YEARS OF RENTAL INDUSTRY LEADERSHIP

**William M. Ross**  
D.O.P.C.  
**Howard M. Wright**  
D.O.  
**John J. Conry**  
D.O.

We are pleased to announce the opening of an additional office for Family Practice in Canton, Michigan.

**Plymouth Community Clinic — CANTON**  
3800 Lilley Rd.  
AT Ford Rd.

By appointment  
981-1744  
**Plymouth Community Clinic — PLYMOUTH**  
1311 ANN ARBOR ROAD  
By appointment  
453-8510

## Pittaway gains Salem's 1 TD

Cont. from pg. 31

On the first play from scrimmage, Rock back Bob Pittaway took a handoff on a counter of the left side of the field, and behind two key blocks scampered down the field to the endzone untouched.

The play covered 70 yards and with Lewandowski's extra point the Rocks scored their only points.

The blocks that made Pittaway's run perfect were thrown by guard Steve Szilagyi and end Mark Kitz.

Trenton, however, wasn't finished scoring. On their very next drive, the Tractors went 60 yards to make the score 28-7.

Then with 6:43 left in the fourth quarter, the Tractors added seven more points after driving from midfield.

"They scored those two quick touchdowns and we were out of it at that point," said Moshimer. "We still did a great job on defense and our kids gave us a solid effort."

"On Pittaway's run he got a key block right at the line from Szilagyi and then downfield Kitz threw another good block. Bob has great speed and nobody could have touched him."

Statistically, the Rocks gained a total of 185 yards on offense and had six first downs. Trenton had 352 yards total and 18 first downs.

Of these offensive yards, Salem gained 140 rushing and 45 passing. Trenton didn't throw one pass and got all its yards on the ground.

Salem evened its record, with the loss, to 4-4. The Rocks will try to break 500 this weekend when they face Farmington Harrison in their final grid clash of the year. The game is at Harrison at 2 p.m. this Saturday.



SALEM QUARTERBACK Jeff Hubert carries the ball closely pursued by a Trenton defensive play. (Crier photo by Robert Cameron)

## Canton netters make all-league

The Canton girls' tennis team had four players named to the Western Six All-League tennis squad at the close of the 1988 season.

Barb Rupprecht and Ann O'Connell were chosen to the team at No. 3 doubles, as both went undefeated with a 10-0 mark in their duel matches.

Marianne Pink, who elected to play tennis for her first time after working three seasons of basketball was also chosen at No. 3 singles.

Lori Smith was also awarded all league honors at No. 2 singles.

Canton coach Cyndi Burnstein announced her resignation as the Canton girls' tennis coach, after eight seasons in command of the team.

Burnstein, who was the Chiefs first tennis coach, will hand her job over to assistant coach Carol Michaels.

"This is my eighth year and I'd like to spend more time with my family," said Burnstein. "Michaels seems to be very competent to take over the job and I felt

indebted to have someone who knows what they're doing take over before I left."

Burnstein will continue to head coach the Canton girls' volleyball team which starts this winter.

## Canton football all-leaguers

Three players from the Canton football team were recently selected for the Western Six All-League team.

Senior tri-captain Craig Gerans, who has contributed on offense and defense for the Chiefs was picked at defensive tackle.

Senior defensive linebacker Ed Pieangelino was chosen for the 1988 team.

The other all-leaguer was senior offensive tackle Bruce King.

"It's pretty good to have three all leaguers from a team that's won only one game," said Canton coach Richard Barr. "We're proud to have them make it."

*Dorr W. Frisbee Agency*

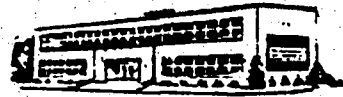

ORIGINAL INSURANCE CENTER  
SINCE 1923

**ATTENTION SAFE DRIVERS**  
**AUTOMOBILE INSURANCE**  
NOW AVAILABLE FOR PLYMOUTH  
AND CANTON RESIDENTS

**COMPARE THIS LOW COST QUARTERLY PREMIUM**

(NO FAULT INSURANCE)  
Provides Fully Coordinated Personal Injury Protection, Property  
Protection and Residual Liability (Basic Limits) Coverages **\$26<sup>93</sup>\*** Each 3 Months

- This Low 3 month premium is available to all drivers in the Plymouth and Canton area who have a minimum of 5 years of safe driving and are over age 30.
- Slightly higher for drivers under age 30.
- Comprehensive Fire & Theft, reducing deductible collision and Road service coverage available at same low cost premiums.

THERE ARE NO FINANCE CHARGES, NO COSTLY DUES  
TO PAY OR MEMBERSHIP TO BUY

**Our Complete Insurance Facilities Also Offer**

Substantial Savings of 20% on Fire and Homeowners Insurance.  
(Compared to Standard Bureau Rates)

Before you renew your Present Insurance, Call  
for a Rate Quotation without Obligation

CALL TOLL FREE TODAY **1-800-462-5434**

"Years of Experience" "Thousands of Clients"  
Serving Michigan Motorists Since 1923.

**Dorr W. Frisbee Agency, Inc.**

Representing American Fellowship Mutual  
Insurance Company  
(A Michigan Company)

## STIHL® Christmas Deals

THE WORLD'S LARGEST SELLING CHAIN SAW



Model 015R  
with 14"  
Bar & Chain **\$159<sup>95</sup>**

Model 010AV-16"  
with kit **\$209<sup>95</sup>**

Model 015L 14"  
Case, Chain, Oil  
& Woodcutter's Book **\$194<sup>95</sup>**

**SAXTONS GARDEN center inc.** 587 W. ANN ARBOR TRAIL  
PLYMOUTH 453-6250

# Chiefs lose on 2-point conversion

BY JAY KEENAN

Garden City East completed a two-point conversion following a third quarter touchdown to take a narrow 8-7 victory over the Canton football team Friday night, in a confrontation that was plagued by a steady, downpour.

The Chiefs defense let up only one time during the game, after Canton was charged with two costly penalties with the Panthers deep in Chief territory keeping East's scoring drive alive.

"Our defense did a great job," said Canton Coach Richard Barr. "They stopped them throughout most of the game. With the exception of that one good series Garden City had, we played real good football."

"The players are disappointed and frustrated, and I'm disappointed and frustrated, but I'm still proud of them. We gave it everything we had. The weather being what it was, we did extremely well."

The Chiefs struck first in the final minutes of the first quarter on a 53-yard scoring drive.

With East at its own 49-yard line, Panther halfback Tracy Bonner carried the ball across midfield, but the ball was batted loose by senior linebacker Ed Pierangelino and sputtered to the Canton 47, where it was scooped up by junior defensive back Jamie Chilcoff.

Several plays later with the Chiefs at the East 22, junior halfback Mike Clayton took a pitch from senior quarterback Bill Childs and lunged to the Panther eight-yard mark.

After an offside penalty put Canton back at the East 14, the Chiefs capitalized on their next chance when Childs dashed into the endzone untouched for the score. Junior placekicker Dennis O'Flynn drilled the extra point attempt through the uprights, and the Chiefs led 7-0 with 1:07 remaining

in the first quarter.

The Chiefs powered as close as the East 33 and 34 on two separate drives prior to their touchdown, but a wet and slippery ball caused Canton to fumble both threats away.

Poor field conditions contributed to more problems for both offenses in the second quarter as neither teams were able to produce a scoring drive on the muddy turf. The half ended with the Chiefs out in front, 7-0.

In the third quarter, the Panthers began their game-winning 63-yard touchdown drive following the opening second-half kickoff.

East moved the ball to the Canton 21 on five straight running plays, but the Chiefs were penalized for unspottedmanlike conduct, putting the ball at the Canton nine-yard mark.

Two plays later, the Chiefs were charged with another penalty when one of their players cut through the endzone to leave the field moving the ball from the five to the Canton three-yard line.

Doug Tankersley then took the ensuing play and burst into the endzone from two yards out for the touchdown. The Panthers successfully completed a two-point conversion when Bonner took a pitch from quarterback Bob Nelson and stretched his way across the goal line for the score, giving East an 8-7 margin with 6:37 remaining in the third quarter.

"Our defensive players, substitutes, and offense all did a fine job, and you can't complain about that," said Barr. "All season it's just that we haven't been able to get enough points on the board to win."

Canton will make one more effort to add a victory to its 1-7 season on Friday in a home game against Belleville as its season closes. Kickoff time will be at 7:30 p.m.

# Cruisers dump Belleville

The Plymouth-Canton Swim Club (Cruisers) gained a win over Belleville last week scoring 325 points to Belleville's 195.

First place finishes in the relays included the boys eight and under 100-yard medley team of Jamie Sanderman, JJ Schwinn, Chris Elliott and Patrick Vesnaugh with a time of 1:37.5.

Nicole Helfinger, Tracy Stewart, Marcy Brewer and Kellie Adamczak teamed to win the girls eight and under 100-yard race with an effort of 1:41.3.

Kevin Stackpoole, Jim Gallagher, Jim Riemenschneider and Scott Swartzwelter won the 200-yard race for boys 9-10 years, with a time of 2:45.5, while the girls 9-10 team also won their race. The foursome include Kellie vesnaugh, Erin Olson, Tracy Meszaras and Sue Schendel and had a time of 2:56.9.

Minor Gupta, Sue Bonnett, Kelly Lingerfelter and Lindsay Olson teamed to win the 200-yard race for girls 11-12 with a time of 2:35.5.

The boys 13-14 age group also won a 200-yard medley race. The quartet include Mike Sherwood, Eric Kleinsmith, Jim Dillon, and Bob Bowling. They clocked 2:06 in the race.

The girls 13-14 team of Theresa Schaffer, Kim Elliott, Laura Wochna and Kara Stella teamed to win their 200-yard race with a time of 2:14.8.

Matt Wisniewski, Pat Vesnaugh, Schwinn and Chris Elliott teamed to win the eight and under boys 100-yard freestyle race with a time of 1:21.2.

Kelly Riske, Marcey Brewer, Helfinger

# Kelly Heaton plays volleyball for NMU

Kelly Heaton, a 1979 graduate of Canton High, has been making a contribution to the Northern Michigan University Women's volleyball squad this year.

So far, Northern has compiled an 11-10 record in national competition.

Heaton, who earned four letters while at Canton and was an all-area player in both

and Adamczak teamed to win the girls version of the eight and under freestyle race. They clocked 1:27 over the 100-yard course.

The 9-10 girls 200-yard race was won for the Cruisers by Schendel, Erin Olson, Katie Vesnaugh and Meszaras with a time of 2:33.

Cindy Elliott, Lindsay Olson, Gupta and Lori Schaffer teamed to win the 200-yard race for 11-12 girls. They had a time of 2:11.7.

Both the 13-14 year old boys' and girls' 200-yard teams were also victorious. They included the same members as in the medley races for those ages.

In individual races, Chris Elliott was first and Matt Wisniewski was third, in the boys eight and under 25-yard race, while Kelly Riske and Helfinger were first and second in the girls race.

Mickey Adamczak and Swartzwelter were first and second in the 50-yard, 9-10 year old, race, while Tracy Meszaras and Jennifer Anderson were first and second in the girls race.

Don Harwood won the 11-12 age, 50-yard race with an effort of 26.5 seconds.

In the girls 11-12 race, Lori Schaffer was first, Cindy Elliott was second and Michelle Stackpoole was third.

Mike Harwood and Jim Dillon were first and third in the 50-yard race for boys 13-14, while Kim Elliot and Theresa Schaffer were second and third in the girls race.

The Cruiser will face Willow Race next Monday (Nov. 1) at home. The meet begins at 6:30 p.m.

basketball and track has won a spot as a front line player for NMU.

Last year, Heaton earned a first year varsity letter with the team. The six-foot, 170-pound sophomore will be with the team when they enter regional competition early in November.

Starting This Halloween...  
Unbelievable Savings!  
at

*Master  
Lighting Inc.*

5848 North Sheldon  
Canton, Mich 48187  
459-3170

40% • 50% • 60%  
OFF List Prices

- Outdoor Lanterns, Post Lights
- Chandeliers and Foyer Lighting
- Bath and Vanity Lighting
- All Quality Lighting by Thomas, Quoizel, American Lantern, and many more!

• Two Weeks Only •



Store hours:  
Mon-Wed 10-6  
Thur & Fri 10-8  
Sat 10-5



The doorbell rings...

a wholesome, delicious pizza from Domino's Pizza. Every hobgoblin knows that Domino's Pizza is concocted from the choicest ingredients and baked under the light of the full moon to be delivered by our special messenger to every spirited ghost in the land. Give us a call, and listen.

Our drivers carry less than \$10.00



**\$1.50**  
\$1.50 off a large 16" Deluxe pizza.  
One coupon per pizza.  
Expires 11/15/80

Fast, free delivery  
7262 Sheldon  
Phone: 453-3040





# Amway® is Families

... family teams who build a business as Independent Amway Distributors by bringing exceptional products and service to North American homes. Call

**Ed & Sharon Hood**  
455-3366



Shop without going shopping... with your neighborhood Amway Distributor.

## LEARN TO DRIVE



New Teen Classes  
Starting Now at the  
Plymouth Cultural Center  
State Approved & Licensed  
**MODERN**  
SCHOOL OF DRIVING  
326-0620 or 476-3222

# Rock cagers win 2 Sub. 8 struggles

Salem's girls basketball team gained two more Suburban Eight League victories beating Dearborn and Allen Park last week to keep the Rocks hopes for a league title still alive.

Against Dearborn, last Thursday, Salem won 34-20 behind some consistent defensive play.

"They (Dearborn) tried to control the ball a lot. It was a ball control type of game, but we were pretty consistent throughout the whole game on defense," said Salem coach Bob Blohm.

Salem started the game with a 12-point burst in the first quarter compared to Dearborn's eight points. In the second quarter, however, things wouldn't go right for Salem and they added just two points to their tally while Dearborn had seven. Halftime score was 15-14, Dearborn.

"We had a good first quarter and I think our second quarter was exactly the same as the first but the ball wouldn't go in the net," said Blohm. "We had some tremendous shots in the quarter that wouldn't fall in."

In the third quarter, Salem scored 10 points and Dearborn had two. The Rocks then added 10 points in the final period compared to Dearborn's three for the win.

"Our third and fourth quarters were good, consistent quarters," said Blohm.

Salem was paced offensively by Carol Ross with 10 points. Elieen Moore and Cheryl Sobkow contributed eight points each for the Rocks.

Earlier in the week, Salem dumped Allen Park 48-18.

"We did dominate the game, but the first half was fairly close and Allen Park has actually improved a lot this year," said Blohm. "We had good pressure defense and took away from what they wanted to do."

"We weren't sensational but we were consistent and we got good play from our support players," continued the coach.

Salem opened the game with 13 points in the first quarter and 10 more in the second. Allen Park scored nine and seven in the first half.

The second half was all Salem's as the squad added 12 points in the third quarter and 13 in the fourth. Allen Park had two points in the third quarter and failed to score in the final period.

Moore paced Salem with 13 points, while

## Chief cagers gain 2 league wins

"We made them turn the ball over a lot in both games," said Canton girls' basketball Coach Mike McCauley, after the Chiefs collected Western Six victories over Northville, 84-45, and Waterford Mott, 59-44.

Canton now posts a perfect 6-0 league record along with an impressive 12-2 overall showing.

On Thursday against Northville, Canton led 18-13 at the end of the first quarter and carried a 15 point, 43-28, margin into the locker room at halftime.

In the third quarter, the Chiefs padded their lead 58-36, and pulled further out in front by outscoring the Mustangs 26-9 in the final period.

Pearl Cunningham led Canton's charge by netting 26 points. Other Chief players scoring in double figures were Reggie Ruggiero and Cyndi Sovine collecting 13 points apiece followed by Jean Timlin with 11 points and Colleen Crissey with 10 points. Jackie Nixon led the Mustangs with 23 points.

Canton took advantage of 19 Northville fouls by connecting on 17 of 25 free throws,

Sobkow had 10 and Jan Mackenzie had eight.

"From the league standpoint yeah the two wins were really good to have. It's good to have that," said Blohm. "We have two more league games before meeting Bentley again and we need wins."

On of those league struggles will be tomorrow when the Rocks face Belleville at home. Varsity game time is 7:30 p.m.

while the Mustangs hit 12 out of 19 foul shots, as the Chiefs were charged with 19 personals.

"Our shooting percentage from both the court and foul line was extremely tough," said McCauley. "Most of the players' individual field goal percentages this year are near 50 per cent and our free throw per cent is around 75 per cent, which has been one of the major factors for our success this season."

Earlier in the week, against Mott, another unbeaten team in the Western Six, Canton took off to a 14-8 first quarter lead and then led 27-20 at the intermission.

The Chiefs took command in the second half by outscoring the Corsairs 32-24, to help retain their unbeaten Western Six status.

Timlin sparked the attack for Canton with 15 points, and Ruggiero added 14 points. Cunningham and Crissey followed with eight points each.

The Chiefs next battle will be tomorrow night in a league clash against Walled Lake Western at the Walled Lake gymnasium. Game time will be at 7:30 p.m.

## Mini-Mite skating clinic

An instructional clinic for young hockey players (four years and older) will be conducted every Saturday this winter at the

Plymouth Cultural Center.

The fee is \$2 for each hour session. Time is 4 p.m. The clinic is sponsored by the Plymouth Hockey Association.

# thanks!

When money is tight, it's even more important that you not waste any of your advertising dollars.

Place your ad where you'll get readership, impact, response.

# The Community Crier

Call your consultant now to plan your  
Holiday Season Advertising.

453-6900



**DAVE'S CARPET SERVICE**  
640 Starkweather  
PLYMOUTH, MICHIGAN 48170  
Phone 459-3090

The Community Crier  
1226 S. Main Street  
Plymouth, Michigan 48170

To The Editor and Staff,

October 21, 1980

We the owners of Dave's Carpet Service would like to express our appreciation and satisfaction of our last advertisement in the recent Apple Festival section of your newspaper. The ad created more business for us than ever before. We had people standing in line on our cleaning appointments. We also had ten messages on our answering service, before we opened the phone never stopped ringing all day. We booked totally over 50 appointments. In fact people are still reading the ad and calling us, to see if we can extend the special.

Thanks to all of you and especially to our advertising representative, the best ever Fran Hennings.

Dave and Karen Rotarius  
*Dave and Karen*  
Dave's Carpet Service

# Salem swimmers beaten

Salem's girls' swim squad suffered its third loss of the season as Dearborn used its strength and a four-lane pool to win the Suburban Eight League match-up, 53-30.

"They have a four-lane pool so we were unable to use our depth and besides they are a tough swim team and they scored a lot of firsts against us," said Salem Coach Chuck Olson. "We swam pretty well. I can't complain about our times. They were consistent."

B. J. Bing scored Salem's only first place of the meet, winning the 100-yard butterfly with an effort of 1:12.7.

# Chief swim team loses

The Canton girls' swim team suffered a tough defeat to Northville 50-30 Thursday night to lower its Western Six League record to 2-2 and 5-6 overall. The Mustangs, who are in first place in the league, have been responsible for both Chief setbacks this season.

The meet, however, didn't end without its bright spots for Canton as two school records were set in diving. Senior Chris Wennerberg broke her own record of 199.95 points by picking up 214.65 points against Northville, for Canton's lone first place finish.

Shaun Neville posted a new freshman diving record by collecting an impressive 150 points to shatter Wennerberg's old record of 142 points.

"Overall, it was a good meet even though we lost," said Canton Coach Mark Griffith. "It was a strong improvement over our last dual with Northville several weeks ago."

"A lot of our swimmers had their best times and we had two school records set in diving which is very promising. Our strong performances mean that we should do well in the league meets and state finals."

The Chiefs' best showings in the swimming events were second place finishes by Bronwyn Fitzgerald in the 100-yard breast stroke, 1:23.1; Kim Massey in the 100-yard backstroke, 1:09.3 and 200-yard individual medley, 2:25.9; Missey McMurray in the 100-yard freestyle, 1:00 and 50-yard free-

style, 27.3; Mary Reardon in the 500-yard freestyle, 6:23.1; Kathy Stern in the 100-yard butterfly, 1:35.5; and Ellie Wagner in diving with 181.7 points.

Canton also received seconds from Debbie Dickinson, Reardon, Janet Powell, and Massey in the 400-yard freestyle relay, 4:18.7; and Karen Mullen, Dawn Mullen, Lisa Dunbar, and Kelly Salyer in the 200-yard medley relay, 2:29.9.

Other showings were third-place finishes from Reardon in the 200-yard freestyle, 2:21; Powell in the 50-yard freestyle, 29.4; Lisa Godre in the 100-yard butterfly, 1:27.3; Dickinson in the 100-yard freestyle, 1:05.0; and Salyer in the 500-yard freestyle, 6:59.0.

The Chiefs are now ready to face league rival Farmington Harrison in a home meet tomorrow night starting at 7 p.m.

# Punt, pass, kick this weekend

Canton's Parks and Recreation Department is sponsoring the first annual Punt, Pass, and Kick competition on Nov. 1 at Griffin Park.

The competition is open to all age groups both boys and girls and will be conducted at Griffin Park from 10 a.m.

A registration period will be held at 9 a.m. on that day for those that wish to participate.

For further information, call the Recreation Department at 397-1000.

Other than that effort, the Rocks scored a lot of second and third places.

Linda Wochna, Corinne Cabadas, Amy Dunn and Terri Eudy teamed for a second in the medley relay with a time of 2:07.2, while Debbie Darlington, Linda Nelson, Bing and Julie Cabadas were third with a time of 2:12.

Eudy was also second in the 100-yard freestyle, 56.4 seconds and second in the 200-yard freestyle, 2:08.

Sally Weimer was third in the 200-yard individual medley with a time of 2:34.3, while Corinne Cabadas was third in the 50-yard freestyle, 28.1 seconds.

Patti Larson was second in the diving competition with 184.6 points, while Ruth Ettinger was third second in the 100-yard butterfly with an effort of 1:19.3.

Kelly Brandt was second in the 500-yard freestyle, 6:11.3 and Weimer was third, 6:16.4.

Wochna was second in the 100-yard backstroke, 1:11, and Darlington was third just one-tenth of a second off Wochna, 1:11.1.

Corinne Cabadas was also second in the 100-yard breast stroke with a time of 1:17.2.

In the freestyle relay, Julie Cabadas, Brandt, Dunn and Nancy Lazarus teamed to finish second with a time of 4:16.2, while Bing, Ellen Wall, Wochna and Weimer were third with an effort of 4:24.9.

Salem is now 7-3 overall and according to Olson could be 7-4 after tomorrow's meet with Livonia Stevenson. "Stevenson has one of the top five teams in the state. It will be tough for us" said Olson. That home meet starts at 7:30 p.m.

# West. Sub. soccer

With two weeks remaining in the Western Suburban Soccer League, Plymouth teams are still fighting for positions along with teams from Livonia, Northville, Farmington and Westland.

Plymouth 1 in under 10 girls division one has a 5-2 record for second place, while Plymouth 3 is 3-4.

In division two of that age, Plymouth 2 is 4-2-1.

Under 12 girls division one has Plymouth 3 with a 2-5 record, while division two has Plymouth 1, 4-2-1, and Plymouth 4, 3-4, and division three has Plymouth 2 with a 3-1-2 record.

In under 14 girls division A, Plymouth 1 still has not won a game in seven outings, while division two of that age has Plymouth 1 with a 2-3-2 record and Plymouth 2 with a 1-6 mark.

Under 16 girls has Plymouth 1 with a 4-2-1 record and in under 19 girls Plymouth 1 is undefeated with a 6-0-1 record.

Under 10 boys division one has Plymouth 11 with an 0-6-1 record; division two has Plymouth 1 with a 5-0-2 record, Plymouth 5 with a 3-2-2 record and Plymouth 2 with a 2-4-1 mark.

In division three of that age group, Plymouth 8 is 2-4-1; division four has Plymouth 9 with a 3-2-2 record, Plymouth 12 is 1-4-2 and Plymouth 10 is 0-6-1; division five has Plymouth 3, 6-1, Plymouth 4, 4-2, and Plymouth 7 with a 2-2-2 mark.

Under 12 boys division one has Plymouth 1 with a 2-5 mark; division two has Plymouth 3 with a 5-1 record, Plymouth 4 with a 5-1 mark; division three has Plymouth 6 with a 6-0-1 record and Plymouth 7 with a 3-3-1 mark; division four has Plymouth 10 with a 6-0-1 record and Plymouth 5 with a 3-3-1 record.

In division five of that age, Plymouth 9 is 4-2-1 and Plymouth 2 is 0-6-1, while in division six, Plymouth 11 is 4-3 and Plymouth 8 is 1-4-2.

Under 14 boys division one has Plymouth 4 with a 4-0-3 record; division two has Plymouth 2 with a 2-4-1 record; division three has Plymouth 5 with a 5-2 record; division four has Plymouth 1 with a 4-1-1 mark.

Division one of under 16 boys has Plymouth 1 with a 4-1-2 record and division two has Plymouth 2 with a 3-2-1 record.

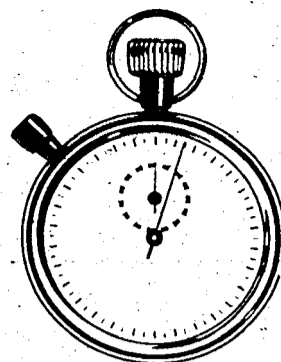

IN ONLY ONE  
MINUTE WE WILL  
GIVE YOU 100  
PRINTED COPIES  
AT  
**Big Red Q**  
100 PRINTED \$4<sup>28</sup>  
COPIES

810 South Main  
Plymouth

459-5750

# WILD BIRD FEED & FEEDERS

Triumph Wild Bird Seed

25lb.	50lb.
\$4 <sup>95</sup>	\$8 <sup>95</sup>

Jolly Wild Bird Seed

25lb.	50lb.
\$4 <sup>95</sup>	\$7 <sup>95</sup>

SUNFLOWER SEED

5lb.	25lb.	50lb.
\$1 <sup>95</sup>	\$8 <sup>95</sup>	\$15 <sup>95</sup>

SUET CAKES 11oz. \$1<sup>10</sup>

50 Types of  
**FEEDERS**  
In Stock



**SAXTONS**

587 W. ANN ARBOR TRAIL  
PLYMOUTH • 453-6250

**GARDEN  
center inc.**

# Home Improvement Special



- ADDITIONS
- GARAGES
- DORMERS
- CEMENT
- SIDING
- AWNINGS
- KITCHENS
- REPLACEMENT WINDOWS
- BASEMENTS
- GUTTERS
- ATTICS
- STORMS—SCREENS

Deal Direct with the Owner  
**FREE ESTIMATES**

**Gj Construction**

453-1590

LICENSED

INSURED



\$3.50 for the first  
10 words, 10¢ each  
additional word

# Crier classifieds

Deadline:  
Monday 5 pm  
Call 453-6900

PG  
37  
THE COMMUNITY CRIER: October 29, 1988

## Lessons

Piano, organ, vocal. Mr. Ronnie Phillips  
20 years experience, formally with An-  
derson Music. 453-0108 lead-sheets &  
arrangements.

Piano lessons -- Bachelor of Music degree.  
Experienced. Dan Hiltz, 455-9597 or 349-  
9420.

Qualified guitar instructor at Jerry's 453-  
2744.

## Storage

Western Wayne County's finest mini-  
self-storage. Servicing the greater Ply-  
mouth-Canton area. Storage Unlimited.  
459-2200.

## Lawn Services

MILLERS LAWN SERVICE FALL CLEAN  
UP. Trim bushes, edge sidewalks and  
drives, rototilling. 453-9189.

## For Rent

New Home in Northville - 4 bedrooms,  
2½ baths, \$95.00 mo., 2 car attached  
garage. 632-5464.

## For Rent

RESPONSIBLE working people to share  
spacious, luxurious flat one ½ blks. from  
town on W. Maple. Maximum of 3 people,  
215.00/per mo. per individual plus util-  
ities, no pets, 453-1007.

Beautiful furnished Country home. Avail-  
able Nov. 30 -- April 30, \$300.00 mo. +  
utilities, Ply. Area, 453-6945.

Plymouth one bedroom efficiency -- stove  
refrigerator, carpeting, \$250.00 per month.  
All utilities included. Single, female pre-  
ferred, 455-0391.

Plymouth - one bedroom & 2 bedroom  
apartments available immediately. Stove,  
refrigerator, carpeting, drapes, air con-  
ditioner \$255.00 and \$265 plus utilities.  
453-8194 after 3 p.m.

## Office For Rent

PLYMOUTH-IN-TOWN-LOCATION new  
front, new pella & bay windows, new fur-  
nace, new wall to wall rug thru out; 3  
office Suite, sm. equipped kitchen & bath-  
room -- 1,000 sq. ft. 395.00/per mo. Oc-  
cupancy Nov. 7 or before. 453-1007.

## Condos For Sale

FOR SALE PLYMOUTH'S HIGHLY  
DESIRED "WEDGEWOOD" CONDO.  
Luxurious, original owner, 3 BEDROOM  
RANCH has 2 baths, liv. room with wood  
burning fireplace, formal dining room,  
bay-windowed breakfasting in adjoining  
fully equipped kitchen, 1st floor laundry,  
full basement, attached 2 car garage.  
You'll be pleased to find wood casement  
windows, custom moldings, 6 paneled  
doors C/A, 2 landscaped sun-splashed  
patios. \$105,000. Call 453-9367 after 7  
p.m.

## Vehicles For Sale

74 Grand Torino Elite -- PS-PB, Air, new  
trans, brakes, radiator, exhaust, runs  
very good, some rust; uses regular gas,  
\$800.00 or best offer. Call Tom, 453-3477.

'76 Torino Starsky & Hutch paint job  
351, 2 barrel, headers, AM-FM & 8 track  
\$1600.00 or best offer, 459-6326.

1976 Monte Carlo, great condition, beauti-  
ful. 455-2133.



PLYMOUTH--NORTHVILLE  
455-5200

### TRAFFIC IS ALL CLEAR

On these Sparkling new Model Homes. 5%  
Land Contract complete in Design, Beauty,  
and Extras. No Detours when it comes to  
Details. Call Tony Kolman at 455-5200.

### HIGHWAY TO HAPPINESS

This 3 Bedroom Brick Ranch is a Deluxe  
Thru-Out. Joanne Tatum will share Details  
with you on this plump Package. \$41,900.  
455-5200 (PV1)

### YIELD AT THE CROSSROADS OF BEAUTY

Every Corner of this 3 Bedrm. Colonial is  
warmly treated with the Finest Interior. De-  
clared as Maintenance Free Exterior is  
Simply Serene. \$75,900 Call 455-5200. (PP8)

### PLYMOUTH IS NOW OFFERING

This Precious, Heart Winning Home. 3 Bed-  
rooms, Fresh and Pretty Interior. Location,  
Home & Neighborhood is much more than  
Desirable. \$65,700 Call 455-5200 (PA6)

### GUIDED TOUR AVAILABLE

Thru this 4 Bedroom home that is Ab-  
solutely surrendered to Pleasing you. Filled  
with Vibrant Earth-Tones, Huge Closets,  
many great Assets. \$77,400 Call 455-5200  
(PP9)

Professional Realtors Serving the Suburbs since 1948

## AUTOMOTIVE

# UP- DATE

459-9744  
459-9745

### ELITE COLLISION

Bumping and Painting  
Insurance Estimates

### FREE LOANERS

JIM

936 Ann Arbor Rd.  
Plymouth

NOTHING BEATS  
THE OLD FASHIONED  
WAY  
of  
Buffing & Polishing  
Handwaxing &  
Reconditioning



Quality service since 1959

### DICK'S CUSTOM AUTO CARE

Call for  
Appointment  
455-2660

9165 General Court  
(off General Drive)  
Plymouth

### Tom's Custom Auto

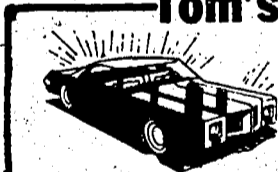

Body Repair  
and  
Painting  
Inc. Imports

Reconditioning & Waxing  
Interior & engine cleaning  
453-3639 770 Davis  
(old village, Ply.)

## Winterize Special

# \$ 10<sup>95</sup>

expires Oct 31, 1980

With this ad

# RED HOLMAN

# TOYOTA

35300 Ford Rd -- Westland.  
(At Wayne Rd)  
Westland  
721-1144

Includes:  
Antifreeze Changed  
Visual Inspection of  
Heating & Cooling System

# Crier classifieds

Reach the people  
in YOUR community

## Call: 453-6900

or clip & mail this form today!

Write Your Ad Here:

---

---

---

---

---

---

---

---

Mail to:

The Crier  
1226 S. Main St.  
Plymouth, Mi. 48170

Your Name.

Phone

Address

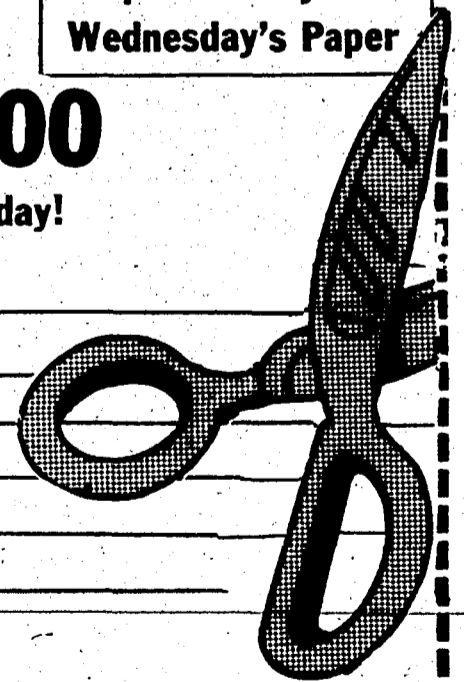

\$3.50 for the first  
10 words, 10 each  
additional word

# Crier classifieds

Deadline:  
Monday 5 pm  
Call 453-6900

## Lost & Found

Found 1 pr hard contact lenses by the back door of Beautiful People, also 1 pr of sunglasses. Call Beautiful People, 459-2880.

## Curiosities

Gun and Knife Show: Nov. 8 & 9, 8 a.m.-4 p.m., Ypsilanti - I-94 at Huron St. exit -- follow signs.

Witches and goblins storytime and hot cider 8:00 p.m. Halloween night. Plymouth Book World, Forest Place 455-8787.

### EYE CATCHERS

Misties, candlelights, environmentals, and so much more to add that special touch to your wedding photography. Rawlinson Photography, 453-8872.

### SISTER ANGELA READER & ADVISOR

She can help you on all problems of life. She has helped many. Business, Love, Marriage, Health, Divorce, lost nature, bad luck of all types. (All readings private and confidential) One visit will convince you she is a gifted reader. Six days a week. 9 a.m. till 6 p.m. 261-5669. Also handwriting analyst.

## Curiosities

Willy -- love your bumper stickers.

Phyllis -- good luck on your mid-term!

Looking for models for Nov. 3rd all day or evening. Hair cutting & styling. For more information call Beautiful People Hair Forum, 459-2880.

Mary, what was your purse doing swimming in the lake on a beautiful fall morning?

JESSICA digs Dick & Joan Palmer's farm in Canton as the youngest archaeologist in Mrs. Welsh's Allen School history project.

TUCKER didn't eat prime rib, stuffed trout and artichokes at Herb's Place -- but she wished she had! What a meal!

DOUG JOHNSON is older! Happy birthday.

PLEASE VOTE TUESDAY!

DIANE - you're welcome to use my hideout any time. Just stock it with peanut butter.

HURRAH for the Canton library opening.

## Curiosities

KATHY WEBBER has a new job doctoring horses.

FLASH, you should've bought the light house.

\$\$ Attention: Bingo, Horse, and Lottery player! Steinbeck and Stephenson astrology & numerology consultants will calculate your "very own personal lucky numbers." We will also include your most favorable days to play them. Here is your chance to change your luck by sending full name, address, date of birth & time plus \$5 to: Steinbeck & Stephenson, P.O. Box 7636 Ann Arbor 48106. "Don't let lady luck pass you by."

NANA has a new furnace, we hear. Have a toasty winter.

IF YOU believe Steve Manfield's story about what happened to his arm, please call immediately about this piece of Florida land with a mountain view. "Tripped over my dog," he sez.

Thank you to the 2 Gentlemen who helped me in front of K-Marts on Monday night, thank's for the quarter and thanks to the other for the use of your jack.  
(The lady with the yellow VW)

## Curiosities

Nancy Trainor is how old now?! Happy Birthday!

Your friends

Princess, the feeling is mutual.

Marv, Pops, Scott, Scampie

DOUG JOHNSON is older now!

THANKS for the new snowsuit Grandpa Don and Grandma Margaret.

Brian & Kim -- lovely wedding - but some strange seating arrangements at the reception. . .

Becky, are you sure you're strong enough to pull that chain?

Lunch at Chez Robert was fun, I'm still hungry. Ze Blonde

GOOD LUCK: Arp, Arp! Ed

HAPPY BIRTHDAY Aunt Dot! Sorry I was asleep and missed the call . . . I was pooped out from potty training with Dad all day. Jessica

LINDSAY ELIZABETH HYLAND is here! Congratulations Barb & Mark

JOHN FLODIN grows great green gourds.

## HOT OFF THE PRESS...

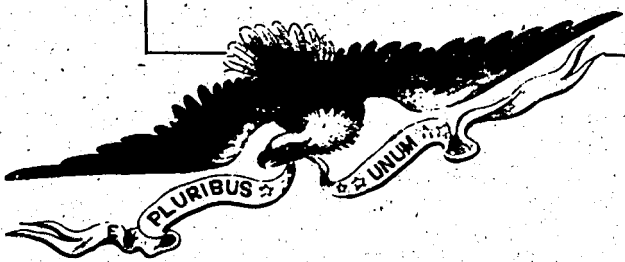

Complete  
election coverage  
in next Wednesday's



Community  
**Crier**

The Newspaper with Its Heart  
in The Plymouth-Canton Community

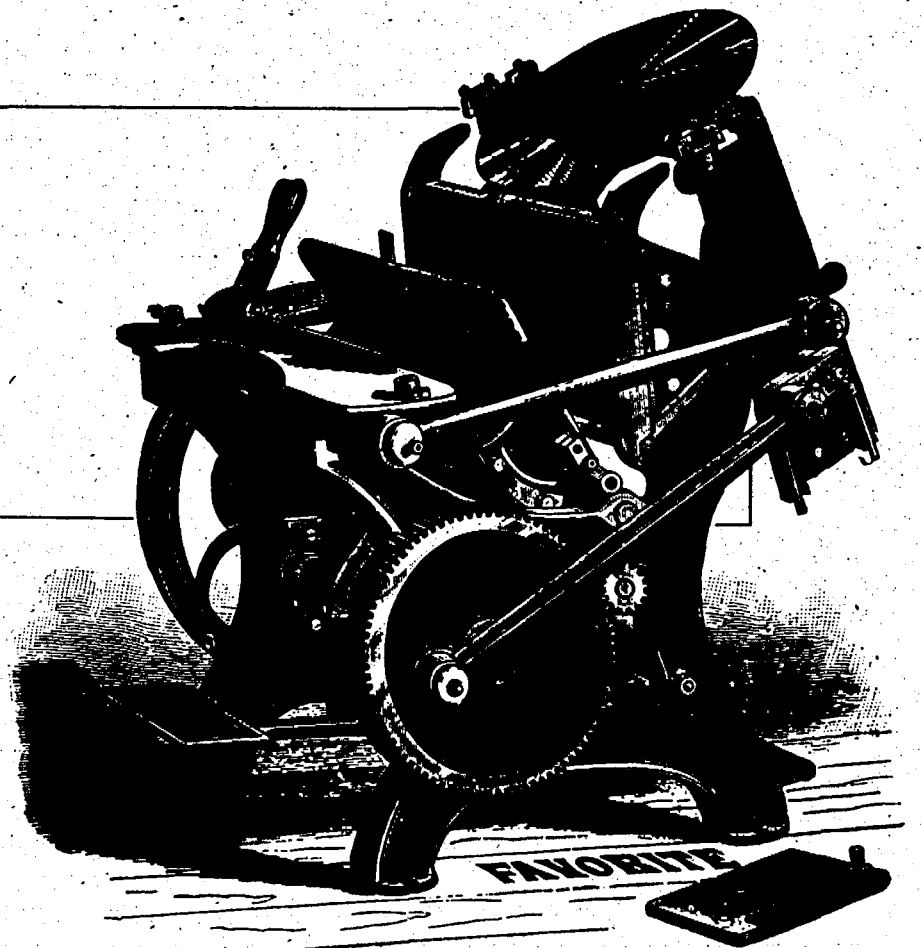



Help is just  
a phone  
call away

# Dial-It Shopping

## ALARMS

**MIDWEST ELECTRONIC SECURITY**  
36343 Ford Rd.  
Westland  
721-3894  
Commercial and residential Security System installed  
Auto Alarms • Keyless push button alarm system • Free estimates

## APPLIANCE REPAIR

**BILL & ROD'S APPLIANCE**  
15076 Middlebelt  
Livonia  
425-6040  
• Maytag Dealer • Repair all makes & models major appliances  
• Parts available • Whirlpool • Maytag • Kenmore • G.E.  
• Used Appliances.  
Mon. thru Sat.

## AUTO REPAIR

**DENNY'S SERVICE**  
1008 Starkweather  
Plymouth  
453-8115  
Front end work • Tune Ups • General repair • Certified Mechanics • \$28.00 Computer Hook-up plus 4 minor adjustments.

## BAKERY

**MARIA'S ITALIAN BAKERY**  
115 Haggerty - 981-1200  
38411 Joy Rd. - 455-0780  
• Square Pizza • Hot Italian Bread • Sausage • Baked Goods • Cannoles • Cake • Italian Lunch Meat • Beer • Wine.

## BATH BOUTIQUE

**FAMILY BATH BOUTIQUE**  
895 Wing St.  
Plymouth  
459-1680  
• Remodeling • Repairs • Bath Accessories • Medicine Cabinets • Vanities • Bath Carpeting • Shower Curtains • Wicker & Wood Accessories.

## BEAUTY SALON

**DD HAIR FASHIONS**  
44706 Ford Rd.  
Canton  
455-9330-453-6540  
455-9331-453-6640  
Specializing in  
• Perms • Precision & Permetric Hair Cuts • Manicures  
Total Redken Hair Salon

## BOOKSTORE

**PLYMOUTH BOOK WORLD**  
2 Forest Place  
455-9787  
844 Penniman  
455-6600

Expand your horizons • Read a book today • Unique childrens selection • Discriminating Magazine corner • Refreshingly different cards & gifts

**LIST YOUR  
BUSINESS HERE  
453-6900**

## BREAD & POP DEL.

**DOSSIN'S SODA**  
904 Starkweather  
Plymouth  
459-HOME  
Free Horse drawn delivery weekly to your door of • Pepsi • Coke • Day Old Bread  
Or Pick up at Store

## BRIDAL SALON

**GENEVA'S OF PLYMOUTH**  
17 Forest Place  
Plymouth  
455-4445  
Wedding Gowns • Accessories • Cocktail Dresses and Prom Gowns • Appointments Available  
Mon.-Tues.-Wed.-Sat.  
10:00-6:00  
Thurs.-Fri. 10:00-9

## CHILD CARE

**HUGS AND KISSES CHILD CARE & LEARNING CENTER**  
104 N. Main St.  
Plymouth  
459-5830  
Year round Pre-School • Ages 2½-9 yrs • Full-time, Part-time, Drop-in, E.S.Y. Programs  
• Licensed, Certified • Field Trips • Summer Camp 7 am 6 pm.

## DANCE INSTRUCTION

**MASTERS OF DANCE ARTS**  
6034 Sheldon Rd. (at Ford)  
Harvard Square  
455-0720  
Ballet • Tap • Jazz • Gymnastics • Pre-School • Hawaiian • Baton • Modeling • Singing • Drama

## FIREPLACE SHOP

**VILLAGE FIREPLACE**  
"The Alternate Energy Center"  
6074 Sheldon Rd.  
459-3120  
• Complete home fireplace center • Zero clearance fireplace units • Inserts • Airtite wood stoves • Furnace add-ons • Complete line of accessories.

## FIREWOOD

**SUBURBAN FIREWOOD**  
46875 Newton, Canton  
495-1311  
**FIREWOOD**  
Split-mixed hardwoods well seasoned. Jonsored's and Olympic Chain Saws. A complete repair service with a full line of accessories.

## FLORIST

**HEIDE'S FLOWERS**  
Ann Arbor Trail at Harvey  
453-5140  
Largest selection of fresh, dried & silk Flowers. Also featuring Wicker, Stuffed Animals, Brass & Pottery. Daily Deliveries.

## FURNITURE

**LAUREL FURNITURE**  
Complete home furnishings. Large selection of baby furniture and clocks. Quality furniture moderately priced. Free delivery.  
584 W. Ann Arbor Trail  
Plymouth  
453-4700

## FURNITURE REFIN.

**FURNITURE REJUVENATION UNLIMITED**  
Old Village - Plymouth  
882 Holbrook 459-4930  
Natural & Painted Finishes • Wood Repair • Woven Seats • Hand Stripping • Wicker Repair.

## GARAGE BUILDERS

**RAY R. STELLA CONTRACTING INC.**  
747 S. Main Plymouth  
459-7111  
Each of our garages built to your particular need and home style.  
• Attached or free standing • Free Estimates • Financing.

## GROOMING & BOARD

**TOWNE & COUNTRY KENNELS**  
47857 Cherry Hill Rd.  
Canton  
453-2790  
• All breed grooming & boarding • Reasonable rates • Veterinarian Recommended  
"Let us pamper your pet"

## HALL FOR RENT

**VFW 6695 PLYMOUTH**  
1426 S. Mill St.  
Plymouth  
455-8950  
Wedding, Graduations, Anniversaries, Meetings, Fund Raisers, UNDER NEW MANAGEMENT.

## HEATING

**PUCKETT CO.**  
412 Starkweather  
Plymouth  
453-0400  
Air conditioning • Heating • Plumbing • Sewer cleaning • Visa • Master Charge • Night & Day Service • Licensed • All Areas.

## HOME IMPROVEMENT

**RAY R. STELLA CONTRACTING INC.**  
747 S. Main • Plymouth  
459-7111  
Complete Remodeling Service • Kitchen planning & Design • Additions • Family Rooms • Sun & Garden Rooms • Porches • Free Planning & Estimates • Full Financing

## INSULATION

**AIR TITE INSULATION**  
882 N. Holbrook  
Plymouth  
453-0250  
Save on the cost of heating-cooling. Fast, professional installation... "your comfort is our business."

## INSURANCE

**ALLSTATE INSURANCE**  
Lets Compare, Maybe I can save you some money  
• Auto • Home • Life • Business  
Call me & Compare  
Ken Montay-453-7100  
5924 Sheldon  
Canton MI. 48187

## KITCHENS

**ROSEDALE KITCHENS**  
459-2186  
• Custom Designed Kitchens & Baths • Wood & Formica Cabinets • Vanities • Corian Tops • Counter top replacements • Free Design & Estimates. Licensed Builders

## LADIES FASHIONS

**HELEN'S FACTORY OUTLET**  
425 Inkster Rd.  
Garden City, Michigan  
425-8600  
Classic styles and up to date coordinated fashions in sizes 3 thru 46. Tues. thru Sat. 10:5-30 p.m. Thurs. 10-8:30. Closed Monday.

## LAUNDRY

**FOREST LAUNDRY AND CLEANERS**  
585 Forest, Ply. •  
937 Ann Arbor Rd., Ply.  
453-1880  
• Full Service or Self Service • Flat Work beautifully finished • Self serye dry cleaners • Two locations to serve you.

## LOCKSMITH

**THE TOWN LOCKSMITH**  
1270 S. Main  
Plymouth  
455-5440  
Locks repaired and installed. Keys made for residential • Commercial • Cars (American & Foreign) • Combinations Changed house, auto, safes. • Locking Gas Caps

## MATERNITY APPAREL

**MATERNITY VOGUE**  
7353 Lilley Rd.  
Kings Row Shopping Center  
Canton, MI  
459-0260  
Fashion for the price conscious "mother to be." Great selection in all departments. Mastercharge & Visa.

## MEAT MARKET

**PORTER HOUSE MEAT MARKET**  
1058 S. Main  
Plymouth  
455-6770  
Specializing in:  
• Fresh USDA Choice Meat • Freezer Specials • Fresh Seafood • Homemade Sausage • Deli  
Plymouth's Newest & Finest Meat Market

## MUSIC

**ARNOLDT WILLIAMS MUSIC**  
5701 Canton Center Rd.  
Canton, Michigan  
453-6586  
Pianos • Organs • Guitars • Electronic Keyboards • Microphones • Amplifiers • Sound Systems • Sheet music • Reeds Lamps • QRS Piano Rolls • Bench Pads

## PLUMBING

**JOHN J. CUMMING PLUMBING**  
1425 Goldsmith  
Plymouth  
453-4622  
Kohler plumbing fixtures • Residential • Commercial • Repairs • Modernization • Rheem water heaters.

## REAL ESTATE

**REALTY WORLD**  
Wm. Decker, Inc.  
670 S. Main St.  
Plymouth  
455-8400  
"OUR WORLD REVOLVES AROUND YOU."

## RESALE SHOP

**HIDDEN TREASURERS**  
778 S. Main St.  
Plymouth  
459-9222  
Good previously owned Furnishings • Childrens Toys, Needs • Sporting Goods • Lots More.  
Monday-Saturday 10:00-6:00  
Friday till 8:00

## SEWER CLEANING

**FAST EMERGENCY SERVICE**  
261-7688  
Removing Tree Roots From Pipes • Clogged Drains • Flooded Basements • Floor Drains • Main Lines • All Repairs Residential • Commercial

## SHOE REPAIR

**PETE'S SHOE REPAIR & LEATHER**  
322 S. Main  
Plymouth  
453-7779  
• Hand tooled belts • Wallets • Hand Bags • Moccasins • Etc.  
Mon.-Sat. 9-6 pm (Under Def's Shoes)  
"Old Shoes Repaired Better Than NEW"

## SLIPCOVERS

**CUSTOM GALLERY**  
1095 York  
Plymouth  
455-3074  
Custom made slipcovers • Shop at home service • Also: Vertical Shades, Upholstering, Levelor Blinds, Woven Woods • Free estimates • VISA-M.C.

## STAMP & COINS

**PILGRIM STAMP and COINS**  
729 W. Ann Arbor Trail  
Plymouth  
459-5275  
Top prices paid for old jewelry Gold & Silver coins, Type & Proof Coins, U.S. & Foreign Stamps.

## TAXI

**STAR CAB**  
453-2223  
• 24 Hr. Service • Airport Service • Package Pick-up & Delivery:  
Ride a Star Its Better By Far  
Serving Plymouth & surrounding areas.

## WALLPAPER & PAINT

**PEASE PAINT & WALLPAPER CO.**  
570 S. Main  
Plymouth  
453-5100  
Wallpaper • Paint, Custom Mixing • Unfinished Furniture • Olympic Stains • Art Supplies • Window Shades • Complete Decorating needs.



# Pine Tree Plaza

JOY RD. • TWO BLOCKS  
EAST OF I-275  
CANTON

More Space Available  
Call 557-4150  
For More Information

Haggerty Joy Rd. Hix

**HAIR TRENDS**  
Barber Stylist  
**459-0404**

PINE TREE PLAZA WELCOMES

Kenneth, Richard,  
Bob Cantin

## HAIR PRODUCTIONS

Unisex Hair Styling  
OWNER: NANCY DUNFORD  
**459-4545**

**Robert Epstein, D.D.S.**  
**FAMILY DENTISTRY**

Saturday & Evening Appointments  
Available

All insurance &  
Medicaid accepted  
39445 Joy Rd.

Accepting New  
Patients  
455-4070

Dr. James Schelberg  
**FOOT SPECIALIST**  
PODIATRIST - FOOT SURGEON



All Insurances  
accepted  
Mon-Sat and  
Evening Hours

39439 JOY RD.  
E. of I-275 • CANTON **455-0770**

### DR. RAY McCURDY

OPTOMETRIST

U.A.W. Retirees Now Eligible For Eye Exam & Eye Glasses  
Eye Examined • Contact Lenses • In-Office Eyeglass Lab •  
We accept Medicaid and Insurance Payments: Ford, G.M.,  
Chrysler, AMC, Teamsters, R.C.I.A., Sheet Metal.

Canton 39469 W. Joy Rd. **459-6660** 2 OFFICES TO SERVE YOU Westland 2257 S. Wayne **729-7900**

### WE'RE THE NEIGHBORHOOD PROFESSIONALS.™



**BOARDWALK REALTORS, INC.**  
39457 JOY ROAD CANTON, MICH. 48187  
459-3600 or 522-9700

© Licensed Trademark of Century 21 Real Estate Corporation.  
Printed in USA. Equal Housing Opportunity. Each office is independently owned and operated.

### HOMESTYLE FRIED CHICKEN

39485 Joy Rd  
Canton MI

2 Blks E. of I-275  
**459-6420**

15 pcs. CHICKEN  
**\$5.99**

OFFER GOOD WITH COUPON ONLY



**\$100 off**  
ANY LARGE PIZZA  
**459-5680**

Mon-Thurs 4:30 pm-1:30 am  
Fri-Sat 4:30 pm-2 am  
Sun 4:30 pm-12 mid.

### HERITAGE DRY CLEANERS

## 20% off

Regular Dry Cleaning Prices for Incoming Clothes  
Good Oct 29-Nov 3  
39463 Joy Rd • Pine Tree Plaza

**455-7878**

Closed Sunday

## QUIK-PIK

Pine Tree Plaza  
Only

Offer Good thru  
November 2, 1980

FOOD STORES, INC.

"Michigan's Most Convenient Food Stores"

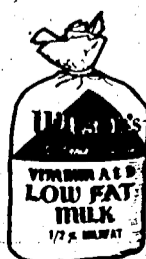

**\$1.59**  
Gal. Pouch

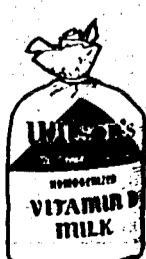

**\$1.79**  
Gal. Pouch



**79¢**  
7 oz  
Bag

**\$1.99 1/2 liter**  
**8 pak**  
plus deposit

