



## Schools may decide millage Monday

Will the Plymouth-Canton schools request additional millage in the upcoming June 11 election and, if so, how much?

That question will probably be answered by the Citizens Bond Advisory Committee when it meets in joint session with the Plymouth-Canton Board of Education on Monday, April 30. The meeting will begin at 7 p.m. in board offices, 454 S. Harvey St.

In related matters, a letter of resignation was presented to the board by Chuck Heidt, former chairperson of the Bond Advisory Committee, at Monday night's board meeting.

Heidt resigned because the committee's work was extremely time-consuming, said Tom Yack, president of the board. Yack said the committee had planned on delivering its final report in March, however that deadline had been extended.

Bond Advisory Committee member Glenn Schroeder was named as the chairperson of the committee after Heidt's resignation.

The committee was formed in November to make recommendations to house students over the next several years because of soaring student enrollments.



Arson suspected in Twp. blaze

"IT WAS DEFINITELY ARSON," said Detective Frank Burton of the Wayne County Sheriffs Department following Monday night's fire at Marcus Sales, 215 Ann Arbor Rd., Plymouth. Fire was reported at 11:45 p.m. and five units from Plymouth Township responded. Fire Chief Larry Groth said the office interior was gutted by fire and there was extensive damage caused by water and smoke. Investigators discovered

a gas can, screwdriver, and hammer on the roof and may have been used to drill through the roof and drop a match into the offices below, said Burton. "It may have been the job of a professional," said Burton, adding the fire is still under investigation. The owner of the building is Marcus Last of Southfield. (Crier photo by Bill Bresler)

## Could heavy metals ruin Canton land?

An information session Monday night on a proposal to bring a huge sewage composting plant into Canton drew many questions from township residents and officials — and left many unanswered.

The meeting of the Planning Commission was attended by about 50 residents, mostly neighbors of the proposed site on Michigan Avenue east of Morton-Taylor.

According to Supervisor Noel Culbert, the biggest unanswered question is whether the plant will contaminate the water table or food chain with toxic chemicals or heavy metals.

"Bi-Products has glossed over this issue," he said. Under the plan by Bi-Products Systems of Michigan, the firm proposing the plant, about 600 tons per day of treated sewage from Detroit will be trucked to the 140-acre site in Canton and bulldozed into piles where it will compost, or cook until the harmful bacteria (Salmonella, for one) are destroyed.

The resulting material can then be used for fertilizer. However, Culbert said he fears that run-off from the com-

Cont. on pg. 9

## Sign ordinance talks to proceed

BY CHAS CHILD

Canton's Board of Trustees voted to suspend discussion of its proposed sign law but it seems the hold-up is short-lived.

The board was scheduled last night to confer with Township Attorney Bert Burgoyne on the matter at its meeting last night, and tonight a special meeting to discuss the ordinance is set.

Why the change of heart? It seems the advice to halt discussion of the ordinance, which would end the present ban on free-standing ground signs, may not have been given in the first place.

Trustee Bob Greenstein persuaded the board two weeks ago to suspend discussion, citing a recommendation he attributed to Burgoyne.

Because the Canton Chamber of

Commerce had earlier threatened to file suit against the present sign law, Greenstein said that Burgoyne had recommended that all discussion on the proposed law be halted.

But Supervisor Noel Culbert said Friday that Greenstein may have "misrepresented" Burgoyne's case. "It seems that Burgoyne didn't tell Greenstein that all discussion of the new sign ordinance should halt," said Culbert. Therefore, his administration scheduled the board to meet with Burgoyne last night and he was expected to give it the go-ahead to discuss the ordinance tonight, he added.

Asked by The Crier on Monday what he told Greenstein, Burgoyne declined specific comment.

"I had a broad-ranging discussion with him (Greenstein), and I don't remember exactly what I said," Burgoyne stated. "Any further comment I'll make will be with my client, the board of trustees."

The proposed sign ordinance would permit businesses to erect free-standing ground signs for identification.

The board has been reviewing the new law, but the Chamber of Commerce, saying that the board was dragging its feet, threatened to sue over the present ordinance which bans free-standing signs.

## Angry with trustees, Police Chief MacGregor resigns

In a surprise announcement last night, Canton Police Chief Walter MacGregor submitted his resignation to the Board of Trustees.

Upset over apparent lack of cooperation from the board, MacGregor said, "In two weeks you can have my resignation. Everytime I try to improve the department, I run into a buzz saw. I have no animosities, and it's for my own health, too. You can work better if you get someone else."

With those words, MacGregor hurriedly left the meeting and Township Hall, visibly upset and angry.

Immediately before the announcement, MacGregor had asked the board for permission to hire a part-time certified patrolman to boost Canton's

Cont. on pg. 30

Special Crier  
Spring Tonic  
section inside

# Y'ALL COME TO OUR OPEN HOUSE

FRIDAY, APRIL 27 & SATURDAY, APRIL 28

**REGISTER FOR PRIZES!**

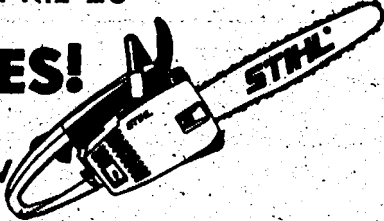
- WIN A ● Stihl O15-I Chain Saw 
- Wondergro Lawn Care Program (\$50 value)
- \$25 Gift Certificate
- Nylon Trimmer

-----COUPON-----

NAME \_\_\_\_\_

ADDRESS \_\_\_\_\_

CITY \_\_\_\_\_ PHONE \_\_\_\_\_

Adults Only- One Per Family. Employees of Saxton's Garden Center and their families not eligible

## NOW IN STOCK:

- ✓ Rose Bushes
- ✓ Seed Potatoes
- ✓ Onion Sets
- ✓ Onion Plants
- ✓ Raspberries
- ✓ Blueberries
- ✓ Blackberries

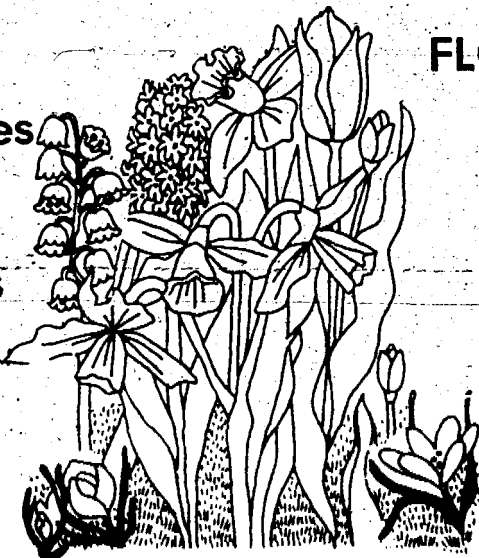

## FLOWER BULBS

- ✓ Gladiolas
- ✓ Dahlias
- ✓ Cannas
- ✓ Cladium
- ✓ Begonias
- ✓ Lillies

Today is your day to save!



Use your Ariens Snowblower to till your garden.

Ariens new attachment fits on your 2, 3, or 5 HP Ariens Snowblower to make a self-propelled rotary tiller.

**\$139<sup>95</sup>**

Or Buy Ariens Little Digger complete unit for ONLY **\$159<sup>95</sup>**

**Ariens** A CUT ABOVE THE REST!

ARIENS - MORE THAN A NAME IT'S A PROMISE

**FOR LESS THAN 1¢ PER SQUARE FT.!**

**wondergro's DELUXE LAWN CARE PROGRAM**

What you do now will make it easier all season long.

## HERE'S HOW IT WORKS

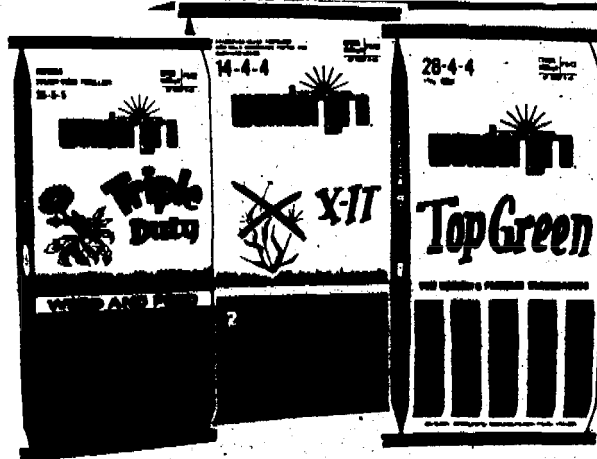

1-Bag Wondergro X-It (5,000 sq. ft.) March or April	17 <sup>95</sup>
1-Bag Wondergro Triple Duty (10,000 sq. ft.) May & Oct. 1/2 PRICE	10 <sup>48</sup>
1-Bag Wondergro Green (5,000 sq. ft.) June	8 <sup>95</sup>
1-Bag Wondergro Green (5,000 sq. ft.) August. 1/2 PRICE	4 <sup>48</sup>
REGULAR PRICE 56.80	SPRING SALE PRICE <b>41<sup>86</sup></b>
	SAVE <b>14<sup>94</sup></b>

ADDS UP TO LESS THAN 1¢ PER SQ. FT.!

Based on 1/2 off second bag sale. 1/2 off second bag will apply to lesser costing bag if mixing products.

Everything for the garden but the rain

If you buy your entire lawn care program now — you not only save money but you assure yourself of a beautiful lawn all season long.

# SAXTONS GARDEN center inc.

**587 W ANN ARBOR TRAIL PLYMOUTH • 453-6250**

DAILY 9 TO 6  
FRI. 9 TO 8  
SAT. 9 TO 5  
SUN. 10 TO 2

# Attorney doubts shoddy-building law

PG. 3  
THE COMMUNITY CRIER: April 25, 1979

A proposed Canton ordinance that would force home builders to provide strict warranties on their workmanship was put under a legal cloud by township attorney Bert Burgoyne last week.

Burgoyne said that a clause of the proposed law that would excuse the home buyer from mortgage payments if repairs weren't made would be ruled invalid by the courts.

The law was introduced to the state

legislature by Sen. William Faust last year, and Canton officials had asked Burgoyne to see if it could be adopted on the local level.

The ordinance would be in conflict with present state statutes which govern foreclosure of mortgages, said Burgoyne.

Furthermore, Burgoyne said that charter townships lack authority to enact such laws. Townships' power "extends only to matters of local concern," he

said in a letter to the board.

Faust's bill is similar to the HOW ordinance already adopted by Canton. It would give home buyers warranties things like cracked walls, leaking basements, loose stairways and loose exterior aluminum siding. However, Faust's bill would make the warranties mandatory and without a charge, unlike Canton's HOW law.

Other provisions of Faust's bill include

a two-year warranty on all plumbing, electrical, heating and cooling systems. And a 10-year warranty on major structural defects like cracked basement walls.

"I still think the township should proceed with some law," said Gary Roberts, a defeated trustee candidate in the last election who asked the board to consider Faust's bill. "These (home) problems are going to continue."

## Principals to switch schools

Two elementary school principals in the Plymouth-Canton Community Schools will trade places next year. William Lutz, principal of Smith School, and Ronald South, principal of Eriksson School will exchange assignments as of July 1, 1979. Both principals requested this transfer.

Both principals are looking for new challenges for professional growth, said Superintendent Mike Hoben. The Board of Education set this kind of transfer as one of their goals for 1978-79.

Smith Elementary School, in the City of Plymouth, is 29 years old. It has a nine-month school calendar and 500 students. Eriksson, in Canton Township, is among the newest schools in the district. It accommodates 923 students on an Extended School Year calendar.

South opened Eriksson as a new school three years ago. Staff development, setting up programs for parents, and implementing grade-level curriculum goals are among his accomplishments there. He also piloted a new report card form.

On Tuesday, May 15, from 6 to 7:30 p.m. Smith School parents can meet their new principal at the Parents-Faculty Organization student art show and ice cream social.

On Wednesday, May 23, at 7:30 p.m. Eriksson Elementary School parents will meet Lutz, their new principal, at a special open house.

Lutz has been principal of Smith Elementary School for eight years. Under his leadership textbooks have been updated and grade level curriculum goals implemented. Improvements in the building included carpeting, enlarging the media center, and developing a nature study area. Parents have enjoyed the "Bring-A-Parent-to-Lunch" plan, while students had weekly lunches with their principal, too.

## Pilot light ignites gasoline; boy jumps from 2nd story

Furnace pilot lights and gasoline don't mix.

They did Saturday afternoon, though, and the result was a basement fire at 43607 Lancaster in Canton which caused about \$10,000 damage according to Fire Chief Mel Paulun.

The home's owner, Geza Tihanyi, was cleaning out his basement with gasoline, said Paulun, when a furnace pilot light ignited the gas fumes.

No one was badly hurt by the smoky fire, which was confined to the basement, but 11-year-old David Milz jumped from a second floor bedroom window and was taken to Annapolis Hospital in Wayne with a possible fractured ankle, said Paulun.

"He used good judgement," said the fire chief. "Rather than risking the heavy smoke downstairs, it was best that he jumped."

The fire started around 5:15 p.m. in the Windsor Park subdivision home.



SCADS OF BOOKS. The American Association of University Women is sponsoring a book sale on May 3, 4, and 5 at the East Court of the Westland Shopping Center. Getting the booksale organized, above, are (from left to right): Camille Zornow, chairperson; Audrey Crain, and Lois Oldfield. (Crier photo by Bill Bresler)

## AAUW readies huge used-book sale

More than 15,000 books, magazines, and records will be on sale May 3, 4, and 5 when the Plymouth Branch of the American Association of University Women holds its 25th annual Used-Book

Sale. The sale will be at the Westland Shopping Center.

More than 50 categories are represented, including classics, children's books, cookbooks, history, science, and others. They include a set of "Life In . . ."

books which describe life in the United States and other countries; a 20 volume set "Encyclopedia of Aberrant Behavior - Crime and Punishment," a large book on Chiang Kai-Shek; and, a selection of cookbooks, including many international cookbooks.

The Old and Rare department includes first editions of "Heidi" and "The Bobbsey Twins In Washington"; a leather bound selection of "Pilgrim's Progress"; a leather-covered edition of "Typhoon" by Joseph Conrad; and some very old and interesting books.

The book sale hours are 9 a.m. - 9 p.m. Thursday and Friday, and 9 a.m. - 6 p.m. on Saturday. Camille Zornow is the booksale chairperson this year, and Audrey Crain is the assistant chairperson.

## Millage committee to meet

With a millage question on the June 11 school ballot a near certainty, the Citizens Election Committee of the Plymouth-Canton Community Schools has set an organizational meeting for Wednesday, April 25, at 7:30 p.m. at Pioneer Middle School library.

Deanna Huff was named chairperson of the Citizens Election Committee at a meeting on April 10, attended by about 25 citizens. Huff is the parent of

a pre-schooler at Canton Corners, a son at Smith Elementary School, and a daughter at Salem High School.

"We hope to involve as many people as possible in this campaign and inform every voter about the need for additional operating millage to maintain our present educational program," said Huff. "Our first project is to be sure that new residents and new 18-year-old voters are registered before the May 14 deadline."



Did you know that the Willow Tree is open evenings—Thursday & Friday



# Real Estate



BY  
**WILLIAM DECKER**  
REALTOR

## SINGLE HOMEOWNERS GROWING

Last year 15% of all FHA-insured mortgages on existing homes were made to single persons. And the rate of single homeowners is growing annually.

If you're a renting single and this thought has occurred to you, you have some hard thinking to do before you decide to make the plunge.

Not everybody is suited for the responsibilities of ownership. It's a serious commitment. You'll find yourself worrying about things like local tax rates, real estate values, trash collection schedules, and a variety of maintenance chores.

On the plus side, it's a rare homeowner who doesn't feel a tingle of pride in ownership, and who doesn't gain satisfaction from watching his or her equity grow month by month. And at income tax time, there's that nice glow you feel as you chop the cost of mortgage interest and property taxes off the top of your taxable income . . . not to mention the overwhelming opportunity for a decent profit when it comes time to sell.

If there is anything we can do to help you in the field of real estate, please phone or drop in at REALTY WORLD, Wm. Decker, Inc. Realtors, 670 S. Main St. Plymouth. Phone: 455-8400. We're here to help!

# Canton mulls tree planting

A plan to plant trees on all major road and subdivisions in Canton was presented to the Board of Trustees last night.

Written by an ad hoc committee charged with developing a tree beautification program, the plan calls for establishing a tree fund account in the general fund.

The committee also recommended that the board approve funds for a pilot program to cover all fully developed

stretches of Sheldon Road, between Joy and Ford roads, "estimated to be 110 trees at approximately \$50 each totaling \$5,500."

The long-range township policy on planting trees, said the committee, should include these highpoints:

- 1) a schedule for future tree planting.
- 2) tree planting on all major thoroughfares where the utilities and curbs and gutters have all been installed.
- 3) tree planting on subdivision lots already developed.

4) tree planting where developer has been released by the Wayne County Road Commission, where lots are fully developed and serviced by sewer and water.

Jim Kosteva, township planning director, said that planting of the trees on Sheldon may take place during the week of May 7 through 12.

Members of the committee include Clerk John Flodin, Trustee Lynne Goldsmith, Ordinance Director Bruce Phillips, Kosteva, and Citizen Martin La Forte.



AT A SPECIAL kick-off dinner of the Plymouth Landing Restaurant Friday evening, Samuel Panzica, third from left, the restaurant's owner, donated \$5,000 to the Plymouth Historical Society. Accepting the funds on behalf of the society are, from left, Win Schrader, Clarence Moore, and Margaret Dunning. Guests paid \$50 for the dinner, and all the proceeds were donated by Panzica to support the society and the Ply-

mouth Historical Museum. In gratitude the society presented Panzica a plaque, which he is holding above, which reads: "The Plymouth Historical Society extends its grateful appreciation to Samuel Panzica of Plymouth Landing for his generous contributions on April 20, 1979, to the Plymouth Historical Museum." (Crier photo by Chas Child)

## Schools want doctors' excuses

# 'Yellow flu' drivers docked days pay

Bus drivers in the Plymouth-Canton school district were docked one day of pay for "failure to report to work on Friday, March 30," according to school officials.

More than 80 per cent of the bus drivers called in sick that Friday. The action followed the two-day suspension of a bus driver for disciplinary reasons.

Meanwhile school officials asked bus drivers to submit an

excuse from a doctor before April 27 to prove they were sick on March 30. "Full consideration and investigation of such documentation will be taken," said school officials.

Following these actions, bus drivers filed a grievance with Robert Houghton, transportation director, and Walt Bartnick, administrative assistant for labor relations.

# Schools split Canton High room

Room 128 of Canton High School will be divided into two rooms this summer. The Plymouth-Canton Board of Education approved the purchase of a movable wall with six chalk boards priced at \$5,340 on Monday night.

This purchase will help ease the overload of students at the Centennial Educational Park. Some school officials

estimate the student overloads at the high schools will be at more than 200 students by next fall.

## Trick to Treats

The Old Village Sweets & Treats shop at 615 N. Mill in Plymouth was robbed of \$35.90 Thursday or Friday, police report.

The wall measures 32 feet by nine feet and is non-motorized. The money for the purchase of the wall will be taken from the 1979-80 budget since it will be installed and paid for after July 1, 1979.

The purchase was approved by a vote of 5-0 with board members Joe Gray and Steve Harper absent.

# Tell us: Why is your Mother super

If you are between the ages of eight and 10, you can nominate your mother for Plymouth's Super Mom contest.

Sponsored by the Plymouth Jaycettes, the contest is open to all children who live in the City of Plymouth or Plymouth Township.

To enter, you must write an essay entitled, "Why my Mother is Plymouth's Super Mom," and it must be written or printed in the child's own handwriting on one side of an 8½ x 11 sheet of paper.

The child should add to the essay his name, address, school, and age. The entry must be postmarked no later than April 30 and sent to Super Mom, Mrs. J. Withers, 40970 Ann Arbor Tr.,

Plymouth, Michigan, 48170.

The winners will be announced the week of Mother's Day, and will receive a grand prize of dinner for three at the Hillside Inn. Other prizes will include

brunch at the Mayflower Hotel, and brunch at the Hilton Inn.

For more information, call Maureen Karby at 459-9893, or J. Withers at 455-6613.

the Community  
**Crier**

Published each Wed. at 1226 S. Main St., Plymouth, Mich. 48170  
Carrier Delivered: \$8 per year. Mail Delivered: \$13 per year. Mailed at Controlled Circulation rates, Plymouth, Mich. 48170

## PLYMOUTH JAYCETTES SUPER MOM CONTEST

Name .....  
Address .....  
School .....  
Age .....

(Mail with essay to "Super Mom", Mrs. J. Withers, 40970 Ann Arbor Trail, Plymouth, Mi. 48170)



# WE'VE LANDED!

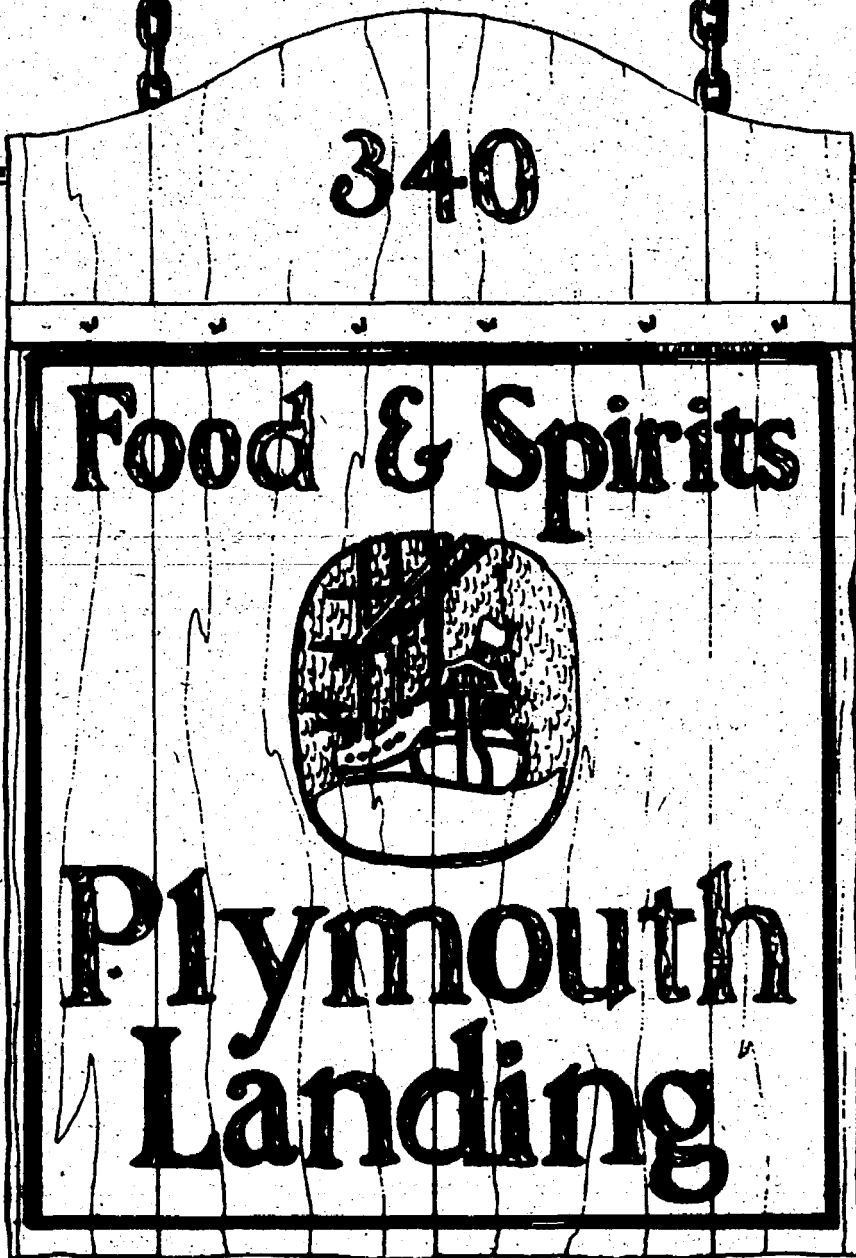
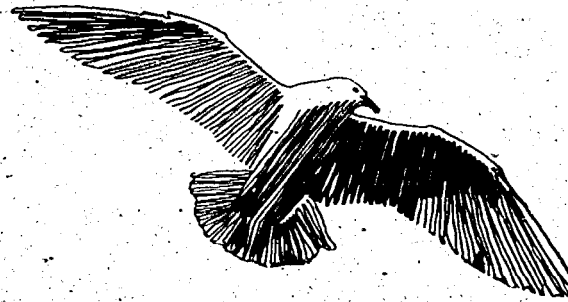
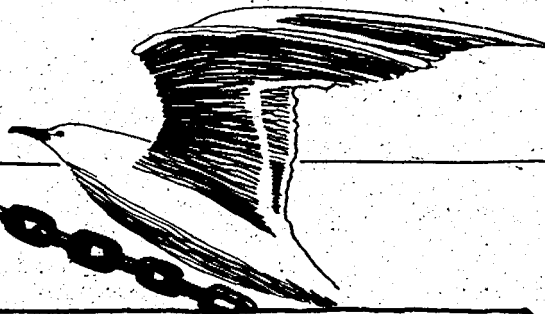
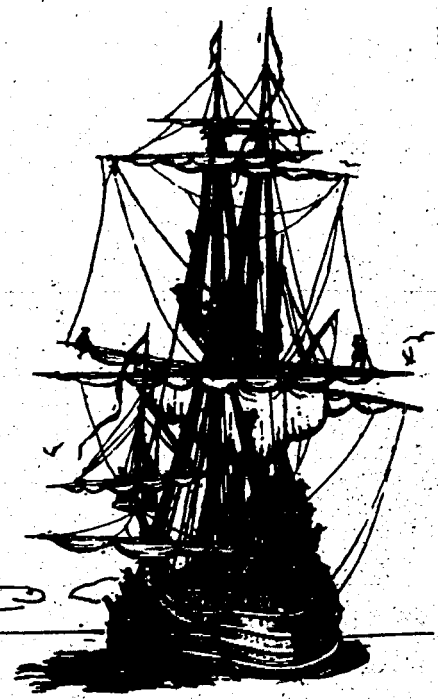

We're open and ready to serve you the finest food in Plymouth.

Featuring the best in fresh caught seafood and extensive luncheon and dinner menus (not to mention Sam's specialty veal dishes from Verona, Italy!)

All served up in a traditional atmosphere of beautiful stained glass and the building's original wood beams.

Our kitchen is open from 11-11 daily, but we keep the lounge open later on weekends. Stop by and see us soon!

Your host: Sam Panzica

for reservations  
Call

**455-3700**

WE HONOR ALL  
MAJOR CREDIT CARDS

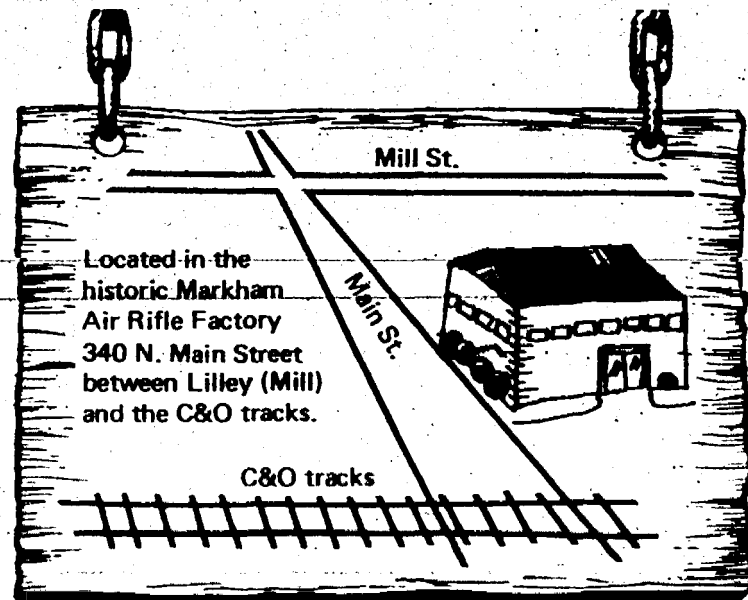

WEDNESDAY  
MAY 16 1979  
ALICE  
TOWNSHIP  
NONE

W. EDWARD WENDOVER



## Don't let sheriff patrols kid you

Mixing politics with police can be dangerous.

But it's inevitable when communities like Plymouth and Canton townships grow to the point that providing police protection becomes an absolute necessity.

Canton, fortunately, has risen above the political games that plague its other governmental functions. Its police department now provides satisfactory service to township residents while ignoring the political shenanigans that marked the department's founding. The credit there goes to Chief Walter MacGregor, a street-wise veteran who'd rather go fishing up north than play hatchetman for the politicians.

Can Plymouth Township be so lucky?

For the wrong reasons, the township is now considering adding police protection to its growing list of services.

Why should Plymouth Township provide police protection?

Because it's needed.

But why are township officials considering it?

Because it will help fight off annexation. (A new law protects charter townships from annexation if they offer garbage collection and police protection.) The township board voted to switch to charter status and, if petitions seeking a referendum on that issue are not filed by May 29, Plymouth Township will automatically become a charter township.

So how will Plymouth Township provide police protection?

First of all, it must raise money. That means a vote of the people and such a millage request is now scheduled to be put before voters in Sept.

If Plymouth Township voters — who have turned down police millages in the past — approve the measure, where do the police come from?

The answer to that should be simple.

Have you noticed all the Wayne County Sheriff patrol cars around the township lately?

The county sheriff, according to the Michigan constitution, provides police protection in the unincorporated areas. But in Wayne County, that's been a joke.

Faced with budget problems caused by the Wayne County Board of Commissioners Pork Barrel approach to business, services (including the sheriff patrols) have always been cut in the out-county area.

Now, all of a sudden, the sheriff patrols are thick in Plymouth Township. Is it because crime is up and the sheriff has finally seen his responsibility in providing police protection?

No — it's because Plymouth Township is considering hiring the sheriff to provide adequate law enforcement. Look at what the thick-as-flies patrols are doing. They're writing a lot of traffic tickets, which provide high visibility, but little else.

On one recent occasion, a call to the Wayne County Sheriff about vandalism in progress brought the response, "We have no available units in that area." Yet a sheriff patrol car was busy writing traffic tickets less than a mile away in the township.

If the Plymouth Township board members are fooled into thinking that this level of sheriff protection is what the township will get once the contract is signed, they'd better think again.

In fact, if the township board members were smart, they'd strip Wayne

County along for a few years and enjoy the current campaign level of sheriff patrols.

Where, in all this, is the City of Plymouth? In the past the city has made proposals to provide police protection to the township and expressed an interest in doing so again this time.

But after Plymouth Police Chief Timothy C. Ford discovered the city would have to charge \$480,600 for the first year of a two-car patrol with back-up services, the city commission decided not to bid this time.

Mayor Tom Turner, who originally refused to reveal the city's cost estimates and Ford's report, said simply that the city couldn't match the county's bid of \$227,000 to the township. He attacked the county's apparent subsidy of providing the same amount of police protection to Plymouth Township.

If that's the case, why did he want to hide Ford's analysis of providing police protection? (The figures here were obtained by The Community Crier which filed under the state's Freedom of Information Act to get Ford's report.) If Turner really felt incensed, why not use Ford's report as a comparison and raise hell?

Maybe it's because the city can't clear its conscience and really strive to help Plymouth Township provide police protection that will help block annexation.

One hole card not yet played is the possibility that Northville Township could bid to provide Plymouth Township police. For that matter, so could Livonia or even Canton, but they haven't been contacted.

Contracting with any of those local departments would yield better control of police activities in the township. The octopus of county government passes the buck of responsibility at the sheriff department and Plymouth Township officials would find it difficult, if not impossible to get accountability with Wayne County Sheriff protection.

And so, between now and the September election (assuming the township board wouldn't sign a county contract before millage approval), politics and police go together like a horse and carriage in Plymouth Township.

Let's hope the township board doesn't put the cart before the horse and remembers which end of the horse is the front.

Police protection is needed in the township, but anything less than top quality is a sham and a waste of taxpayers' money.

## Y has done a lot for me, look closely at its good

EDITOR:

Early this month a copy of a local paper was delivered to me along with my hot lunch from Tonquish Creek Manor. Being a partially blind senior citizen and unable to read well my neighbor read me the article about the alleged misuse of funding of the Senior Citizen Program of the Plymouth/Canton YMCA.

Now, I would like to tell you just what the YMCA program has done for me. In addition to my visual problem, I have severe arthritis in my hands, feet and hips.

I have had surgery on my feet and am still unable to get around very well. I also need a hip replacement. I only mention these to show you how much help I need to manage my own life.

When the YMCA Senior Citizen program began my rheumatology specialist from Wayne County General Hospital recommended that I call the Y for assistance. In the beginning a driver from the Y picked up and delivered a hot lunch to me 5 days a week from Tonquish Creek Manor.

Then the Y began to provide transportation and errand running for me. They would take me grocery shopping if I was unable to do the shopping. They picked up my medications from the drug store, they took me to the bank to cash my checks, to the post office for stamps. On election day they even took me to the polls.

The Y even got involved by interceding on my behalf to the Lions Club which provided me with an illuminated magnifying glass to help me read.

At that time, I was living in an apartment in an old house which had frequent and prolonged furnace trouble in the dead of winter. The Y knew about this and provided me with an electric heater to use until heat was restored.

I feel this saved my life as the furnace was out for many days and the temperatures were sub-zero. Mrs. Compo from the Y felt I should not have to continue living under such adverse conditions and proceeded to get me on a list for subsidized housing which I never knew existed.

I was awarded a subsidy and now, thanks to the Y, live in a new heated apartment.

When it was time for me to move I had no funds and no one to help me with the move. The YMCA again helped me by providing their van and two lovely people to help me make the move at no cost.

My friendly Y helpers even hung my curtains, lined my shelves, put my clothing away and arranged my furniture. What would I do without them?

Perhaps the people who are criticizing this program should look more closely at all the good they do.

This letter was dictated by me but written by a neighbor.

AMELIA NEUKIRCH

## community opinions

### Canton shouldn't renege on liquor license OK

After ordering a dish at a restaurant, a customer certainly can ask the waiter to take it away if it's not to his liking.

But this principle shouldn't hold true in the less than savory world of politics. Canton's Board of Trustees granted the Canton House Restaurant an OK for a liquor license in November and now it is considering taking it away.

That would be unfair. Although the Canton House may not be everybody's favorite restaurant, it's customers have

as much right to drink as any other restaurant's.

Furthermore, the owners have made plans to expand and have spent a good deal of time applying for the license which is waiting approval by the state Liquor Control Commission.

But deeper than this is a hope that Canton elected representatives, the holders of the public trust, can be taken at their word. Unless there's been some breach of faith, the board should not capriciously yank recommendations for liquor licenses, or fire employes or withdraw contracts.

Be straight with the Canton Houses' owners, trustees. Don't kill their liquor license.

THE COMMUNITY CRIER

### Good Friday is holiday

EDITOR:

The bus drivers do not "claim" that Good Friday is one of their paid holidays. It is fact, and has been a paid holiday since the first contract was drawn up and approved in 1969.

Our 10 paid holidays are the same ones nearly any other working group gets. I would hazard a guess that they also get a paid vacation when they work 12 months — we don't.

CHRIS BELLANGER

No. 71



## Community The Crier

THE NEWSPAPER WITH ITS HEART IN THE PLYMOUTH-CANTON COMMUNITY

1226 S. Main St. Plymouth, Michigan 48170 (313) 453-6900

W. Edward Wendover, Publisher; Chas Child, Editor; Bill Bresler, Photo Editor; Patricia Bartold, Feature Editor; Fred DeLano, Columnist; Mike Carne, Production Manager; Phyllis Redfern, Circulation and Office Director; Melanie Robinson, Business Manager; E. Dale Lee, Sports Editor; Patty Radzik, Asst. Sports Editor; Fran Hennings, Pat Steele, Judy Stewart, Robert S. Cameron, Advertising Consultants; Cynthia Trevino, Artist; Karen Sanchez, Typesetter; Judy Bode, Circulation Asst.



Recycle Your Newspapers

PUBLISHED EACH WEDNESDAY by Plymouth-Canton Community Crier, Inc.

Carrier Delivered: 70 cents monthly; \$8 yearly.

Mail Delivered: \$13 yearly in U.S.A.



Member

## Are Canton cops full time?

Do Canton residents really have the full time police protection they fought so hard to attain? When calling the police department last Saturday to complain about illegally parked cars, I was told that there wasn't much they could do about it. If they can't enforce the law, who can?

Because of narrow streets in many subdivisions, one side of the through streets are posted with signs reading "No Parking Fire Route." These signs were installed for a reason - to make sure the fire department with its large equipment could get through the streets in case of an emergency.

The officer on duty last Saturday afternoon told me that because of a subdivision garage sale, with 911 families participating, there was too large a crowd to do much about the traffic and illegal parking situation. Although many residents were involved in the garage sale, most of the 911 families did not participate.

About an hour and a half after my

## Hold hog auctions in Kellogg Park

Where I often have a noontime snack in Plymouth, the conversation isn't always of sports, feminine charms, or politics.

As a diversion, for instance, two of us frequently discuss Kellogg Park's potential as site of an annual hog auction, particularly if we could arrange with the tourist bureau for a wind out of the east.

It might produce the biggest hulla-baloo since the year the Fall Festival committee had the gall to plan placement of its booths over the newly laid Kellogg Park walkway facing Main Street.

You see, many of those bricks are inscribed with names of persons who donated to the park beautification program. It was considered a civic sin to hide the names from view during the festival, and that's when it was agreed to relocate the booths in the street.

By this time, you get the gist. Our luncheon gatherings attract nothing but extremely deep thinkers.

This week, there's invariably a reminder from one or another of the troops that we all should remember to turn our clocks ahead one hour when we hit the sack Saturday night.

If you weren't aware, it was by U.S. Congressional action in 1966 that the period running from the last Sunday in April until the last Sunday in October was designated for uniform daylight saving time.

Michigan has gone through some pretty good fights over the daylight saving time issue, part of the problem being that we are neither all fish nor all fowl.

If you had grown up with me in the southwest corner of the state, you would remember keeping your timepieces attuned with Chicago even though the Detroit area moved up 60 minutes in the summer to be abreast of New York. Through the years, there have been numerous instances of similar confusion.

As the time matter continued to gnaw, it drove me to research. Knowing that this enlightened readership has an insatiable desire for ever increasing its fund of knowledge, I am willing to share my findings.

Think of the social sensation you will be when you break one of those awkward silences at some dull party with a gem such as this: "Isn't it interesting that 100 years ago, Michigan had 27 local times in different communities across the state, Wisconsin 38, Illinois 27 and Indiana 23?"

Or, frame a conversational coup from these facts:

call, there was an emergency, sending four fire trucks and a rescue vehicle roaring down the street. Fortunately it had started to rain in the meantime, sending most of the bargain shoppers home. What would have happened if that emergency had happened earlier in the day, when the emergency vehicles couldn't get through? How would the officer on duty explain to the people whose house was on fire that there wasn't much they could do about it?

A subdivision garage sale is a great idea, and I can live with the idea of traffic on the street for a weekend, providing the bargain seekers obey the law. There's no excuse for people parking in the fire lane, in front of a fire hydrant, or blocking a drive way. And, there's no excuse for the Canton Police Department not enforcing the law.

Taxpayers in Canton deserve what they're paying for - a full time police department that can do something about it.

PHYLLIS REDFERN



**bifocals**

by  
**Fred DeLano**



For centuries, the basic clues of nature - sunrise, high noon and sunset - were used to tell time.

In fact, it wasn't until 1883 that most countries of the world, including ours, joined hands to divide the world into 24 time zones, which remain unchanged. Each zone spanned 15 degrees of longitude and everyone reset his watch. It was about time.

In the United States, the big push came from the railroads. Before that, trains ran on the local time of the biggest city on the track. Across the country, railroads used some 100 such local times.

The idea of splitting our continent (U.S. and Canada) into Atlantic, Eastern, Central, Mountain, Pacific, Yukon, Alaska and Bering time zones came from a man named Charles F. Dowd.

At the time, he was principal of a ladies' seminary in Saratoga Springs, N.Y., and maybe that will prove to you how far afield the mind can be driven from too much association with the fair sex. Anyway, the whole changeover came on Nov. 18, 1883.

When World War I came along, some genius talked Great Britain into adopting daylight saving time as an economy measure. The United States followed in 1918, but even though Congress repealed the law in 1919 the concept was here to stay.

Some cities, states and just parts of states continued the practice, and the whole country went that route during World War II.

Some places even advanced clocks two hours during the summers of that spat, and the term "war time" was coined.

The cows didn't like it, and they won't like next week's 60-minute adjustment either. But the extra daylight certainly will help the hog auction.

Don't pick up  
the same old chicken tonight  
Try Famous Recipe

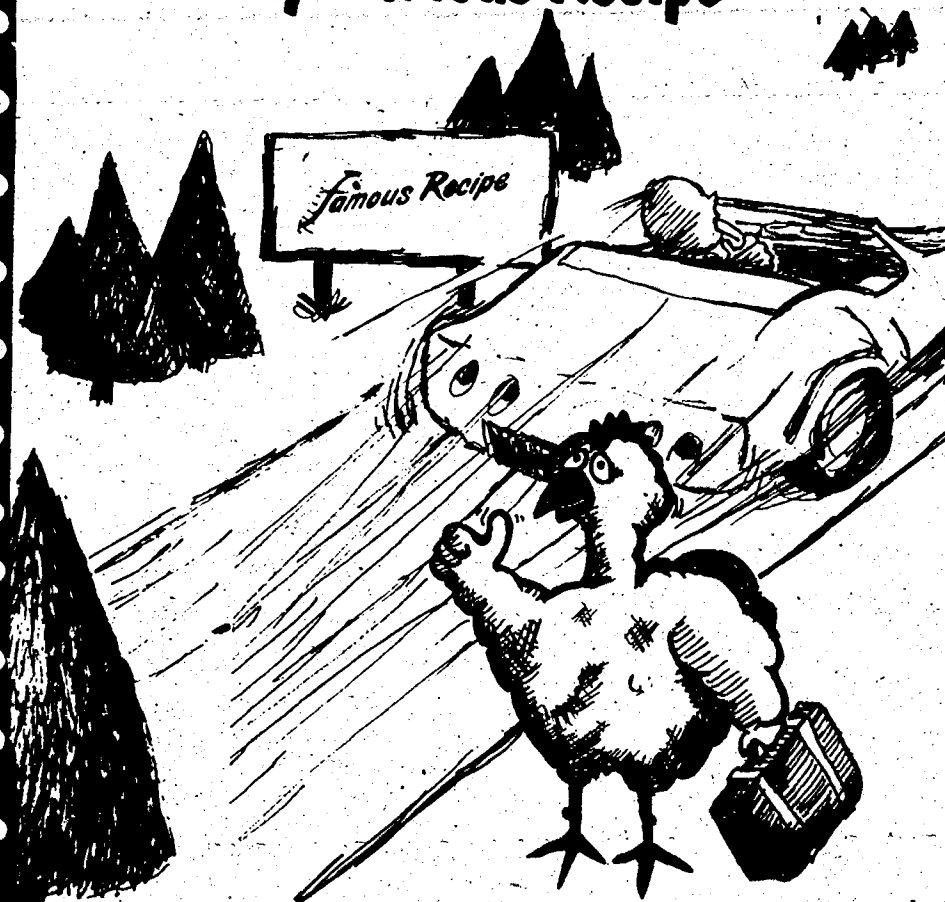

We Specialize in:

**Chicken**

Fish (specially great now!)

Shrimp (specially great now!)

Homemade Salad

Livers-Gizzards

Roast Beef

Potatoes & Gravy

Hot Baked Biscuits

Chili

Chicken & Noodles

Barbecued Chicken

Chewy Chocolate Chip Cookies

Assorted Desserts

Thank goodness for the goodness of

**Famous Recipe**

**FRIED CHICKEN**

**Grandma's Take Home**

1122 W. ANN ARBOR RD. Proprietor, Joe Langkable

**Call 453-6767**

**HOURS**  
10:30 to 9PM



Let's Talk  
Real Estate



by Barbara M. Olson

Although prices in many areas seem very inflated, reasonable buys still exist in the suburbs and certainly in rural areas. With more than 70 percent of our still expanding population continuing to congregate in the nation's major metropolitan areas, the likelihood is for sustained price advances in the years ahead. Consult your real estate broker for going prices on various types of land in this category; on zoning matters affecting property in desired locations; on current population and growth trends; plans for new or expanded public services, schools, hospitals, bus lines, and recreational facilities.

Buying a home is a very reasonable way to protect yourself against the ever-increasing effects of inflation! Visit the office of REALTY WORLD-COLONIAL VILLAGE, INC., 42142 Ford Rd, Canton, 455-7790 and let our professional staff show you how to make a home of your own affordable now. Stop in and check our selected listings of choice sites in all price ranges. "The All Service Real Estate Office" Open: Mon-Sat 9-9; Sun 10-6.

# Deficit

## Schools pare down down red ink

Plymouth-Canton school officials have pared down the fund balance from \$1,491,136 on June 30, 1978 to a projected fund balance of \$516,136 on June 30, 1979. That means the projected current year deficit is about \$975,000.

These budget figures were released to the Plymouth-Canton Board of Education on Monday night by Ray Hoedel, assistant superintendent of business.

Other figures showed that the cafeteria fund shows a net loss of \$29,524 so far this year. Hoedel said this figure may

shrink as cafeterias use surplus foods towards the end of the year.

Under transportation, a deficit of \$50,000 was exposed. According to Hoedel, driver salaries and higher than anticipated operating expenses were the main causes.

On the other side of the coin, the school district earned about \$62,000 in interest returns on investments.

This status report on the budget will be updated over the next months as the fiscal year ending on June 30 approaches.

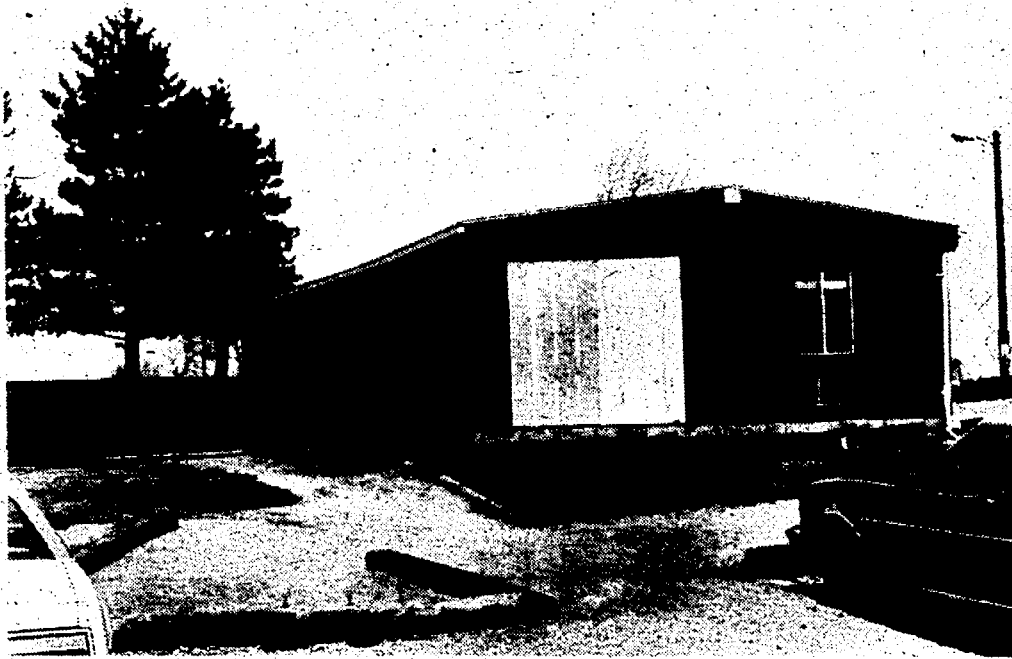

**THE PLYMOUTH** Township meeting room was moved to the Hilltop Golf Course on Saturday morning where it will be used as a clubhouse. The three-mile trek across the township took about 20 minutes and, because of the lightweight construction of the room, no difficulties were reported, said Supervisor Tom Notebaert. (Crier photo by Bill Bresler)



Denise Woodward

"I want to be your decorator"

**TOP TREATMENTS 40% off!**  
WITH COORDINATING DRAPERIES

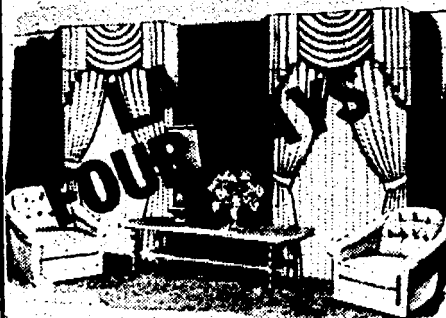

ALL STYLES

- \*Top Treatments
- \*Austrian Valances
- \*Swags
- \*Soft Cornices
- \*Jabots
- \*Pleated Valances

Valances give custom draperies the decorator look. Decorating Den valances are handcrafted by skilled seamstresses with years of experience. Prices begin at \$36.25 (Regular \$60.42) for up to 59" wide by 17" long. Call Decorating Den today.

Never any charge or obligation

**459-2020**

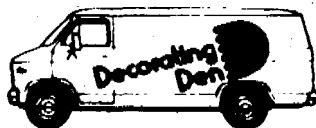

the important decisions should be made at home.

## Twp. may buy land to double links

BY FRED DeLANO

Plymouth Township residents may be able to circle the date of Tuesday, April 24 as the point when their government turned the Hilltop Golf Course area into the hub of one of the finest recreation areas in southeastern Michigan.

Tuesday night, the Township Board of Trustees was expected to give its go-ahead to purchase an additional 33.26 acres of the old Amrhein homestead for \$282,710, using this in the next year or two to expand the township's Hilltop Golf Course from nine to 18 holes. This is considered the only true configuration of a championship golf course.

Whether the Amrhein heirs would accept the offer, or ask to go back to the bargaining table, wasn't clear. What the board had to go on was this assurance from Supervisor Thomas Notebaert after a recent conference with Arthur Amrhein, executor of the family estate:

"As he had indicated to me in our previous meeting, he contacted his nieces and nephews regarding sale of the property. It was their feeling that they consider the property to be worth \$9,500 per acre. "This assumption is based upon the many inquiries by developers. He agreed that all the offers were based on various conditions.

"After a lengthy discussion, he agreed to try and encourage the other members of the family to accept \$8,500 per acre. There are 33.26 net acres for a total price of \$282,710. He felt terms could be extended over five years with interest at the current rate."

Approval to negotiate for acquisition of that land to provide expansion of the golf course already has been given at the polls.

Although the figures at which the

original Amrhein land first was offered and then finally purchased by the township now are only academic, they show the inflationary trend of the 1970s. What now is Township Park was first available at \$2,200 per acre, but ultimately commanded \$2,600 after a second election.

The park itself is undergoing a topographical facelifting this spring highlighted by the construction of an open air pavilion to complement softball diamonds and picnic areas.

There still is a vacant gap of from 12 to 15 acres on the north side of this entire complex which the township is eyeing for potential recreational expansion. It also serves as a buffer between the park and Glenview Subdivision. However, the owner is the Plymouth-Canton Board of Education which regards it as a natural site for another elementary school.

In still another related matter, the township trustees were scheduled to go back Tuesday night to their budget drawing board and at Notebaert's request considered adoption of an item apart from the general fund identified as the

"Golf Course Fund."

It is to be financed in 1979-80 by the \$28,000 guaranteed by Hilltop operator John Jawor.

Recreation Committee Chairman Frank Millington reminded trustees that under the contract with Jawor "the township is responsible for all physical improvements to the course."

In specifying immediate expenditures of about \$16,000, Millington said the "thrust will be towards visual appearance, security, encouraging play, improving fairways, greens and tees, and providing residents with a facility which will reflect the true image of the township."

Millington's committee has in mind additional fencing on Hilltop's Powell and Beck Road sides, construction of a practice putting green, planting of numerous new trees and possible restructuring of the sixth hole to turn it from a Par 3 to 4.

A number of lesser improvements, such as installation of ballwashers at the tees and directional markers where needed, also are contemplated.

Prior to the Tuesday night board meeting, both Notebaert and Trustee Maurice Breen (an ex-supervisor himself) indicated after reading agenda memoranda that they would support all golf course and recreation park items being brought before them.

Giving Hilltop golfers another shot of interest this week was the fact that the portable structure which for several years had been used as a courtroom adjunct to Township Hall finally was moved to the course to serve as a new clubhouse, replacing the facility destroyed by fire last fall.

However, it will be mid-May before plumbing, electrical and interior necessities make it usable by the "Fore" set.

### Ticketees off hook

If you have a City of Plymouth parking ticket that's two years old or older and hasn't yet been paid -- you may well be home free.

City Attorney Charles Lowe told the City Commission last Monday night that under the city charter, there is a two-year statute of limitations on parking tickets.

Lowe said a recent defendant in a parking ticket case successfully fought the charge using the statute of limitations defense.

# Sludge concerns bother Canton board members

Cont. from pg. 1

posting piles could contaminate the environment. "It's been shown that there is PCB (an industrial toxic chemical) in the compost," he said.

Culbert added that he plans a thorough chemical analysis of compost from a pilot project conducted by Bi-Products in Sumpter Township.

To combat possible contamination, Bi-Products officials said that monitoring of the plant will be done by both the state Department of Natural Resources and the federal Environmental Protection Agency.

One resident said, however, that both these agencies are short-handed and may not be able to make as many tests as necessary.

Canton Planner Jim Kosteva said that Bi-Products is tentatively scheduled to come before the Planning Commission on May 14 to ask for site-plan approval of its project.

A decision may be delayed beyond that date, though, if planning commissioners desire more information on the project, he said.

An environmental impact statement is still due from Bi-Products, said Kosteva.

## Check your dog for worms

Protect your dog against heartworm. Local veterinarians recommend that your dog be checked for heartworm in March or April of each year. Then the dog should be given a preventative medicine daily from May 1 to December 1 to keep the animal free from heartworm. Veterinarians say the preventative medicine is fairly inexpensive.

This advice is given during spring to

dog owners to prevent the spread of heartworm. The heartworm parasite is carried by mosquitoes and transferred to the dog when it is bitten by infected mosquitoes.

Southwestern Michigan, which includes Plymouth-Canton, is one of the most densely populated areas for reported cases of heartworm in the country.

## Press and courtrooms discussed

On Wednesday, May 2, 35th District Court Judge James Garber will be featured on a panel discussion on "The Press in the Courtroom." Other participants are W. Edward Wendover, publisher of The Community Crier, and

John Thomas, a local attorney.

For more information about the times and places of each of these talks, contact Canton High School at 453-3100.

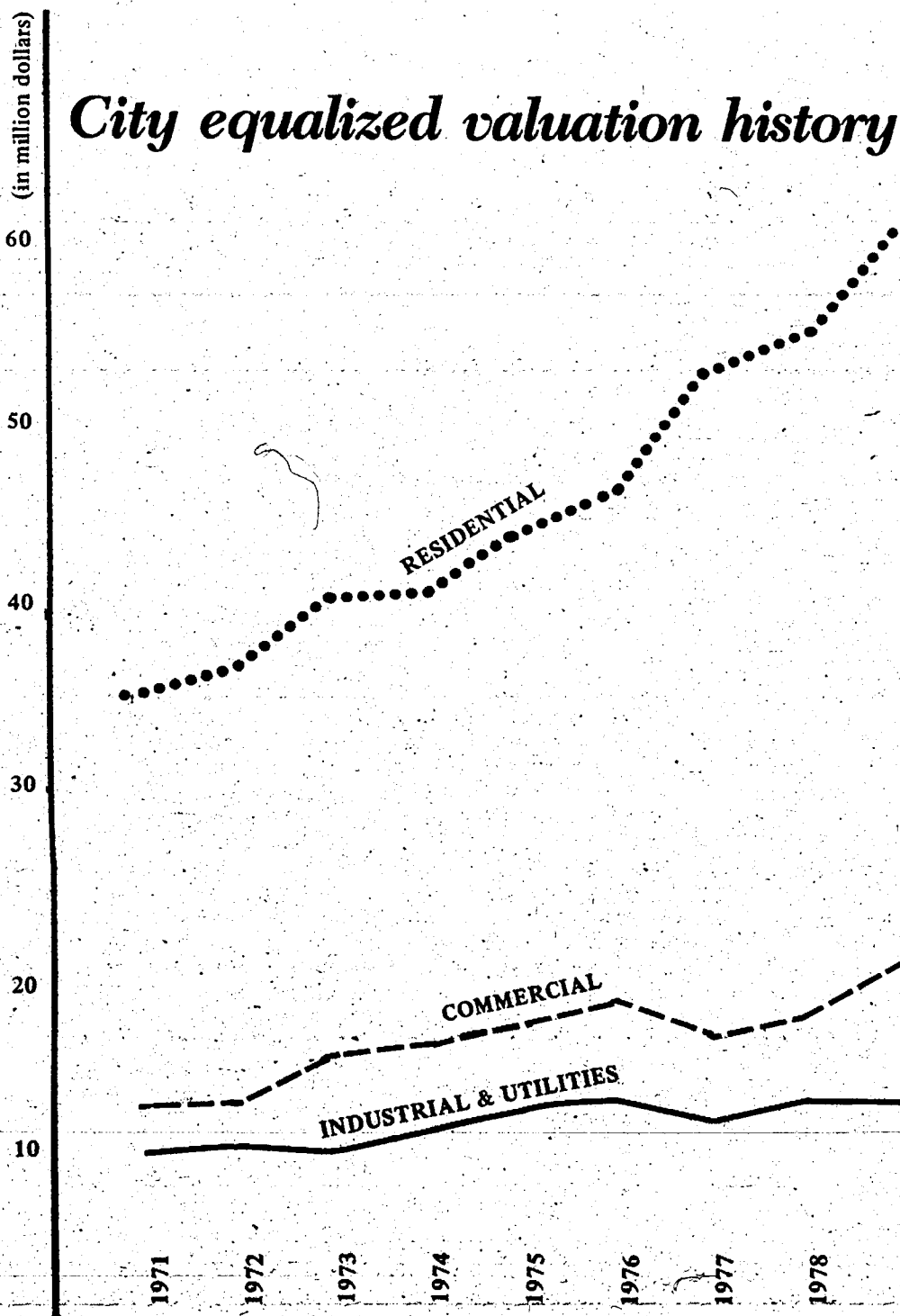

## City taxing histories show increase trend

TEN YEAR HISTORIES of the City of Plymouth total state equalized valuations by property class (above) and the millage rate (below) show the general upward trends projected for the coming year as well. The real property valuations show how the city's tax base has become increasingly residential in relation to the commercial and industrial classes. If the City Commission approves the projected 16.45 mill tax rate, it will tie the all-time city levy of 1974 to 1977. A public hearing on the proposed budget — including the half mill tax rate hike — will be held at 7:30 p.m. Monday at City Hall. The City Charter calls for adoption of the budget by the commission's May 7 meeting.

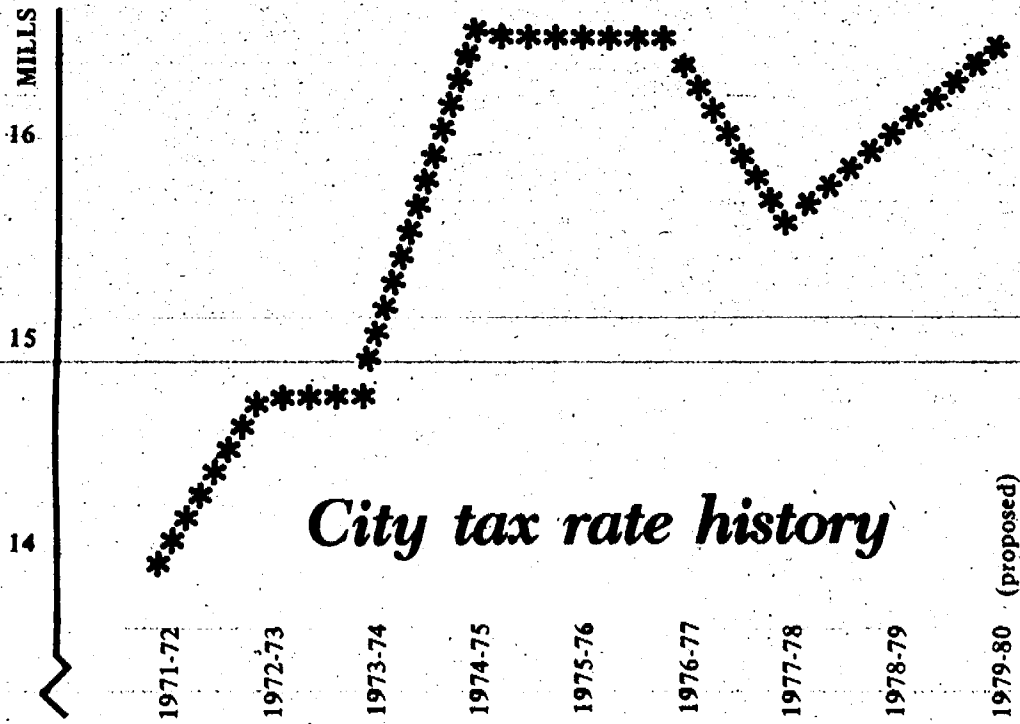

## BUSY BEE CRAFTS

**42320 Ann Arbor Rd.**

RETAIL SALES AND CLASSES

★ Register Now

**Quilting Class** Thurs. May 3rd., 7-9 p.m., \$15, 6 weeks.

**Advanced Needlepoint** Wed. May 16th., 7-9. 4 weeks, \$15 includes supplies.

**Macrame & Basketweaving** Wed. May 16th., 10-12, 7-9 p.m. Thurs. May 17th., 1-3, 7-9 p.m. Mrs. Kabel, \$12.50 five weeks

**Broomcorn Basket** Sat. May 19th., 1-3:30 p.m., \$5 includes materials

**Dip n' Drape** Monday, May 14, 7-9 p.m. Tues. May 15, 10-12 2 weeks \$8.50 includes supplies

**Quiltery** Fri. May 18 10-12 Tues. May 22 \$7.50 plus supplies 3 weeks

**Crewel** Mon. May 14th., 7-9 p.m. \$10 plus supplies 4 weeks

**Stained Glass Supplies In!**  
455-8560

OUR NEW LOCATION



DON PETERSON

# friends & neighbors

## Antique tool collectors gather on Sunday to swap stories

BY PATRICIA BARTOLD

Don Peterson of Plymouth Township is a salesman by profession, but a carpenter at heart. He collects tools and is one of two directors of the Mid-West Tool Association. About 70 members will meet at the Plymouth Historical Museum on Sunday, April 29 from 1 to 4 p.m. to display their many antique tools — which tell of days long gone. The display is open to the public.

Members will meet to examine each other's hardware, swap stories, and keep a grip on some of the obsolete ways of living represented by these tools.

For example, Peterson picked up a croze from his red-and-black checkered bag. It's a curved wooden panel which was used to carve V-shaped slits into the inner edge of a barrel. These slits enabled shippers to lock the lid on the barrel tightly.

Why were barrels used extensively for shipping during the early days of settling? Barrels were easy to roll, said Peterson. "After all, we didn't have forklifts to pick up heavy loads," he added.

Peterson examined the croze more carefully, turning it over and over in his hand. He unscrewed a series of washers which held a screw on the other side. The last washer in the set had a picture of a ship with full sails engraved on its side. Etched along the border were the

words: Credit Webster Current 1841. Peterson suggested the piece may have been a ship token that had been drilled to use as a washer.

Tools are more than simple objects to Peterson. They are an extension of a man's hand and tell what chores were important to him and why he performed them, he said.

"A tool without its setting is incomplete," he added. He said when he visits museums to see paintings or other works of art he pays special attention to the objects in the picture. "Sometimes a figure will be sitting on a barrel or he will have a tool in his hand," he said. The settings tell about the figure too, he said.

Probably the best part of Sunday's gathering of tool collectors will be the stories exchanged and the tradition that will be given new life, he said.

The old tools have come from various sources — antique stores, old basements, and as gifts from friends. "Tools are like lovers — the closer they are, the better," he laughed.

As a last note, Peterson urged ambitious spring-cleaners not to throw away weird-looking objects abandoned in dusty corners of the garage or basement. "Don't throw them away; give them away to somebody who collects them," he urged.

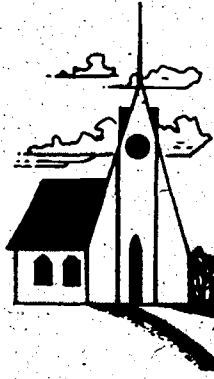

### Your Guide to Local Churches Come Worship With Us

#### The Colony Bible Fellowship

(The Wesleyan Church)

42290 Five Mile Road  
Plymouth  
420-0484 or 420-2898  
Gary A. Curell, Pastor

Sunday School 10 a.m.  
Worship Celebration 11 a.m.  
Gospel Inspirations 6:30 p.m.

#### Calvary Baptist Church

43065 Joy Road  
Canton  
453-6749 or 455-0022  
Dr. G. Douglas Routledge

Bible School & Worship  
9:45 & 11 a.m.  
Evening Evangel. 6 p.m.

#### Dixboro United Methodist

5221 Church Rd.  
Corner of Ann Arbor Rd.  
& Cherry Hill  
665-5632

Rev. Hal Ferris 662-3645

Church School 9:30;  
Worship 10:45; Coffed 11:45

#### Lutheran Church of the Risen Christ

Missouri Synod  
46250 W. Ann Arbor Rd.  
1 Mile West of Sheldon  
453-5252

Rev. Kenneth E. Zielke

Sunday Services 9:00 & 10:45  
Sunday School 9:00 a.m.

#### Central Baptist Temple

670 Church St.  
455-7711 or  
455-HELP

Dr. Stan Jenkins, Pastor

Sunday School 10 a.m.  
Sunday Services 11 a.m. & 6 p.m.  
Wed. Bible Study 7 p.m.  
Active Youth, Bus Ministry

#### The Salvation Army

290 Fairground  
Plymouth  
453-5464

Lt. Bill Harfoot

Sunday School 9:45 a.m.  
Morning Worship 11:00 a.m.  
Evening Worship 6:00 p.m.

#### People's Church

Worshipping at Plymouth  
Canton High School  
8415 Canton Center Road  
Canton, Michigan  
981-0499

Rev. Harvey Heneveld, Pastor

Morning Worship 10 a.m.  
Fellowship Hour and Sunday  
School following

#### Plymouth Church of the Nazarene

41550 E. Ann Arbor Tr.  
453-1525  
Carl R. Allen, Pastor

Sunday School 9:45 a.m.  
Sunday Services 11 a.m. & 6 p.m.  
Midweek Service (Wed.) 7 p.m.

#### Faith Community Church

Meeting in Pioneer  
Middle School  
46081 Ann Arbor Rd.  
Rev. Darryl Bell  
459-2199

Sunday School 9:15 a.m.  
Family Worship 10:30 a.m.

#### First Church of Christ Scientist

1100 W. Ann Arbor Tr.  
Church & Reading Room  
453-1676

Church & Sunday School  
10:30 - 11:30 a.m.  
Wed. Church 8-9 p.m.

Reading Room  
in Forest Place Mall  
All Are Most Welcome

#### First United Methodist Church

45201 N. Territorial  
453-5280

Samuel F. Stout  
Frank Lyman, Jr.  
F.C. Vosburg

9:30 & 11:00 Worship & Church  
School

#### Landmark Baptist Church

Fundamental Missionary  
Premillennial  
11095 Haggerty Rd.  
betw. Ann Arbor Rd.  
& Ann Arbor Tr.  
Plymouth  
453-9132

Rev. James R. Dillon

Sunday School 10 a.m.  
Evangelistic Serv. 11 a.m.  
Even. Evang. Serv. 7 p.m.  
Wed. Bible Study 7 p.m.

#### Tri City Assembly of God

2100 Hannan Rd.  
N. of Michigan Ave.  
721-6832

Rev. E.W. Raimor

Morning Worship Serv. 11 a.m.  
Ministry to the Deaf  
Sunday School 9:45 a.m.  
Evangelistic Service 7 p.m.



# tell it to Phyllis



Bridge is a unique and different kind of card game. It is a game that requires a lot of remembering, a lot of concentration, and a lot of alibis, trying to explain the reasoning behind your bid.

There are as many different kinds of people who play bridge, as there are ways of playing the game. There are people who are good bridge players and know what they're doing; there are some people who just think they know what they're doing; then there are people who can bluff their way through anything; and then there is me. I never know what I'm doing and it's quite obvious to everyone, but why let a little thing like ignorance get in the way of a good bridge game?

I'm not often asked to sub in a bridge group, and when I am it's because they are really desperate and in need of a dummy to fill in. Once a group has seen my true abilities in the art of playing the game, they seldom ask me back, but that's OK. I know who my true friends are.

I don't understand how people can take a silly card game so seriously. Why should my partner turn pale just because we went down four, doubled (so I forgot about a couple of aces that hadn't been played yet).

There's only one thing worse than playing bridge with a serious bridge player, and that's having to be partners with your husband. Four rounds of playing bridge with your husband, (at least with my husband) is almost grounds for divorce. I'm surprised that he can even hold the cards in his hand, because he sure isn't smart enough to know the difference between a club and a spade.

I play bridge once a month in a ladies card group. They let me join before they found out how well I played. Now they don't know how to get rid of me without hurting my feelings. Most of the women in the group know what they're doing, but there is one who plays almost as uniquely as I do. Last time she didn't know what to do, she dumped a coke in my lap. That's not a bad play (if you're not on the receiving end of the coke), because everyone gets so confused they don't notice what you bid.

There has got to be more in life to get serious about than a silly ole bridge game.

\*\*\*\*\*

Outstanding students in the College of Engineering at Michigan State University were given academic achievement and service awards at the college's annual awards ceremony.

Susan Kloosterman, daughter of Winston and Marilyn Kloosterman of Murray Hill Drive in Canton received the Civil Engineering Academic Achievement Award. Susan is a junior.

Thomas Wolfe, son of John and Beverly Wolfe of Dorian in Plymouth, received one of the sophomore academic achievement awards.

\*\*\*\*\*

Three Cities Art Club will hold its third annual judged show April 27 through May 5 at First National Bank in Plymouth. Audrey DiMarco will judge the show.

Some of the artists exhibiting in the show will include: Audrey Paul, Dorothy Koliba, Fifi McCutchan, Martha Barnes, Cathy McClung, Cuyler McCutchan, Joyce Frederick, Ellen Kenney, Mark Michener, Hazel Rogers, Lorene Vives, Doreen Lawton, Peg Lambert, and N. C. Lopez.

\*\*\*\*\*

Place a bet on the future of our community by attending the millionaires party sponsored by Growth Works. The betting will take place this Friday night, April 27 from 8 p.m. to 1 a.m. at the Plymouth Hilton. Donation is \$5 per person with free hors d'oeuvres and a cash bar. For ticket information call Dan LeBlond at 455-6433.

## Free pap tests on May 9

The Plymouth office of the Michigan Cancer Foundation, located at 173 N. Main St., will offer a free pap test on Wednesday, May 9, from 9 a.m. until 4:30 p.m.

The Plymouth branch will extend its hours from 10 a.m. until 3 p.m.

beginning April 30. Appointments can be made at that time by calling 453-3010.

This simple, painless examination to detect cervical cancer will be given by a specially trained nurse in a few minutes for women 18 years and over.

What a  
difference a  
bouquet  
makes.

Make an arrangement with:

**heide's**  
FLOWERS



Our Friday  
Flower  
Feature.

**Mixed Spring  
Bouquet  
\$3.50**

Fresh flowers on Friday can make your weekend blossom. Stop in today and pick up a colorful, specially-priced bouquet.



453-5140

995 W. Ann Arbor Trail, Downtown

# Wife abuse: fact or fiction?

PG.  
11

BY PATRICIA BARTOLD

Wife abuse. Those chilling words. They describe everything from continual telephone harassment by an irate husband to the broken bones of a battered wife.

Two weeks ago Plymouth Township trustees awarded \$22,500 to the First Step program which is designed to help provide support for battered wives in Western Wayne County.

How widespread is the problem? "Wife abuse cuts across all economic boundaries — it happens to upper, middle, and lower class wives. It happens very frequently in suburban areas like Plymouth, Plymouth Township, and Canton," said Debbie Benjamin, a spokesperson for First Step.

Statistics from the Plymouth Police Department support her claim. She said about 21 per cent of the assaults committed in Plymouth were domestic assaults. This figure was compiled by comparing the number of domestic assaults to those that are not domestic during a four-month period in 1977.

Furthermore, she said: "For every case of domestic assault reported to the police, about 10 cases are not reported." Wife abuse is the most unreported crime in the country — even rape is reported more often, she said.

Why are wives so reluctant to report abuse? "There's a veil of privacy in the home that makes civil law seem irrelevant inside its walls.

"We live under the idea that: You made your bed, now lie in it," Benjamin said. Both of those concepts make leaving a husband, who is perhaps the father of a woman's children, very difficult, she said.

Usually the first phone call is the first step of a process that is very diffi-

cult for the wife to assume, said Benjamin, in explaining the name, First Step.

The decision — to leave the security of home and husband — is very often the hardest, she said. "Independence can be a terrifying experience," she added.

As an example, Benjamin cited the case of a woman who had been divorced for more than two years, but whose husband broke into her home and beat her up. First Step will provide the support system to help her find an attorney and prosecute him legally, said Benjamin.

She added that First Step is currently collecting data to see if there is a need for temporary shelter in western Wayne County.

Although First Step will help a woman in getting legal help or assistance in finding a job, First Step will not make decisions for wives. "We provide support, but the decision to leave or prosecute is left up to her," said Benjamin.

Why do some husbands beat their wives? "Very often, husbands who beat their wives were beaten as children by their parents," she said. They saw violence as an acceptable way to vent frustration and anger as children, so they continued it as adults," said Benjamin.

The First Step program is sponsoring the film "Turning Point" at the Penn Theater on Sunday, April 29 at 10:30 a.m. Coffee and donuts will be served at 10 a.m. Tickets for this benefit performance are on sale at Settler's General Store in the Penniman Avenue shops or at the door on Sunday morning.

Headquarters for First Step are located at Dorsey Community Center, 32715 Dorsey, Westland 48185 or by calling 595-1111.

THE COMMUNITY CRIER: April 25, 1979

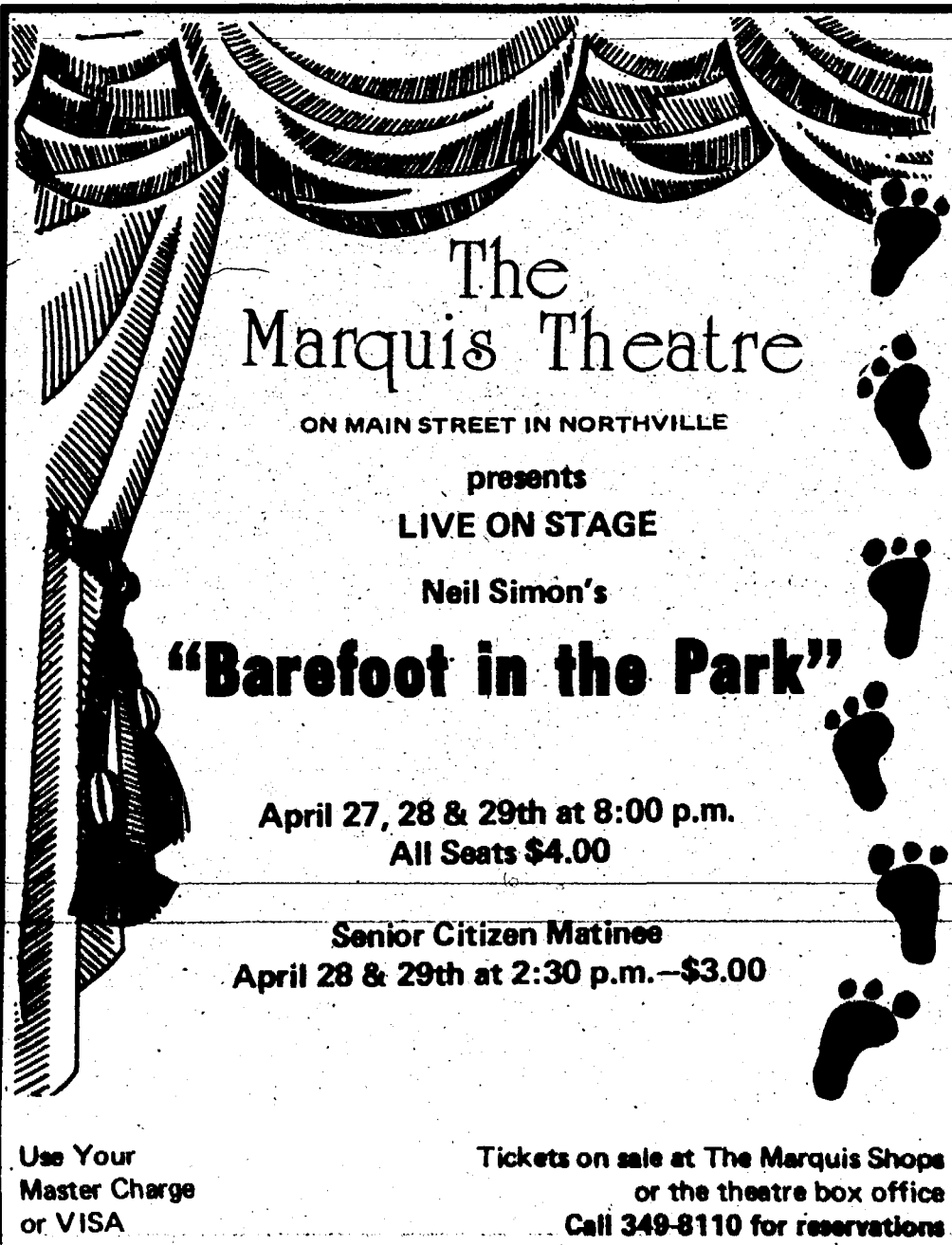

**The  
Marquis Theatre**

ON MAIN STREET IN NORTHVILLE

presents  
**LIVE ON STAGE**

Neil Simon's  
**"Barefoot in the Park"**

April 27, 28 & 29th at 8:00 p.m.  
All Seats \$4.00

Senior Citizen Matinee  
April 28 & 29th at 2:30 p.m. — \$3.00

Use Your  
Master Charge  
or VISA

Tickets on sale at The Marquis Shops  
or the theatre box office  
Call 349-8110 for reservations

## Emergency stickers here

THE COMMUNITY CRIER: April 25, 1979

Canton Township has two types of stickers now available for fire and emergency situations. One sticker indicates a senior citizen resident and the other is for an invalid resident.

These stickers should be put in two places in the residence. One sticker should be placed on the front door, to

show an invalid or senior citizen lives in the home. The second should be placed so as to indicate where within the home the person can be found.

These stickers are available at the Recreation Hall, Fire Station, and the Administration Building.

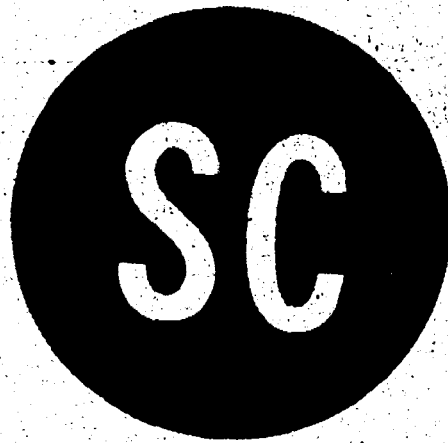

## Gibbons awarded fellowship

Pioneer Middle School Assistant Principal Patricia Gibbons has been awarded a fellowship, an honor given yearly to only a few administrators and school board members across the country.

Gibbons' fellowship is for the summer of 1980 and pays for all expenses while she studies current problems in education at Colorado College in Colorado Springs.

Gibbons received her master's degree from the University of Michigan and has also completed much of the class work for a doctorate. She has taught elementary, middle and high school courses

in English, social studies, speech and reading.

## Pops in concert

The annual Plymouth Symphony Pop Concert will be held in Pioneer Middle School at 8 p.m. on Saturday, May 5.

There will be more tickets available this year than past years, but the number is still limited. Tickets are on sale at Bed 'N Stead in Forest Place Mall. The donation for tickets is adults \$3.50 and students K-12 and senior citizens \$2.50. Reservations must be made in advance.

## what's happening

### LET'S PLAY BACKGAMMON

The American Backgammon Club is sponsoring a backgammon night on Sunday, April 29 at the VFW Hall in Plymouth. Instructions will begin at 6 p.m. with the tournament beginning at 7 p.m. For information call 459-5776.

### JAYCEES EXTEND INVITATIONS TO JOIN

Men and women between the ages of 18 and 36 can join the Plymouth Jaycees on Thursday, April 26 for a meeting at the Oddfellows Hall at 7:30 p.m. Fish and beverages will be served.

### THREE CITIES ART CLUB

The third-annual judged show for the Three Cities Art Club will be at the First National Bank of Plymouth from April 27 to May 5 during normal banking hours.

### REUNION FOR THE CLASS OF 1939

The Plymouth High School Class of 1939 will gather for a class reunion on Saturday, Oct. 20 at the Elks Club in Plymouth. For more information, contact Linnea Vickstrom Salow of Plymouth or Jennie Tallmadge at 455-0734.

### CANTON NEWCOMERS

The Canton Newcomers will meet on May 2 at Pioneer Middle School at 7 p.m.

### OPEN SKATING HOURS

The Plymouth Parks and Recreation Department announces its spring open skating hours as follows: Monday - 1-3 p.m.; Tuesday - 9-11 a.m., 1-3 p.m., 4-6 p.m.; Wednesday - 1-3 p.m.; Thursday - 1-3 p.m., 4-6 p.m.; Friday - 1-3 p.m.; Saturday - 11 a.m. - 1 p.m.; 1-3 p.m.; Sunday - 1-3 p.m.; 3-5 p.m. Dance sessions are on Tuesday and Thursdays from 11 a.m. - 1 p.m.

### PILGRIM GARDEN CLUB

The Pilgrim Garden Club of the Federated Garden Clubs of Michigan will hold its next meeting on Thursday, April 26, at 7:30 p.m. Guests and perspective members are invited.

### SPRING ROUNDUP

To enroll your child in the Plymouth Children's Co-op Nursery, come to Spring Round-up on Wednesday, May 2, Sunday, May 6, and Wednesday, May 16 from 1 to 2:30 p.m. For more information, call Betsy Mazurkiewicz at 459-3039.

### PLYMOUTH NEWCOMERS

The Plymouth Newcomers will meet on May 3 at the Botsford Inn in Farmington Hills at 11:30 a.m. for a luncheon. For reservations call Kathy at 459-4019 before May 1. Call Mary at 420-2214 for babysitting.

### ART AUCTION FOR CANTON LIBRARY

On Saturday, April 28, the Canton Library Campaign Committee will sponsor an art auction at the Canton Township Hall, third floor, 1150 Canton Center Rd. Refreshments and preview starts at 7 p.m. and the auction begins at 8 p.m.

### WOMAN'S CLUB OF PLYMOUTH

The Woman's Club of Plymouth will host a benefit luncheon and card party on Monday, April 30 at the Plymouth Cultural Center at noon. Donation is \$3.50. For tickets, call Carolyn Loesch at 453-4616, Julia Kenny at 455-0370, Maxine Jordan at 453-7437 or Dorothy Lent at 453-3430.

### CB ROAD RALLY

The Centennial CB Club is sponsoring a road rally on Saturday, May 5 at 1 p.m. at the VFW Hall on Lilley Road. For more information call 420-0614, 453-7626, or 455-2894. The rally is open to the public.

### MILLIONAIRES LAS VEGAS PARTY

Growth Works is sponsoring a millionaires Las Vegas party on Friday, April 27 at the Plymouth Hilton from 8 p.m. to 1 a.m. Tickets are \$5 per person and can be purchased from Dan LeBlond at 455-6433.

### TORNADO MOVIE

The Centennial CB Club will meet on April 28 at 1 p.m. at the Oddfellow Hall in Plymouth to see the movie "Tornado." The film is sponsored by the Plymouth Area REACT team.

### WAYNE COUNTY NUTRITION PROGRAM

The City of Plymouth, in cooperation with the Wayne County Office on Aging, offers a nutrition program Monday through Friday, at Tonquish Creek Manor, 1160 Sheridan. The nutrition program offers seniors a well-balanced meal at the site, or by calling 455-6620 from 8:30 a.m. to 5 p.m. All reservations must be made by Thursday of the preceding week. The program is free, however, a 50 cent donation is appreciated.

### SINGERS NEEDED

The Canton Township Parks and Recreation Department would like to hear from those individuals interested in forming a Canton Community Chorus. Please contact 397-1000, ext. 212, if interested. There will be an organizational meeting as soon as enough interest is shown. The chorus will also need a piano player.

### POT-LUCK FOR SENIORS

St. Michael's Lutheran Church, 700 Sheldon Road, Canton Township, is planning a series of get-acquainted pot-luck dinners to be held at 1 p.m. the second Thursday of every month. Between times this group of persons 50 and over gathers at 12:30 p.m. every Thursday for a social program. Call 397-2775 for more detail.

## Plymouth-Canton Dance Theater taps 11 local 'stars'

Eleven dancers were recently chosen to perform in the Plymouth-Canton Dance Theater, which is sponsored by the Plymouth Community Arts Council. Anne Davey, Bridgit Mulroy, Kim Schumard, Susan Thomas, Carole Jorison, Jennie Weiser, Cynthia Luce, Julie Helgren, Kristie Beaudette, Mary Posuniak, and Karla Karinen were selected to perform with the troupe.

The group is working on choreographing several dance numbers now, according to Anne Mininberg, one of the founders of the company. However, she said the company is still looking for places in which to perform. She also added the company is still open for auditions. For more information about the company, call Barb Raschke at 459-5920.



## THE JAYCEES NEED YOU!

Find out why Thursday at 7:30 p.m., April 26, the Odd Fellows Hall, corner of Elizabeth and Ann Arbor Trail. You'll find the answers to questions like: What is a Jaycee, What do they do, What is their function in the community, What will they do for me... etc.

These and any other questions you might have can be answered by any Jaycee. Any person between the ages of 18 and 36 male or female is extended this invitation. We will be there to answer any question you might have. We will also be serving fish (smelt) and beverages to everyone attending.

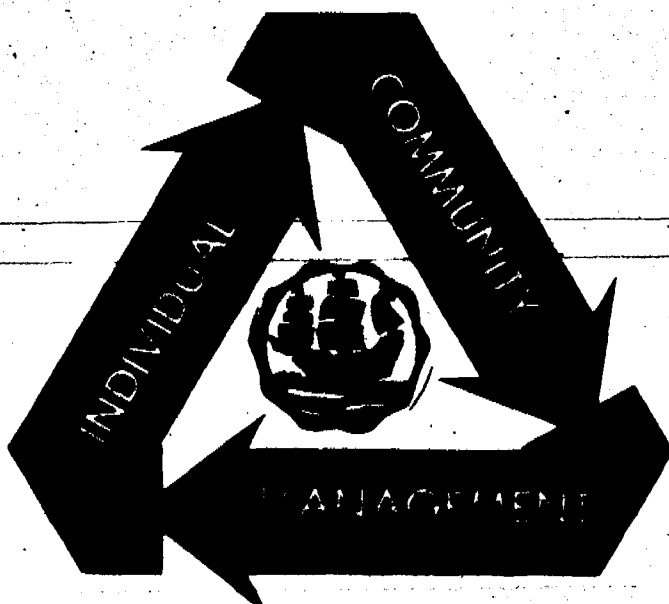

# Seniors step lively in 'Follies 79'

About 70 members of various Canton senior citizens' groups will present the musical, "Follies, '79" at the Canton High School Little Theater on Thursday, April 26 at 7:30 p.m. and Saturday, April 28 at 3 p.m.

Among the entertainers will be the Canton Seniors Kitchen Band, who will play a variety of songs on instruments such as washboards, cake tin drums, bamboo sticks, spoons, and kazoos. Songs to be featured include: "Peg O' My Heart," "Singing In the Rain," and "Put a Little Love In Your Heart."

The members of the band are: Mildred Boyes, Catherine Blake, Jay and Kay Whitehead, Iva Folts, Marie Fifelski, Agnes Hardie, Eddie and Iva Brickman, John Niemi, Martha Spiegel, Laura Sett, Susan Bence, John Brooks, Marie Martell, Silk Heim, Helen Aho, Mary Woods, Jack and Iris Ryan, Merle Hutchinson, David and Rosemary Jones, Claude and Doris Eaton, Florence Morgan, Trudy and Milt Roettger, Walter Moseby, Isabel Hafe, Ina Ross, Helen Welniak, Alice Ridley, Charlotte Schwartz, Helen Runge, Winifred Mitchell, Julie Torzynski, Lillian Lepper, Maude Truesdell, Juanita Howell, and Alice Travis.

Other acts will include a disco number by the senior dancers, humorous readings by Harold Beattie, male ballet dancers, and a musical quintet by Trudy Roettger, Claude Eaton, Ed Brickman, Walter Moseby, and David Jones.

The co-ordinator for the show is Delores Edwards. Tickets are \$1 for adults and 50 cents for children under 12. They can be purchased at the door.



*'Follies 79'*  
on stage

**SINGING IN THE RAIN.** Strolling along, twirling her umbrella is Canton senior citizen Marie Fifelski. She's backed by the Canton Seniors Kitchen Band who will perform during 'Follies '79.' The acts will be presented on April 26 at 7:30 p.m. and April 28 at 3 p.m. (Crier photo by Bill Bresler)



**WAITING BACKSTAGE.** Charlotte Schwartz, on the left, and Helen Welniak clasp hands backstage before performing in "The Waltz Quadrille." (Crier photo by Bill Bresler)

**the Cutting Quarters**  
328 South Harvey  
Downtown Plymouth  
Plenty of parking in the rear  
**459-0640**

**Laurel FURNITURE**  
BEDROOM FURNITURE  
584 W. Ann Arbor Tr.  
Plymouth  
Open Daily 9:30-6pm  
Thurs & Fri til 9pm  
**453-4700**

**Trifari Trifari Jewelry Jewelry**  
new arrivals  
Just in time for Spring and not a moment too early for Mother's Day, we're proud to present a wide array of the latest in chains, bracelets, stick pins, amulets, earrings and more.  
And where else but The Cricket Box can you purchase just \$35.00 worth of the most up-to-date jewelry and receive a \$5.00 gift certificate????  
**The house of elegant gifts...**  
**CricketBox**  
Sign up today for our unique Jewelry Club. **at home in Plymouth!**  
Fairlane Town Center Mon, Tue, Wed, Sat 9:30-6 4461 Ann Arbor Rd.  
593-4420 Thu & Fri 9:30-9:09 Plymouth 465-3332



# Lunch surplus coming

APRIL 30 TO MAY 4  
ALL LUNCHES SERVED WITH MILK  
Menus subject to change.

**ALLEN MONDAY**  
Chicken soup, toasted cheese sandwich, fruit cup.

**TUESDAY**  
Ravioli with meat, vegetable, bread and butter, fruit cup.

**WEDNESDAY**  
Spaghetti with meat sauce, vegetable, bread & butter, fruit cup.

**THURSDAY**  
Hot dog on a bun, catsup or mustard, vegetable, fruit cup.

**FRIDAY**  
Fish sticks, tartar sauce or catsup, vegetable, french bread & butter, fruit cup.

**BIRD MONDAY**  
Jelly and peanutbutter sandwich, chicken noodle soup, tollhouse bar, fruit cup.

**TUESDAY**  
Tacos with meat and cheese, pickle slices, buttered corn, fruit cup.

**WEDNESDAY**  
Meat in gravy, mashed potatoes, hot roll, fruit cup.

**THURSDAY**  
Hot dog on a bun, buttered vegetable, fruit cup, dessert.

**FRIDAY**  
Fish sticks, tartar sauce, french bread, buttered vegetables, fruit cup, dessert.

**ERIKSSON MONDAY**  
Turkey noodle soup, peanutbutter sandwich, fruit cup, cookie.

**TUESDAY**  
Turkey and gravy over mashed potatoes, hot roll, fruit cup.

**WEDNESDAY**  
Pizza with cheese, tossed salad, fruit cup, cookie.

**THURSDAY**  
Hot dog in a bun with relishes, vegetable, fruit cup, cake.

**FRIDAY**  
Tacos with trimmings, bread and butter, vegetable, applecrisp.

**FARRAND MONDAY**  
Hamburger on bun, catsup or mustard, pickle slices, corn, fruit, cookie.

**TUESDAY**  
Tacos w/meat, cheese & lettuce, peas & carrots, pudding, cake.

**WEDNESDAY**  
Spaghetti w/meat sauce, green beans, hot rolls, fruit, cake.

**THURSDAY**  
Hot dog on bun, catsup or mustard, corn, applesauce, cookie.

**FRIDAY**  
Fish pattie, french fries, tartar sauce, fruit, cake.

**FIEGEL MONDAY**  
Cheeseburgers, french fries, vegetable, fruit, cookie.

**TUESDAY**  
Soaring fish with tartar sauce, vegetables, carrot sticks, applesauce, hot rolls.

**WEDNESDAY**  
Grilled chesse with pickles, tomato soup, fruit, cookie.

**THURSDAY**  
Famous Falcon sloppy joes, vegetables, salad, pineapple upside down cake.

**FRIDAY**  
Golden oven fried chicken, mashed potatoes, vegetables, fruit, hot roll.

**FIELD MONDAY**  
Sloppy joe, french fries, fruit, cake.

**TUESDAY**  
No lunches served, In service day, P.M. only.

**WEDNESDAY**  
Pizza, vegetable, fruit.

**THURSDAY**  
Toasted cheese sandwich, tomato soup, crackers, fruit.

**FRIDAY**  
Hot dog, vegetable, fruit, cookie.

**HULSING MONDAY**  
Turkey sandwich with gravy, peas and carrots, pudding, peaches.

**TUESDAY**  
Hamburger and roll, pickle slices, french fries, toll bar, peaches.

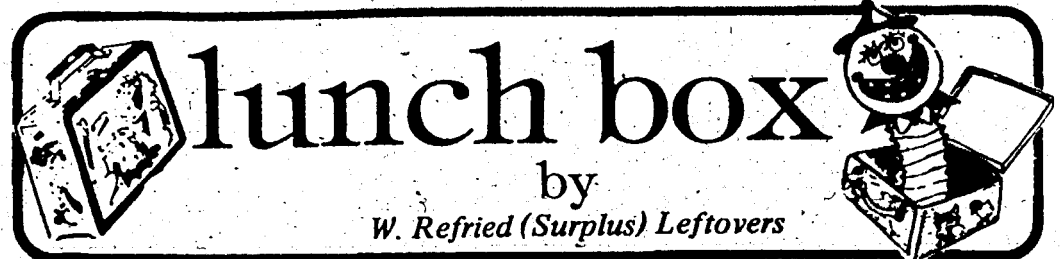

## lunch box

by  
W. Refried (Surplus) Leftovers

Ray Hoedel, assistant supt. for business, said the \$29,524 loss in the school lunch program so far this year may get better as schools use up the surplus foods they've stored.

Great! That means the leftovers from the school year thus far may be served us soon. You can only guess what concoctions that could produce.

Stay tuned to see what "surplus" foods the school cafeterias may soon be trying to pass off. Maybe there's a 25-year-old can of apple rings hiding on the shelves of Starkweather Elementary.

**WEDNESDAY**  
Pizza with meat and cheese, buttered corn, jello, fruit cup.

**THURSDAY**  
Hot dog and roll, relishes, catsup, mustard, oven baked beans, cookie, mixed fruit cup.

**FRIDAY**  
Grilled cheese or corn dog, buttered vegetables, applesauce, pudding.

**ISBISTER MONDAY**  
Submarine sandwich, mixed vegetable, fruit, cookie.

**TUESDAY**  
Hamburger gravy over mashed potatoes, hot roll, fruit cup, cake.

**WEDNESDAY**  
Goulash, buttered french bread, peas, fruit cocktail, tollhouse bar.

**THURSDAY**  
Hot dog on a bun, corn, pudding or fruit cup, cookie.

**FRIDAY**  
Pizza puff, green beans, fruit cup, butterscotch bar.

**MILLER MONDAY**  
Jennifer's Turkey & Gravy, Michelle's mashed potatoes, homemade rolls, fruit cocktail.

**TUESDAY**  
Mike's Grilled cheese, Ford's french fries, applesauce, Brian's choco chip cookies.

**WEDNESDAY**  
Jason's pizza w/cheese & pepperoni, Shawn's salad, jello.

**THURSDAY**  
Jeff's jiffy hot dogs, baked beans, choice of peaches or peaches, Berine's ice cream.

**FRIDAY**  
Christina's tacos, Tina's corn, bread sticks, celery & carrots sticks, lemon drink.

**SMITH MONDAY**  
Hamburger on bun, mustard or catsup, tater tots, applesauce, chocolate cake.

**TUESDAY**  
Sliced turkey roll, mashed potatoes & gravy, hot rolls & jelly, peaches, cookie.

**WEDNESDAY**  
Spaghetti with meat sauce, buttered bread, broccoli, jello/fruit, cookie.

**THURSDAY**  
Hot dog on bun, mustard or catsup, french fries, peaches, cake.

**FRIDAY**  
Pizza with meat & cheese, carrots, pineapple, cookie.

**STARKWEATHER MONDAY**  
Grilled cheese sandwich, carrot and celery sticks, peaches, rice krispie bar.

**TUESDAY**  
Goulash, green beans, jello, cake.

**WEDNESDAY**  
Hamburger, cole slaw, applesauce, cookie.

**THURSDAY**  
Turkey gravy over mashed potatoes, homemade rolls, cranberry jello.

**FRIDAY**  
Hot dog, tater tots, pudding, mixed fruit.

**COUPON**

**Peacock Room**

**Unisex Styling Salon**

5800 Sheldon Road  
Canton  
459-4280

**SATURDAY ONLY!!  
HAIR CUT \$5.00**

Walk ins only and no request.  
Open Sundays 9 a.m. - 5 p.m.  
Thursday Nights till Midnight  
Must Bring Coupon!

**TANGER MONDAY**  
Grilled cheese sandwich, pickle slice, soup, chilled fruit.

**TUESDAY**  
Pizza burger, potatoe rounds, chilled fruit, May Day cake.

**WEDNESDAY**  
Hot turkey gravy over mashed potatoes, cranberries, chilled pears, green jello.

**THURSDAY**  
Hamburger or cheeseburger, choice of relishes, french fries, apple krip.

**FRIDAY**  
Scrambled eggs and ham, hot buttered roll, chilled pineapple, tomato juice.

**CENTRAL MIDDLE MONDAY**  
Hot dog or burrito, buttered corn, choice of fruit.

**TUESDAY**  
Beef chop suey over rice or chicken a la king over biscuits, choice of fruit or fruity pudding.

**WEDNESDAY**  
Pizza Day.

**THURSDAY**  
Tacos with lettuce and cheese, choice of fruit, cookie.

**FRIDAY**  
Ravioli with cheese topping, choice of buttered vegetable, choice of fruit, cookie.

**EAST MIDDLE MONDAY**  
Spaghetti, roll and butter, tossed vegetable salad, applesauce.

**TUESDAY**  
Hot ham and cheese sandwich, vegetable soup, fruit, peanutbutter cookie.

**WEDNESDAY**  
Pizza, buttered green beans, apple crunch.

**THURSDAY**  
Hamburger or cheeseburger on a bun, french fries, chilled pears, tollhouse bar.

**FRIDAY**  
Fish sandwich or hot dog, tomato juice, peaches, potato chips, cookie.

**PIONEER MIDDLE MONDAY**  
Sloppy joe on a bun, buttered vegetable, fruit, cookie.

**TUESDAY**  
Sliced roast beef, potatoes and gravy, home made roll and butter, buttered vegetable, fruit.

**WEDNESDAY**  
Hot dog or chili dog, nachos, buttered vegetable, fruit, cookie.

**THURSDAY**  
Pizza burgers with meat and cheese, buttered vegetable, fruit, cookie.

**FRIDAY**  
Fish sandwich, tri taters, fruit, cookie.

**WEST MONDAY**  
Spaghetti with meat, green beans, hot biscuits, fruit.

**TUESDAY**  
Hamburger gravy, mashed potatoes, mixed vegetables, strawberry in jello, hot rolls.

**WEDNESDAY**  
Pizzaburger with cheese and meat, whole kernel corn, peaches, banana cake.

**THURSDAY**  
Hamburger with trimmings or cheeseburger, french fries, fruit or juice, butterscotch brownies.

**FRIDAY**  
Fishwich or toasted cheese sandwich, french fries, applesauce, chocolate chip cookies.

**SALEM-CANTON HIGH MONDAY**  
Beef stew with vegetables, biscuit and honey, applesauce or peaches.

**TUESDAY**  
Hot dog, chili and crackers, cake with topping.

**WEDNESDAY**  
Spaghetti with meat sauce, tossed salad with dressing, hot roll and butter, jello.

**THURSDAY**  
Taco with lettuce and cheese, vegetable, dessert.

**FRIDAY**  
Fish on a bun, potatoes, vegetable, fruit.

Ala Carte Items: Soup and sandwich, pizza, fries, hamburger, hot dogs.



## Hey Kids!

### Do you have a GREAT MOTHER?

if so win prizes for her by entering  
Harvard Square Mother of the Year contest.  
Write a letter telling why your mother should be  
the winner. Bring your letter to one of the  
following stores for judging (16 years & younger)

The participating stores and prizes to be given away as listed below.

- Peacock Room Unisex Styling Salon - Hairstyle & Makeup
- Legault's of Canton - Flowers
- Sound Station Records & Tapes - Record Album
- Cyprus Gardens Restaurant - 2 dinners
- Harvard Square Jewelers - Mother's Pendant
- Floor Fashions of Canton - Throw rug
- Masters of Dance Arts - Dance lessons
- Canton Sports - Gift Certificate

Deadline for entries is May 7, 1979.

**HARVARD SQUARE-Ford at Sheldon**

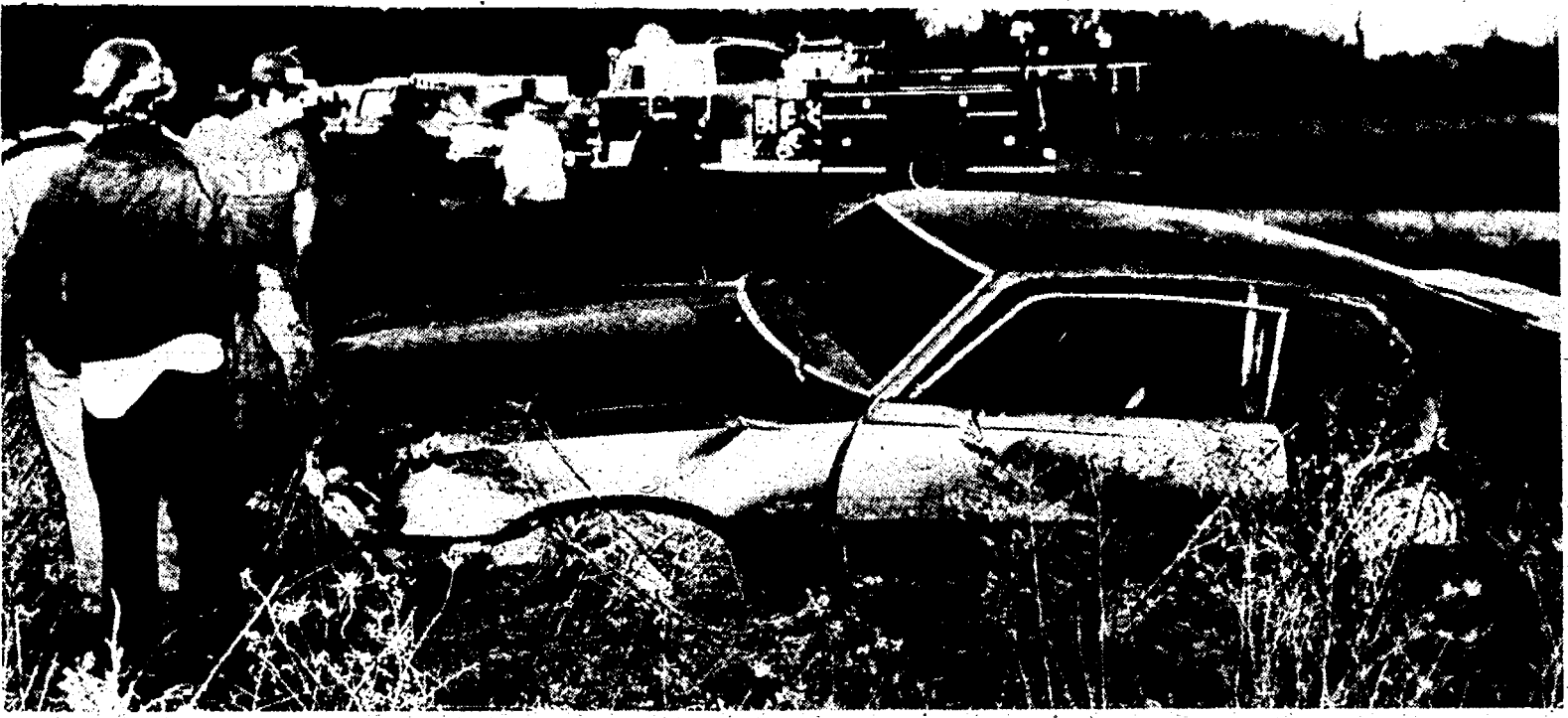

### Youth injured

A ROLLOVER. Sixteen-year old Larry Strine of Ypsilanti was injured when his Maverick rolled over at the intersection of Cherry Hill and Gotfredson roads on Monday evening, said the Washtenaw County Sheriffs Department. Strine was not ticketed, said sheriffs. (Crier photo by Bill Bresler)

### A review

## Symphony braves heat, squeaky chairs

BY P.D. MORSE

It was a warm spring day Sunday and Plymouth-Cantonites had thawed out enough to attend the Plymouth Symphony Orchestra's performance. They were rewarded with a selection by Debussy, one by Brahms, and a piano concerto by Rachmaninoff.

Debussy's "Symphonic Fragments from 'Le Martyre De Saint Sebastien'" is a beautiful and complex piece and it was performed well by the orchestra. The violins sounded thin and the two violin sections had some problems coordinating their simultaneous entrances but these were minor problems and were offset by the fine music of the English Horn played by Kristy Meretta.

The sound selection, Brahm's "Symphony No. 1 in C Minor, Opus 58" was even better. In this piece, the orchestra had a very full and powerful sound. The orchestra seemed to pull together during the louder passages but did not become ragged when the music softened. Emily Mutter-Austin also provided some fine solo passages. The

audience responded with vigorous applause and Wayne Dunlap and Mutter-Austin took well-deserved bows.

The final piece, Rachmaninoff's "Concerto No. 2 for Piano and Orchestra, Opus 18," was by far the best performance of the afternoon. The pianist was Frederick Weldy. Weldy has a Masters Degree from the University of Michigan School of Music in piano performance and is the recipient of numerous awards and scholarships.

Currently living in New York City, Weldy returned to Michigan to play with the Plymouth Symphony Orchestra and gave an outstanding performance. The concerto is a moving and elegant piece and was an excellent vehicle for Weldy, who brought an immense depth and intensity to the music. The orchestra responded in kind.

Weldy was given a standing ovation and returned to thank the audience twice.

The Plymouth Symphony Orchestra has played the last several seasons in the Plymouth-Salem High School Auditorium.

This provides adequate seating and reasonable acoustics. Few people sit in the balcony which is surprising since the view of the orchestra is better and the sound is much stronger and more uniform.

A major shortcoming is the heating and cooling system which has been either too cold or too hot (as it was last Sunday). The squeaky chairs are also an unnecessary and irritating distraction.

It is common for people to bring children, and this should be encouraged in a community-sponsored venture. These children may someday be playing in the orchestra. It is too much to ask that they not move throughout the entire concert, and even small movements result in big squeaks. Perhaps by the next season, the chairs can be properly lubricated.

The final performance by the orchestra is the Pops Concert which will be held at Pioneer Middle School, Saturday, May 5 at 8 p.m. Tickets are \$3.50 and are available at Bed 'n' Stead.



## Cubs sell geraniums

LOCAL Cub Scouts will peddle geraniums door-to-door in some neighborhoods on May 12 to raise money for scouting activities. The plants cost \$1.25. Eric Swanson, on the left, and Mike Laurette are ready to sell some plants. Both are fourth-graders at Bird School.



# Get The Crier

If you aren't getting "The Newspaper with Its Heart in The Plymouth-Canton Community" delivered to your door each Wednesday, you can buy a copy at one of the following fine outlets:

### City of Plymouth

- Community Crier Building, 1226 S. Main St.
- Wiltzie's Pharmacy, 330 S. Main St.
- Penniman Market, 820 Penniman Ave.
- Mayflower Hotel, 827 W. Ann Arbor Tr.
- Bill's Market, 584 Starkweather
- Beyer Rexall Drugs, 4800 N. Main
- Plymouth Book World, 470 Forest 7-11 Store, Main St.
- Cloverdale Dairy, 447 Forest Ave.
- Mayflower Party Shoppe, 824 Main

### Plymouth Twp.

- Little Professor Books, 1456 Sheldon Rd.
- Sav-On Drugs, 4485 W. Ann Arbor Rd.
- Beyer Rexall Drugs, 1100 Ann Arbor Rd.
- McAllister's Party Store, 14720 Northville Rd.

### Northville Twp.

- Cap & Cork, 40644 Five Mile Rd.

### Canton Twp.

- Dennis' Market, 6140 Canton Center Rd.
- Julien's Market, 2249 Canton Center Rd.
- Book Break, 44720 Ford Rd.
- Harvard Square Book Store, 5844 Sheldon Rd.
- Star Stop Party Store, 42444 Ford Rd.
- Richardson's Pharmacy, 42432 Ford Rd.
- Quik-Pik Store, 7399 Lilley Rd. - Kings Row

For even more enjoyment out of your Crier, you can get home delivery by calling 453-6900.

# Standard Federal Savings

# Announces the Grand Opening

## of the new Plymouth Township Office

# Receive a free ONEIDA Gift...

For a deposit of \$500 or more to a new or existing account choose

- 1 Chippendale Compote
- 2 Chippendale Bon Bon Dish
- 3 Paul Revere Bowl (6")
- 4 Round Tray (10")

one of these free Oneida silverplate gifts.



Or deposit \$5,000 or more in a new or existing account and receive one of these beautiful Oneida



# Tonic

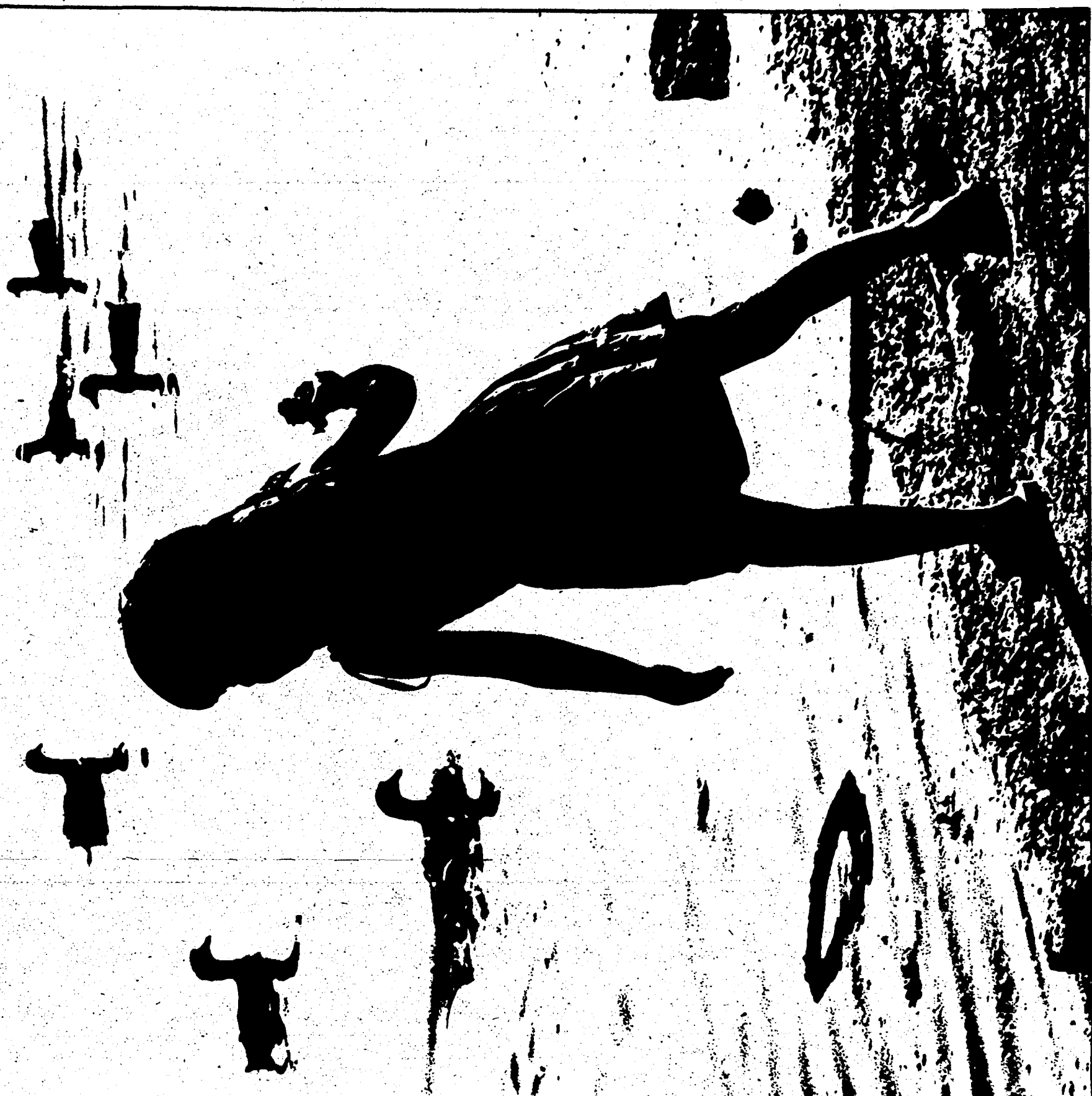

# Spring Sale



PRO advice, plus a real good price.

Bud Wilkinson for PRO.



**PROMART**  
HOME CENTER

HARDWARE STORES

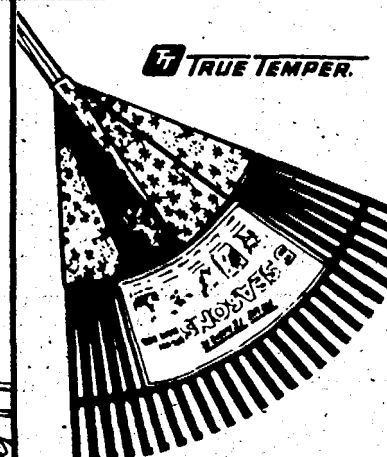

**HEAVY DUTY LEAF AND LAWN RAKE**  
**3.99**

Strong and durable one piece construction of molded polypropylene makes this a perfect all purpose leaf and garden rake, season after season! Large 24" size. (49)

## FIX-IT YOURSELF

**STANLEY**  
QUALITY SCREWDRIVERS  
**WORKMASTER**  
4 PIECE SET  
**5.99**

AS SEEN ON TV



**FREE**  
from STANLEY  
**SCREW HOLE STARTER!!!**  
When you buy 4-piece screwdriver set.

A set of four Stanley screwdrivers with plastic handles, full-size comfortable grip and forged hardened steel blades for any job around the house. (7)



**24 PIECE TOOL KIT**  
**24.99**

A value-packed Thorsen home-and-auto tool kit. Includes three-eighths reversible ratchet and extension; 12 socket wrenches, including a sparkplug socket; two screwdrivers; five open-end wrenches; an 8-inch adjustable wrench; and pliers. The ideal gift. Use for home, auto, boating, motorcycles and bikes. Full Lifetime Warranty. (204)

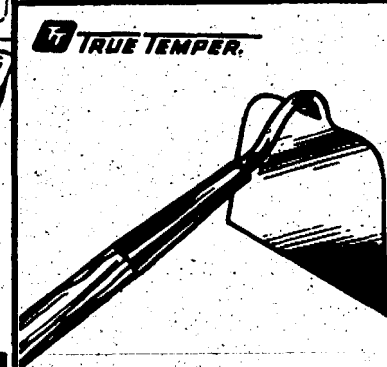

**GARDEN HOE**  
**4.69**

Great for all your gardening needs. Welded shank. 6 1/4" x 4 1/4" blade. Ash handle. (44)

**FREE Lufkin CAP** WHEN YOU BUY A 16 FOOT LUFKIN TAPE MEZURLOK  
**6.99**

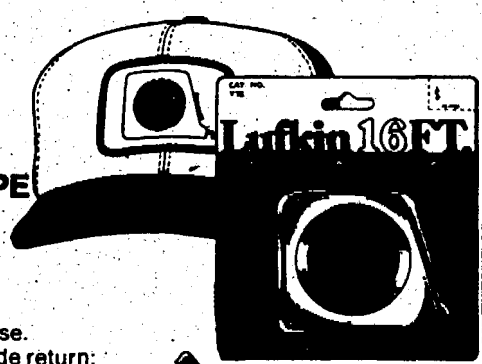

Lightweight, rugged chrome case. Patented bumper cushions blade return; reduces end hook breakage. Removable belt clip. (76)

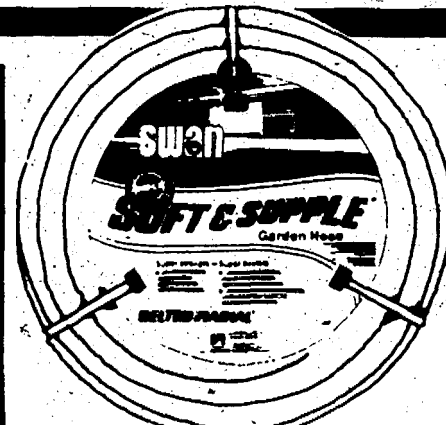

**SWAN 5/8" x 50' FLEXIBLE GARDEN HOSE**  
**14.99**

Extra soft cover for year-round handling ease. Stays flexible below zero. Belted radial dual reinforced hose for extra strength. Solid brass couplings. (64)

**DIAL-CONTROL SETTING OSCILLATING SPRINKLER**  
**3.99**

Choice of multiple positions. Coverage up to 2200 sq. ft. High impact Cycloac plastic housing. (63)

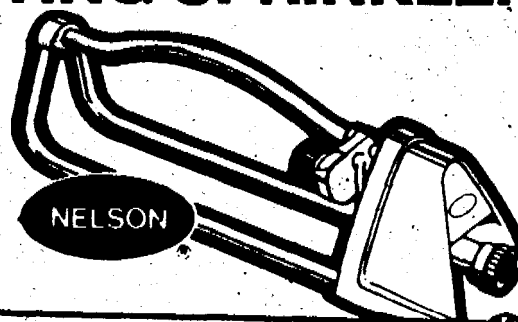

**Bostik WORKSHOP "POP" RIVET TOOL**  
**4.99**

Multipurpose Rivet tool for professional do-it-yourself results. Sets 1/8", 5/32" and 3/16" "POP" Rivets. Interchangeable nosepieces and nosepiece wrench included. (75)

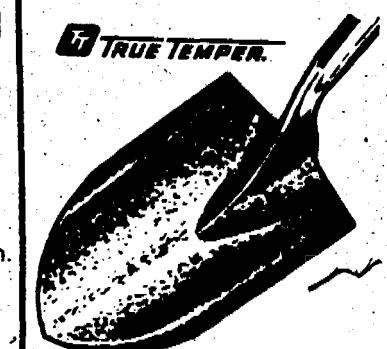
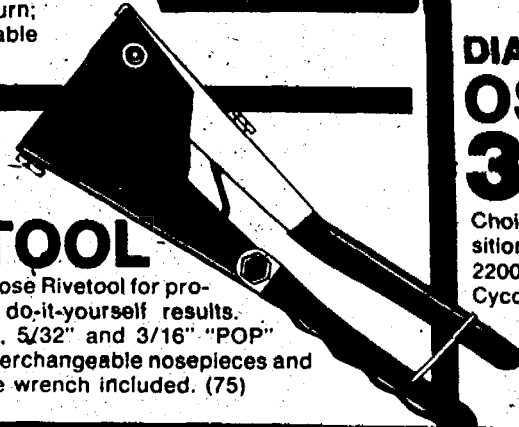

**LONG HANDLE DIRT SHOVEL**  
**4.99**

Long handle, round point. Extra light weight but with strength built-in. For general purpose use. An outstanding value. (45)



# S & W PRO HARDWARE

875 ANN ARBOR RD. • PLYMOUTH • GL 3-1290

HOURS; DAILY 9-8; SAT. 9-6; SUN. 10-4

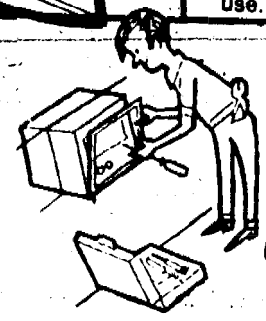

# Spring sprouts planting projects for clubs

BY PHYLLIS REDFERN

Spring is the busiest time of year for all the local garden clubs, as they take to the outdoors toting their garden tools.

Plymouth Garden Club (a branch of the Womens National Farm and Garden Club) is planting a tree at Centennial Educational Park as their spring project. They will also be planting 1,000 seedlings with the help of second graders in the local schools.

Officers in the Plymouth Club are: Beverly Booker, president; Mary Weed, first vice president; Mariam Waterhouse, second vice president; Mary Wallace, recording secretary; Sue Griebel, corresponding secretary; Elaine Pierce, Treasurer; and Helen Bilyea, director.

Pilgrim Garden Club will be working on beautifying the library again this year. Along with the flowers and shrubbery, the club will be putting in a bird bath. Officers in the Pilgrim Garden Club are: Dianne Bodell, president; Nancy Chapman, vice president; Nancy Zelak, secretary; and Donna Sarrach, treasurer.

Apple Run Garden Club recently donated dog food and cat food to the Kindness Center, a branch of the Humane Society. Their main spring project will be working with the elderly at Dionne Nursing Home in Canton, where they will plow an area and give them seeds to plant their own garden. The club will also be doing some work around the new administration building in Canton.

The new officers who were recently elected in the club are: Margo Whiting, president; Joyce Ankofski, first vice president; Esther Wilcox, second vice president; Rosemary Hahn, recording secretary; Cheryl Wachlarz, corresponding secretary; Sandy Reid, treasurer; and Ellen Brindley, member at large.

The Pilgrim Garden Club has a number of projects planned for the Dunning-Hough Library in the upcoming season.

First, a new planter bench will be built by Roy Chapman Sr. and Roy D. Chapman and placed at the back of the library. And a matching garden bench will be purchased and placed on the library porch. It will match the concrete bench bought last year.

The library will also be gussied up with other improvements: new flowers in a hanging basket at the back of the library; flowers in the landscaped

front of the library; and new plantings in the urns of the library's porch. During the summer, club members will take turns weeding and keeping the landscape neat.

Co-chairman of the library projects are Nancy Chapman and Diane Michaelson.

## Cantonites may claim garden plots soon

When weather permits, Canton residents may choose a garden plot on the township lot at the southeast corner of Lilley and Warren roads.

The lot will be staked out into about 200 25 by 50-foot lots when it dries out, said Recreation Superintendent Mike Gouin. "It was turned over last fall, so it should be all set in a couple of weeks," he added.

Once the plots are staked out, residents can choose the one they want and contact the recreation department. Some plots were claimed last year but weren't used, so Gouin urges only serious gardeners to apply.

This year, the township will erect a spigot on the site for gardeners to fill pails to water their plots. Also, gardeners will be charged \$1 this year.

For more information, call the rec department at 397-1000.

## Twp.'s Sharland to host rep

Rep. George Cushingberry (D-Detroit) accepted congratulations from Wayne County President Richard Sharland, who presented him with a membership in the Wayne County Farm Bureau.

In mid-July of this year Rep. Cushingberry will be given a tour of Wayne County farms. At this time he will be viewing different commodities that grow well in our area, the harvesting and marketing end of being a farmer.

THE CRIER: Spring Tonic, April 25, 1979

**Saturday, April 28th**  
and  
**Sunday, April 29th**  
From 10am to 3pm

**JOHN DEERE WEEKEND FREEDOM TIME OPEN HOUSE**

**FREE Gifts and Refreshments for all!**

**SAVE \$100 to \$120**

**New Lawn Tractors with Rear Bagger**

Optional rear bag holds four bushels. Fits both lawn tractors — the 8-hp 108 with 30-inch mower and the 11-hp 111 with 38-inch mower. Both tractors have 5-speed transmission.



**SAVE \$75<sup>00</sup>**

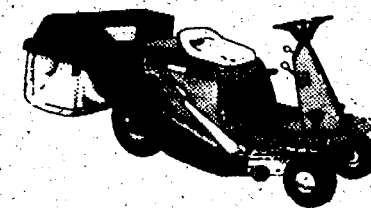

**8-hp Rider with Rear Bagger**

The John Deere 68 Rider with a 30-inch mower can use a grass bagging attachment that mounts behind the rider for greater maneuverability and close-in trimming.

**FREE REAR BAGGER**  
Deluxe 21-inch Mowers

Two models — push-type and self-propelled.

Push-type has 3½-hp engine, self-propelled has 4-hp engine and rear-wheel gear drive.

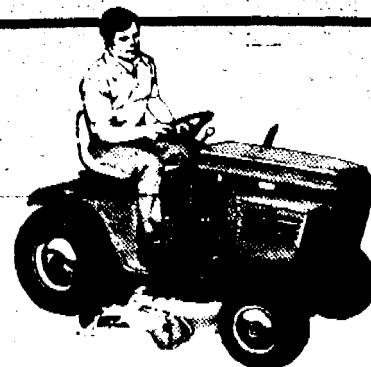

**Spring Sale!**  
on All Lawn & Garden **TRACTORS**

from 10-hp to 19.9 hp.

**CANTON POWER EQUIPMENT**  
46600 Ford Rd. (½ mile west of Canton Center Rd.) 453-0295



**Nothing runs like a Deere®**



# Five gardens keep Pat Robinson busy

BY PATRICIA BARTOLD

Ask Pat Robinson of Plymouth how her garden grows and she'll probably ask you — "Which one?" Pat, a member of the Pilgrim Garden Club, has more than one outdoor garden. She has five gardens.

Two of her gardens — the rock-garden and the everlasting garden — are near the back door. Her herb garden, which is the biggest, stretches along the side fence of the backyard. The wildflower garden is nestled under the shade of a small maple tree and, last, but not least, her vegetable garden with its beans and tomatoes, grows by the back fence.

Squatting amidst the rock garden is a statue of Pan, the god of streams, nature, and gardens. Pan is a three-foot tall white statue of a Buddha-like who plays pipes. He overlooks all the plants and insures a good growing season.

But Pat doesn't rely on the goodness of Pan to nurture her gardens. Instead, she relies on planning ahead and hard work. She's used to getting dirt under her fingernails.

Pat started planning her gardens in December, 1976 when she became interested in herbs. She decided to plant one the following spring.

Before planting, she mapped out a brick sidewalk which weaves in and out of her gardens. The walkway, which is made of bricks which were left over from a wall which caved in at their house, makes each plant accessible for weeding.

The location of each garden is significant. For example, the everlasting garden which has chives, thyme, oregano, parsley, sage, and horgound plants as well as a variety of flowers was planted next to the kitchen door. Since it's nearby, Pat can dash out to snatch a leaf or two of oregano for a pot roast or she can arrange a bouquet of flowers quickly for a friend.

Also, the plants in the herb and rock gardens are arranged by height, color, and shape. An old cow's skull has been set on the edge at the front of the rock garden. Green sedums grow from the eye sockets and nostril.

Then there's the "funeral rock" — as Pat calls it. Jenny and Taylor, the Robinson's cocker spaniels, were buried there years ago. For Pat, each rock in the garden has its own story to tell.

Pat has planted about 15-20 kinds of plants in the rock garden including: lady's mantel, choral garden, dog violet, sedum, candy tuft, and wishbone flowers.

She has planted perennials in the herb garden. They require less work



PAT ROBINSON

and come up year after year without replanting. The herbs are mostly culinary herbs for cooking or aromatic, ornamental herbs. Most are silver-colored or have silver-backed leaves.

In the herb garden, Pat has planted mint, thyme, lamb's ears, veronica, mugworts, lambrook silver, southernwoods, wormwood, yellow adder tongue, wild columbine, Lady Gray Plymouth, blood roots, virginia waterleaf, wild ginger, and wild columbine.

Village **COMING**  
Fireplace **MAY 1st!**

—Featuring—

<b>Fireplaces</b>	Pre Way Heatilator Majestic Woodside
<b>Glass Doors</b>	Thermorite Pacific Portland Hearthcraft

**Wood Burning Stoves**  
**Barbecue Grills**  
**Tool Sets**  
**& Alternative Energy Sources**

Village Fireplace

Sheldon at Ford Rds. Harvard Square



WAGENSCHUTZ  
LAWN SPRAYING

- \*Liquid Fertilizer
- \*Insect Control
- \*Weed Control
- \*Crab grass Control
- \*Fungus Control

SERVING CANTON & PLYMOUTH

81 3-1578  
or Call Plymouth 453-2280  
P.O. Box 225—Plymouth, Mich.

"25 Years Experience"  
CALL FOR FREE ESTIMATE

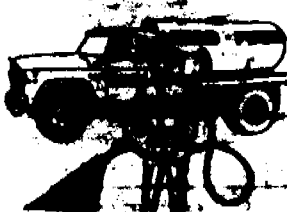

# Antje Wolfe has a very violet thumb



ANTJE WOLFE

How can you tell a male and female African violet apart? Look carefully and you may notice the difference. Females have scalloped edges and the leaves have distinct white centers; males have plain leaves that are entirely green.

Antje Wolfe of Canton takes care of about 250 African violets in her basement. They are stacked on trays under lamps and each plant is a different variety.

Since there are more than 25,000 varieties, Antje said she only cultivates for a very small proportion. She's cared for them for three years and admits their bright colors are like "tranquilizers" to her sometimes. Sometimes it's very soothing to come down and care for the plants and see their bright colors, she said. Her violets are mostly pinks;

lavenders, and various shades of deep purple.

She said African violets are very easy to keep and require only light and fertilizer. She keeps the overhead lights on for 12 hours each day, and has found that African violets don't like direct sunlight. She tends her flowers about five hours each week - watering them, trimming them, and, yes, talking to them.

Her violets have names. There's Coral Queen, Sam, White Cocatue, Song Sung Blue, Jean Garner, and Viola Tucker to name a few. She chides them, praises them, and cajoles them as she waters the wicks, trims, and rearranges them. The wicks continually hang in water which insures the plant has enough water.

Antje is a member of the Pilgrim Garden Club.

COOL, CASUAL AND COMFORTABLE.

PUT ON LUXURY GAB®

BY HAGGAR,

AND PUT IT ALL TOGETHER.

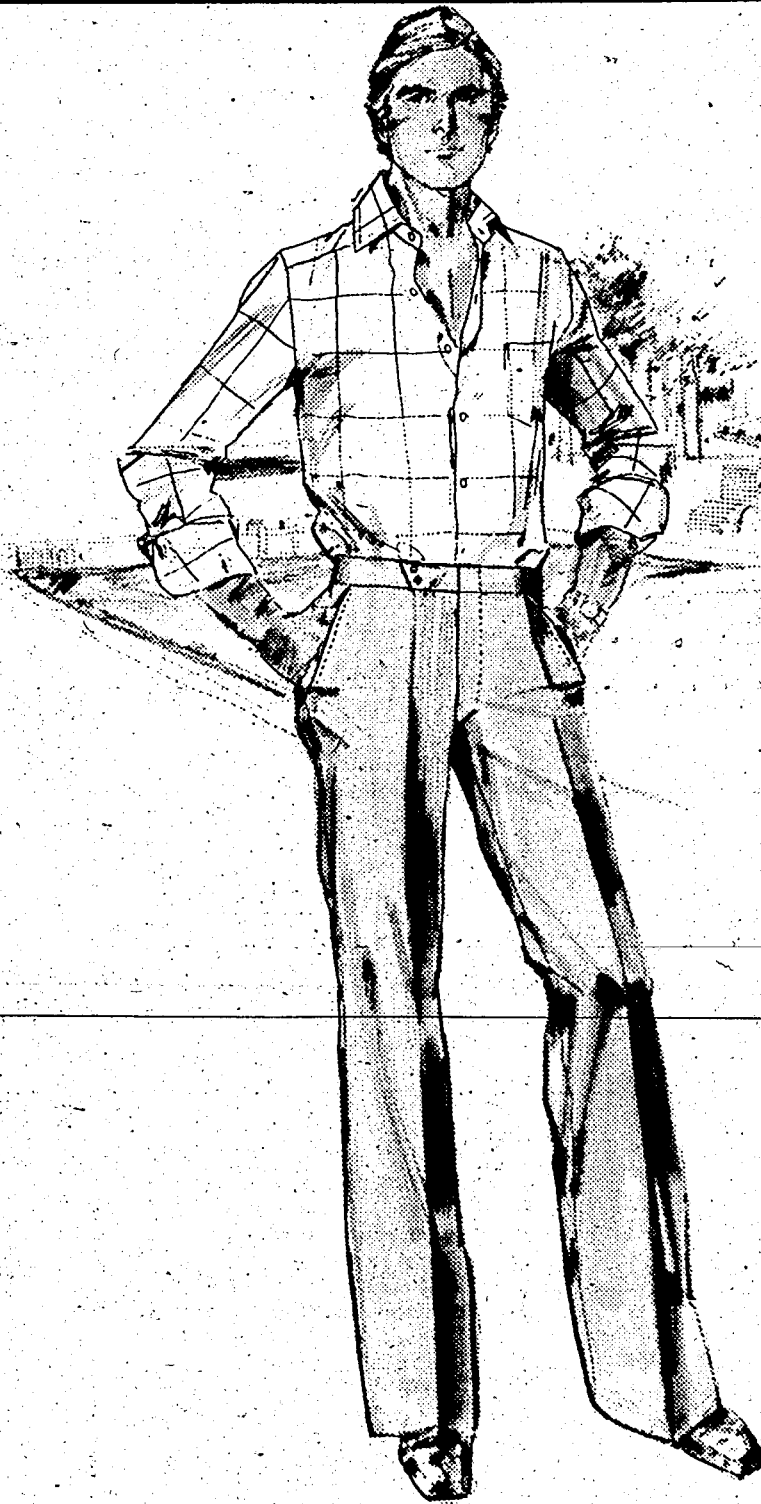

For the man who wants to feel as good as he looks, Hagggar® tailors 100% Today's Dacron® polyester into this pair of Luxury Gab® slacks. They feature the deep-inside Expand-O-Matic® waistband that bends and stretches with you. Choose your exact size in a variety of colors at a price that's as comfortable as the fit: \$25.

HAGGAR

# FAMOUS

MENS WEAR

DAILY 9:30-6  
FRI. 9:30-9

924 W. ANN ARBOR TRAIL  
PLYMOUTH

453-6030

BANKAMERICARD, MASTERCHARGE, DINERS, AMERICAN EXPRESS

## PLYMOUTH NURSERY



COMPLETE GARDEN CENTER  
QUALITY NURSERY STOCK  
DESIGNING AND PLANTING

### Spring is Planting Time

We have the largest selection of plant material in Western Wayne Co. See us for all of your planting needs, from small potted shrubs to large shade trees.

Flowering Shrubs for Specimen or Screen

<b>VIBURNUM DENTATUM</b> .....	4-5 ft.	<b>\$18<sup>95</sup></b>
Grows to 8 to 12 ft. high, creamy white flower clusters, early June, dense upright habit, excellent screen.	B & B	
<b>MACFARLANE LILAC</b> .....	3-4 ft.	<b>\$14<sup>95</sup></b>
Upright, bushy, showy, deep red-pink flowers in June.	B & B	
<b>VIBURNUM "MOHICAN"</b> .....	3-4 ft.	<b>\$15<sup>95</sup></b>
Grows to 15 ft. Dense, deep green foliage, orange-red fruit in Fall, creamy white flower clusters.	B & B	
<b>CISTENA PLUM</b> .....	4 ft.	<b>\$11<sup>95</sup></b>
Crimson leaves, small profuse white flowers in Spring. Excellent contrast plant. Fast grower.	Potted	
<b>ZABELI HONEYSUCKLE</b> .....	3-4 ft.	<b>\$8<sup>95</sup></b>
Upright spreading habit, fragrant white flowers, red berries in Fall attract birds.	B & B	

Many other larger sizes and varieties available

PLYMOUTH NURSERY THE PROFESSIONAL ALTERNATIVE

9900 ANN ARBOR - PLYMOUTH RD. (M14)  
7 MILES EAST OF U.S. 23, 5 MILES WEST OF SHELDON

OPEN DAILY 9-6  
SUNDAY 10-6

ph. 453-5500



**MAY**

**1979**



# THE COMMUNITY CALENDAR

SUNDAY	MONDAY	TUESDAY	WEDNESDAY	THURSDAY	FRIDAY	SATURDAY
		<b>1</b> Plymouth Community Chorus 8-10 p.m. East Middle School Ply. Kiwanis 6:30 p.m. Mayflower Hotel Creditors 12:30-3 p.m. Elks Club	<b>2</b> Ply. Childrens Co-op Nursery Spring Round up, 1-2:30 pm Info. 459-3039. Canton Newcomers 7:30 p.m. Pioneer Middle School Sociologist Club of Plymouth Board 7 a.m. Mayflower Hotel Senior Citizens Happy Hour Cultural Center 12-4 p.m. Canton Chamber noon - Roman Forum	<b>3</b> Senior Citizens Party Bridge Cultural Center 1-4 p.m. Ply. Senior Citizen Club 1-4 p.m. Tonquish Manor Colonial Kiwanis 12:05 Mayflower Hotel Ply. Senior Citizen Club 1-4 p.m. Tonquish Manor Plymouth-Canton Com. Chambers of Commerce and Plymouth-Canton Com. Schools Education Mtg. - 8 am, Plymouth Canton Administrative Offices Conf.	<b>4</b> Plymouth Rotary 12:05 Mayflower Meetinghouse Plymouth Theatre Guild presents "Play It Again Sam" 8 p.m. Central Middle School Parents w/o Partners 8:30 p.m. Oddfellows Hall Special Olympics Track Meet & Swimming - Civitan John Glenn High School 9 a.m. Pioneer Canton Senior Citizens 12:30-4 p.m. Rec. Center	<b>5</b> Ply. Symphony League Pops Concert. Gypsy theme 8:30 p.m. Pioneer Middle School Plymouth Theatre Guild presents "Play It Again Sam" 8 p.m. Central Middle School
<b>6</b> Parents w/o Partners Family activity - to Greenfield Village 1 p.m. Ply. Childrens Co-op Nursery Spring Round up, 1-2:30 pm Info. 459-3039	<b>7</b> Recovery Inc. 8 p.m. Central School Ply. Community Arts Council - PCAC office 9:30 Optomist Club 7 p.m. Mayflower Hotel Canton Rotary noon - Roman Forum Pilgrim Shrine No. 55 7:30 p.m. Grange Hall Canton Kiwanis 6:30 p.m. Roman Forum	<b>8</b> Senta Van Senior Cit. to Westland. Call 455-6620 Ply. Community Council on Aging 7:30 p.m. Central Middle School Ply. Community Chorus 8-10 p.m. East Middle School Ply. Kiwanis 6:30 p.m. Mayflower Apple Run Garden Club Installation Dinner. Hillside Inn 7 p.m. (no guests) Creditors 12:30-3 p.m. Elks Club Ply. Chamber of Commerce noon.	<b>9</b> CANTON SPECIAL ELECTION - polls open 7 a.m.-8p.m. Senior Citizens Happy Hour Cultural Center 12-4 Plymouth/Northville/Canton Girl Scout Recognition Meeting, West Middle School, 7-9:30 pm.	<b>10</b> Ply. Senior Citizen Club 1-4 p.m. Tonquish Manor Ply. Historical Museum 7:30 p.m. at Museum Senior Citizens Party Bridge Cultural Center 1-4 p.m. Colonial Kiwanis 12:05 Mayflower Hotel Community Fund 8 a.m. Chamber Conference Ply. Senior Cit. Club 1-4 p.m. Tonquish Manor	<b>11</b> Plymouth Rotary 12:05 Meetinghouse Pioneer Canton Senior Citizens 12:30-4 p.m. Rec Center	<b>12</b>
<b>13</b> Sun. May 13-18 Small Business Week.	<b>14</b> Toastmaster International 6:30 Mayflower Hotel Recovery Inc. 8 p.m. Central School Ply. Branch of Farm & Garden Club. Noon - home of Mrs. Louis Truesdell Canton Rotary noon - Roman Forum Canton Kiwanis 6:30 p.m. Roman Forum Plymouth Jaycees 7:30 p.m. Oddfellows Hall	<b>15</b> Plymouth Theatre Guild 8 p.m. Central Middle School Ply. Community Chorus 8-10 p.m. East Middle School Ply. Kiwanis 6:30 p.m. Mayflower Hotel Creditors 12:30-3 p.m. Elks Club	<b>16</b> Senior Citizens Happy Hour 12-4 p.m. Cultural Center MACLD 7:30 p.m. Pioneer Middle School Ply. Childrens Co-op Nursery Spring Round up, 1-2:30 pm Info. 459-3039.	<b>17</b> Plymouth Civitans 7 p.m. Hillside Inn Ply. Senior Citizens Club 1-4 p.m. Tonquish Manor American Assoc. of University Women. 7:30 p.m. West Middle School Senior Citizens Party Bridge Cultural Center 1-4 p.m. Plymouth Chamber Board meeting 7:30 Chamber Conference Colonial Kiwanis 12:05 Mayflower Hotel Ply. Senior Citizens Club 1-4 p.m. Tonquish Manor	<b>18</b> Plymouth Rotary 12:05 Meetinghouse Parents w/o Partners 8:30 p.m. Oddfellows Hall Pioneer Canton Senior Citizens 12:30-4 p.m. Rec Center	<b>19</b> Thurs. May 17 to Sat. May 19 Poppy Days.
<b>20</b> Parents w/o Partners Family activity - Roller Skating 7 p.m. Information call 455-1255	<b>21</b> Plymouth Symphony League Luncheon - noon Mayflower Plymouth Business & Professional Women's Club 6:30 p.m. Hillside Inn. Optomist Club 7 p.m. Mayflower Hotel Registered Nurses Assoc. 20th Anniversary Dinner Canton Kiwanis 6:30 p.m. Roman Forum Daughters of Am. Revolution Luncheon. Greenmead Hill House Museum - noon	<b>22</b> Senta Van Senior Cit. to Livonia. Call 455-6620 Plymouth Community Council on Aging 7:30 Central Middle School Ply. Community Chorus 8-10 p.m. Central Middle School Ply. Kiwanis 6:30 p.m. Mayflower Hotel Creditors 12:30 p.m. Elks Club	<b>23</b> American Association of Retired People. Bag lunch-Singalong. Noon -Cultural Center Senior Citizens Happy Hour 12-4 p.m. Cultural Center Tiger-Yankee Baseball sponsored by Canton Chamber of Commerce	<b>24</b> Senior Citizens Party Bridge 1-4 p.m. Cultural Center Pilgrim Garden Club Ply. & Canton 7:30 p.m. Hulsing School Ply. Senior Citizens Club 1-4 p.m. Tonquish Manor Colonial Kiwanis 12:05 Mayflower Hotel Ply. Senior Citizens Club 1-4 p.m. Tonquish Manor	<b>25</b> Plymouth Rotary 12:05 Meetinghouse Pioneer Canton Senior Citizens Club 12:30-4 p.m. Rec Center	<b>26</b>
<b>27</b> Parents w/o Partners Family activity - Bowling Plaza Lanes 11 a.m.	<b>28</b> MEMORIAL DAY BANK CLOSED Parents w/o Partners Family picnic. Dawn to dark. Huron Metro Park. Info. 455-1255 Plymouth Jaycees 7:30 Oddfellows Hall	<b>29</b> Ply. Community Chorus 8-10 p.m. East Middle Sch. Ply. Kiwanis 6:30 p.m. Mayflower Hotel Creditors 12:30-3 p.m. Elks Club	<b>30</b> Senior Citizens Happy Hour 12-4 p.m. Cultural Center	<b>31</b> Plymouth Senior Citizens Club 1-4 p.m. Tonquish Manor Colonial Kiwanis 12:05 Mayflower Hotel Senior Citizens Party Bridge 1-4 p.m. Cultural Center		

This is your Community Calendar, designed to make it easier and more convenient for you to keep up with events in the Plymouth-Canton area. Look for it on the last Wednesday of every month in The Crier.

And when it comes to making your financial affairs easier, we hope you'll stop by either of our branches... where you can find services like minimum balance no-charge checking, 5.20% Effective Annual Yield on regular 5% savings, low interest instalment loans, safe deposit boxes and a lot more. Including a friendly staff of helpful FNB people who want to make banking as pleasant as they can for you.

Stop by soon!



## FIRST NATIONAL BANK OF PLYMOUTH

Main Office: 535 South Main, 459-9000  
Ann Arbor Rd. Office: 39475 Ann Arbor Rd., east of I-275  
Member FDIC

### HOW TO LIST YOUR GROUP'S HAPPENING

If you're having an event of interest or importance to the community at large, simply submit information about it in writing to the Community Crier, 572 Harvey Street, in Plymouth by the Thursday preceding the last Wednesday of the month.

There will be no charge for items of civic, cultural, school or service club note. For further information, call The Crier at 453-6900.

### EMERGENCY PHONE NUMBERS

#### POLICE

City of Plymouth	911
State Police	348-1505
Wayne County Sheriff	721-2222
Canton Police	397-3350

#### FIRE-AMBULANCE

City of Plymouth	911
Plymouth Township	453-2545
Canton Township	981-1111



# Canton's Schultz farm starts spring planting



**DOWN THE CHUTE.** Farmer Roy Shultz, on the tractor, looks on as Phil Hall, Bob Sonnenberg, Mark Jones and Dave Wheeler feed the cabbage onto the chute.



**MARK JANOS**



**LOADING.** The young farmers inserted these cabbage shoots into the automatic planter last week at the at the Roy Shultz in Canton.

*Crier photos by Bill Bresler*



**AT THE SCHULTZ farm in Canton, balmy weather meant getting out the farm equipment to begin preparing the soil for planting.**



## 'Agriculture Understanding Day'



Because of the concern and need of consumers and farmers to develop a better understanding of agriculture and food in general, the American Farm Bureau Women's Committee has developed a plan for a "Farm-City Festival" and selected April 30, 1979 for a nationwide effort.

Every State Women's Committee and each of the 2800 County Farm Bureaus in the United States including Wayne County Farm Bureau women prefer to name this project "Agriculture Understanding Day".

We would like to take this opportunity to tell you, as consumers, that we farmers appreciate you. Plain as that.

You buy food and fiber grown on our farms and that is how we stay in business, for better or worse.

Your food bill is higher today than it was a year ago — as is the cost of everything you buy. This is the RESULT of inflation — not the CAUSE. Inflation, which is the number one problem of farmers and consumers, is caused by excessive government spending.

Farmers are asked to step up production. Provided the weather is good and we can get the necessary fuel and fertilizer, we will respond. It will help guarantee plenty of healthy kinds of products you want and need, and at the most reasonable prices possible.

We thought you would like to know farmers are working at the job. We will keep trying if you will keep buying.

WAYNE COUNTY FARM BUREAU

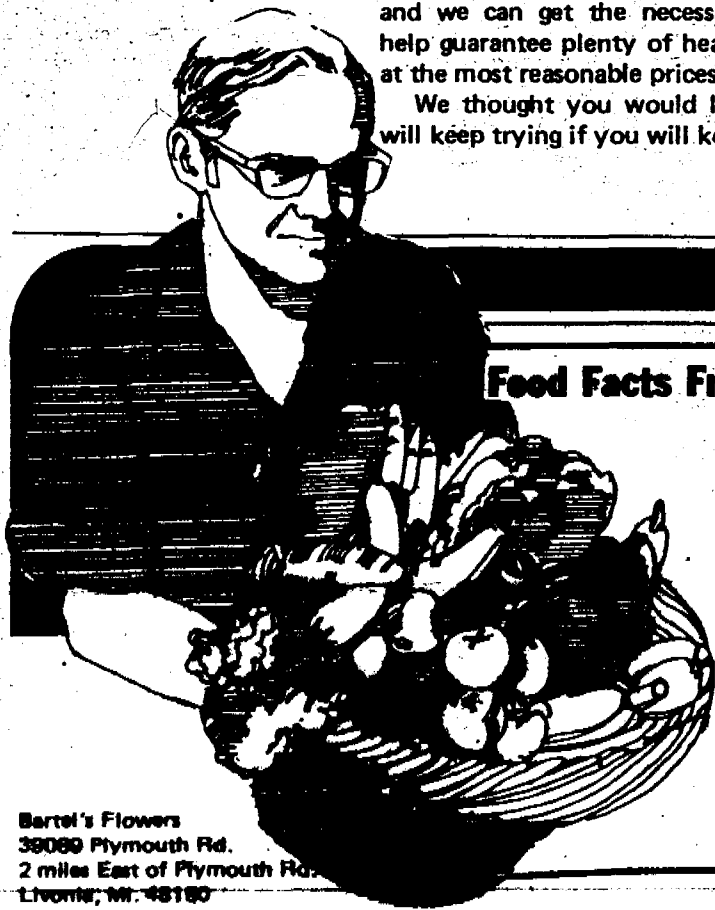
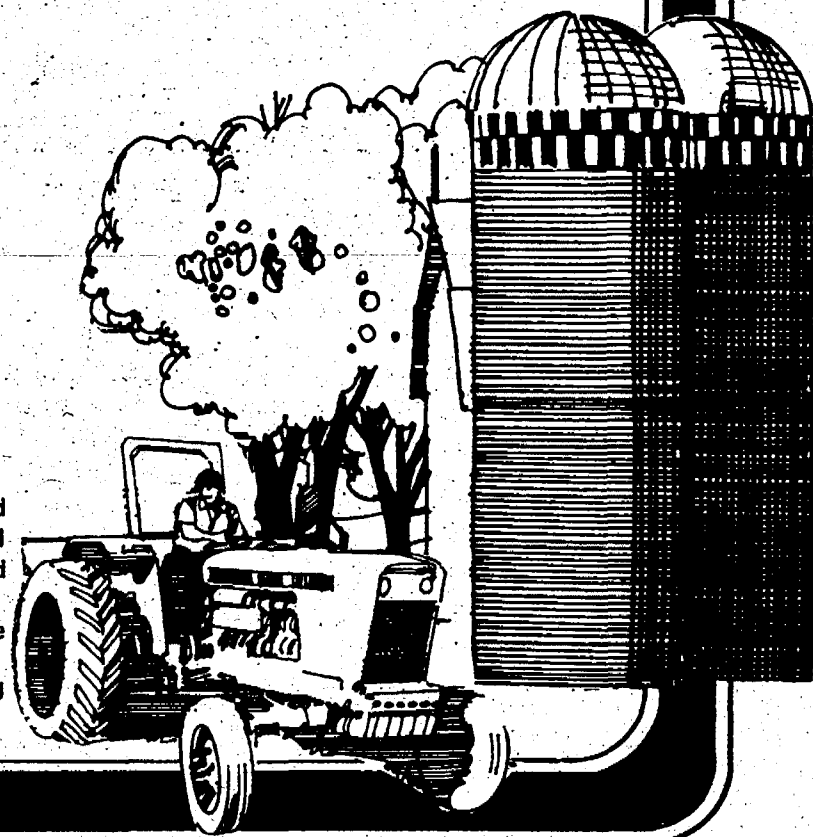

### Food Facts From Your County Farm Bureau

Did you know that Michigan manufactures about 34 million gallons of ice cream every year . . . enough for almost 30 double dip ice cream cones for every person in the state?

Did you know that Michigan is second in the nation in the production of rhubarb, one of the earliest crops to ripen in the spring?

Did you know that tomatoes are low in calories and a valuable source of vitamins A and C? These are food facts brought to you by the Wayne County Farm Bureau.

Graye's Greenhouse  
8820 Lilley  
Plymouth, Mi. 48170

Hauk Farms  
831 Ridge Road  
Canton, Mi. 48188  
Sweet corn, melons, field corn

Mettetal Greenhouse Inc.  
8425 N. Lilley  
Canton, Mi. 48187

Palmer's Bros. Farms  
48195 Warren Rd.  
Canton, Mi. 48188  
Soybeans, sweet corn, vege.

The Roadside  
43125 Joy Rd.  
1 block East of Main St.  
Plymouth, Mi. 48170 455-4111

Open 1st week of May.  
Large selection of quality bedding plants

Robson Petunialand Greenhouse & Sons  
9015 Haggerty  
Belleville, Mi.

Rochowiak Garden Fantasy  
10501 Haggerty  
Belleville, Mi.

Sayre's Red Barn Market  
43380 Ecorse Road  
Belleville, Mi.  
U-Pick vege. & strawberries

Robert Schultz  
48825 Proctor  
Canton, Mi.  
Sweet corn, soybeans, melons, field corn

Roy Schultz U-Pick  
7854 Lilley  
Canton, Mi. 48187  
Fresh vege. and strawberries

Schwartz Greenhouse Shoppe  
8201 N. Lilley  
Canton, Mi. 48187

Richard Sharland  
44617 Twyckingham  
Canton, Mi. 48187  
Turkeys, wheat, corn, soybeans

Clyde Smith & Sons Farm Market  
8000 Newburg Rd.  
Westland, Mi.

Sperr's Greenhouse & Flower Shop  
42510 Joy Rd.  
Plymouth, Mi. 48170

Tillotson's Greenhouses  
6355 Lilley Rd.  
Canton, 453-4321  
"Bedding & vegetable plants & hanging baskets"

Dennis and Amy Wilkin  
49060 Proctor  
Canton, Mi. 48188  
Wheat, corn, soybeans

Bartel's Flowers  
38089 Plymouth Rd.  
2 miles East of Plymouth Rd.  
Livonia, Mi. 48150

Blessed Strawberry Farm  
49801 Powell Rd.  
Plymouth, Mi. 48170 453-8439  
U-Pick strawberries & raspberries

Bunyan Farms  
50480 Powell  
Plymouth, Mi. 48170  
Pumpkins, corn, wheat, hay, soybeans

Fisher Bros. Greenhouse  
5228 S. Sheldon  
Canton, Mi. 48188 397-0083

Canton Power Equipment  
46600 Ford Rd.  
Canton, Mi. 48188  
John Deere Equipment  
Homelite chain saws, snowmobiles,  
Toro, Snapper

Coleman's Farm Market  
NE corner of Ridge and Holmes Roads  
Ypsilanti, Mi.  
Bedding Plants

Gill Bros. Farms  
1600 Ridge Road  
Canton, Mi. 48188  
400 dairy cows, crops

Good's Nursery  
81215 Ann Arbor Rd. at Napier Rd.  
Plymouth, Mi. 48170  
Complete Landscaping, trees, nursery  
stock, flowers, plants

Gottschalk Turkey Farm  
48175 N. Territorial  
Plymouth, Mi. 48170  
Fresh Dressed Turkeys

**FOR PATIOS—PORCHES—BOATS**

**Grass Carpet**

Indoors and outdoors

**\$4.95**  
sq. yd.

We will bring carpet samples into your home in many vibrant colors, if you find it difficult to visit our showroom. Call for an appointment today.

**Score II Rubber Back**

for kitchen, rec. room, utility room, steps.

**\$5.50** sq. yd.  
GOLD ONLY

**PLYMOUTH RUG CLEANERS**

1175 STARKWEATHER

453-7450



**Westland**  
**GARDEN CENTER**  
**and NURSERY**

**14 varieties of dwarf fruit trees \$12.95**

Large Selection of Evergreens, Flowering Shrubs, Ornamental and Shade Trees.

See our large selection of unusual specimen plants complete design and landscape service

32593 CHERRY HILL, WESTLAND, MICH. 48165

Ph 721-6610

Call now... If you want to enjoy

the first Spring Breeze

Right on your own Patio Deck or Porch

Waterproof (rot proof) References and photos of past workmanship & design. Constructed quickly & efficiently. Licensed.

20 years experience in building & design

**R. MONTRY CONSTRUCTION**

517-546-4375

313-453-6172

**Mister Spruce Says... 'DIG YOUR OWN & SAVE!'**

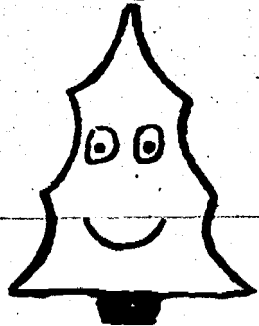

Austrian Pine (2-3Ft.)	\$4, 10/\$35
Norway Spruce	\$6
Colorado Blue Spruce	\$5 up
Red Barberry	\$2.50
Birch (7Ft.)	\$7
Pfitzer Juniper	\$4.50

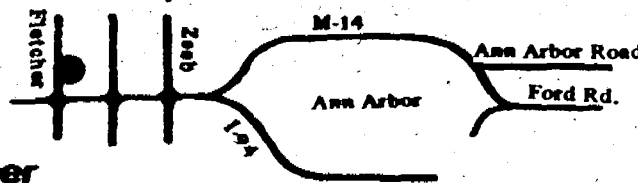

Bring Your Own Shovel and Container

**HEISE'S TREE FARM**

Northside I-94 at Fletcher Road—Exit 162 Chelsea

Saturday 9 to 5

Sunday 1:30 to 5

**Organic gardening means more than planting seeds**



LEE CAMERON

For Lee Cameron, home gardening is not just a way to grow extra food; it's part of her philosophy of life.

"I was sick of contributing to the chemical pollution of the planet. So I'm strictly an organic gardener," she says.

Organic gardening not only benefits the planet, but her garden as well, she says. "You learn not to just dump chemicals on your garden, but to work with nature, not against it."

The advantages of not putting chemical fertilizers, pesticides, and fungicides on the garden start with the fact that the plants get an even diet, says Lee.

"Giving your garden chemical fertilizers is like feeding it pep pills. You don't want an up-and-down cycle. It should be on a sound, steady diet that will give the plants a constancy."

How does she combat insects without pesticides? "Well, it depends on the insect. For slugs, I put a pan of stale beer out in the garden. They fall in and drown."

"For cabbage worms, you sprinkle water and rye flour on the eggs, which causes them to bake and die. And I hand-pick potato bugs and put them in kerosene. "I also plant a border of garlic, chives, and marigolds around the garden which by their smell keeps insects away. Another trick is to soak a bunch of garlic in water, and then use that to mist your garden. It smells like one big pizza, but it keeps the bugs away."

Crop rotation is another insect fighter, says Lee, who lives on Pacific Avenue in Plymouth. "Insects live in cycles. So if you break the cycle by not planting the same plant in the same place each year, they don't get a chance to settle in. Other gardeners don't do this. They rely on chemicals. You have to be a friend of your garden."

"Also, without chemicals, I don't have to worry that squirrels, birds and other critters might be hurt. I know they'll be safe when they enter the yard."

For fertilizer, Lee uses "all the organic material I can get my hands on — twigs, leaves, trimmings, peat moss, compost and manure."

"One trick is to make a manure tea by soaking manure in cheesecloth and sprinkling the water over the garden once a week."

Lee's garden supplies her with about one-fourth to one-third of her food for a year, which is considerable considering she's a vegetarian. She raises corn, beans, soybeans, endive lettuce, spinach, chard, peppers, two kinds of tomatoes, eggplant, cucumber, squash, potatoes, and many others, all on a plot about 20 by 16 feet. "I always give some away, too," she added.

Is it a lot of work? Only about an hour every other day, with a full afternoon on the weekends, she said, not counting spring preparation and fall clean-up.

"Organic gardening is a statement on the planet, how you see other people and taking care of what the Lord gave us," she said.



# Farmers with mikes to educate city slickers

Michigan farmers will "cultivate" the airwaves this spring when WJR radio in Detroit and the Michigan Farm Bureau kick off a year long publicity project designed to tell city people about farming.

The project involves popular WJR radio personality J. P. McCarthy, farm editor Scott Killgore, and Michigan Farm Bureau members from across the eastern half of the state. These designated farmers agreed to symbolically donate to WJR a portion of one of four different commodities — wheat, dry beans, hogs or apples.

McCarthy will put these farmers on the radio throughout the year and ask them about planting, tilling, fertilizing, marketing, taxation, regulations, inflation . . . all the various factors involved in the production of the commodity.

By hearing a live farmer talking on the radio about the rewards and frustrations of farming, consumers should gain a much better understanding of the agricultural process.

## Farmers invest \$650 billion in future's food

Are we investing enough in our future ability to eat? Look at it this way:

U.S. farmers have some \$650 billion invested in their agricultural enterprises, including buildings, land, machinery, livestock and other items.

During the past year, public fundings of food and fiber research in federal agencies and state agricultural experiment stations was about \$1.2 billion.

This means that public investment in our future ability to eat was less than two-tenths of one percent of what the farmer has invested in his present capability to produce what we eat.

Many private agribusinesses have continuing substantial investments in research and development in specific areas, such as new and more efficient types of farm machinery. But the need is cited for developmental research into broad-based subjects like photosynthesis, nitrogen fixation, climatology, food and nutrition and integrated pest management.

Research will have an important bearing on the future flow of food and fiber from field to family and is of vital interest to both.

# We Won't Lure You In With Fancy

## Talk Or Promises

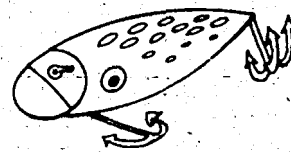

**Our Reputation For Quality Rustproofing  
Says It All!**

We have been attracting our customers with fine workmanship and the best five year replace or repair limited warranty in the industry.

**The best sealants — The best warranty — The best rustproofers.**

**Call your POLY-OLEUM Dealer today!**

**453-5859**

**\$10 Off with this ad**

Good thru June 1st.

**606 S. Main** (Corner of Wing)

**Your Car Will Last Longer-Be Worth More...**

With

**POLY-GARD™**

# Take out the Burger Family and a famous friend



FAMILY RESTAURANT

**It's a good thing to do**

**208 W. Ann Arbor Rd.**

**453-4886**

Where our food's as good as our Root Beer

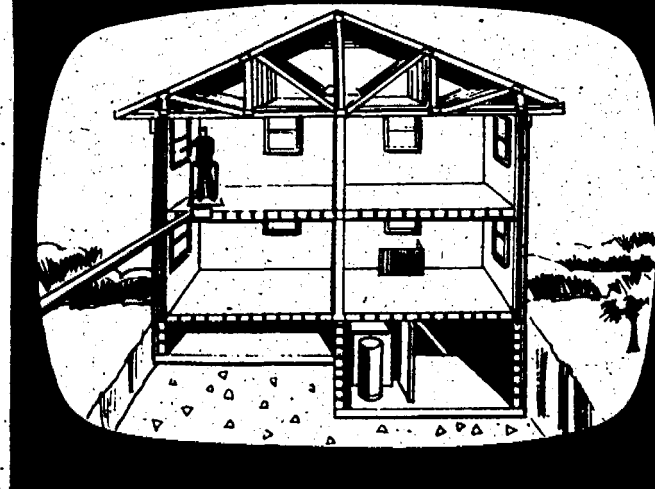

**If your home is under-insulated,  
you're paying too much for  
heating and cooling.**

If your home is more than 4 years old, it's probably not insulated well enough to protect you against today's high fuel costs.

We can tell you if your home measures up to Owens-Corning's new Recommended Insulation Standards for energy efficient homes. Call us today for a free estimate.

Insulation is cheaper than oil

453-0250



FIBERGLAS

**Air-Tite, Inc.**

882 Holbrook St.  
Plymouth, MI 48170

All types of home & commercial insulation  
An independent Owens-Corning Contractor

# Bolens<sup>®</sup> Lawn and Garden Equipment

**SAXTONS GARDEN center inc.**

Our 51st Year 1928-1979

587 W. ANN ARBOR TR. 453-6250

**SUPER SALE!**

**ORTHO**  
LAWN FOOD

**ORTHO**  
LAWN FOOD

**ORTHO LAWN FOOD**  
BUILDS GREEN HEALTHY TURF!  
FORMULA USED BY TURF EXPERTS

**\$4.99** 5,000 sq. ft. size  
**\$9.99** 10,000 sq. ft. size

**CRABGRASS KILLER**

**\$15.89** 5,000 SQ. FT. SIZE

**\*OPEN HOUSE APRIL 27 & 28\***

Tom Green, an Ortho Representative, will be on hand during our open house to help with any lawn and garden problems.



**REG. \$29.95**

Has a 1/2 hp. fertilizer applicator  
Designed to provide accurate application, even dispersion of fertilizer granules or pellets  
Lightweight, durable



**\$24.95**

Lightweight  
Throttle  
Push start  
4 yr. guarantee

**DANDELIONS?**



**ORTHO WEED-B-GON**



**ORTHO WEED-B-GON**

**ORTHO CRABGRASS KILLER**

## OPEN HOUSE SPECIALS April 27 & 28

### 18" Mulching Mower

1978 Model REG. \$174.95

**NOW \$759.95**

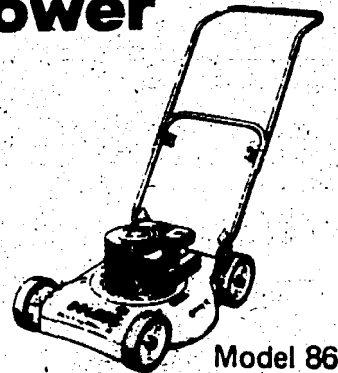

Model 8618

1979 Model

**NOW \$769.95**

REG. \$190.00

### 20" Mulching Mower

1979 Model REG. \$210.00

**NOW \$799.95**

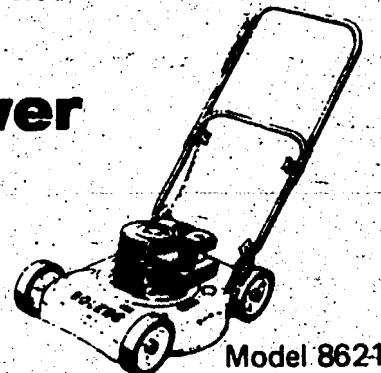

Model 8624

Self-Propelled

### 22" Mulching Mower

1979 Model REG. \$315.00

**NOW \$269.95**



Model 8644

Self-Propelled with Electric Start

### 22" Mulching Mower

1979 Model

**NOW \$339.95**

REG. \$370.00

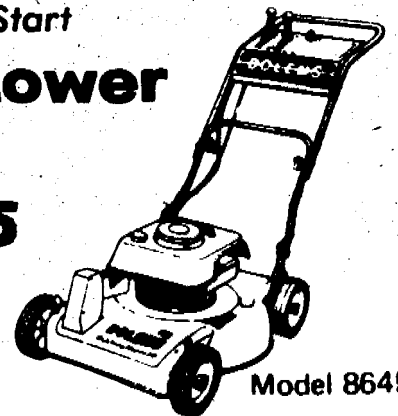

Model 8645

Everything for the garden but the rain

BUY WITH CONFIDENCE FROM A FULL SERVICE DEALER

# SAXTONS GARDEN center inc.

587 W ANN ARBOR TRAIL  
PLYMOUTH • 453-6250

DAILY 9 TO 6  
FRI. 9 TO 8  
SAT. 9 TO 5  
SUN. 10 TO 2

# All These Savings Accounts Available at Standard Federal Savings

Annual Interest Rate	Minimum Balance	Term	Effective Annual Yield
<b>8%</b>	\$1,000	96-Month Certificate*	<b>8.24%</b> <small>COMPOUNDED QUARTERLY</small>
<b>7<sup>3</sup>/<sub>4</sub>%</b>	\$1,000	72-Month Certificate*	<b>7.98%</b> <small>COMPOUNDED QUARTERLY</small>
<b>7<sup>1</sup>/<sub>2</sub>%</b>	\$1,000	48-Month Certificate*	<b>7.71%</b> <small>COMPOUNDED QUARTERLY</small>
<b>6<sup>3</sup>/<sub>4</sub>%</b>	\$1,000	30-Month Certificate*	<b>6.92%</b> <small>COMPOUNDED QUARTERLY</small>
<b>6<sup>1</sup>/<sub>2</sub>%</b>	\$1,000	12-Month Certificate*	<b>6.66%</b> <small>COMPOUNDED QUARTERLY</small>
<b>5<sup>1</sup>/<sub>4</sub>%</b>	No Minimum	Deposit or Withdraw at any time	<b>5.35%</b> <small>COMPOUNDED QUARTERLY</small>
Money Market Certificate*	\$10,000	Call 459-8666 to obtain the current interest rate.	

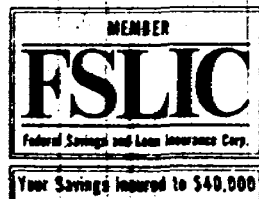

\*Federal regulations require a substantial interest penalty for early withdrawal from certificate accounts.

Or deposit \$5,000 or more into a new or existing account and receive one of these beautiful Oneida silverplate gifts.



All these gifts available when you open a new account at the Plymouth Township office or add to an existing Plymouth Township branch account. Federal regulations restrict the number of gifts to one per account, and no individual may receive more than one gift. No gifts are allowed for funds transferred from one Standard Federal Savings account to another. Gifts cannot be mailed. This offer good for a limited time only.

40909 Ann Arbor Road  
near Haggerty Road  
Plymouth Township, Michigan 48170  
Phone: 459-8666

Ronald J. Newth,  
Branch Manager

Branch Office Hours  
Monday through Thursday  
9:30 A.M. to 5:00 P.M.  
Fridays 9:30 A.M. to 8:00 P.M.

**SF**  
**STANDARD**  
**FEDERAL SAVINGS**

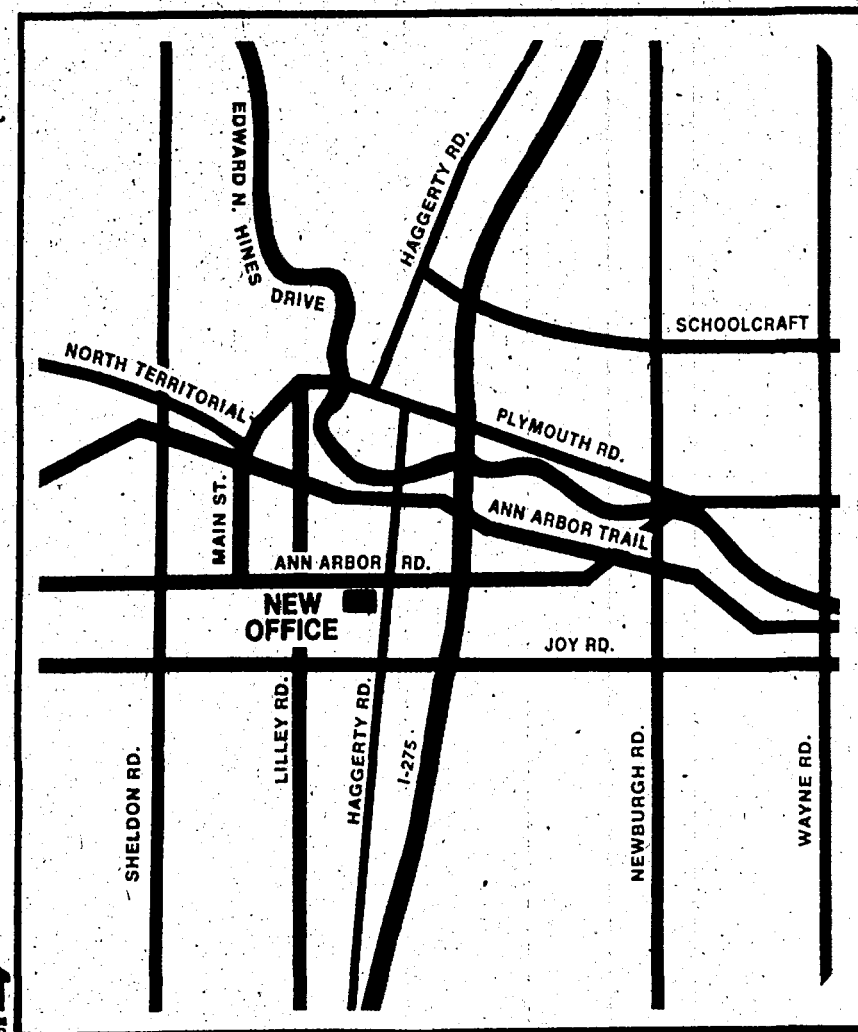



# Balmy skies lure walkers to Old Village Sunday

THE COMMUNITY CRIER: April 25, 1979



THREE-YEAR OLD Angel Zirles posed as a flower girl



UP, UP, AND AWAY. Balloons created a colorful effect during the Spring Walk through Plymouth's Old Village on Sunday afternoon. Michelle Waun, on the left, and Carey Oppe greeted the strollers with free balloons at streetcorners.

Photos by  
Patricia Bartold



JEFF SEVUCK filled the balloons with helium and passed them out.



ARMS LADEN WITH PACKAGES. Judy Halvary sat down to rest during Sunday's Walk through Old Village. Gail Latter is seated on the left.

## Canton Police Chief MacGregor quits

Cont. from pg. 1

force, which by both MacGregor's and the board's judgment, is undermanned.

Trustees proceeded to ask him some questions about the hiring, including how many hours the part-timer would work, what kind of medical benefits would he have, and whether MacGregor needed board permission to hire the man in the first place.

MacGregor became quite upset, however, when Trustee Lynne Goldsmith asked why a program for expanding the Canton force, which she said was promised weeks earlier, had not been

presented before MacGregor's request for the part-timer.

"I would love to have a plan to hire more part-time officers, but what good is a plan when there just aren't very many certified officers (schooled and able to arrest) who live in Canton and are willing to work at an hourly wage few men could live on," MacGregor replied. "I'd be damn lucky to find four, much less one."

Earlier this year, the board turned down a request for 10 full-time officers from MacGregor, saying it was too expensive.

After the board dented MacGregor the 10 extra men, Trustees Gene Daley and Bob Greenstein met with MacGregor to work out possible alternative plans to boost manpower in the force. And one of these was hiring more part-timers and reserves.

"He had been assured tacitly by me and Gene that he could hire this man," said Greenstein.

"I'm sorry to see him go," said Clerk John Flodin. "But we were asking questions that were in the line of how this hiring would affect the current contract negotiations with the police officers

union."

After MacGregor left the meeting, the board passed a resolution to permit MacGregor to hire up to 10 part-time certified officers with the stipulation that they work no more than 40 hours so as not to take over-time hours from the regular officers.

Hired as Canton's chief in August of 1977, MacGregor had earlier threatened to resign in November, 1978, but was persuaded to return by the Canton administration.

At that time he also said his health was a factor in his decision.



## Canton cops seek former employe

Canton police are seeking the arrest of a 23-year-old township man in the theft of almost \$1,000 from Canton Gas and Oil Co., 345 Canton Center Road, on Thursday.

A warrant has been issued for the arrest of Ronald Good, 1259 Stacy in Canton, who allegedly stole \$951 in cash and \$36 worth of cigarettes during his afternoon shift at the station, said Det. Sgt. Larry Stewart of the Canton force.

## Scouts planning

Adult volunteers, senior scouts, and first-class scouts will be the honored guests at the annual Girl Scout recognition meeting sponsored by the Plymouth-Canton-Northville Area Association.

The meeting will be held at West Middle School on Wednesday, May 9 at 7 p.m. It will honor the Girl Scouts' service to the community.

For more information call Mary Lou Johnson at 455-6719.

## Apple Runners promote kindness

MEMBERS OF THE APPLE RUN GARDEN Club lugged 450 pounds of dog and cat food into the Kindness Center for stray animals on Friday. The shelter serves strays from the Canton area. The following members are pictured above with their assorted animal friends: Sylvie Cutreva, Anne King, Sharon Palise, Margo Whiting, Carlie McDonald, and Dr. Bill Gregg of the center. (Crier photo by Bill Bresler)



CARLIE MCDONALD of the Apple Run Garden Club paused to show her feline friend an off-the-shoulder view of the world after the club members donated various items to the Kindness Center Animal Shelter on Friday. (Crier photo by Bill Bresler)

## Oils, glasswork art auction to benefit library fund

Tickets are going fast for the art auction to benefit the Canton Library Campaign Committee scheduled for April 28 at Township Hall.

On the block to the highest bidder will be a complete selection of original works, including oil paintings, lithographs, glass art, wood block, etchings and more, created by local and international artists. All works will be matted and framed.

Proceeds from the event will support the campaign to pass the one-mill levy to purchase a library for the township. The special election will be held May 9.

Refreshments and the preview begins at 7 p.m. on the third floor of Township Hall, which is the planned site of the library, and the auction begins at 8 p.m.

To buy a \$2 ticket to the event, please call 981-2224. They will also be available at the door.

## WALLPAPER SALE!

15% OFF 3 rolls or more

25% OFF on Stock  
Wallpaper



MOTHER'S DAY  
GIFTWARE SALE!

April 26-May 12

10% OFF on Gift Items

PEASE PAINT & WALLPAPER co.

570 MAIN STREET

453-5100

DAILY Mon. - Fri. 9-9 Sat. 9-6

Serving  
**PLYMOUTH-CANTON**  
COMPLETE OFFSET  
PRINTING SERVICE  
featuring 300 412 CAMERA

Call  
453-6770

**Pilgrim Printer**

632 S. Main, Plymouth

**ANN'S**

764  
Starkweather  
459-5444  
In Old Village



**GETTING THE BACK LEG STRAIGHT.** Brian Reel bends over to adjust and straighten the back leg of Mack, his collie, before being judged on "stance". About 30 dogs and their masters attended the all-day show in Northville.



**AT CINDY'S COMMAND.** As an advanced graduate novice, Charlie, an Irish-wolfhound-English sheepdog, had to perform a variety of tasks while his owner, Cindy Head, stood aside.



**SHOWING OFF HIS SHOWMANSHIP** is Brian Reel and his collie, Mack. Both attended the dog show sponsored by the Plymouth 4-H Paw Prints on Saturday. Brian is a student at Hulsing Elementary School.

## *Perfect paw prints win praise for pups*



*Crier photos by Bill Bresler*



# City P&R ready with spring classes, activities

Spring is the time of the year that you can do more leisure activities. The City of Plymouth Department of Parks and Recreation is offering a wide variety of spring classes and events.

One of the most popular classes offered is Disco Dancing for teenagers and adults held on Monday evenings.

The martial arts may be what you are interested in and Thursday nights is when Judo and Karate classes are offered to children from ages 8 to 17 years of age and also for adults.

For after school fun for the young, the Recreation Department offers an

Arts & Crafts Class on Monday afternoons from ages 4 through 12.

Ballet classes are offered for preschoolers from ages 3½ to 6 and beginners from 6 to 13. Tap classes are offered for ages 5 through adult. Jazz Exercise classes are offered for adults on Wednesday night for 11 weeks. Disco Jazz classes for ages 7 to 12 are offered on Thursday evenings.

Relax with Yoga in either a morning or evening class, which runs for eight weeks for beginners and advanced, held on Mondays and Wednesdays.

This is the time of the year to head

for the links, and whether you're new to the game of golf or want to brush up on your skills you can take a class on Mondays. Morning and early evening classes are offered for adults and afternoon classes for school age children.

Bread Dough Art will be taught on Wednesday evenings for six weeks at the Cultural Center.

You may sign up for any class by stopping in the recreation office located in the Cultural Center during regular business hours, or mail your registration to the Cultural Center, 525 Farmer Street, Plymouth, Mi. Checks must be made out to City of Plymouth. For further information call the Recreation Office at 455-6620.

A new Shuffleboard Club will be forming on Monday, May 7. The organizational meeting will take place at 7:30 p.m. in the Cultural Center. This club is open to all ages.

The Chess Club meets every Tuesday evening and everyone from Novice to Expert is invited to join the fun at the Cultural Center.

The Duplicate Bridge Club meets

at the Cultural Center on Tuesday evenings and Wednesday mornings.

The Party Bridge Group meets on Thursday afternoon at the Cultural Center.

On the second Monday of each month the Rock and Mineral Club meets at the Cultural Center from 7:30 - 9 p.m.

The Paint for Fun group meets every Thursday afternoon at the Cultural Center.

Now is the time to plan for the Community Garage Sale and the Police Bike Auction which will be held on June 22 and 23 in the ice arena area at the Cultural Center. Booth space is available at \$4 per day plus \$3.75 for table rental per day. Applications are available in the office.

Open skating is going on seven days a week. Ice rental is also available at the spring rental rate. Drop-In Hockey is on Sundays from 5 to 7 p.m. The cost is \$3 per person. You can still have an "Ice Time" at the Cultural Center.

For further information on any leisure time activities, call the Department of Parks and Recreation at 455-6620.

## Public invited

# CEP plans 'Law Week'

Parents, students, and faculty are invited to participate in Law Week Activities from April 30 through May 3 at Canton High School.

Some highlights of the four-day program include: a panel discussion on alternatives to prisons with an ex-convict among the participants; a talk on "Decriminalization of Marijuana"; a dis-

cussion on How to Avoid Rape; a talk by Maurice Breen, Plymouth Township trustee, on "The Law and Alcohol,"; and, a talk by Robert Greenstein, Canton Township trustee, on "The Crisis of the Uncontrolled Population Explosion."

Also, the movies, "Inherit the Wind" and "Twelve Angry Men," will be shown.

## community deaths

### Rapson

Ruby (Robena) Rapson, 67, of Canton, died on April 19 at Providence Hospital in Southfield. Funeral services were held on Saturday April 21 at Schrader Funeral Home with The Rev. Darryl Bell officiating.

She is survived by her husband, Howard; daughters, Ruby Stern of Canton, Selma Evans of Canton; sons, Malvin Rapson of Canton and Richard Rapson of Detroit; sisters, Margaret Pickles of London, Ontario, Canada, Dorothy Norman of London, Ontario, Canada; brother, Harry Pickles of Belmont, Ontario, Canada; 14 grandchildren; and, six great-grandchildren.

Mrs. Rapson came to Canton two years ago from Houghton Lake. She worked as a clerk in retail sales.

### Hoover

Leslie Anne Hoover, the three-and one-half year old daughter of Mr. and Mrs. William C. Hoover of Canton, died on April 21 at Mott's Children's Hospital in Ann Arbor. Funeral services were held on Tuesday, April 24 at the U.S. Naval Academy Chapel in Annapolis, Maryland. Burial was at Hillcrest Memorial Park in Annapolis.

She is survived by her parents, William and Janice Hoover; brother, Brian W., at home; grandparents, Mr. and Mrs. John R. Hoover of Cherry Hill, N.J. and Mr. and Mrs. William C. Nassan, of Pittsburgh, Penn.

Funeral arrangements were made by Schrader Funeral Home.

### Lockwood

Willard Emil (Sunshine) Lockwood, 69, formerly of Plymouth, died on April 16 in Livonia. Funeral services were held on April 19 at Schrader Funeral Home with Pastor Leonard J. Koeninger officiating. Burial was at South Lyon Cemetery.

He is survived by his wife, Anna; daughters, Patsy Goupie of Westland, Susan Wess of Westland; son, Willard E. Lockwood, II of South Lyon; sisters, Pauline Cox of Virginia, Marion Wudyka of Livonia; brothers, Russell of Belleville, David of California, James of Arizona, Albert of Texas, Frederick of South Carolina; and, nine grandchildren.

Mr. Lockwood was the owner of a greenhouse and produce stand on Ann Arbor Trail in Livonia for 40-45 years. He also delivered fresh fruits and vegetables to many restaurants in Plymouth for years.

He was a member of St. Peter's Evangelical Lutheran Church in Plymouth. Memorial contributions can be made to the Michigan Heart Fund.

### Beavine

Alfred A. Beavine, 63, of Canton, died on April 12 at St. Petersburg, Fla. Funeral services were held on April 16 at Schrader Funeral Home with The Rev. Dale Gross officiating. Burial was at Cadillac Memorial Gardens, West.

He is survived by his wife, Elsie; sons, Alfred of Canton, Roger of Livonia, Raymond of Milford; daughters, Gloria Martin of Detroit, Darlene Culp of Detroit, Delora Gawlick of Livonia; and, 20 grandchildren.

Mr. Beavine was retired.

### Cumming

Louise Cumming, 86, of Plymouth, died on March 31 here. Funeral services were held on Wednesday, April 4 at Schrader Funeral Home with The Rev. Philip Rodgers Magee officiating. Burial was at Parkview Memorial Cemetery.

She is survived by two sons, John of Plymouth, Bruce of Plymouth; sisters, Margaret Jameison of Hamilton, Ontario, Canada, Agnes Garioch of Scotland; brothers, Donald, Bill, Harold, David Hepburn, all of Scotland; seven grandchildren; and, 11 great-grandchildren.

Mrs. Cumming was formerly of Detroit. She moved to Plymouth six years ago. She was a homemaker.

### Pedersen

Soren P. Pedersen, 91, of Plymouth, died on April 19 at University Convalescent Center in Livonia. Funeral services were held on April 23 at Schrader Funeral Home with The Rev. Earven Andersen officiating. Burial was at Glen Eden Cemetery in Livonia.

He is survived by his wife, Katrine Olesen; sons, Jens of Silva, N. Carolina, Niels of Plymouth; daughter, Stella Stevens of Clinton; seven grandchildren; and, 14 great-grandchildren.

Mr. Pedersen was a repair man and forger. He was a member of the Danish Lutheran Church and the oldest member of the Danish Brotherhood in Detroit.

### Farmer

Crystal Ann Farmer, the infant daughter of Mr. and Mrs. Ronnie Farmer, died on April 19 at St. Mary Hospital in Livonia. Funeral services were held on April 21 at Schrader Funeral Home with The Rev. Father Robert Keller officiating. Burial was at Riverside Cemetery.

She is survived by her parents, Ronnie and Ann Marie Farmer; grandparents, Mr. and Mrs. Francis Koenig of Peoria Heights, Ill. and Mr. and Mrs. Ambrus Farmer of Livonia; and, several aunts and uncles.

Crystal Ann was seven months old.

for 75 years . . .

A TRADITION

# SCHRADER

FUNERAL HOME, INC.

280 SOUTH MAIN STREET, PLYMOUTH 453-3333

Edwin A. Schrader, Jr.

Edwin A. Schrader

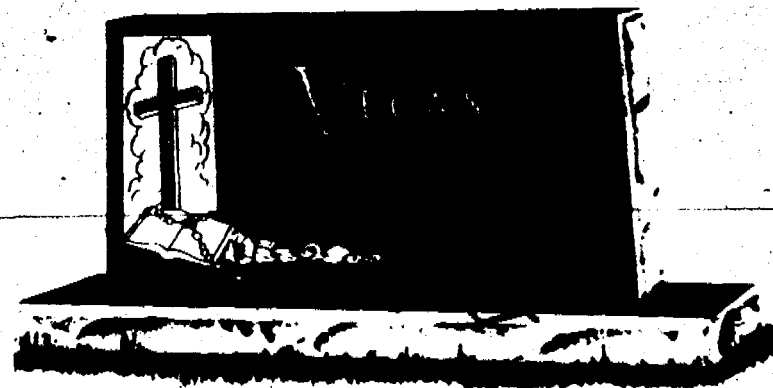

## Allen Monuments

580 S. Main St. Northville, Mi. 48167

349-0770

Granite, Marble and Bronze - Michigan's Largest Selection

# sports

## Owens K's 10 in 2-hit victory over Allen Park, 7-0

BY E. DALE LEE

Salem High ace pitcher Barry Owens allowed two hits and struck out 10 last night in blanking Allen Park at home, 7-0.

The Rock senior moundsman went the full seven innings, allowing a walk with no strikeouts.

"Barry had less than 80 pitches today," Salem manager Brian Gilles said of the righthander. "He was ready to go."

Allen Park used its ace, Jimmy Lada. But he gave up five runs, two earned, in five innings of work. Fireballer Scott Vaughn gave up two runs in one inning of relief.

The victory wasn't an overpowering one for Salem — they only had eight hits. What aided the Rocks' cause tremendously was the comedy of errors — five in all — that the Allen Park fielders botched.

The Rocks jumped into an early lead. Rightfielder Paul Woodard, who went 3-for-4 on the game with three runs scored and a run batted in, opened the first-inning with a double to the leftfield fence. Sam Merrill grounded out to first and Woodard advanced to third. Woodard scored when Jim Anderson bunted him home.

The Rocks added their second run in the second inning. After Mike Woodard bounced out to the first-baseman, Paul Dillon walked. Mike Cimino then singled to left and Dillon scampered home with the second run.

Salem pushed three more runs across in the fifth inning. Owens fanned to start the frame before Paul Woodard reached base on a bunt single; Merrill bashed a base-hit to right, moving Woodard to third. Merrill then stole second base, but the ball was overthrown and Woodard crossed the plate.

Anderson drilled a single after that to score Merrill. The Rock first-baseman advanced to second on a wild pitch by Lada. Anderson then stole third and scored on another wild pitch.

Vaughn took the hill for the Jaguars in the sixth inning and promptly gave up two unearned runs. Two painful runs for Rock batsmen.

Dillon was hit by a pitch leading off the inning. He moved to second when Vaughn's pick-off throw at first sailed away. Cimino was hit by a Vaughn offering on the next pitch.

Dillon and Cimino pulled off a double steal and Chuck Janovsky struck out. Dillon was gunned down at the plate by the Allen Park first sacker on the strikeout because the catcher had dropped the ball and had to throw to first.

Paul Woodard then found the hole in Allen Park's defense, lining the ball into the shortstop hole to left for a single, scoring Cimino. Woodard alertly went to second when the leftfielder overthrew the cutoff man.

Then Anderson walked. Woodard streaked for third when the Jaguar

catcher fumbled the ball and scored when the third baseman's throw to second (trying to nail Anderson's advancement) went into right field for the seventh run.

"When you get defense your defense

comes alive," Gilles explained. "We hit the cutoff man real nice today."

The Rocks play Northville and Ypsilanti at home in a twin bill Thursday. Game time is 1:30 p.m.

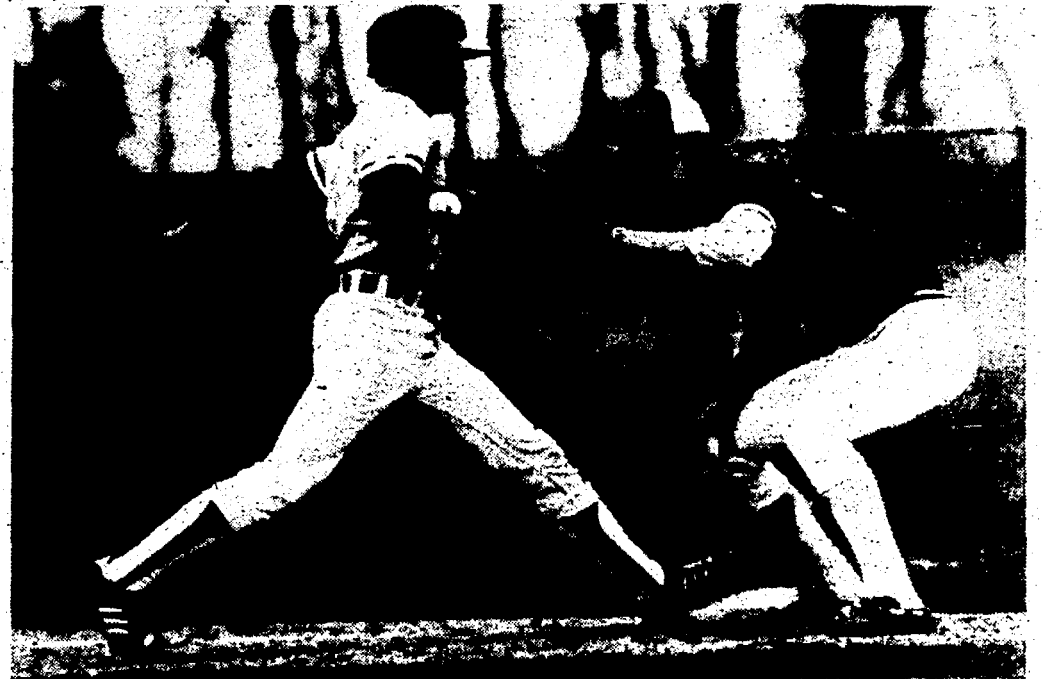

ROCK PAUL WOODARD rushes to first base for a close call. Salem High defeated Allen Park yesterday by a 7-0 final. (Crier photo by Bill Bresler).

## Rock netters go 3-0 with 6-1 Jaguar triumph

The Salem High boys' tennis team upped its record to 3-0 in the Suburban Eight League yesterday with a 6-1 triumph over visiting Allen Park.

Rock first singles man Bob Braun dumped Jeff Wagner by 6-2, 6-1 scores; Ed Thomas breezed past the Jaguars' second singles performer, Joe Greene, 6-2, 6-0.

Salem's lone loss came to third singles man Dick Cook, who fell in three sets (6-3, 1-6, and 3-6) to Allen Park's Paul Bisaro. Scott Crespo dumped Mike Emmanuel at fourth singles by 6-1, 6-3.

Other Salem winners yesterday included the first doubles team of Craig Stevens and Mark Thomas; the second doubles team of Bob Jarvis and Craig

Baker; and third doubles performers Doug Baker and Blake Lundsberg.

Monday the Rocks downed Livonia Bentley by a 5-2 tally.

Braun dropped his match at first singles to Pete Payroian by 3-6, 7-5, and Cook lost at third singles to Chuck Croci, 3-6, 6-7.

Ed Thomas garnered a three-set victory from Bill Evasic at second singles and Scott Crespo outlasted his opponent, Bruce Klimek, by 6-3, 6-3 finals.

Stevens and Mark Thomas, Craig Baker and Jarvis, and Doug Baker and Lundberg swept first through third doubles for the Rocks.

The next scheduled match for Salem is Thursday against Livonia Stevenson at home. Court time is 3:30 p.m.

## PCJBL humbles attorney

BY E. DALE LEE

Three divisions of the Plymouth-Canton Junior Baseball League — A, B, and G junior league — held tryouts Saturday morning without incident.

Three men and an attorney came to the league's monthly meeting April 11 in a last ditch effort to transfer a player from one team to another in the "A" League.

The Executive and Primary Boards of the circuit met last week and have decided to make the boy stay on the team he's currently on in conjunction with the league's by-laws.

"The Boards and I met last week and decided that we weren't going to bend

the rules in this case," said President Jim Schols. "It would be wrong of us to do so."

"The attorney at the meeting mentioned that what they were trying to do was done about five years ago. If that indeed happened, the rules were violated — not amended."

Schols says the men have accepted the Boards' decision and will not take the matter through the legal system. Schols added that tryouts for the "E" and "F" leagues have been postponed from April 28 to May 12. "E" League boys will tryout at 9 a.m. and "F" League boys at 1 p.m. at Central Middle School.

*Something to Share with Someone*

# IT'S FUN!

TO EAT AND DRINK at.....

**Little Caesars Family Inn**  
PLYMOUTH

1492 SHELDON RD. at Ann Arbor Rd.

---

INTRODUCTORY OFFER

## \$1.00 OFF

The Regular Price of Our

## BOUNTIFUL BUFFET

### ALL YOU CAN EAT

A Tasty Selection of Italian Dishes  
Reg. \$4.99 only \$3.99 with this coupon

Little Caesar's - Plymouth Expires 5/4/79

---

## \$2.00 OFF

ANY LARGE PIZZA  
DINE-IN OR CARRY OUT

453-1000

Little Caesar's - Plymouth Expires April 30, 1979

## FREE

See Your  
T.V.  
Magazine  
for Free  
Coupon

# Balconi's gang mugs Livonia Bentley, 86-46

BY E. DALE LEE

"We ran as good a mile relay as I've seen in years," said Salem High track Coach Gary Balconi following last night's 86-46 make-up victory over Livonia Bentley in the Rocks' Suburban Eight League opening meet.

Bentley swept the 440-yard dash before the Salem mile-relay team of Leigh Langkabel, Jack Wellman, Dave Truesdel, and Dennis Ogden copped a first with a 3:36.4 timing.

"It was beautiful," Balconi beamed. "Oggie ran shoulder to shoulder with

Bentley's anchor and finally got him at the end."

Ogden also won the pole vault with a 14 feet, six inch clearance. Wellman grabbed second place with a 12 feet, six inch jump.

Senior Rich Hanschu grabbed a first in the 120-yard high hurdles with a :15.7 effort. He also took a first in the long jump (20 feet, eight inches), the 220-yard run (:23.4), and ran anchor on the first-place 440-yard relay team with Greg Lipka, Craig Stack, and Greg Stevens (:45.7).

Senior Rob Neu won the high jump

with a five foot, 10 inch effort. Neu also placed third in the long jump (18 feet, 10 inches).

Stack (:10.8), Stevens (:11.0), and Lipka (:11.0) swept the 100-yard dash, as did Jeff Haertel (4:42.8), Paul Hess (4:45.0), and Dave Rubadue (4:56.9) in the mile-run.

Hess (10:31) and Haertel (10:34) finished one-two in the two-mile, as

did Kevin Waara (2:05.4) and Truesdel (2:06.1) in the 880-yard run.

Stevens finished second in the long jump. Freshman Scott Fuller finished second in the high jump while John Froozan recorded runner-up finishes in the discus and shot put.

The next scheduled meet for the Rocks is Thursday at Belleville High at 4 p.m.

## Late push saves Salem

BY PATRICIA BARTOLD

The Salem High girls' track team won the last event (the mile relay) of yesterday's home meet against Livonia Franklin to pull out a 63-60 victory. The Rocks trailed by a point going into that final race.

The team ran hard, completed smooth handoffs, and wanted to win, said Coach

### Chief runners tumble to 0-2; lose to Central, 68-54

BY PATTY RADZIK

The Canton High girls' track team dropped a 68-54 decision to Walled Lake Central last night, pushing its record for the young season to 0-2.

Kelly Heaton returned to action in the shot put for the Chiefs. She had been laid off because of an ankle operation. Heaton's toss was not up to par and Canton settled for a second-place finish in the event.

Jill Pederson captured the 220-yard low hurdles with a time of :35.0, and placing second in the 110 lows.

The team of Jerry Perrot and Geri Schufeldt ran to first and second places, respectively in both the one- and two-mile races. Perrot's victory times were 5:59 in the one-mile and 13:09.2 in the two.

Kathy Brophy came in second in the 440-yard dash with a :65.3 timing. Canton also won the 440-yard relay, clocking a :56.3 time.

In the 880-yard run, the Chiefs actually captured the winning spot, but a late hand-off of the baton disqualified the effort.

Other final events included a first-place run by Sue Coll in the 220-yard dash, a (2:41.9) second-place finish by Julie Fideler in the 880, and a second-place leap by Michele Bigelow in the high jump.

Canton will try for its first victory of the season Thursday, when they take on Livonia Churchill at home at 3:30 p.m.

Scott Kurtz after the meet. The relay team was made up of Linda Lybarger, Diane Perpich, Ruth Langkabel and Rochelle Baltés. The winning time was 4:37.9.

First places were awarded to Ann Meixner in the following races: 220-yard dash (:29.5); 220-yard low hurdles (:32.5); and the long jump (15 feet, two inches). She also captured a second in the 110-yard low hurdles (:16.9).

Ruth Sample ran to a first-place in the mile run with a 5:47 timing.

Lori Grissom took third-place in the event with a 6:09 finish. Sample also won the two-mile race in 12:50, her best time of the season.

Baltés knocked five seconds off her previous best time in the 880-yard run. Her time was 2:34.

Lucas soared 14 feet, seven inches in the long jump for a third-place finish and then tied with Perpich for second-place in the high jump at four feet, eight inches.

Lybarger ran to a first in the 440-yard dash, while in the 220-yard low hurdles, Erin Lucas took second place with a :33.3 time. Renee Slavin took a third in :35.0.

The next scheduled dual meet is Tuesday, May 1, at Walled Lake Western. Saturday the Rocks will compete in a late addition to their schedule, an invitational meet.

## Salem prepping for Canton golfers

The Salem High girls' golf team opened its season with a victory over Brighton High yesterday afternoon, 220-226.

Here's a rundown on the Rock score-sheet: Ruth Maggio - 50 points; Carol Ross - 54 points; and, Nancy Stevens and Meg McGee - 58 points each.

Kathy Regan of Brighton was the medalist of the meet. She completed nine holes in 48 points for the lowest total. The match was played at Faulkwood Shores in Brighton.

Thursday afternoon Salem will play a match against Canton High at the Hilltop Golf Course in Plymouth Township at 2 p.m.

## Stevenson whitewashes Canton

Canton High opened its 1979 boys' tennis season Monday on a sour note, falling 7-0 to area power Livonia Stevenson.

Bob Young dropped a 2-6, 2-6 decision to Jim Pfeffer at first singles and Dan Schmidt fell to Rod Carpenter at second singles, 1-6, 1-6.

Thad Louviere dropped an 0-6, 1-6 match at third singles to Glen Gwarda, and Peter Lee stretched his encounter with Frank Piana to three sets (6-7, 6-4, 3-6) before losing.

Curt Crocker and Mark Roberts suffered a 3-6, 1-6 defeat to Ken Hunt and Larry Schoff at first doubles; Keith Logsdon and Steve Jones were easily downed by the Spartan second doubles pair of Doug Holmes and Joe Schram, 0-6, 1-6; and Kreg Kinnel and Bob Adams were handed a 1-6, 4-6 setback competing against Chuck Fedraw and Dave Stranquist.

The Chiefs tangle with Livonia Churchill today (away) at 4 p.m.



## Have Suit . . . Will Travel

and travel in style with this Swedish woven three-piece suit that stays crisp like a knit yet wears like a worsted for year around comfort.

In stock or readily available in sizes 36 to 56

Regular-Short-Long-Extra Long

Grey, Blue, Brown, Green

Custom fitted in our own tailoring shop

**\$165-\$185**

We urge you to compare our suit prices

**Lapham's**  
Men's Shop

Open Thursday & Friday 'til 9 p.m.



# Boston Marathoner Gene Kramer tells his story

BY GENE KRAMER

I'm almost recovered after running "The Boston." But as the body mends, the mind fights off depression. This is only natural, I'm told, as a great event subsides. If the let-down is in proportion to the build up, I'm headed for doom! I have truly experienced one of the greatest events of my life.

As a result of Mr. Lee's story in the April 11 Crier, I received a tremendous send-off. By noon on Saturday, April 14, at Metro Airport, I was about as psyched up as one could get. I had been handshook, patted, hugged, saluted, and interrogated by hoards of the curious and concerned. Several students even wanted my picture autographed, and it was great having the attention. But I began to wonder if I could live up to their high hopes for me.

One does not approach a 26 mile, 385 yard race with mere high hopes and reckless abandon. I vowed to stay calm and moderate in all the excitement to follow. Like many a New Year's resolution, this one didn't last.

The very idea of me, a teacher, going to Boston — with all of its heritage — precluded my attempts to concentrate on racing. The old streets, buildings, burial grounds, and churches had my attention long before the plane took off. I absorbed maps, books and brochures, and quizzed many others who had been there. Of course, I had also gathered a wealth of materials about marathoning, but my teacher's mind had been starved for too long — I had to seek our "roots!"

I borrowed a camera and even lugged along a tape recorder in a desperate attempt to "get it all" in a day and a half.

Marathoning requires a singleness of purpose. Even in beginning training

some three months in advance, a constant effort is made to stay on schedule. Running, sleeping, working and eating are all carefully coordinated. Yet, in my boyish (age: 41) excitement, I couldn't relax in Boston.

Even worse, I underslept, overate, and became exhausted on the tour. The subway rides were quite beyond my expectations.

I was in great company, though, especially at Ye Olde Union Oyster House (established in 1826), where I joined Bob McOmber and Erma Tranter, winners of the Detroit International Marathon last October. Also along was Dr. Ed Kozloff and his family with the Detroit Striders. Ed was interviewed by two members of a Detroit daily newspaper.

It was very inspiring to meet such people, especially since I had merely been invited on the Striders' trip, even though I'm not a member of the club.

Easter Sunday should have been restful, but in fact it became quite tiring before we finally retired after midnight. It started with a nice three-mile run to help my 52-year-old Italian roommate, Giulio Paniccia, test out his ailing hip. (This seemed fine, but he was really troubled in the race. Still, he gutted it out for a respectable three hours and 26 minutes).

Sunday at noon found us wandering and waiting around the huge Prudential Center complex with thousands of others, trying to obtain our numbers (mine was V349) and a bus ticket for the ride to Hopkinton. Hopkinton is a western suburban village about the size of Northville, where the race would begin.

By Sunday afternoon the weather had become cold and rainy, and this

continued through most of Monday. My struggles with camera and recorder along "The Freedom Trail" will always be recalled with a bit of humor, as I was soon maneuvered by the elements and my less inspired friends from the grave of Paul Revere into a cozy cafe. There we indulged in some Yankee Pot Roast and spaghetti! (By the way, I didn't get a free spaghetti dinner. They wanted \$6 for it at the Sheraton Boston Hotel, so many of us declined. However, we did receive a free cup of Irish stew in the "disaster area" after the race. It was great — perhaps even life-saving at that point!).

Our hotel's whirlpool bath was a fine place for relaxing, but somehow Giulio inticed me and some others to seek out a nearby restaurant for some Italian soup. We got lost! And after much walking and a few bum steers, we settled into a bar and grill, where we ate stuffed green-pepper sandwiches. This would be a tough race!

This whole story sounds as though I was not in my best racing form. And that's simply true. But in spite of all this, I felt fine as we arrived at Hopkinton Monday morning.

As we awaited the noon start, I saw and met runners from all over the world. They were of all ages and levels of experience. Most were glad it was cool rather than hot, but I think the 40 degree drizzle eventually changed many opinions as fatigue came early with such exposure. Several busloads, I'm told, were driven to hospitals or to the finish.

The start was very jubilant, with about 8,000 qualified runners and a few thousand extras. About 20 wheelchair racers were allowed to leave 15 minutes early. Then followed (eventual winner) Bill Rodgers and the fleet ones at the front. The rest of us were ranked according to our previous records. That placed me about two-thirds to the rear of the pack, having run three hours and 18 minutes in the Detroit International.

It took me about four minutes to cross the starting line, and it seemed too crowded to pass anyone for about three miles. But in spite of this, and a tough hill at the outset, I managed to cover half the race by an hour and a half. This was in keeping with my highest hopes of finishing near three hours — but troubles set in.

Perhaps because I did run mainly on the right side of a crowned road, my left leg began to cramp. I switched sides, but soon both legs were severely aching. The wonderful town, roaring spectators, and warm welcome of the Wellsley girls could do little to relieve the pain of fatigue that was taking its toll.

Four more hills, including "Heart-break Hill," had a big part in making this course respected throughout the world — and in sapping the main portion of my strength. With some five miles to go, I found myself slowing down. My experience told me to trudge on, but my body said "no!, take it easy, have a drink, and walk a bit." So I did, many times!

The crowd was trying to help. In those last few miles, I was handed all manner of drinks and food, including dates, oranges, pineapple, melon, and raisins. I stood in a daze for a moment — I suppose I was hitting "the wall."

I must have walked half a block at a time, with the well-meaning crowd telling me to "hang in there — only two miles to go!" This phrase was repeated for about three miles, it seemed, until I finally saw a sign stating 2.3 miles to the finish line. I lost faith in the people then, and walked even more, ignoring their shouts. I even suspected a hoax when they said there were only three



Gene Kramer is a 41-year-old teacher at Salem High who ran in the Boston Marathon on April 16. Today, Kramer tells of his adventure in a Crier Guest Column.

blocks left. But as I turned a corner and saw the Prudential Center, I knew it was true. I came in with a kick, noting the digital clock at the finish line showed 3:41:37.

Looking back upon all that happened, I won!

## Gilles gals dominate net tourney

A pair of local netters grabbed national honors over the weekend.

12-year-old Chris Gilles and 11-year-old sister Wendy competed in the Louisville Tennis Club Junior Invitational with fantastic results for the two girls, whose father, Brian, coaches the Salem High baseball team.

Chris took the singles title in the 12-and-under division, winning a silver cup. She combined with No. 1 seed Chris Nagle to beat Wendy and her partner, Madeline Willard, in the doubles championship match.

"They work very hard," Brian Gilles said. "I am proud of their accomplishments. They're nationally ranked — not anybody could have entered this tournament."

## This is it for Pitch, Hit & Run registration

Pre-registration for Major League Baseball's Pitch, Hit & Run competition June 9 at Massey Field off Main Street in Plymouth must be made at the local Burger King restaurant on Ann Arbor Road before April 30.

Each youngster competes in three categories: pitching at a target, hitting for distance, and running the base paths for speed.

In pitching, each competitor is allowed three throws into a target 46 feet away. Each successful pitch is worth 50 points.

In hitting, each youngster gets three swings (fair or foul), with the longest fair fly counted towards the total point score at one point per foot.

In the running event, the entrant runs the Major League distance of 90 feet from home plate to first base with his or her score determined on a point chart based on time.

100% Naturally Flavored Ice Cream 453-4933

**FEATURE OF THE WEEK**

**SAVE 20¢**

ON A HALF GALLON OF **Butter Pecan Ice Cream**

Try this best seller for an old fashioned taste treat! With this coupon thru May 2nd PLYMOUTH STORE ONLY 447 FOREST AVE.

Our Ice Cream is made right here in Plymouth. It is the Best you can buy!

Open 365 days a year Drive up Window Service -but not on Fountain Items

**NAPA**

**WHILE OTHERS MAY GUESS ON CAR REPAIRS... THE PERSON BEHIND THE NAPA COUNTER KNOWS!**

**NEW!**

We now make High Pressure Hydraulic Hoses while you wait for Farm, Truck, Construction and Industrial Equipment & machines. Heavy Duty Factory type Crimp.

**B&F AUTO SUPPLY inc**

1100 Starkweather, Plymouth 453-7200 Mon-Fri 8-7; Sat 8-4; Sun 10-3

We have over 50 years experience

**we help keep America moving**

# Rocks bury Sterling Heights in drizzle, 13-3

BY E. DALE LEE

Salem High exploded for eight fourth-inning runs with the aid of four wild pitches at home Saturday in burying Sterling Heights Stevenson, 13-3.

"The field wasn't that bad," Rock manager Brian Gilles said, despite the drizzly elements. "A ground ball or two skipped through the grass, but nothing major."

Rock second baseman Paul Dillon opened the fourth with a single to left. Barry Owens struck out before designated hitter Chuck Janovsky moved Dillon to second with a single to center. Then the fun began.

Sterling Heights starting pitcher Jim Hugg balked, moving the runners to second and third. Hugg then uncorked a wild pitch, scoring Dillon. Janovsky moved to third.

Paul Woodard, who went 1-for-5 for the afternoon, flied out. Sam Merrill then slugged a two-run homer for a 4-3 advantage.

Jim Anderson kept the rally going with a base-hit. He moved to third on another Hugg wild pitch and an error by the second baseman, then scored on yet another wild toss.

Catcher Dave Wilcox, who went 4-for-5 for the day, then drilled a 365-foot solo home run over the left center-field fence for a 6-3 lead.

Matt Etienne walked and Mike Woodard singled to place runners on first and third. Etienne scored on another wild pitch and Woodard moved to second. Dillon drew a walk before another Hugg heave moved them to second and third. The pair scored on Owens' line single to left. Janovsky singled and Paul Woodard struck out to end the string, 9-3.

The Rocks pushed four more runs across in the fifth inning. Merrill led off with a walk. Wilcox singled him to second. Sterling Heights' new pitcher, Dave Mandrella wild pitched them to second and third. Etienne sliced a single to right, scoring the pair for an 11-3 edge.

Mandrella wild pitched Etienne to second before Mike Woodard walked. Dillon then flew out to centerfield before Mandrella balked, moving the runners to second and third. Owens drilled a single to center, scoring Etienne and Woodard. Janovsky walked before Paul Woodard ended the inning with a bouncer to second.

Salem scored its initial run in the second. Mike Woodard popped to the shortstop before Dillon walked. Owens reached first on a fielder's choice before Paul Woodard singled, scoring Owens. Sterling Heights opened the scoring

with a two-run blast in the first inning by first baseman Jim Meares off Salem starter Etienne. They added a run in the second on a single, an Etienne wild pitch, and a single to center.

Hugg and Mandrella combined for nine walks and eight strikeouts for Sterling

Heights.

Etienne pitched the first six innings for Salem, allowing three earned runs, five hits, five walks, and six strike outs. Dave Runge relieved him in the seventh, yielding two hits, a walk, and a strike out.

# Salem softballers thrash lowly Allen Park, 16-1

BY PATTY RADZIK

After two game cancellations, Mother Nature finally let the Salem High girls' softball team alone, holding the sky together long enough to permit a 16-1 thrashing of Allen Park at home yesterday.

Starting pitcher Jan Boyd was the key player of the game, tossing a three-hitter. She registered two walks and seven strikeouts.

Sue McDowell, a junior, went 3-for-4 at the plate, batting in four runs. Senior Becky Crespo knocked the Jaguar pitcher for three hits in five at-bats.

Salem scored in the first and kept the streak alive in every inning but the second. Nine runs were scored by the Rocks in the fourth and fifth innings combined.

Overall, Salem rallied for nine stolen bases, and committed two errors on the field. "I've never seen another Salem team play together like this one does," said Coach Levi Way.

"We took advantage of all the breaks," she said. "We used the squeeze play and their (Allen Park's) defensive errors to our favor."

Friday Salem will ply

Friday Salem will play its first home game of the season, when they take on Belleville High at 4 p.m.

The squad will keep busy this weekend, when the Rocks travel to Royal Oak to participate in the Shrine Invitational. Saturday the club will challenge St. Mary's Academy at 12 p.m.

The junior varsity Rocks exploded for 11 sixth-inning runs at Salem yesterday to bury Riverview, 18-8, in the club's season opener.



**E. Dale Lee**  
sports editor

## PCJBL President stands firm

Jim Schols can finally relax and enjoy life.

The Plymouth-Canton Junior Baseball League rookie president is now worrying about baseball instead of court battles. The three men and their attorney who had threatened to go to court over the team placement of a 12-year-old boy backed down, as expected.

It's rare that an organization with an almost entirely-new hierarchy can overcome this kind of adversity in its first year of working together. Schols almost quit because of the intense pressure three times, his friends tell The Crier.

I think Schols deserves some better treatment from this community. Not enough parents have volunteered to help out on the concession stands; and the league still needs fields.

Hats off to Schols and the Executive and Primary Boards for a job well done.

\*\*\*\*\*

Boston Marathoner Gene Kramer says he isn't going to stop running just because this year's race is over and done with.

"My feet are still sore, but I'll be up and at 'em soon," Kramer said. "The Marathon was an experience I don't think I'll forget, though."

Indeed.

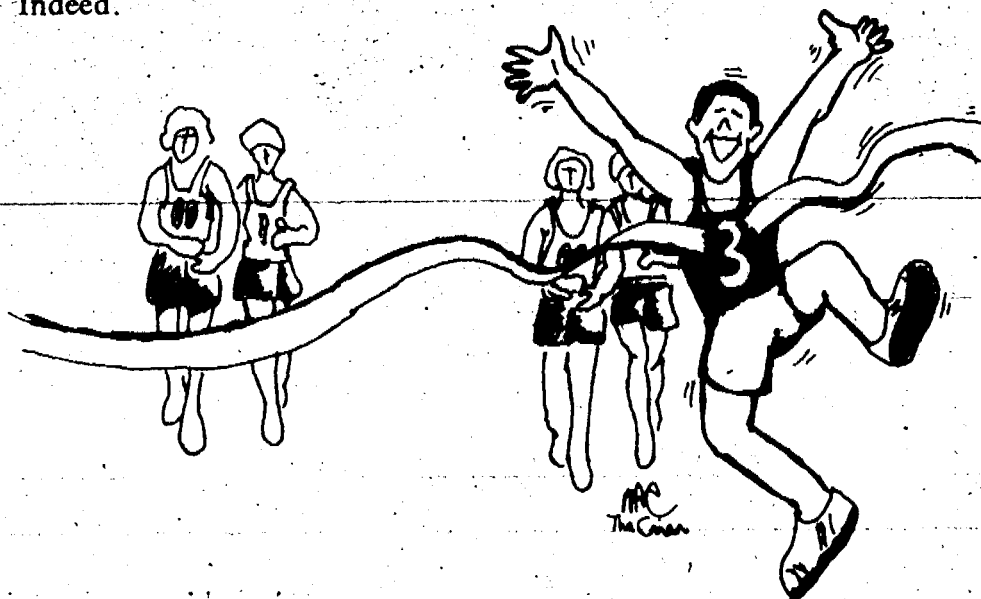

**JOHN H. GIBSON**

is moving up  
... and we're with him all the way!

An outstanding record of achievement during his first year with the Company has entitled this Woodmen Accident and Life Representative to membership in

## The Premier Club

... a special group of first year Representatives who have distinguished themselves by their contributions to the financial security of individuals, families and business through New Dimensions in life and health insurance.

Premier Club members are honored for both the high professional standards they have set for themselves, and for the potential they have exhibited for repeated success in the future.

Congratulations, John!

Your Company and your policyowners are with you all the way!

John H. Gibson  
P.O. Box 11  
Plymouth, MI 48170  
Ph: 453-8900  
Bruce F. Mirto, C.L.U.  
Agency Manager



Representing  
**WOODMEN**  
ACCIDENT AND LIFE  
A MUTUAL COMPANY ESTABLISHED 1890 LINCOLN, NEBRASKA

# Franklin hurler 1-hits Rocks in baseball opener

BY E. DALE LEE

Salem High fell victim to a one-hit Ken Webster mound masterpiece last Wednesday at home, losing to Livonia Franklin in the season's opener, 9-1. "He (Webster) threw a lot of fast-

balls in the 80 mile per hour range," Franklin manager Jerry Cullin said of the 5-11, 185-pound right hander. "Two years ago he threw a one-hitter for the jayvees."

Webster fanned six Rocks while walking two.

The lone Salem hit came in the fourth inning, when catcher Dave Wilcox singled. He also had a hand in the Rocks' only run.

Wilcox reached first leading off the seventh inning when the leftfielder committed an error. First baseman Jim Anderson walked before Sam Merrill

hit into a short, to second, to first double-play, and Wilcox went to third. He scored on a Webster wild pitch. Dave Runge struck out to end the game.

Matt Etienne started the game on the mound for Salem, but lasted only one and two-thirds innings before John Holdsworth relieved.

The Patriots opened the second inning with a long home run, a walk, and a ground out from short to first. Then a walk, an error by the center-fielder, and another walk loaded the bases. The next hitter struck out, but the next three walked, singled, and

singled for the seven run tally. The 11th hitter of the inning flew out to center.

Franklin added single runs in the fifth and sixth.

Etienne gave up two earned runs, four walks, three hits, and recorded two strike outs. Holdsworth lasted three and one-thirds innings, allowing an earned run, a walk, three hits, and earned two strikeouts. Runge pitched the last two innings, giving up an earned run, a walk, three hits, and a strikeout. Etienne took the loss.



**SPEEDY PRINTING CENTER**  
INTRODUCING THE  
**5¢ BOND COPY**  
8 1/2 x 11 Size  
**455-2350**  
**1170 W. Ann Arbor Rd. IN PLYMOUTH**

## Salem bounces Wayne Memorial, Thurston

BY E. DALE LEE

Senior catcher Dave Wilcox drove in three runs and batted 3-for-4 for Salem High at home Wednesday to power the Rocks to an 8-5 victory over Wayne Memorial.

The on-again, off-again Salem offense pounded out 10 hits against the Zebras. The Rock pitchers, Barry Owens and Dave Runge, held Wayne's offense to four hits combined.

Sam Merrill had a fine afternoon for Salem, going 2-for-3 with two runs batted in.

Owens pitched five and one-thirds

innings, yielding three earned runs, one hit, six walks, while striking out eight. Runge pitched the last inning and two-thirds, giving up two earned runs, three hits, no walks, and whiffing two batsmen.

Thursday the Rocks' offense mustered only five hits, but John Holdsworth held Redford Thurston High to four hits in winning, 4-2.

Thurston struck first with two runs in the opening inning on a triple, a base hit, a fielder's choice, a strikeout, and a single.

Jim Anderson led off the Salem fourth

inning with a walk and Wilcox singled. Merrill forced Wilcox and Matt Etienne drilled a home run over the right field fence for three runs. Owens then walked, Mike Woodard doubled and Owens scored when the Thurston catcher fumbled the ball with Keith Gruden at the plate. Paul Dillon walked and Paul Woodard forced him to end the scoring.

Holdsworth pitched six and one-thirds innings, giving up two earned runs, four hits, five walks, while striking out nine. Runge got the last two batters, garnering a strikeout in the process.



**Bill's Market**  
584 Starkweather  
Plymouth 453-5040  
**Beer & Wine to Take Out**  
**Groceries • Party Sancks**  
**• Meats • Sandwiches**  
**• Delicatessen**

## Salem, Canton runners compete in exhibition

BY PATRICIA BARTOLD

Some good results and some disappointing ones were tallied by the Salem High girls' track team Friday afternoon. The Rocks ran against seven area teams in an informal meet at home.

Ann Meixner hustled to a first place in the 220-yard hurdles in :32.5. Renee Slavin and Erin Lucas took second and fourth places respectively.

Lucas took first with a long jump of 15 feet, four inches. Diane Perpich snatched a second-place in the high jump with four feet, eight inches.

Salem runner Sharon Radionoff took

third place in the shot put and discus.

Rochelle Baltas ran the half-mile in 2:38 and Coach Scott Kurtz said he was happy with her time.

Other teams that competed in the scrimmage were Dearborn St. Alphonsus, Canton, Gabriel Richard, St. Agatha, and Dearborn.



RENEE SLAVIN

**SAM LERMAN M.D.**  
*Diplomate American Board of Family Practice*  
Canton Professional Park  
8552 Canton Center Road  
Canton, Michigan 48187  
**455-3530 DAY OR NIGHT**

**Book** ANNOUNCES A NEW POLICY:  
**Break 25% OFF**  
All fiction and Non-Fiction Hardcover titles found on Both the New York Times and Publisher's Weekly Best Seller Lists  
Hours: Mon thru Sat 10am to 9pm, Sun 11am to 6pm  
New Towne Plaza, 44720 Ford at Sheldon Rds. 459-0430

## Koufax baseball tryouts set

Tryouts for the Canton Koufax baseball team for boys who will be 13 or 14 on or before Aug. 1, 1979, will be held April 27, 28, and 29 at Central Middle School.

Manager Gerald Ebmeijer, who can be reached at 729-1370, says the team is restricted to those boys who will be or are attending Canton High School in the

fall.

\*\*\*\*\*

Tryouts for the Salem Koufax team will take place at East Middle School at 1 p.m. on April 29. Only those boys attending Salem High or will be attending there next fall are eligible for the team. For more information, contact manager Joe Carlson at 455-8026.





\$2.50 for the first 10 words, 10 each additional word

# Crier classifieds

Deadline: Monday 5 pm  
Call 453-6900

## Help Wanted

Plan your future. Part time. For interview call 459-9120.

Wanted — experienced, part-time bookkeeper, other secretarial duties as well; plus occasional full-time vacation fill-ins. 453-3636.

### NIGHT CASHIER

Looking for mature woman, able to work 3 nights per week, 6 p.m. to midnight. Enjoys public contact. Apply in person. Hillside Inn.

Part-time seamstress wanted. Apply in person at The Willow Tree, 298 Main in Plymouth. 459-4490.

LOSING THE BUDGET RACE? Help your income keep up with your outgo through pleasant part-time work. Assistance provided. Contact local Amway distributor. Phone 453-4105 for interview.

## Help Wanted

Fast-growing local company has positions open in marketing and management. Part-time. Flexible hours. By appointment only. 459-9763.

Babysitter for 3 children in my home. Start May 1, Mon., Wed. & Fri. 12 noon-4:30, \$1.50 hr. City of Plymouth. 459-9028.

### PUT AN EXTRA PAYCHECK IN YOUR POCKET.

Earn a second income selling Avon. Flexible hours. For information, call 291-7862.

Looking for someone with a large car or van, interested in working a half a day on Wednesday. Call Phyllis, 453-6900.

Registered nurse full-time afternoon shift. Apply in person. West Trail Nursing Home, 395 W. Ann Arbor Trail.

Licensed Prac. Nurse. Afternoon shift. Fulltime. Apply in person, West Trail Nursing Home, 395 W. Ann Arbor Trail.

## Help Wanted

IMMEDIATE opening for nurses aides on all three shifts. Apply in person. West Trail Nursing Home, 395 West Ann Arbor Trail.

NEED A JOB? Part time work for full time pay. Earn \$12 per hour. No collecting or delivery. \$400.00 wardrobe no investment +45% discount. Over 21. Car necessary. Will train. Call 981-0431 or 477-4231.

HOUSEWIVES AND STUDENTS if part time work is what you're after, come in and see us. Burger Chef Main Street, Plymouth.

Mature sitter wanted, my home. Monday through Friday 7 a.m. to 5 p.m. Respond after 5 p.m. 582-7915.

Colonial Pizza is accepting applications for part-time or full time delivery persons. We will provide vehicle and insurance. Applicants must be well groomed, 18 years of age or older and have an excellent driving record. 198 West Liberty, Plymouth.

Demonstrators - MERRI-MAC offers the best party plan program anywhere. Our guaranteed line of toys, gifts and super Hostess Program makes it easy for you to earn \$\$\$! No investment, delivering or collecting. Call collect now — Ann Baxter 319-556-8881 or write MERRI-MAC, 801 Jackson, Dubuque, Iowa 52001.

Dental assistant, experience desirable, Plymouth area. 453-9413.

PLANT LOVERS. Fast growing company has openings for manager trainee & plant demonstrator. Complete training program, full or part time. 525-1212.

AMBITIOUS persons who want to earn, but can only work part-time. Opportunity for good extra income. Training provided. No telephone interviews. For appointment, call Gene 455-7453.

## For Sale

Gold, plaid hide-a-bed. \$125. 455-0493 after 6 p.m.

Medium size glass display case. Suitable for jewelry, etc. Like new. 459-4170.

## Miscellaneous

Birch trees and seedlings. Early planting best results. 11211 Haggerty Rd.

## Vehicles For Sale

CAR 4 SALE  
1977 CHEVETTE, AM-FM stereo, A.C., rust proofed, \$2,600. Call Mary between 8 a.m.-5 p.m. 453-1515.

76 Mustang - Excellent condition, AM-FM stereo. Call 729-9234 after 5.

1975 Monarch Ghia, excellent condition, new tires, air, rust-proofed, new brakes and shocks, vinyl roof, 33,000 miles. \$2,600. 453-4077.

## Pets

Springer Spaniel stud service — liver and white - A.K.C. 455-1923

## Lost & Found

Lost boy's Schwinn Tornado bike, orange and yellow. Vicinity Ann and Farmer. Reward. 459-4263.

Lost 8-10 month old kitten. White legs; black 3" mark on one back leg. Wh.-dark grey coat. Answers to kitty or Johnny. Reward. Call 459-9552.

## Garage Sales

Moving-Garage sale. Fri.&Sat., April 27 & 28 th. 1007 Harding, Plymouth-9 to 6.

Yard Sale: April 28; 9:00-5:00. 493 N. Harvey household, toys, books, clothes.

Garage sale Thursday and Friday, April 26 and 27. 9 a.m. to 5 p.m. Drapes, jeans, dishes, knick-knacks, misc. 6132 New England Lane, Canton.

BASEMENT SALE April 27. and 28 from 9 a.m. to 5 p.m. 11459 Eastside Dr., Plymouth.

4 household huge yard sale. Sat. 28th. corner of W. Ann Arbor Trail and Beck. Wide variety of items.

## For Rent

V.F.W. hall for rent - weddings, graduations and parties — 455-8950.

RENT-A-SPACE at Northville giant garage sale. Over 150 spaces available on the Main street. May 19th 9:00 a.m. to 6 p.m. For space reservation, call Lapham Men's Shop 349-5175.

Year's lease. Reliable couple wanted for modern 2 bedroom in town Plymouth duplex with basement. \$340. monthly plus security deposit. No pets please. Call Jan 453-8200.

## Wanted

Wanted: Used metal file cabinets - regular & blueprint size. Call Mike at The Crier. 453-6900.

## Services

Lawn mowing services, five years experience. Call 453-3894.

FREE PREGNANCY TESTS - safe, legal abortion - immediate appointments. Helping women since 1972. Women's Center. 476-2772.

Puppet Shows: child's parties, schools, libraries, banquets, scouts, nurseries, 453-1566.

Interior decorating consultant, specializing in the comfortable home look, interior and exterior, references, reasonable. Ask for Gloria: 453-8641.

Discover a fresh new you naturally with the SHAKLEE BEAUTY BASICS. For your complimentary beauty hour Call C. Ellison. 459-8659.

## HEY! Guys & Gals

We have temporary assignments for packagers and light industrial in the Plymouth and Livonia areas. Work close to home and ask about our bonus program. Must be 18 yrs. or older with own transportation.

No fee                      No Contract  
Livonia ..... 525-0330  
If no answer call .... 967-0336

### WITT

The Temporary Help People

## College Students High School Seniors Teachers

Now is the time to register for temporary employment during your semester and summer breaks. Join the wonderful world of WITT. Work close to home - we pay top wages for top skills.

### WE NEED Secretaries—Typists All other office skills

No fee                      No Contract  
Livonia ..... 525-0330  
If no answer call .... 967-0336

### WITT

The Temporary Help People



Shop the great outdoors . . . INDOORS! Try

# The Crier CLASSIFIEDS

## DOG LICENSES

NOTICE  
TOWNSHIP OF PLYMOUTH

Dog Licenses are due prior to June 1, 1979 and are available at the Plymouth Township Hall, Treasurer's office, 42350 Ann Arbor Road, Plymouth, Michigan, Monday through Friday, 8:30 a.m. to 5:00 p.m.

License prior to May 31, 1979. \$3.00  
License after May 31, 1979. \$5.00

Dogs must have a current rabies vaccination and owners must show proof of vaccination when obtaining dog licenses. Owners of all dogs not vaccinated and licensed before June 1, will subject to violation tickets.

Please remember you are also in violation if your dog is permitted to run at large or its frequent whining barking, yelping or howling shall cause serious annoyance to the neighborhood or to persons passing to and fro upon the public highway.

Publish April 11, 25 and May 16, 1979.

JOSEPH H. WEST  
PLYMOUTH TOWNSHIP TREASURER

\$2.50 for the first  
10 words. 10 each  
additional word

# Crier Classifieds

Deadline:  
Monday 5 pm  
Call 453-6900

PG:  
41

THE COMMUNITY CRIER: April 25, 1979

## Curiosities

**MELANIE:** a little spring FEVER?

**ARE YOU SURE** you're not hiding Bruce under the front porch, Mike?

**PAT. B. hugs!** (at least I don't KISS and tell)

I realize I don't clean off my desk very often . . . but wait till you guys see what I found under a pile of old cut-books and comp sheets . . . it weighs 500 lbs. and it sleeps by a clean electric line.

Congratulations to Sam Panzica and company on the opening of the new Plymouth Landing.

## Curiosities

**Keiko eats cherry cheese cake** on her birthday, but Tucker didn't get any.

**Stae rekcut**

**Hats off to Florence Beier.** Thanks for the menus.

**Jim Shields does a great job** of putting up clothes lines. Thanks.

**A STAR MAY** have been born in New York, but she came home anyway.

**SAY FELLA!** That's a nith earring.

**MARY ELLEN** - welcome aboard. Your desk is zoned R-1.

## Curiosities

### EYE CATCHERS

Misties, candlelights, environmentals, and so much more to add that special touch to your wedding photography.

Rawlinson Photography 453-8872

Electrolysis by Charlotte . . . complimentary consultations at The House of Glamour Salon. 453-5254.

Congratulations **RUBY CALDWELL**, you are this week's \$10 gift certificate winner at **YOUNG SOPHISTICATS**.

**REMODEL** your bath the easy way with a fiberglass tub wall kit — now 15 per cent off. Family Bath Boutique. 875 Wing. 459-1680.

## Curiosities

### ANTIQUe SHOW AND SALE

April 27, 11 a.m. - 9 p.m.

April 28, 11 a.m. - 6 p.m.

St. Andrew's Episcopal Church  
16360 Hubbard Rd., Livonia  
S. of W. 6 Mile: E. of Farmington Rd.  
Buffet Served, Donation \$1.

Old Village Gallery of Framing: for that custom touch, see us! 383 Starkweather.

**Q.** What local newspaper publisher is married to a union president?  
**A.** Don't ask me, I just work here.

**AMAZING!** Gail makes it! — Our home-made lasagna, that is. Home delivery by Colonial Pizza.

## PLYMOUTH-CANTON COMMUNITY SCHOOL DISTRICT BOARD OF EDUCATION MINUTES

This is a synopsis of minutes of the Plymouth-Canton Board of Education for the period of January through March 1979. Complete minutes and tape recordings of deliberations may be obtained by calling at the Board of Education Offices, 454 S. Harvey St., Plymouth.

January 8, 1979. All members were present at this meeting. A slide-tape presentation on Safety prepared by the TAG program at Tanger School was the first order of business. Citizens comments at this meeting included support and appreciation by Mrs. Sharon Young for the services to this district of Mr. Gary Quitiquit in Special Education, and comments regarding Board meeting procedures by Mr. Larry Morin.

Announcements included setting of graduation dates of June 14 for Salem and June 15 for Canton High Schools, and that the Wayne County Road Commission is considering purchase of .734 acres next to Gallimore School for use in widening Sheldon Road. Administrative reports included resume of special election preparations for January 18, and report on survey of families who have left the District. Recommendations were made for use of printing facilities and keeping printing costs down in the District. Auditor's recommendations status report was given to the Board by Dan White. A disaster-emergency plan in conjunction with the City of Plymouth was discussed.

New Business included approval of bills for payment in the total amount of \$1,938,786.70, and acceptance of teacher resignations from: Teresina Pis, Marion Scott, and Kenneth Zornes. In addition, the Board accepted with regrets the resignation from Gary Quitiquit, Supervisor of Special Education. Contracts were then approved for the following new teachers: Deborah Conti, Linda Kleinow, Christine Matson and Laurie Schoultz; and the Board ratified the agreement reached between the School District and Local 547 for the 1979-80 school year.

Board comments included commendations for procedures at the Centennial Park with arena scheduling and with the Helping Hands program in the community. All citizens were reminded to vote on January 18 in the millage renewal election.

January-22, 1979: All members in attendance at this meeting, except Member Gray. A closed hearing regarding expulsion cases was announced for January 25, at 7:30 and at 8:30 p.m. A workshop sponsored by the Michigan Association of School Boards was announced for February 9-10, and the meeting of the executive committee of the Wayne County School Board regarding implementation of Headlee amendment was also discussed. Administration reported on MAISL (Michigan Assn. for Improved School Legislation) meeting. Richard Olenchak reported on the status of the Talented and Gifted Program in this school District.

Old Business included recommendation on amendments to the open purchase order procedure, and after a great deal of discussion, the matter was passed, with Member Harper dissenting. Under New Business, bills for payment in the total amount of \$1,675,129.91 were approved. The Ward Presbyterian Church was granted permission to hold Sunday services in the Laibister School multi-purpose room and in five classrooms. A maternity leave of absence was granted to Marcia Moore from West Middle School and replacement-teacher contracts were granted to Linda Gottwald, Randy Gorham and Linda Mapes. The negotiating teams for the various contracts to be considered during this year were approved. A resolution regarding the International Year of the Child, 1979, was adopted. Attendance at an AASA Conference on February 18 and at AMA Seminar on February 26 to March 1 was approved for the Superintendent. In addition the travel requests of Dr. Page, Dr. Riegel and John Bulmer were approved for attendance at a National Assn. for Children with Learning Disabilities; Delegates for the Wayne County Intermediate School District budget meeting were also approved. Arbitration-Grievance No. 78-79-2 was approved between Plymouth-Canton Education Assn. and the administration with regard to certain elementary school hours.

Persons who had worked on behalf of the millage election were thanked for the time and effort for a successful vote. A TAG workshop was announced for March 5, and inservice day announced for March 19 at Allen School. Boundary proposal schedules were also discussed. A field trip which had been cancelled and which had caused some parent concern was explained to the Board. Precinct workers who have given long years of service to the District at election times were thanked by Board members, and a fine inservice presentation on CPR training by Mr. Lutz and Smith School staff was noted.

February 12, 1979: All members were present. Announcements included an invitation to Board members and friends to celebrate opening of new Community Crier offices; a breakfast meeting for legislators and Board members; and a schedule for activities of the Boundary and Growth Committee. Administration presented a status report and revised 1978-79 General Operating Fund Budget, with total revised fund balance projected to be \$625,689 at this point, and total budget breakdown as follows:

Operating Budget	\$28,546,363
Project Budget	1,207,159
Total	\$29,753,522

It was noted that this budget would be \$865,447 higher than 1978-79 revenues. A recommendation was made by administration to use Livonia Public Schools Warehousing services, effective July 1, which would result in lower prices, freeing space presently used in Plymouth-Canton District for warehousing, and taking advantage of years of experience of Livonia personnel. The motion carried unanimously; with the added stipulation that the Board receive a progress report about six months after the program has begun. A Pre-School Program Overview was also given by administration, and the report accepted unanimously, as well as a report on Centennial Educational Park Delivery System Evaluation. A recommendation was also made that no PACTS Assembly be held in 1979 since concerns identified by building-level PACTS are now being studied by other committees in the District.

Old Business: Member Gray asked for an update on the status of reading and spelling programs as previously adopted by this Board. Activities in this area were reviewed by administration, including testing programs, inservice projects, and use of various types of reading programs.

New Business: Attendance at the National School Board Association convention in Miami was approved for Treasurer Stephen Harper. Bills for payment in the total amount of \$1,462,550.96 was also approved, as well as maternity leaves of absence for Sandra Fuller and Kathleen Lowernick. Resignations were accepted from teachers Janet McCassey and from Margaret McMaster. Both teachers were commended for their outstanding services to this District. Teacher contracts were approved for Constance Kelber, Michael Moore and Patricia Rupert. A proposed Board by-law No. 9004.9, Travel by Board Members, was accepted for first posting. Board members commented as follows — Mr. Harper noted that he had attending Wayne County Intermediate School District Annual Budget hearing; the Superintendent added that a Senate hearing on educational reforms would be held on February 26; and Mrs. Tonda asked the

newspapers to help with publicity regarding the State's so-called refunds on property taxes, and which refunds are credited to education. The Open Meetings Act was discussed, and Mrs. Davis then commended the Cafeteria employees on the good health inspection rating received from the State.

February 26, 1979: Member Tonda was absent from this meeting. A film entitled "Close Up" was shown to the Board from the CEP, and Ms. Kelly Hubert described her activities as a student in Washington, D. C. under that program. Citizens comments were received from Mrs. Nancy Bane, representing the Canton Citizens' Organization for Action, which is concerned with boundary changes south of Ford Road in Erikson attendance area, and with possible change to traditional from ESJ at Pioneer Middle School. Other citizens were asked to come to the Boundaries workshop to be held on March 6. Announcements were made as follows: That a workshop of Wayne County School Board would be held on March 1; that a Talented and Gifted Program would be held at Salem High School on March 5; and public hearing was again stressed on March 6 regarding proposed boundary changes. A possible Executive Order from the Governor was also discussed which might reduce revenue to this District.

New Business: Bills for payment were approved in a total amount of \$1,143,911.16. A proposal to purchase seventeen 66-passenger buses and five 23-passenger buses was received from administration and reviewed by Mr. Hoedel. The above motion to purchase was tabled until a later date, by unanimous vote. The Board of Education pending necessary legislation being passed in Lansing, approved the use of Plymouth Community Federal Credit Union as depository for certain school funds. A sabbatical leave of absence request for Ms. Barbara Masters was not approved by unanimous vote of the Board. Resignation of Roseann Balmas was accepted, and maternity leave approved for Judith Ray. New teacher contract for Rosemary Verville was also approved. The proposed Board by-law on Travel by Board members was adopted on second posting. The Board commended Ms. Joyce Willis for her fine student placement activities at the high schools; Member Gray asked for further status report on reading materials; Member Harper asked for more Federal Projects data, being concerned that the District might be responsible for certain funding if such monies were not received from Federal funds. This meeting was adjourned to receive more information from the Boundary and Growth Committee.

March 12, 1979: All members were present. An interim report was received from the Citizens Bond Advisory Committee, and a presentation on Movement Education at Smith and Hulsing Schools was made by Linda Kowalczyk, and by Principal Bill Lutz. Minutes were approved for the meeting of February 26, and for special closed meeting of the Board held on January 25 which had been closed for expulsion hearings. Announcements were made regarding an invitation to Board members to attend Business-Education Forum on March 30; a workshop sponsored by PCEA and PCOS on School-Community Relations to be held on April 3; and a public hearing on 1979-80 proposed operating budget to be held on March 21. A closed executive session of the Board was announced for March 29 to review contract language and non-certified contracts; the National Honor Society convocation was announced for March 14; Mr. Hoben then read a letter he was sending to a newspaper which had downgraded Mrs. McMaster's services to this School District and the community. Reports were received from administration regarding the fact that a possible Executive Order would not be effected at this time, therefore causing no cutback in funds from the State to the District. Interested persons were asked to attend public hearings on Interscholastic Athletics to be held by the State Board of Education. The possibility of a District-wide Media Center was discussed by administration and the Board. However it was felt that the possible cost would be prohibitive at this time. The Board accepted the Report, including the recommendation that the concept be studied further; it was to be discussed at Administrative Cabinet level. An ESJ Evaluation was presented to the Board and accepted.

New Business: The resignation of Pearl Lim was accepted by the Board and leave of absence granted to Laura Wiener. New teacher contract was approved for Judith Richards as School Psychologist, Farrand School. There was discussion regarding Federal or State funding; possibility of loss of such funding and whether this District would be liable for continuation of contracts. The vote to approve the contract was carried unanimously. Checks in the amount of \$1,234,766.86 were approved. The Board received a request for reinstatement from school expulsion, but the request was denied until reconsideration in the fall. There was a motion to consider the subject at a workshop private session, but the motion failed. Comments from the Board included an announcement that grievances from PCEA would be heard on March 19; Boundary and Growth Committee would present further recommendations at this meeting. In answer to a question, the Board was informed the District has no trampolines in use. Member Arlen also reminded the Board that evaluation time for staff is at hand, and comments should be returned to Mr. Kee by April 15. Mrs. Davis noted the workshop on writing to be held at Canton Little Theater on March 16.

March 26, 1979: Members Gray and Yack were not present at this meeting. Vice-President Arlen presided. A special meeting had been held prior to the meeting to hear a parent's request, and also to hear Grievances No. 13 and No. 16. Mr. Larry Bell then asked the Board for more information regarding a bus accident on March 26. Announcements were made regarding Wayne County Assn. of School Boards annual meeting on April 5, and that the Reading Reform Foundation has been asked to send more information to the District regarding their programs and studies.

Old Business: The matter of purchase of buses was removed from the table, and consideration given to purchase of ten 66-passenger buses and three 23-passenger buses. After a great deal of discussion, the matter was again tabled, with Member Arlen voting against that decision.

New Business: Bills for payment in the total amount of \$1,061,353.40 were approved and the proposed 1979-80 Wayne County Tax Allocation Budget was adopted, with \$33,315,414 proposed for General Fund expenses for the next school year. Resignations were accepted from Michelle LaMirand, Barbara Velzy and Betty Walker, and leave of absence granted to Karen Myers. Ms. Walker's years of service were commended by the Board. New teacher contracts were approved for Howard Eule and Marianne Tracy. Grievance No. 78-79-15 was reviewed, and presentation of administration approved, noting no basis for consideration as a grievance. A new Advisory Committee on reproductive health curricula was adopted, membership to be 20 persons at the present time representing clergy, parents, educators and students, and to be chaired by Mrs. Shirley Cunningham, School Nurse. It was felt the program would not be effected until 1980-81 school year. The Board adopted a resolution to establish a Citizens Election Committee, open to all residents of the District, in order to assist in planning for possible millage election in June 1979; first meeting to be held April 10.

The matter of Metropolitan Achievement Tests scheduled for fifth-grade students was raised and questions answered on their usefulness. A Board executive session was announced to be held March 29 for discussion of negotiations strategy.

Please note again that the above represents only synopsis of minutes. Please feel free to ask for information regarding any subject at the Board of Education offices, 454 S. Harvey Street.



\$2.50 for the first 10 words, 10¢ each additional word

# Crier classifieds

Deadline: Monday 5 pm  
Call 453-6900

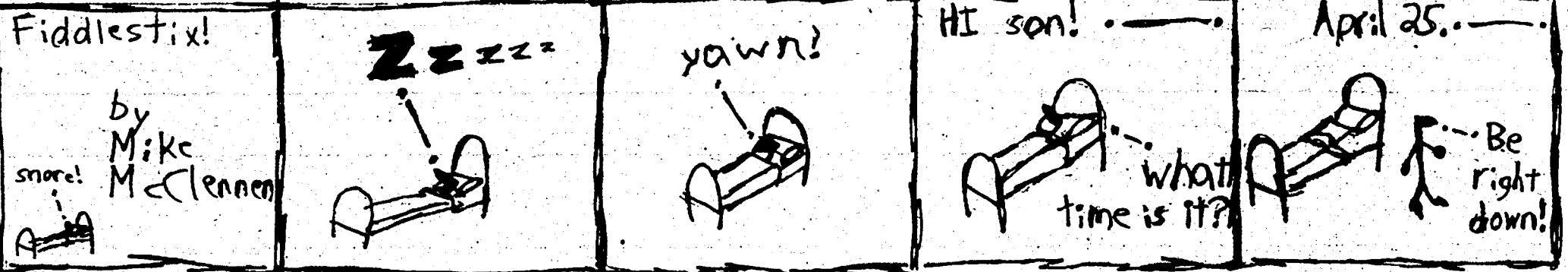

**NOTICE OF PUBLIC HEARING**  
ZONING BOARD OF APPEALS  
CITY OF PLYMOUTH, MICHIGAN

At a meeting of the Zoning Board of Appeals to be held in the Commission Chamber of the City Hall on Thursday, May 3, 1979, at 7:30 P.M., a public hearing will be held to consider the following:

APPEAL CASE NO. 79-9 - JACK COXFORD, 1445 Penniman Avenue, Plymouth, Michigan 48170, requesting permission to construct a new single-family residence, 3.9 feet from the south property line, at 767 Fairground Avenue (Lot No. 14, Fairground Subdivision) located in a R-1 (Single-Family Residential District) zoning, which is in conflict with Section 5.185, Article XIV of Chapter 52, Zoning, of the Plymouth City Code.

Section 5.185 provides that the minimum side yard set back in a R-1 District shall be 6 feet. All interested parties will be given an ample opportunity to participate in the hearing and at the close of said hearing, all comments and suggestions of those citizens participating will be considered by the Zoning Board of Appeals, prior to rendering its decision.

Paul V. Brumfield  
City Clerk

Publish: April 25, 1979

**TOWNSHIP OF PLYMOUTH**  
BOARD OF TRUSTEES - SPECIAL MEETING  
MONDAY, April 16, 1979

A Special Meeting of the Board of Trustees of the Township of Plymouth was called to order by Supervisor Thomas Notebaert at 7:30 p.m. He led in the Pledge of Allegiance to the Flag. All trustees were present except Gerald Law who arrived at 7:43 p.m.

Notebaert announced the Special Meeting had been called for the purpose of discussing future plans and capital improvements of Township lands and buildings and also approval of the sewer easement across Ford Motor Company property for Bob Jeanotte Pontiac Dealership, Application No. 436.

There was much discussion of past plans and current needs of the Township to which both Trustees and attending citizens spoke.

It was agreed that priority, timing and financing of capital improvements is needed. A plan should be developed for six years with yearly updating by the Planning Commission. A long range committee with members from the Planning Commission and Board of Trustees, as well as citizens with expertise should be appointed to study all of the plans, prioritize the needs in four general categories: General Administrative, public works, public safety and parks and recreation.

Fidge asked as a first priority that it be determined what surplus lands are available, where they are and what they will cost.

Lynch and Hulsing are to look into varying types of bonding available to the Township. It was the consensus of the Board they did not wish to consider the approval of the sewer easement until April 24, 1979.

It was moved by Hulsing, supported by Lynch that the meeting adjourn at 9:55 p.m. Ayes all.

Approved,  
THOMAS G. NOTEBAERT, SUPERVISOR

Respectfully submitted  
ESTHER HULSING, CLERK

Minutes are a synopsis. Official minutes are on file in the Clerk's Office.

**POSTING AND FILING OF CITY COMMISSION MINUTES**  
CITY OF PLYMOUTH, MICHIGAN

Notice is hereby given that on the 24th day of April, 1979, true copies of the minutes of the regular meeting of the City Commission held on Monday, April 2, 1979, at 7:30 P.M., were posted on the official bulletin boards of the City of Plymouth, located at the Southeastly corner of the intersection of S. Main Street and Penniman Avenue; the Southeastly corner of the intersection of Starkweather Avenue and W. Liberty Street; the South entrance of the Central Parking Lot facing S. Harvey Street; and also on the bulletin board in the City Hall at 201 S. Main Street. These minutes are posted in accordance with Section 5.11 of the City Charter for the benefit and information of all interested citizens of the City of Plymouth.

Paul V. Brumfield,  
City Clerk

Publish: April 25, 1979

## Crier classifieds

Reach the people  
in YOUR community

Call: 453-6900

or clip & mail this form today!

10 Words- \$2.50  
Extra Words-  
10¢ each

Deadline:  
5 pm Monday for  
Wednesday's Paper

Write Your Ad Here:

\_\_\_\_\_

\_\_\_\_\_

\_\_\_\_\_

\_\_\_\_\_

\_\_\_\_\_

Mail to:  
**The Crier**  
1226 S. Main St.  
Plymouth, Mi. 48170

Your Name \_\_\_\_\_ Phone \_\_\_\_\_

Address \_\_\_\_\_

## service directory

<p><b>MODELING</b></p> <p>for CHILDREN &amp; ADULTS</p> <p>North American Mannequins 1474 Ecorse Rd Ypsilanti - 483-7161</p>	<p><b>Having a party?</b></p> <p>English Free-lance home economist. Let me plan, shop for, prepare, cook, and if required, serve your next dinner party or brunch. Any entertaining function catered for. Also food for the freezer, tortes, etc. English cookery and cordon-bleu a specialty. Call 455-9293.</p>
<p><b>ALTERATIONS</b></p> <p>(Men's clothing and ladies tailored suits and slacks.)</p> <p>Regardless of where you purchased them - Satisfaction Guaranteed!</p> <p><b>LENT'S CUSTOM CLOTHING</b></p> <p>Plymouth 453-5260 Our own Tailor on premises.</p>	<p><b>PIANO TUNING</b></p> <p>Jim Alexander - 459-4646 Professional tuning, regulating &amp; Repair. Call 5 p.m.</p>
<p><b>R&amp;R Painting</b></p> <p>453-6785</p> <p>References - Professional Results - Free Competitive Estimates - Specializing in Window Glazing</p>	<p><b>PAINTING INTERIOR AND EXTERIOR</b></p> <p>Ceiling &amp; wall repair. FREE ESTIMATES. 721-5006 Daily 729-8547 after 5 or weekends. No job too small-phone NOW &amp; SAVE</p>
<p><b>WOOD DECK PATIOS CUSTOM BUILT</b></p> <p>Wolmonized (rot proof) References and photos of past workmanship &amp; design. Constructed quickly &amp; efficiently. Complete interior remodeling one of our specialties. Licensed.</p> <p><b>R. MONTRY CONSTRUCTION</b></p> <p>(313) 453-6172 (517) 546-4375</p>	<p><b>DAVE'S CARPET CLEANING</b></p> <p>Carpet sales &amp; service. Also furniture cleaning. 459-3090</p>
<p><b>Plymouth Janitorial Service</b></p> <p>Professional OFFICE CLEANING</p> <p>Hours at your convenience. References. Let our staff handle what you can't don't have time to do.</p> <p>Our business is to please YOUR customers</p> <p>453-8297</p>	<p><b>The Crier Classifieds are YOUR neighborhood marketplace!</b></p>

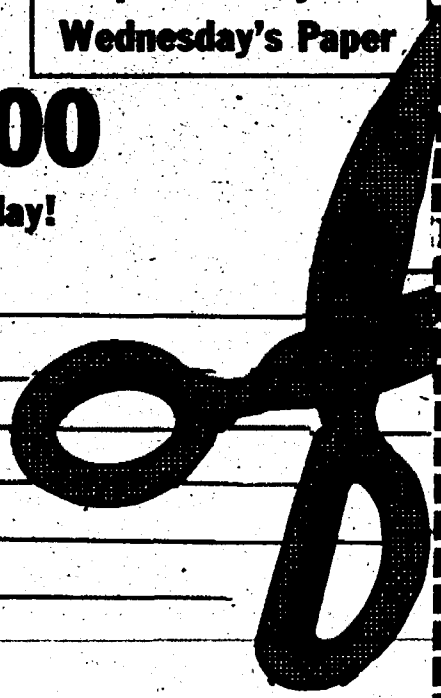



Help is just  
a phone  
call away

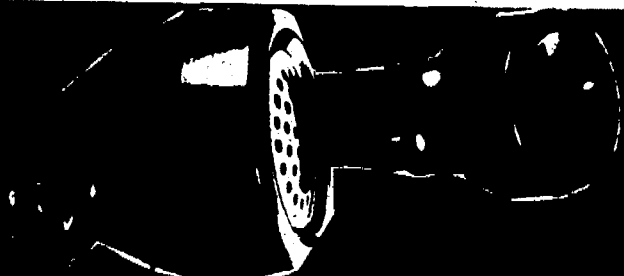

# Dial-It Shopping

PG 43

THE COMMUNITY CRIER: April 25, 1979

## Alarms

**MIDWEST ELECTRONIC SECURITY**  
36343 Ford Rd.  
Westland  
721-3894

Commercial and Residential Security Systems \* Installed \* Wireless Portable Alarms \* Visit Our Showroom.

## Auto Repair

**DENNY'S SERVICE**  
1008 Starkweather  
Plymouth  
453-8115

Front end work \* tune ups \* general repair \* certified mechanics \* towing \* Open till midnight for repairs.

## Bakery

**MARIA'S ITALIAN BAKERY**  
115 Haggerty - 981-1200  
38411 Joy Rd. - 455-0780  
\* Square Pizza \* Hot Italian Bread \* Sausage \* Baked Goods \* Cannoles \* Cakes \* Italian Lunch Meat \* Beer \* Wine.

## Barber-Styling

**MYRONS BARBER SHOP**  
917 S. Main  
Plymouth

Mens and wome. cut and styling, closed Mondays, open Tuesday thru Friday 8:30 to 5:30, Saturday till 4:00. Craig Duke, Myron Hopper, Owner.

## Bath Boutique

**FAMILY BATH BOUTIQUE**  
875 Wing St.  
Plymouth  
459-1680

Everything for your kitchen and bath \* Remodeling \* Repairs \* Bath Accessories \* Do-it-yourself Headquarters.

## Bookstore

**PLYMOUTH BOOK WORLD**  
2 Forest Place Mall  
Plymouth  
455-8787

Expand your horizons \* Read a book today \* Unique Children's selection \* Discriminating magazine corner \* Refreshingly different cards and gifts.

## Bowling

**CANTON BOWLING & TROPHY SALES**  
45480 Ford Rd.  
Canton  
459-5530

Expert Fitting & Drilling - Complete line of quality equipment - Extensive trophy selection - Engraving - Youth program.

## Bridal Shoppe

**GENEVA'S OF PLYMOUTH**  
17 Forest Place  
Plymouth  
455-4445

Wedding Gowns \* Accessories \* Cocktail Dresses and Prom Gowns \* Appointments Available.

## Carpet

**DAVE'S CARPET CLEANING**  
640 Starkweather  
Plymouth  
459-3090

\* SALES-Lee's-Bigelow - Cranbrook- \* CLEANING-Dry Foam Shampoo- \* REPAIRS- \* INSTALLATION-Professional service on all carpet.

## Carpet Cleaning

**BOYLE'S CARPET SERVICE**  
11608 Stark Rd.  
Livonia  
525-9038

CARPET CLEANING \* SALES AND INSTALLATION \* Samples shown in your home \* ALL WORK GUARANTEED.

## Dance Instr.

**MICKIE'S DANCE COMPANY**  
7329 Lilley Rd. (at Warren)  
Canton, MI (Kings Row)  
459-1760, 427-4873

All Types of Dance Available. Mickie Gaffke - B.S. Dance & Drama, Director - D.M.M., Member - D.M.A., M.D.A., D.M.D.P.

## Drive-In

**A & W OF PLYMOUTH**  
208 Ann Arbor Rd.  
Plymouth  
453-4886

Featuring Real Ice Cold A & W draft root beer \* Great sandwiches \* Friendly atmosphere \* Drive-In or Take-out Service.

## Electrician

**SAMSONOW ELECTRIC**  
195 S. Mill  
455-1166

Complete electrical service. Commercial & residential \* Industrial. Electric Heating, electrical code violations corrected. Electrical repairs.

## Engraving-Jewelry

**ENGRAVING CONNECTION**  
470 Forest Avenue  
Plymouth  
459-3180

Mothers Day for stick pins, necklaces, etc. \* Anniversary and baby gifts. Yours or our merchandise \* Rubber stamps \* 24 hr. service.

## Floorcovering

**FLOOR FASHIONS OF CANTON**  
5854 Sheldon Rd.  
Harvard Square Shopping Ctr.  
459-6180, 453-7777

Complete Decorating Center: Carpet \* Tile \* Vinyl & Wood Floors \* Paint \* Wallcovering \* Draperies \* Wovenwoods \* Shades \* Levelor's \* Shutters.

## Florist

**HEIDE'S FLOWERS**  
Ann Arbor Trail at Harvey.  
453-5140

Largest selection of Fresh, Dried & Silk Flowers. Also featuring Wicker, Stuffed Animals, Brass & Pottery. Daily Deliveries.

## Furniture

**LAUREL FURNITURE**  
Complete home furnishings. Large selection of baby furniture and clocks. Quality furniture moderately priced. Free delivery.

584 W. Ann Arbor Tr.  
Plymouth  
453-4700

## Furniture Refin.

**FURNITURE REJUVENATION UNLIMITED**

Old Village - Plymouth  
882 Holbrook 459-4930  
Natural & Painted Finishes  
Wood Repair - Woven Seats  
Hand Stripping  
Wicker Repair

## Hair Cutting

**BEAUTIFUL PEOPLE**  
450 Forest  
Plymouth  
459-2880

Professional Hair Care is present today wherever fashionable American women & men go -

## Hall For Rent

**VFW 6695 PLYMOUTH**  
1426 S. Mill St.  
Plymouth  
455-8950

Weddings, graduations, anniversaries, meetings, fund raisers. UNDER NEW MANAGEMENT.

## Home Maint.

**SALEM STEAM CARPET CLEANING**  
Plymouth  
981-0202

Spring discount. Professional installation sales & service on all carpeting. 24 hour service.

## Insulation

**AIR TITE INSULATION**  
882 N. Holbrook  
Plymouth  
453-0250

Save on the cost of heating - cooling. Fast, professional installation - "your comfort is our business."

## Int Decorating

**GRANATA FURNITURE**  
331 N. Main St.  
Plymouth  
453-3370

The finest of contemporary, traditional and country furniture at affordable prices \* Interior decorating at no extra charge.

## Ladies Fashion

**HELEN'S FACTORY OUTLET**  
425 Inkster Road  
Garden City, Michigan  
425-8600

Classic Styles and up to date coordinated fashions in sizes 3 thru 46 Tues.-Sat. 10-5:30, Thurs. till 8:30.

## Landscaping

**GOOD'S NURSERY**  
51235 W. Ann Arbor Road  
453-2126

Complete Landscaping; Your plan or ours \* Good selection; trees, bushes, shrubs, flowers. Monday-Saturday 9-5:30; Sunday 12-5:00.

## Lawn Maintenance

**DAN'S LAWN SERVICE**  
455-9575

If no answer, call after 5 p.m. Spring Clean Up \* Lawn Repair \* Snow Removal \* Free Estimates.

## Linen & Gifts

**BED N STEAD**  
6 Forest Place  
455-7494, 455-7380

Featuring linens for beds, tables, and bath. Candles \* Scandinavian Imports \* Hand-crafted Gifts \* Unusual Christmas Ornaments.

## Photographer

**RAWLINSON PHOTOGRAPHY**  
453-8872

Specializing in location photography such as weddings, anniversaries, environmental portraits, teams, senior portraits and others.

## Pizzeria

**BEE JAY'S KITCHEN**  
628 S. Main  
Plymouth  
455-8010

Take Out and Fast Delivery: Very Best Pizza, Ribs, Fish, Shrimp, Chicken, Spaghetti and Scallops.

## Plumbing

**JOHN J. CUMMING PLUMBING**  
1425 Goldsmith  
Plymouth  
453-4622

Kohler plumbing fixtures. Residential \* Commercial \* Repairs \* Modernization \* Rheem water heaters.

## Real Estate

**REALTY WORLD**  
Wm. Decker, Inc.  
670 S. Main St.  
Plymouth  
455-8400

"Our World Revolves Around You."

## Resale Shop

**HIDDEN TREASURES**  
728 S. Main St.  
Plymouth  
459-9222

Good, previously owned furnishings \* Children's Toys, needs \* Sporting Goods \* Lots More \* Monday-Saturday 10:00-5:30, Fridays till 8:00.

## Slip Covers

**CUSTOM GALLERY**  
455-3074

Custom made Slipcovers \* Shop at home service \* Also: Draperies, Upholstering, Levelor Blinds, Woven Woods \* Free Estimates \* VISA \* MC.

## Wallpaper & Fabric

**JUST ANN'S**  
746 Starkweather  
Plymouth  
459-5444

Largest selection of decorator wall coverings & fabric in area. Drapery, upholstery services. 9:30 - 5 Mon. thru Sat. or by appointment.



MR. COLONY SEZ:

# CATCH MY DEAL!!

Marino's Colony Chrysler-Plymouth is Your 'HOME TEAM'

These 'Across The Plate' Pitches Are 'Solid Hits!!'

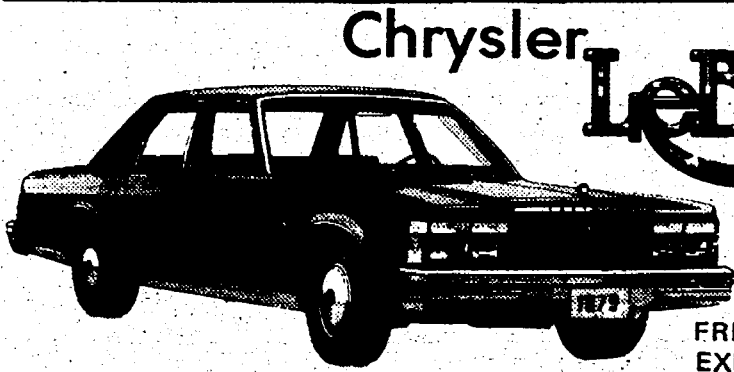

Chrysler  
**LeBARON**

FREE 5/50 WARRANTY  
EXPIRES MAY 10, 1979

**\$4999<sup>00</sup>**

**\$299 down**  
**\$125<sup>33</sup> month**

To Qualified Applicants -  
48 mos. - APR 12.68%

'Triple Special'

Plymouth

**CHAMP**

- FRONT WHEEL DRIVE
- HIGH MPG
- LOW COST

FROM  
**\$4298<sup>00</sup>**

**\$298 down**

**\$106<sup>66</sup> month**

To Qualified Applicants -  
48 mos. - APR 12.68%

(& tax,  
title &  
license)

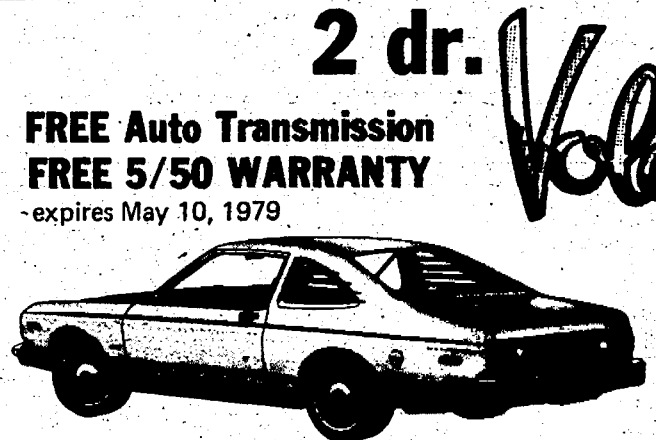

2 dr. **Volare**

FREE Auto Transmission  
FREE 5/50 WARRANTY  
- expires May 10, 1979

**\$4595<sup>00</sup>**

**\$299 down** and tax, title  
& license

**\$114<sup>66</sup> month**

To Qualified Applicants -  
48 mos. - APR 12.68%

'Double Special'

**'79 ARROW**

- BIG ECONOMY
- LOW COST

**\$288 down**

+ tax, title & license

**\$117<sup>32</sup> month**

To Qualified Applicants -  
48 mos. - APR 12.68%

FROM  
**\$4688<sup>00</sup>**

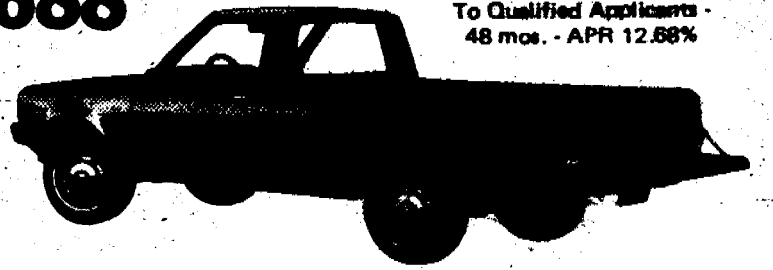

## Visit COLONY'S USED CAR 'BULLPEN'

These 'stars' are all warmed up, ready for a new home—extended warranties available

1976 CHRYSLER CORDOBA extra sharp \$3595<sup>00</sup>

1974 PLYMOUTH FURY WAGON vacation special \$1595<sup>00</sup>

1978 VOLARE PREMIER SEDAN absolutely new \$4495<sup>00</sup>

1977 CHRYSLER CORDOBA CPE. fully loaded \$4395<sup>00</sup>

1975 CHEV. CAMARO CPE. sporty & nice \$3495<sup>00</sup>

1976 PONTIAC GRAN PRIX's 2 to choose from \$3545<sup>00</sup>

1977 T BIRDS (3) ready to fly \$4495<sup>00</sup>

1976 DATSUN CPE. B210 \$2795<sup>00</sup>

1978 CHRYSLER SEDAN new - 4,000 miles \$4995<sup>00</sup>

1977 LINCOLN CPE. newest in town \$6595<sup>00</sup>

FOR RENTAL OR LEASING CONTACT MR. HENNING AT 453-2255

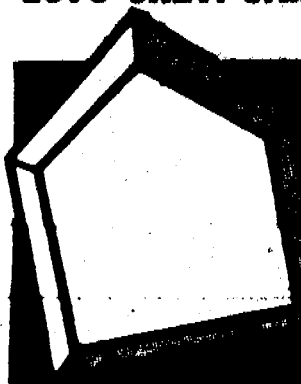

DOM MARINO'S  
**Colony**

CHRYSLER  
PLYMOUTH