

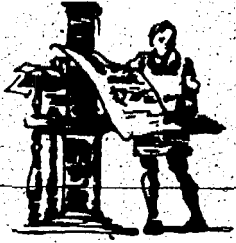

## Parents protest

LAST NIGHT about 320 persons gathered to protest proposed boundary changes and the elimination or extension of the extended school year program before five members of the Plymouth-Canton Board of Education. Held at the Canton High Little Theater, the public forum was sparked by applause and groans as about 20 persons expressed their views. For more on the story, see pg. 9. (Crier photo by Bill Bresler)



# The Community Crier

March 7, 1979

The Newspaper with its Heart in the Plymouth-Canton Community

Vol. 6 No. 5 20¢

## Yack to run again, but not Gray

BY PATRICIA BARTOLD

With their terms as Plymouth-Canton Board of Education members expiring in June, Tom Yack will seek re-election for his seat, but Joe Gray has decided not to run.

Yack, who is currently the board president, said he will seek re-election because he enjoys the challenge of getting the board, school administration, and community to work together. "I like being where the action is," he said.

On the other hand, Joe Gray said he is declining a re-election bid because he wants someone else to devote time to the district. "Every year, we see fewer and fewer candidates running for the board and, to me, that's disappointing," he said.

Yack and Gray have served on the Board of Education since 1975. Both members were also appointed to the board for one-year terms previously. Gray was appointed to serve from July 1, 1973 to June 30, 1974 and Yack served from July 1, 1974 to June 30, 1975.

This year's election for the two seats on the Board of Education will be on June 11. The filing deadline for candidates is April 9 at 4 p.m.

To be a candidate, you must be: a registered voter who lives in the Plymouth-Canton school district; at least 18 years old; be a Michigan resident for at least 30 days; and, a citizen of the U.S.

Candidates need not be property

owners, said Florence Beier, from the district's community relations office. Furthermore, she said nominating petitions must have at least 54 qualified signatures.

She recommended candidates gather more than the required number of

signatures, since some petition signatures are usually invalid for various reasons.

April 12 is the last day to withdraw from the race, said Beier. For more information about board positions or if you are interested in becoming a candidate, contact Bernice Nichols at 453-0200, ext. 422.

## Will Canton get library?

BY CHAS CHILD

Canton voters may get a second chance to approve a one-mill levy to fund a library for the township.

Larry McEwen, vice chairman of the Canton Library Committee, asked the Board of Trustees last night to set a special election on May 15 to fund a library.

The board, however, tabled a decision on the matter until its May 13 meeting so it could further study the proposal.

"I'm for the library," said Trustee Robert Greenstein. "But the issue was just defeated by the voters (in the fall). We were just put on notice, and we don't have the moral right to slap the voters in the face by bringing it back before them."

McEwen replied that the voters

weren't familiar with the issue when they defeated it.

"We pay out of the general fund \$56,000 to the City of Plymouth's Dunning-Hough Library," McEwen said. "And by 1982, Canton will be paying an estimated \$116,000 - enough to pay for our own library."

Supervisor Noel Culbert added that "We're paying one-quarter of a mill now," referring to the \$56,000.

"We plan a strong education campaign if the election is approved," said Stan Bucher, chairman of the library committee. "The members of the committee will be available to speak at service groups, organizations, etc., and we will be passing out literature."

Next Tuesday's meeting starts at 7 p.m. at Township Hall, 1150 S. Canton Center Rd.

## New Heights beats deadline

BY W. EDWARD WENDOVER

Plymouth Heights is headed for its eighth time around.

Petitions calling for a new charter attempt in the defacto city (which includes all of Plymouth Township east of McClumpha Road) were filed with "Mayor" Tom Notebaert at 9:30 p.m. Monday - two and a half hours before the midnight deadline.

According to Notebaert, who will now file the petitions with the Wayne

County Clerk's office, some 329 signatures were submitted to him Monday evening. Three hundred signatures are required to be filed by midnight of the 10th day following certification of the last Plymouth Heights charter defeat to keep the measure alive.

(Actually, the tenth day from the Feb. 20 defeat of a Heights charter was Sunday but election laws grant an extra day in that case, said Plymouth Town-

Cont. on pg. 15

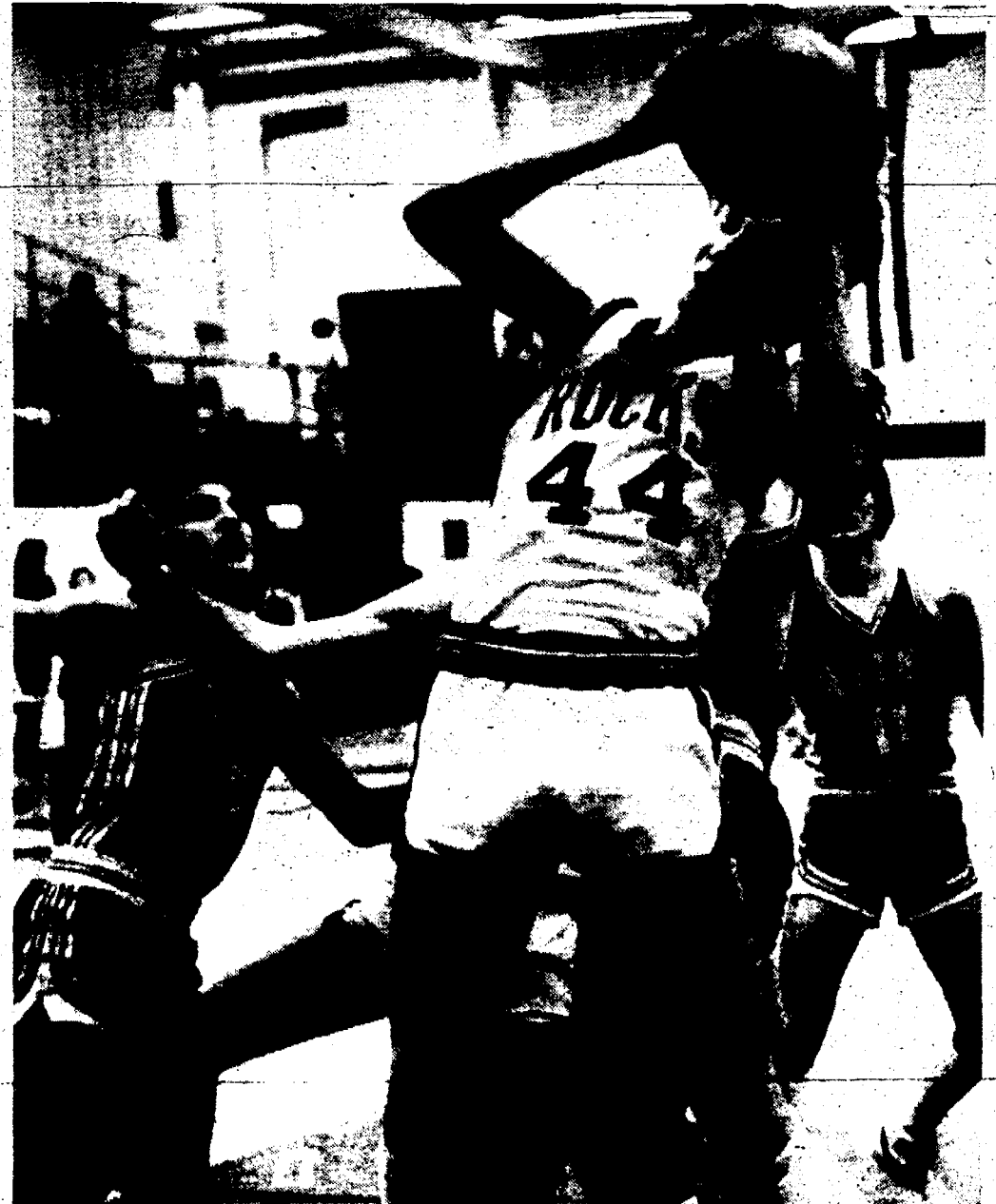

## Rocks win district game

ROCK CENTER Howard Monk pushes for a rebound in last night's 79-52 rout of Wayne Memorial in the opening round of district competition at home. The win raises Salem's record to 19-2 with Garden City East its next scheduled opponent tomorrow. Details of the Rocks' and Chiefs' upcoming district action start on page 19. (Crier photo by Bill Bresler.)

# Plot thickens State renews probe into Canton cemetery

A Canton cemetery which is fighting in court to avoid foreclosure on its undeveloped property also faces a renewed battle with the State of Michigan Cemetery Commission.

Knollwood Cemetery, located on

Ridge Road south of Ford Road, will be investigated by the state at a public hearing to be held at 11 a.m. March 29 in the Cemetery Commission offices in Lansing.

The state alleges that Knollwood is \$41,642 short in its endowed care trust fund and \$90,375 short in its merchandise trust fund. Those funds, according to state law, must be kept at a certain level tied to the sale of cemetery plots in advance of need.

Knollwood's license was revoked by the commission following a previous hearing on similar trust fund charges but the cemetery obtained an injunction from Wayne County Circuit Court blocking the revocation. The state attorney general has filed a motion seeking a summary judgment on the injunction but it has not yet been heard.

The cemetery is also fighting in Macomb County Circuit Court where a bank is seeking foreclosure on the undeveloped cemetery portions which were used as collateral on a loan to Knollwood owner Sam Tocco.

## New senior transit sought

Dissatisfied with the high price, Canton Supervisor Noel Culbert is looking for an alternative to the Nankin Transit Authority's transportation program for seniors and handicapped.

"We're not going to cut it off until we find something else," said Culbert. "But we are paying between \$12,000 and \$14,000 per year and the ride service only extends to Canton Center Road."

The authority charges the rider 50 cents per pick-up, and then bills the township \$6 for each ride.

"The Nankin system does not provide service 24 hours per day and you must call for a pick-up about two days in advance," said Culbert. "It's not very good."

The supervisor said he was investigating a taxi service for senior rides similar to Livonia's. "It would be 24-hour service and would only cost the township \$3 to \$4 per ride," he said.

## Buses roll from Canton to Detroit



Club gives beautification funds

THE PILGRIM GARDEN CLUB donated \$150 for the improvement and beautification of Miller Woods in Plymouth Township. Seen passing the check above are (from left to right): Diane Michaelson, Penny Wright, and Pat Robinson. Wright is the chairperson of the Miller Woods Committee and Michaelson and Robinson are members of the garden club. (Crier photo by Bill Bresler.)

A new SEMTA bus route from Canton Township to Detroit's Renaissance Center started Monday.

Leaving from the parking lot of Meijer Thrifty Acres, the buses will make six intermediate stops before the RenCen.

In the morning, the buses leave at 6:27, 6:52 and 7:17. They will

return from the RenCen at 4:37, 4:57, and 5:17.

"This is an added service," said SEMTA (Southeast Michigan Transportation Authority) spokesperson. "We have not taken anything away from the township."

One way fare is \$1.25, but 10-trip booklets and monthly passes are available that lower the per-trip price.

## S'craft offers levy info

A general information night for persons wishing details about Schoolcraft College's millage proposal has been set for Wednesday, March 7, at Schoolcraft College.

Co-chairmen Paul Y. Kadish and Harry G. Greenleaf will make brief presentations at 7:30 p.m. in Rooms B-200 and B-210 in the Liberal Arts Building. There will be a question and answer period.

Schoolcraft's request for a one-mill tax increase for five years is for capital expenditures. It will be voted at a special election on March 26.

## Canton sets deadlines to end board meetings

Canton's Board of Trustees will be under the gun to finish meetings by 11 p.m., according to a new policy adopted by the board last Tuesday.

Trustee Carol Bodenmiller, who proposed the deadline, said she was afraid fatigued trustees would make hasty decisions late at night.

"After going all day, you reach a saturation point," she said. A recent board meeting ended at 1:40 a.m. after starting, as they all do, at 7 p.m.

Under the rules, it will take a two-thirds vote of the board to extend meetings past 11 to 11:30. At this time, it would take another two-thirds vote to continue. If the board decides to stop, however, agenda items under discussion will be finished before adjournment.

Agenda items remaining at the cut-off will be tacked onto the beginning of the next scheduled meeting of the board in their same order.

Bodenmiller also proposed to schedule four meetings per month, but that was not considered by the board.

"We still have the option to call

special meetings to take care of extra business," she said. Presently, the board meets on the first, second, and fourth Tuesdays of the month at Township Hall, 1150 S. Canton Center Rd.

## Seniors to get discount cards

Discount cards for senior citizens from Plymouth Township and the City of Plymouth will be issued on March 30.

These identification cards, which are honored by about 60 local businesses, will entitle seniors to various discounts for services and merchandise.

Cards will be issued on March 30 at St. Kenneth Activities Hall, 14951 Haggerty Rd. from 10 a.m. to noon. This meeting is the second session of the senior discount program which is sponsored by the Plymouth Community Council on Aging.

Discount cards cost \$1 and seniors are asked to bring a social security card, driver's license, or some other identification card.

## St. Patrick's AN TOSTAL FESTIVAL

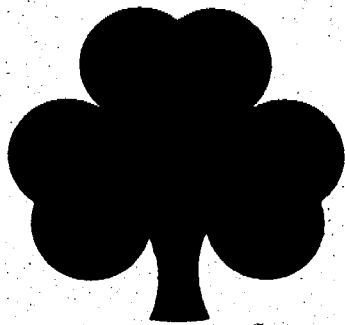

### MONDAY THROUGH SATURDAY FOOD FESTIVAL

This is a festival to remember, starting with an Irish noontime buffet served each weekday. And now you be ready for the Irish evenings with Special Butcher Blocks with Irish delights and all the trimmings.

### MONDAY THROUGH SATURDAY IRISH ELBOW BENDING.

What would St. Pat's Day be without Irish Harp beer on tap or Guinness Stout by the bottle? So we'll serve it up all week long just for you.

### SATURDAY, ST. PATRICK'S DAY IRISH BASH.

We'll set up an Irish pub in the ballroom, with good old Irish music of course. There'll be drinkin' and eatin' and an Irish jig or two. You can buy some Irish Whisky or sing an Irish tune. And at only \$3.00 per person entertainment charge, you can save a lot of green.

CALL FOR RESERVATIONS TODAY 459-4500

Plymouth  
Hilton  
Inn

5 Mile & Northville Roads  
Plymouth, Michigan 48170  
Call (313) 459-4500

# Strict building complaint law coming in Canton?

BY CHAS CHILD

Canton's Board of Trustees received some good news and some bad news Monday night about shoddy building practices in the township.

The good news is that a task force of builders assigned to handle complaints have finished 98 per cent of those on file, according to the chairman of the industry group, Dick Roeser of Beachum-Roeser Homes, Inc.

The bad news is that there is no guarantee for future homeowners that they, too, won't be victimized by uncompleted repairs, structural defects, etc.

However, township attorneys are preparing an ordinance that will require a performance bond on each house that the buyer can draw on if homes are not finished properly.

"I was totally amazed," said Supervisor Noel Culbert, referring to the performance of the builders' task force on making repairs. "I'm shocked that they did what was done."

A Canton resident asked, however, "What will assure that we won't be back in six months. Only when the fire burns down to their fingers that they do anything."

The meeting was called a month ago to assess the progress of the builders who had promised to answer all complaints on file in 30 days.

Although the board expressed satisfaction in the progress made thus far, another meeting was set for next month to review further complaints aired Monday evening and to discuss a proposed performance-bond ordinance.

About seven or eight persons said that their house still needed repairs, although most admitted that they weren't on the task force's list.

One resident, for example, said that

he had a list of 51 repairs that needed to be done. Another homeowner said that he had water backing up into his family room which had ruined his carpet.

Under fire from such complaints, builder Manny Dembs said, "I recommend the task force. We are dedicated and we have zeroed in on it. Our heart's in the right place and we'll follow through. We want to buy more lots in Canton."

Residents at the meeting seemed

to favor the proposal to require a performance bond on each house. According to Culbert, the plan looks like this: At some stage in the construction of the house, the builder would be required to post a bond, say \$5,000, with the township.

Then, if repairs weren't made within a certain period, the home buyer could use the money to finish his house.

However, Treasurer Jim Donahue said that the added cost of providing

bond would be incorporated into the price of the house and passed onto the buyer.

"If it costs us more, that's OK," said homeowner Tom Sullivan. "In the long run, it'll cost us a lot less headaches."

The meeting to review the performance of the builders' task force and the proposed bond ordinance was set for April 2, 7 p.m., at Township Hall, 1150 S. Canton Center Rd.



*Collapsed Canton canine revived*

WITH THE HELP of pure oxygen, Canton Township firefighter Jack Raker saved this dog overcome in a smoky blaze at 41582 Ford Road Thursday morning. The fire, spotted around 10:50 a.m., caused around \$20,000 damage to the home rented by Jeanne Gostomski, said Canton Fire Chief

Mel Paulun. Although the dog's real name is Sam, Paulun gave him an appropriate nickname: "Lucky." Gostomski was at work during the fire, which was under control in one-half hour, and no person was injured. (Crier photo by Chas Child.)

## City cops file for new union

Plymouth policemen appear headed towards a change in the union which represents them.

Five years ago the patrolmen and sergeants association switched from Police Officers Association of Michigan (POAM) to the Teamsters and now the 14-member union is switching back.

Union members have filed cards with the Michigan Employment Relations Commission (MERC) asking for representation by the POAM. A hearing on that request had been scheduled for Tuesday but was postponed.

If MERC finds the cards in order, it will schedule an election in which the policemen will choose which union they want to affiliate with, said Mike Gardner, union president.

Under terms of the contract which expires June 30, negotiations for a new contract must begin by April 1 — thus it is unclear whether the contemplated union change will delay that process.

City officials are keeping mum on the union jurisdictional fight. Acting City Manager John Zech said, "We have not a great deal to say about whether they go with Teamsters or POAM."

## Canton to mull sign size

A public meeting to discuss the size and placement of signs in Canton Township is set for Thursday, March 15 at 7 p.m., at Township Hall, 1150 S. Canton Center Rd.

Scheduled by the Board of Trustees, the hearing will consider the provisions

City critters?

You certainly wouldn't expect to find much wildlife in the City of Plymouth, but exactly that problem is plaguing residents of two areas in Plymouth.

Along Tonquish Creek rats infest the river banks, complained residents two weeks ago. On Monday night, City DPW Director Ken Vogras outlined a rat poison control program which will begin along the creek starting next week.

Near the C&O Railroad tracks, rodents and other animals inhabit walls and piles of rubbish, a Starkweather resident told the commission Monday.

"There're all kinds of animals in there," Linda England, of 877 Starkweather, said about the abandoned

of a proposed sign ordinance recently approved by the Planning Commission.

At Monday's board meeting, trustees saw a slide show prepared by ordinance officer Bruce Phillips which illustrated a number of high and low-profile signs in Canton and surrounding communities.

## City to poison Tonquish Creek rats

Golden Spike Restaurant area of the C&O tracks.

"I tried to get the railroad to clean it up and they won't," she said. "I'm concerned one of them may bite one of the kids."

England said her husband recently chased a possum out of their back yard with a stick.

Acting City Manager John Zech referred the complaint of animals on the C&O property to city departments.

## Creek cleanup planned

Sand bags, rat poison, chain link fence, rip-rapping, pumps and public information will all be used by the City of Plymouth's new "action plan" for combatting problems along Tonquish Creek.

The plan was discussed by the city commission Monday night in response to concerns expressed by creek area residents two weeks ago.

Included in the city's plan are:

\*Free sand and sand bags to creek area residents to help combat flooding. Area boy scout troops will help bag the sand for residents at the city DPW yard on Saturdays March 17, 24 and 31 from 9 a.m. to 5 p.m. (The yard is also open weekdays from 8 a.m. to 4:30 p.m.)

\*Rat poison being placed along the creek's banks starting March 15.

\*Chain link fence being installed along the north and south sides of Hartsough over the creek (between Coolidge and Fairground).

\*Rip-rapping, a form of erosion deterrent, being placed along city-owned creek banks by the Tonquish Creek Manor (not on private property).

\*Use of pumps after flooding occurs.

\*A complete plan detailing flood emergency procedures will be formulated and will appear in next week's Community Crier.



# Real Estate



BY  
**WILLIAM  
DECKER**  
REALTOR

## DISAPPEARING ACT

If you decide to help your Realtor show your home, do him, you, and the prospect a favor. Don't!

When prospects look at a home, they want to feel free to look around, walk here and there, and generally poke around. If they do buy, they'll be putting a lot of money in it, and they rightly want to make sure it's the home that's really for THEM. They don't feel free to really check the place if the owner is trailing along when the Realtor is showing them around.

This home may be the prospect's future "castle" — they'll want to inspect it carefully. They may walk around turning lights on and off to see if the lighting is adequate. Faucets in the kitchen and bathrooms may be tried, and such things as the oven, furnace, and water heater will be closely checked. The prospect would feel uneasy doing all these things under the watchful eyes of the owner!

So, if your Realtor calls up and says he has a prospect in tow, make plans to go to a show, do some shopping, or visit a friend. Remember, it's the HOME that's being sold and the spotlight should only be on it... not you!

.....

If there is anything we can do to help you in the field of real estate, please phone or drop in at REALTY WORLD, Wm. Decker, Inc. Realtors, 670 S. Main St. Plymouth. Phone: 455-8400. We're here to help!

# Freak stamps still sticky problem

BY CHAS CHILD

Rare stamps, like anything else, are only worth what you can get for them.

A number of persons in the Plymouth-Canton Community were sadly reminded of this when they learned that they weren't the only ones who had purchased funny-looking stamps at the Plymouth Post Office.

It seems the post office sold a lot more of the mis-cut stamps than the persons who discovered them realized. And what happens when a rare stamp isn't rare any more? Its value plummets.

Last week's Crier told the story of how a Canton dentist, Dr. Ronald Wisner, bought the stamps and didn't know they were potentially valuable until he sent a letter to an Ann Arbor stamp collector, Bob Gesell.

A member of the Plymouth-based West Suburban Stamp Club, Gesell informed Wisner that the stamps were valuable, and asked him if he would auction them to benefit research funds for muscular dystrophy. Wisner agreed.



But with the story out, it seems Wisner wasn't the only one with the odd stamps, which were sold in coils and perforated off-center.

"I received about five or six calls from people with the off-cut stamps," said Gesell.

Is the auction still on? "Yes," Gesell said. "They could still be valuable. It

depends on whether these stamps were sold just in Plymouth or all over the country. With the new automated equipment used by the post office in Washington to cut stamps, these kinds of freaks are becoming more possible."

Gesell took some of the odd stamps to a dealer in Toledo who was hesitant to buy them. There's a wait-and-see attitude, he said.

"I plan a similar trip to Cleveland, and we'll see," Gesell added. "It's a most interesting situation."

Meanwhile, Plymouth's postmaster, John Mulligan, said that he was surprised to see that any of the stamps had been sold. "We discovered them just after Christmas and I thought we got them all," he said. "Obviously we didn't."

Mulligan believes that only about 50 to 100 coils were sent to his station from Washington, D.C.

"I hope they get what they think they can for those stamps. I doubt if they're valuable," he said.

# Twp. studies open meeting policy

BY PHYLLIS REDFERN

Guidelines for special meetings and closed meetings were discussed at last Tuesday's Plymouth Township meeting.

According to the State of Michigan open meetings act, a closed meeting can be called by the board when an employer is discussing disciplinary action or employe relations, or for the purpose of buying real estate, or litigation.

The township policies requires that minutes be taken at all meetings, including the date, time, place, and members present. Decisions and votes must also be recorded. If a meeting is to be closed, reasons for it should be given.

Special meetings must be posted at least 18 hours in advance, after they have been cleared with the clerk's office. The township also requires that notification be given to all board members.

In the event of a closed meeting, minutes are kept on file in the clerk's office for a year and a day. Minutes from those meetings are not published or available to the public, said Township

Clerk Esther Hulsing.

One trustee said there should be an agenda for each meeting and the board should discuss only those items listed on the agenda. "I won't discuss anything that isn't on the agenda," said Township Trustee Lee Fidge. "We set the guidelines, now we must follow them," she

added.

Discussions can take place at closed meetings, but in order to vote or make a decision on something, the board must open the meeting. "I think we should delay voting until the next regular meeting," said Hulsing.

# City nixes Napoleon's entertainment license

For the second time in less than two years, the Plymouth City Commission has rejected a request from Napoleon's Restaurant for an entertainment license.

Voting 6-0, the commission Monday disapproved the request by Joseph Nabra of Napoleon's, located at 555 Forest. A similar request was denied on May 16, 1977.

The commission followed the recommendation of Plymouth Police Chief Timothy Ford who, like two years ago, said that granting an entertainment license could allow activities which may be felt harmful to the community. "We can grant an entertainment

license, but we have no vehicle to prohibit the license holder from modifying the entertainment in the future," Ford told the commission Monday.

Such a license could allow the restaurant to include topless dancing, Ford said, although that was not its intended use.

The chief said an entertainment license would be required to offer drinks for sale during a dinner theater or "gong show" act.

In addition to its Class C liquor license, Napoleon's currently holds a dance license which allows dancing by patrons.

# Licenseless theater ends

The curtain has come down on the dinner theater program at the Mayflower Meeting House.

Plymouth police have cited the Meeting House for violating its Class C liquor license by hosting the theater without holding an entertainment permit.

That action was revealed by Plymouth Police Chief Timothy Ford at Monday's Plymouth City Commission meeting during discussion of a request by another restaurant for an entertainment permit. Ford said he notified the Michigan

Liquor Control Commission (LCC) three weeks ago that the meeting house was offering the theater without a permit. Enforcement in such matters is handled by the LCC.

The chief also said he contacted Kirk Lorenz of the Mayflower who said he was unaware of the requirement for the entertainment permit.

Lorenz told The Crier he had applied for an entertainment license after being warned by the chief, but has cancelled his application and plans for future performances of the theater.



**MARCH SPECIAL**  
with this ad  
**15% OFF**  
carpet or furniture cleaning  
Carpet cleaning with our new truck mounted steam extractor

All work done by professionals  
Area rugs cleaned in our plant  
Complete line of New Carpeting from leading mills

**1175 STARKWEATHER**

**PLYMOUTH RUG CLEANERS INC.**

**453-7450**



COUPON GOOD THRU APRIL 29, 1979

**6 FREE VARIETY ROLLS at**  
**DAWN DONUTS.**

WHEN YOU BUY A DOZEN DONUTS OR ROLLS AT REG. PRICE

COUPON



Dawn Donuts of Plymouth  
Ann Arbor Rd. at I-275

Save 1/3

the Community  
**Crier**

Published each Wed. at 1226 S. Main St., Plymouth, Mich. 48170  
Carrier Delivered: \$8 per year. Mail Delivered: \$13 per year. Mailed at Controlled Circulation rates, Plymouth, Mich. 48170

# BOB'S FRUIT BARN

1082 S. Main Street Hours: Daily 10-7:30  
OPEN SUNDAY FOR YOUR CONVENIENCE 10:00 # 5:00

459-5960

California

**HEAD  
LETTUCE**  
59¢  
each



Vine Ripened

**TOMATOES**  
39¢  
lb.

**SEEDLESS  
GRAPES**  
88¢  
lb.

SNOW WHITE  
MUSHROOMS 99¢  
lb.

CELLO 88¢  
CARROTS 3 lb. bag

CELLO 3 FOR 99¢  
RADISHES

FRESH TENDER 99¢  
ASPARAGUS lb.

INTRODUCING THE NEW PITCHER PAC PLASTIC BAG-O-MILK

**HOMO MILK \$1.59**  
gal.

Plastic Bag - Save up to 40¢ gal.

**LO FAT MILK \$1.49**  
gal.

Plastic Bag - Save up to 30¢ gal.

## CHECK THESE DELI SPECIALS FROM BOB'S

BAKED HAM \$2.69  
lb.

HOFFMAN'S \$2.79  
HARD SALAMI lb.

REAL ROAST \$2.99  
TURKEY BREAST lb.

COLBY CHEESE \$1.99  
lb.

SHARP CHEDDAR \$1.99  
CHEESE lb.

HICKORY SMOKED \$1.69  
SLAB BACON lb.

ECKRICH \$1.79  
BOLOGNA lb.

ECKRICH \$2.99  
CORNER BEEF lb.

DANISH \$2.69  
HAVARTI lb.

WILSON'S  
**ICE CREAM**

All Flavors \$1.39 Save 20¢  
1/2 gal.

Florida  
**ORANGES**

99¢ 5 lb. bag



C-A Macintosh  
**APPLES**

3 lbs. 99¢

PASCAL 69¢  
CELERY

GREEN 19¢  
ONIONS

Fresh 59¢  
BROCCOLI

BRUSSEL 69¢  
SPROUTS

★ OPEN ★

★ 7 DAYS A WEEK FOR YOUR CONVENIENCE ★



## Local pride shines at March Madness

In the gymnasium of Plymouth Salem High School at tomorrow evening's district basketball tournament double-header, I hope to hear one of the loudest prolonged ovations of a lifetime.

It would be wonderful, as the clock approaches 7 p.m., if the hundreds of local cage followers present came to their feet spontaneously when Plymouth Canton's Western Six champions are introduced and gave Coach Craig Bell and his Chiefs the tribute they so richly deserve.

Having drawn a first-round bye, the Chiefs move automatically into Thursday's semi-finals. As this is written, it isn't known whether they will face Garden City West or Westland John Glenn, although that detail will appear elsewhere in these pages in the report of Monday's tourney action.

Identity of the foe isn't important. What is, is that a local populace let Bell and his kids know the community's pride in a team that marched unbeaten to the first league basketball championship in the young school's history and which finished the regular season 16-4 overall.

Win or lose from here on in, these boys - and that's what they are, not to be confused with the professional Pistons - for evermore will be able to hold their heads high as champions should. They did what was asked of them. Who can demand more?

If last night's tournament contest between Plymouth Salem and Wayne Memorial turned out the way you and I were hoping it would, then the second game Thursday will see Salem's Rocks taking on Garden City East in the other semi-final.

Under those conditions, the gym should be packed.

Salem deserves a standing, screaming ovation just as much as Canton, and hopefully it will come to pass.

This isn't just because Coach Fred Thomann's troops have won the school's sixth straight Suburban Eight title. Nor is it particularly for an 18-2 record going into the state tournament.

We're not cheering Charley Wolfe, Ron Egloff, Casey Jones, Eric Agardy, the Ellinghausen brothers and other stars of yesteryear this week. We're shouting from the rooftops that we understand what it is for a team to work



by  
Fred  
DeLano

its tails off, and that we understand the emotions of defeat as well as victory.

Champions deserve no less, whether they wear Blue and White, or Red and White.

Being a person of admitted prejudice, I'm hoping like the devil for an all-Plymouth championship final Saturday night

Chiefs vs. Rocks, Bell vs. Thomann.

Tense rivals, yes. But also friends. Schoolboy basketball can be as exciting as anything in the entire spectrum of sports, and Saturday's potential matchup would be one of the Plymouth-Canton Community's greatest moments.

If it turns out that way, meaning each would have to win Thursday, don't miss it. Remember, however, that regardless of which contender claims the district title there must be losers. Our school system still will be in the business of dispensing an education come Monday morning.

Now, a one-time word of explanation. Some of you may have blinked when you saw this by-line in The Community Crier.

It had been appearing in another Plymouth-Canton newspaper for just six weeks short of 12 years, but its appearance here today does not mean that April Fool's Day came early.

It only means that, for reasons of my own, I resigned from that organization, leaving many respected friends behind but rejoining another here in the person of Crier Publisher Ed Wendover, who took the same step several years ago. This weekly utterance will be varied and it will be local.

Isn't that what The Crier is all about?

## community opinions

### ESY cut hurts future

Huck Finn never would have made it in Plymouth-Canton. His fishing gear would have been stored in the shed while he was shackled into an ESY school during the long summer months.

There's still hope, however, for Huck Finn types since school administrators proposed to eliminate ESY at the middle school level next year.

But in the long run, elimination of ESY could prove more detrimental than helpful. Overcrowded conditions are a real issue in the Plymouth-Canton school district. Because of proposed boundary changes and the suggestion to eliminate ESY at Pioneer Middle School, parents and taxpayers are just coming to grips with this problem.

Over the next few years, the middle schools will have to absorb the largest number of additional students. ESY increases a school's capacity to house students by 33 per cent.

ESY works when scheduling required courses such as math, language arts, and reading. But elective courses pose a different set of problems. These scheduling problems plus others caused administrators to recommend ESY elimination.

In place of ESY, administrators are proposing ESD - the extended school day which could be adopted at the middle schools as early as 1980-81. ESD would extend a school's capacity by 20-25 per cent.

That would mean students on ESY this year would go to TSY next year and then ESD the following year.

What chaos!

Why not work the kinks out of ESY and keep it? That solution seems more sane, more sensible, and less disruptive.

The second issue at heart in the proposed changes concerns boundaries. Some school children have been forced to change schools and schedules more than once to accommodate the district's growth patterns.

Even if Pioneer retains ESY, 928 middle school students will be changed from one school to another to keep pace with growth. That's not a small number.

If such changes must be made, the Board of Education should try and make these changes equitable throughout the district. They should take into consideration the number of times each neighborhood has been moved from one school to another.

Stability, even though it's the antithesis of growth, should be one of the board's goals in considering boundary changes. Kids who have been changed from one school already should be allowed to remain where they are and not be moved again.

And, for the time being, it looks as though the Huck Finn tradition will just have to play hooky for the next few years.

PATRICIA BARTOLD

### Canton needs more than a 'buddy' for twp. attorney

When the firm of Sempliner, Thomas and Guth quit as Canton Township's attorney, the township Board of Trustees hired an old chum of Supervisor Noel Culbert on an interim basis.

It's time for the board to choose a permanent attorney for the township.

Although Jud Hemming, a law school buddy of Culbert, is undoubtedly a good lawyer, the township attorney should not have close personal links with the supervisor, who is in a position to push business his way.

When Hemming was hired (Nov. 28), the new board had just taken office and they needed an attorney quickly. Hemming was chosen on Culbert's recommendation, which, under the circumstances, was excusable.

Although Hemming is due for a

review in three months, more than enough time has passed already. The township board should start an impartial search for a permanent attorney immediately.

CHAS CHILD

### City acted well on CO

After The Crier found potentially hazardous levels of carbon monoxide in the Cultural Center's ice rink, Recreation Direction Chuck Skene took quick action to save skaters from possible harm.

Admitting there was a problem, he solved it with increased ventilation in the rink. He should be commended for his prompt and responsible service to the city and skaters.

THE COMMUNITY CRIER



Community

# The Crier

THE NEWSPAPER WITH ITS HEART IN THE  
PLYMOUTH-CANTON COMMUNITY

1226 S. Main St. Plymouth, Michigan 48170 (313) 453-6900

W. Edward Wendover, Publisher; Chas Child, Editor; Bill Bresler, Photo Editor; Patricia Bartold, Feature Editor; Mike Carne, Production Manager; Phyllis Redfern, Circulation and Office Director; Melanie Robinson, Business Manager; E. Dale Lee, Sports Editor; Patty Radzik, Asst. Sports Editor; Fran Hennings, Pat Steele, Judy Stewart, Robert S. Cameron, Advertising Consultants; Cynthia Trevino, Artist; Karen Sanchez, Typesetter; Judy Bode, Circulation Asst.



PUBLISHED EACH WEDNESDAY  
by Plymouth-Canton Community Crier, Inc.



Recycle Your Newspapers

Carrier Delivered: 70 cents monthly; \$8 yearly.  
Mail Delivered: \$13 yearly in U.S.A.

Member



W W WITH THE M M ALICE  
T T TOWARD N N ONE

By W. EDWARD WENDOVER



## What governmental form will Twp. try next?

What with all the Plymouth Heights, annexation, consolidation, and charter township talk, Plymouth Township must suffer from acute Governmental Schizophrenia.

What form of government will they try next?

Were monarchies allowed by Michigan law, someone in the township would no doubt organize a petition drive to implement it. And if a monarchy were protected from annexation or cityhood in another guise, it would be welcomed with open arms by the legions who want no taxes but complain loudly about lack of governmental services.

Now, the township officials are proposing a move towards township status once again.

The difference between now and Sept. 13, 1977, when township voters rejected charter status 839 to 243, is that such a move offers protection from annexation if certain conditions are met.

(The law was changed to offer charter townships immunity from city land grabs if police protection and garbage collection are provided by the township.)

This difference may sell charter status to the township voters. But don't count on it.

And that's just what township officials are doing.

In the last charter try, the township

board first passed a resolution calling for charter government without a vote of the people - a move which is still allowed by law.

Then, however, the board reconsidered and called a referendum on the topic.

Now the board is considering the change to charterdom by resolution - once again without a vote.

The stumbling block - which caused the board to reconsider last time around - is that a petition drive by townshipers to force a referendum on the matter is a virtual certainty. And if such a move is accomplished by the waving the flag that taxes will go up (a charter township may levy five mills as opposed to a general law township's one-mill maximum), charter status will surely be defeated.

Forseeing that, the township board should take the route of offering its constituents the choice. Put the matter on the next ballot.

It seems only fair that the voters be asked to give their opinions on something as major as changing their form of government. (The fact that the state law allows any other route for altering governmental structure is a travesty.)

Like it or not, the Plymouth Township board will get a referendum on charter status - it might as well take the positive approach.



**'TIS THE SEASON** for potholes, and they're popping up all over. Normally the roads in Plymouth and Canton townships are the worst, but the winter seems to have taken its toll on Main Street in Plymouth. This elephantine hole awaits the unwary driver in front of the The Crier offices. (Crier photo by Bill Bresler.)

## Goodby, Dolly!

If you were here for the 1974 Plymouth Schools' teacher strike, the name Dolly Carter McMaster probably rings a bell.

She was the PEA president who led the strike with fiery exchanges against "management," and lied to both her union constituents and the press.

Now, lo and behold.

Dolly is becoming management.

An Oakland County school district has hired her away from her teaching duties at West Middle School as an

## community opinions

assistant school principal.

As management, how will she fare with the teachers union there? It should prove interesting.

At least, we are happy to say, it's goodby, Dolly.

THE COMMUNITY CRIER

FROM CHUCK  
"THE BULL IN THE CHINA SHOP"

W  
H  
I  
T  
E  
H  
O  
R  
N  
E  
D  
B  
U  
L  
L



**We're on a Rampage!**

Join us Monday,  
March 12th for

**The Surprise!**

—as always—

**A Complete Selection  
of the Finest Traditional  
Home Accessories**

—including—

**A Complete Bath Boutique**

820 W. Ann Arbor Trail  
Phone 453-8310  
Open Mon-Sat 9:30-6 Friday til 9

# Plymouth and Canton students get Close-up view

BY LARRY BOLENBAUGH

In an effort to learn the ins and outs of democracy, 45 students from Salem and Canton high schools will get a peek at how government really works when they question their representatives about how they serve the public.

The students will be going to Washington, D.C., for a week from May 13 to 19 as part of the Close-up program, designed to introduce high school students to a first-hand view of government in action.

The close-up program has been incorporated into the curriculum for the civics class. Although there is a textbook for the class, the majority of class work involves guest speakers and an eventual trip to Washington, D.C.

"Students who were never interested in their studies undergo a dramatic change when they see the drama of government unfold in front of their

eyes," said Bill Gretzinger, one of the organizers of the program who is a civics teacher at Salem High.

The highlight of the class, when the students go to Washington, becomes the focal point for their study of federal government. They will meet their senators and congressmen and view them in action.

"The students actually help solicit money to help pay for their trip themselves. The Close-up Foundation offers one full fellowship per school and the rest of the money must be raised separately, Gretzinger said.

"We actually write letters ourselves to companies appealing for financial aid for our trip," said Kelly Hubert, one of the students who will go to Washington.

The trip is not just a sightseeing trip. The students who participate must adhere to schedule of events all week long while in Washington. They will get up before 7 a.m. and attend workshops and briefings all day long until past 10 p.m., Gretzinger said.

"For all the workshops and seminars, we have to write critiques on the speakers and fully participate in the program," Hubert said.

The Close-up Foundation has been in operation since 1970. It was established by public law and is a private founda-

tion, although corporate grants are matched by federal grants.

In order to be able to go, the group must raise over \$18,000 in addition to two fellowships they get, one for Salem and one for Canton.

"We would like to make as many people aware of the Close-up program as possible," said Bob Thams, the other teacher-sponsor of the program. "We feel this is a very worthwhile program

and if more people were aware of it, more would take advantage of it."

Any students who signs up for Civics 2-Close-up, the course affiliated with the program, is eligible to go on the trip, Gretzinger said.

In addition to the schedule of events in Washington that the students must attend, they also get some free time to ride the metro-bus through town. They must be back by 7 p.m.

**THE PLYMOUTH COMMUNITY COUNCIL ON AGING ANNOUNCES THE OPENING OF IT'S NEW OFFICE AT 185 S. HARVEY 459-4907 P.O. Box 613 Hours: 10-2 Mon. - Thurs. CLIP & SAVE FOR REFERENCE**

**A world of Books for Young and Old**

Open 10 to 9 Mon. - Sat. 10 to 5 Sunday

**LITTLE PROFESSOR BOOK CENTER**

1488 SHELTON ROAD at Ann Arbor Road Plymouth 48170

## Jobs found for skilled students

Jobs for students with particular skills were found for 427 students at Salem and Canton high schools during 1978.

The yearly report for the Job Placement Office at the Centennial Educational Park was released to the Plymouth-Canton Board of Education last Monday night. Placements were made for 427 students compared to 301 placements in 1977.

The number of job openings also rose with 327 openings in 1977 to 398 in 1978.

These findings were released by Joyce Willis, job placement specialist.

## Plymouth High looks for 10-year alumni

The Plymouth High School Class of 1969 is planning a 10-Year Reunion for June 30, 1979, and more than 100 alumni that have not yet been located.

Reservations are being taken now through April 15 which is the deadline for money to be submitted for tickets.

For more information, classmates may call Karry (Eckles) Lancaster at 455-4268 or write the Reunion Committee at 8854 Corrine, Plymouth, Mi. 48170.



**MANY HANDS MAKE LIGHT WORK.** A power blackout affected the Old Village section of Plymouth on Thursday at about 12:20 p.m. Three traffic lights stopped working; however no major accidents were reported as Plymouth police officers like Mike Gardner, seen above, hand-directed drivers through intersections. According to Lt. Charles Groth of the Plymouth firefighters, apparently a transformer exploded at 198 W. Liberty St. in Old Village.

## Business woman beats Feds

BY CHAS CHILD

After nine months, at least 20 different forms filled out, dozens of long-distance phone calls, and hours of aggravation, Mary Lee Hosey finally oiled the squeaky gears of the U.S. federal bureaucracy.

On Thursday her persistence was rewarded by a Small Business Administration loan for her firm, The Health Shoppe in downtown Plymouth, that was damaged by a flood last year.

"It was unreal what I had to go through," said Hosey. "The SBA had to authorize the authorizations of the authorizations."

In the basement of the Penniman Avenue Shops, her business was in-

undated with 17 inches of water on May 31, in "The Great Flood of 1978." The SBA set up a temporary office in the city to handle the applications for low-cost loans, and many firms applied.

However, this was only the first step through a frustrating jungle of red tape, said Hosey. "I must have filled out about 20 different forms in about seven months. They wanted all kinds of records, including a photostat of my lease. They wanted everything but my dental records, it seemed."

And, according to Hosey, she was the only original applicant to stick it out and get one of the hardship loans. "Everyone else dropped out," she said.

**THE MAYFLOWER Optical Shoppe**

Soft Lenses \$125<sup>00</sup>

Hard Lenses \$100<sup>00</sup> Complete

The finest selection in eyewear featuring

1488 SHELTON ROAD at Ann Arbor Road Plymouth 48170

455-0210

**DAVE'S CARPET SERVICE**

**SPRING HOUSECLEANING**

Let US do your work for you

Carpets & Upholstery

**SALE on new CARPETS TOO!**

- 14' Sq. ft. (reg. 16')
- 12x15 living rm., 3x10 hall (210 sq. ft.) \$29<sup>95</sup>
- Couch \$25<sup>95</sup> Reg. \$35.50 Velvet Extra

PRICES GOOD THRU MARCH

640 Starkweather • Call for FREE Estimate • 459-3090



## Parents speak their piece on boundaries

BY PATRICIA BARTOLD

Parents aired their gripes about proposed boundary changes and the elimination or extension of the extended school year (ESY) to the Plymouth-Canton Board of Education last night.

Included in the public forum was a group of 20-30 teachers from Pioneer Middle School who support the proposal to change Pioneer from ESY to a traditional school year calendar (TSY).

The public forum culminated a series of small parent groups which have met throughout the district over the past week.

On Wednesday evening, about 20 parents from southern Canton gathered at Eriksson Elementary School to object to proposed boundary changes which result in transferring their children from one school to another. They met with Board of Education members Carol Davis and Steve Harper.

On Friday night, the same group, which is called the Citizens Organized for Action (COFA), met with Board President Tom Yack. COFA members have passed a petition stating their objections to proposed changes through-

out Canton. By Monday, 747 citizens and parents had signed the petition.

On Thursday night, another group of about 60 parents from Windsor Park in Canton met at Hulsing Elementary School. They drafted a letter to the Board of Education objecting to the proposal to adopt ESY at Hulsing and other proposed boundary changes.

Both COFA members and the parents from Windsor Park objected to the number of times their kids had been forced to change schools because of boundary changes.

Jo Wallace, spokesperson of the Windsor Park parents, said, "Some of the kids have been forced to move from one school to another four times over the past six years."

Meanwhile COFA parents, headed by Darleen Protulis, asked the board to grant immunity to kids from her neighborhood in making more boundary changes. "Middle school kids were changed from West to Pioneer. Now district officials are asking our kids to move to East or Central middle schools," said Protulis, adding that the changes have occurred during the past five years.

Both groups of parents said their kids suffer negative psychological effects from changing schools so often.

Furthermore, Wallace said, "It's very unfair to make our kids move again when others in the district haven't moved at all." Protulis said school transfers should be evenly distributed throughout the district.

Asked if COFA parents were proposing to switch school districts from Plymouth-Canton to Westland or Livonia, Protulis said, "No, we pay our taxes here and this is where our kids will go to school." COFA parents represent citizens from Camelot West, Westbrook,

Cavalier South, Cavalier North and Parkwood subdivisions.

About 20-30 teachers from Pioneer Middle School were expected to attend last night's public forum. They were lead by spokesperson Ernest Bevins, a learning specialist from Pioneer.

Pioneer teachers want ESY eliminated there. "ESY destroys the continuity of a program," he said. For example, he said some students on Track B miss his teaching for six weeks when some students are off-track for three weeks and then he is off-track for three weeks. "I must reteach lessons since students are off-track every three weeks," he said.

Furthermore, he said elective classes at Pioneer have suffered drastically under ESY. "Gym, music, home living and industrial arts classes suffer the most," he said. For example, when the home living teacher has two-thirds of her class ready to cook, one-third of the class comes in from vacation and they don't know the safety rules in the kitchen, he said.

A survey of Pioneer teachers showed 36 teachers wanted to drop ESY, but six teachers wanted to retain ESY and six teachers had no preference, said Bevins.

President Tom Yack closed the public forum by saying the Board of Education will talk about proposed changes and alternatives at its next meeting on Monday, March 12. The meeting will start at 7:30 p.m. at 454 S. Harvey St.

Yack added that board members may meet in an informal workshop before Monday to talk about the gripes aired and possible solutions. Notice of the workshop will be posted in advance at the school district offices, he said.



AS PART OF HIS portrayal of Canton history, Charles Zazula will use the Time Capsule Edition of The Community Crier which was published in July, 1976. Zazula will speak at the Plymouth Historical Museum on Thursday, March 8 at 7:30 p.m. (Crier photo by Bill Bresler.)

## Canton's birthday saluted by portrayal of local history

If you think the battle of Harvard Square takes place at local shopping center, let Charles Zazula tell you about the real Battle of Harvard Square.

This historical confrontation will be included in his portrayal of Canton history on March 8 at the Plymouth Historical Museum. His talk will begin at 7:30 p.m.

Zazula's speech marks the 145th anniversary of Canton Township. It was on March 7, 1834 that South Town No. 2 of Plymouth Township became Canton Township.

Zazula gathered information about Canton history by interviewing the families of early descendents and his

account adds up to about 70 pages of local history.

On Thursday night, Zazula's speech will include: maps dating back to 1818 and 1876; the names of early settlers and their accomplishments; early school records and photos; earliest settlements and landmarks; how and when Canton got its name; Cantonites as prominent Plymouthites; the mystery of the two Kelloggs; and, the Battle of Harvard Square.

Zazula became interested in Canton history after serving as historical researcher on the Plymouth Community and Canton Bicentennial Commissions in 1975-76.

## Next Twp. trustees meeting to be held in new surroundings

BY PHYLLIS REDFERN

If all goes as planned, the next regularly scheduled Plymouth Township Board of Trustees meeting on March 13 will be held in the new meeting room, in the Teledyne Building.

The present township hall and the next-door Teledyne building will soon be renovated and become a new, much larger township hall.

At last Tuesday's meeting, the township board approved the plans and specifications for the new building and authorized the architect Michael Boggio to go out for bids. Boggio said drawings of the plans and specifications would be available March 1 at his office and township hall.

"Everything is moving along as scheduled," said Boggio. He added that the deadline for accepting the bids on the con-

struction is March 24.

Once the bids are in, the township board will award the contract, and remodeling construction will begin.

Site analysis of Township Hall will be presented by Michale Bailey, township engineer, at the March 13 board meeting. That meeting will begin at 7:30 (a half hour earlier than the regularly scheduled meetings) to allow the trustees more time to examine and ask questions about the site plans.

Construction will take place through the spring and summer. Township offices will remain open during the remodeling. "I really don't see how we're going to manage working in the mess," said Township Clerk Esther Hulsing. She said the architect told them the work would be done in sections so as not to interfere with township business.



746 STARKWEATHER

459-5444



Coupon GOOD THRU APRIL 29, 1979

**VARIETY ROLLS at**

**DAWN DONUTS.**

Baked fresh daily by professional bakers.

ONLY **15¢** LIMIT

2 DOZEN

TAKE OUT ONLY

This coupon cannot be used with any other coupon

COUPON

# COPIES MADE

Mondays - Fridays: 9 am to 5 pm

## 1226 S. Main St.

## Plymouth



SHARON BELOBRAIDICH



JOAN GERIGK



FRAN LANG



DEE MARTIN



ELICE MURPHY

# Who'll be king, queen of 'Way Off Broadway'?

BY PATRICIA BARTOLD

Can you sing, tap dance, or even perform a series of non-stop cart wheels? Auditions for the upcoming production of "Way Off Broadway" are Wednesday, March 7, at Pioneer Middle School. They'll start at 8 p.m.

"You don't have to be a singer or dancer to join," said Dotty Magee, chairperson of the 1979 Follies sponsored by the Plymouth Community Arts Council. "After two weeks of practice, you'll be a pro," she added.

The candidates for the stately positions of king and queen were also announced last week. The candidates for king are: L. John Miller, Gary Balconi, Chuck Avis, Larry Kennedy, and Father Bob Keller. The queen candidates are: Sharon Belobraidich, Fran Lang, Dee Martin, Joan Gerigk, and Elice Murphy.

The winners of the "King and Who" contest will be named during the final performance of the 1979 Follies on March 24. "Way Off Broadway" will

open on March 23 and both performances will be at the Salem High School Auditorium. Curtain time is 8:30 p.m.

On Tuesday night, about 125 prospective cast members were expected to meet the director at Pioneer Middle School. He is Charlie Crain from Jerome H. Cargill Producing Organization in New York. Crain will be in charge of directing and producing a show from Plymouth-Canton talent.

Tickets for the follies can be bought from any cast member or at the Plymouth Community Arts Council Office,

friends & neighbors

332 S. Main St., Plymouth.

Tickets range from \$3-\$6 per person. During the week of March 19 to March 23, tickets can be exchanged at the Edison Box Office from 9 a.m. to 5 p.m. for reserved seat tickets.

Proceeds from the follies are used to fund PCAC scholarships, finance art programs in the elementary and middle schools, to continue guest theater performances in the school district, and, for various other non-profit programs.



CHUCK AVIS



GARY BALCONI



FATHER BOB KELLER



LARRY KENNEDY



L. JOHN MILLER



## Your Guide to Local Churches Come Worship With Us

### The Colony Bible Fellowship

(The Wesleyan Church)  
42290 Five Mile Road  
Plymouth  
420-0484 or 420-2898  
Gary A. Curell, Pastor

Sunday School 10 a.m.  
Worship Celebration 11 a.m.  
Gospel Inspirations 6:30 p.m.

### Calvary Baptist Church

43065 Joy Road  
Canton  
453-6749 or 455-0022  
Dr. G. Douglas Routledge

Bible School & Worship  
9:45 & 11 a.m.  
Evening Evangel. 6 p.m.

### Dixboro United Methodist

5221 Church Rd.  
Corner of Ann Arbor Rd.  
& Cherry Hill  
665-5632

Rev. Hal Ferris 662-3645  
Church School 9:30;  
Worship 10:45; Coffee 11:45

### Lutheran Church of the Risen Christ

Missouri Synod  
46250 W. Ann Arbor Rd.  
1 Mile West of Sheldon  
453-5252  
Rev. Kenneth E. Zietke

Sunday Services 9:00 & 10:45  
Sunday School 9:00 a.m.

### Central Baptist Temple

670 Church St.  
455-7711 or  
455-HELP  
Dr. Stan Jenkins, Pastor

Sunday School 10 a.m.  
Sunday Services 11 a.m. & 6 p.m.  
Wed. Bible Study 7 p.m.  
Active Youth, Bus Ministry

### The Salvation Army

290 Fairground  
Plymouth  
453-5464  
Lt. Bill Harfoot

Sunday School 9:45 a.m.  
Morning Worship 11:00 a.m.  
Evening Worship 6:00 p.m.

### People's Church

Worshipping at Plymouth  
Canton High School  
8415 Canton Center Road  
Canton, Michigan  
981-0499  
Rev. Harvey Heneveld, Pastor

Morning Worship 10 a.m.  
Fellowship Hour and Sunday  
School following

### Plymouth Church of the Nazarene

41550 E. Ann Arbor Tr.  
453-1525  
Carl R. Allen, Pastor

Sunday School 9:45 a.m.  
Sunday Services 11 a.m. & 6 p.m.  
Midweek Service (Wed.) 7 p.m.

### Faith Community Church

Meeting in Pioneer  
Middle School  
46081 Ann Arbor Rd.  
Rev. Darryl Bell  
459-2199

Sunday School 9:15 a.m.  
Family Worship 10:30 a.m.

### First Church of Christ Scientist

1100 W. Ann Arbor Tr.  
Church & Reading Room  
453-1676

Church & Sunday School  
10:30 - 11:30 a.m.  
Wed. Church 8-9 p.m.

Reading Room  
In Forest Place Mall  
All Are Most Welcome

### First United Methodist Church

45201 N. Territorial  
453-5280  
Samuel F. Stout  
Frank Lyman, Jr.  
F.C. Vosburg

9:30 & 11:00 Worship & Church School

### Landmark Baptist Church

Fundamental Missionary  
Prominental  
11095 Haggerty Rd.  
betw. Ann Arbor Rd.  
& Ann Arbor Tr.  
Plymouth  
453-9132  
Rev. James R. Dillon

Sunday School 10 a.m.  
Evangelistic Serv. 11 a.m.  
Even. Evang. Serv. 7 p.m.  
Wed. Bible Study 7 p.m.

### Tri City Assembly of God

2100 Hennen Rd.  
N. of Michigan Ave.  
721-6832  
Rev. E.W. Reimer

Morning Worship Serv. 11 a.m.  
Ministry to the Deaf  
Sunday School 9:00 a.m.  
Evangelistic Services 7 p.m.

# tell it to Phyllis



The first signs of spring are here at last. Car windows are down and car radios are turned up full blast, and there's a line three blocks long at the car wash. I love the feeling of driving out of the car wash with my sparkling clean car, when along comes some jerk and splashes mud all over it before I even have a chance to pull out onto the street.

Remember not to get taken in too much by this first heat wave. We're due for at least one more blast of snow and cold weather. Even I look dumb trying to jump rope and ride my bike in two feet of snow.

With thoughts of spring and trying to squeeze into last year's fashions, I'm suddenly reminded that I've missed two weeks of my favorite exercise class. It's impossible to forget when you receive a letter from the drill sergeant herself. If any of you thought I've been exaggerating about the class, read this:

Dear Phyllis,

Since there were no "echoing claps" tonight, I could only assume you weren't here! Sure enough, even the eyes in the back of my head didn't find you. Due to your absence, "Ruby" did not make her scheduled appearance - rather she will wait for your return. (Ruby is an exercise routine that requires a great deal of coordination as well as stamina, and you're sure you're going to have a heart attack before you get half way through it.)

In the meantime, your homework is as follows: six stretches, four stretch and bends, "Raindrops" - Don't quit on the killer!!, 35 situps (knees bent, remember!), leg raises (10 on each side), and Ruby - just to get you psyched up for next week.

Should this not be enough of a work-out for you, please call - or better yet, jog and jump rope to my house and I'll give you some other of "Lynne's Lovelies that require Lots of Luck!"

See you next week,  
Lynne

Now, I ask you does that sound more like a persuader or drill sergeant? I hope I have enough nerve or whatever it takes to make it to the next class. Actually all it takes is a look at those spring clothes hanging in the closet.

\*\*\*\*\*

Fashion Reflections 1979 was presented last week by Plymouth Newcomers at their annual fashion show and luncheon. Club members learned about the latest in spring fashion designs and hair styles presented by Claire Kelly, The House of Glamour, Famous Men's Wear, Mel's Golden Razor, and The Little Angels Shoppe.

Modeling the women's fashions were Joanne Berg, Pam Briggs, Debby Johnson, Alda Jean Lusk, Lynda Moore, Kay Rehm, Mary Schauer, and Fab Snage. Men's fashions were worn by Ed Davis and Bob Mero, Traci Breniser, Jacey Wenckus, Phillip Davis, and Kevin Fielman modeled the childrens clothes.

The fashion show was coordinated by Linda Anderson, Janet English, and Barbara Secord. Marcelline Nowicki designed the program cover, Mona Kolacki designed the name tags, Sheridan Brown was in charge of publicity, and Kathy Conroy was in charge of making reservations. Working on ticket sales were Dottie Derhake, Peg Johnson, Carolyn Stevens, Carol Wright, and Mary Yarlotte. Pat Breniser was in charge of the door prizes.

## Toddlers can go to school

Registration for the September session of the Willow Creek Co-op Nursery is starting now. The nursery classes are held at the Geneva United Presbyterian Church at 5835 Sheldon Rd.

Classes for three-year-olds meet Tuesdays from 9:30 to 11:45 a.m. for a one-day session or Wednesdays and Fridays from 9:30 to 11:45 a.m. for a two-day session.

Four-year-olds can come to one of three two-day sessions. They are: Monday and Thursdays from 9:30 to 11:45

a.m.; Mondays and Wednesdays from 12:45 to 3 p.m.; and, Tuesdays and Thursdays from 12:45 to 3 p.m.

An optional-third-day program is also offered for four-year-olds on Fridays from 12:45 to 3 p.m.

To acquaint parents with the nursery school, parents are invited to the May Round-Up on May 17 from 9:30 to 11 a.m.

For more information about the co-op nursery or to register your child, call Karen Cifrodella at 981-0264.

## Anne and Van make nuptial plans



ANNE HEINDRYCKX

Mr. and Mrs. Albert Heindryckx of Plymouth announce the engagement of their daughter, Anne, to Van V. Varner, son of Mr. and Mrs. Lawrence Varner of Merrill.

The bride-elect is a 1970 graduate of Plymouth High School. She earned her bachelor of science degree in 1975 from Michigan State University where she is employed as an undergraduate advisor in the Crop and Soil Science Department.

Her fiance graduated from Breckenridge High School. He earned his bachelor of science degree from Michigan State University in 1975. He is working on his masters degree at MSU and is employed by the cooperative extension service as a Huron County agricultural agent.

They plan a May wedding in First United Methodist Church of Plymouth.



# BUSY BEE CRAFTS

455-8560

42320 Ann Arbor Rd.

COME SEE US AT OUR NEW LOCATION  
ON ANN ARBOR ROAD EAST OF LILLEY

### ★ Broomcorn Basket Class

Sat., May 19th...1 session...1-3:30 pm.  
\$5 incl. materials

### ★ Macrame & Basket Weaving

Mon., March 26th...1-3 pm & 7-9 pm...Mrs Kabel  
Tues., March 27th...1-3 pm & 7-9 pm...Mrs. Ohno  
\$22.50...Supplies included

### ★ Crewel

Tues., March 27th...7-9 pm...\$10 plus supplies...4 weeks

### ★ Pillow Weaving Class

April 4th...7-9 pm & April 10th 1-3 pm...\$10 incl. Supplies

..... ATTENTION .....  
Stained Glass Class...Tues. April 27th ...7-9 pm  
Caning...make a stool in one session...Call for Details



# 1/2 Done Club

Bring in your partially complete projects (and a sack lunch) -- We'll put the coffee on! This is a free, informal work session -- NOT a class. Helpful advice available, but not extensive instruction. No children, please. Feel free to come for any part of the time. Stop in even for a few minutes on your lunch hour!

## WANTED: INSTRUCTORS

for NEW and unusual craft classes.  
Call for an appointment with Helen.

## DON'T BE SCARED

by our new, large, Craft Supermarket appearance. We still maintain our Small Shop personalized service when you need it! You know us -- we know you! All our salespeople do crafts...we insist on it!

NEW LOCATION

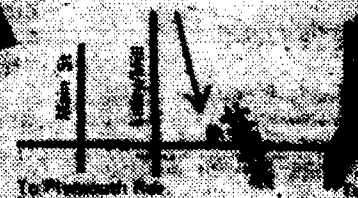



# Fluidity graced the harpist

BY P.D. MORSE

There was a lot of pluck to Sunday's Plymouth Symphony Orchestra concert featuring guest harpist Maria Royce.

The harp, which provided variety and excitement, is not a frequently featured symphony instrument. Coupled to good performances by the orchestra, it resulted in a very rewarding afternoon of fine music.

Royce, of Grand Rapids, played the harp for two selections, Handel's Concert for Harp and Orchestra, and Debussy's Dances for Chromatic Harp and Strings. Both pieces chiefly used the string sections of the orchestra which complemented the beauty and range of the harp.

An accomplished harpist, Royce played with strength and fluidity. Several passages in her music were quite difficult but she played these without pause or strain. The orchestra also provided balance to accentuate Royce's performance.

It was an excellent performance by both soloist and orchestra.

The full symphony orchestra played two additional pieces, Symphony No. 1 in E Minor by Sibelius and Symphonic Metamorphosis of Themes of Carl Maria von Weber by Hindemith. The Sibelius symphony was played with energy and enthusiasm. The orchestra held together for this piece better than for any other piece of similar difficulty this year.

The complex violin passages were less indistinct than they had been in the past. The addition of several players to the first violin section seems to have helped solve this problem. The violin sections were also better synchronized for this piece, as evidenced by the clarity of the final plucked cords played by both violin sections.

The Hindemith Symphony, however, started out weakly. When the second violins played the theme, it was barely recognizable or audible. The added strength of the first violins clearly did not carry over into the second violin section. However, this performance improved through the second and third movements.

This selection required considerable activity of the percussionists; the xylophone, chimes, cymbals, and snare drum, were used frequently. This section of the orchestra had additional players as well.

Both symphonies gave the orchestra a considerable workout and the members were clearly exhausted after the performance was over. The results, however, were worth it.

## Musicmakers win

The Plymouth Youth Symphony will present a concerto concert on March 13 at the Canton High School Little Theater at 8 p.m.

Three string players and two wind players will receive scholarships from the Plymouth Symphony and the Woman's Club of Plymouth. The scholarship winners are: Jesse Seary, Lora Kramer, John Perrett, Darch Johnson, and Cheri Bertrand.

The concert will include works by Telemann, Dvorak, Vivaldi, and Beethoven. The musical director and principal conductor of the Youth Symphony is Robert G. Burr of Plymouth.

Vicki Vorreiter is the Associate Musical Director.

## Tutor reading, math

Volunteer tutors are needed to help middle and elementary school students in reading and math. The tutoring program is offered by Our House Crisis and Counseling Center in Plymouth.

Persons are needed to help kids learn seventh and eighth grade math and elementary reading, said Laura Upton, program coordinator.

Tutors meet with students on a one-to-one basis, she said. For more information, call Upton at 455-4902.

## Kindergarten sign-up

Miller Elementary School, 43721 Hanford Rd., Canton, will have kindergarten registration for the school year 1979-80 on Wednesday, April 4, 1979 from 9-11 a.m. and 1-3 p.m.

Please bring with you the birth certificate or baptismal record which we must verify.

Any child who will be five years old on or before Dec. 1, 1979 will be eligible to attend the 1979-80 kindergarten.

# what's happening

## PLYMOUTH BRANCH FARM AND GARDEN

The Plymouth Branch of the Woman's National Farm and Garden Association will meet on March 12 at noon at the Plymouth Historical Museum. Members may invite guests.

## CANTON NEWCOMERS

Members of the Canton Newcomers will meet on March 7 at Pioneer Middle School. Hospitality begins at 7 p.m.

## CHILDBIRTH PREPARATION CLASSES

Childbirth preparation classes for expectant couples are being offered by Childbirth and Family Resource Center Ltd., 865 Penniman, Plymouth. Drop in or call from 10 a.m. to 3 p.m. weekdays (except Tuesday) or Saturdays 10 a.m. to noon at 459-2360.

## EASTER ARTS & CRAFTS SHOW

Applications are now being accepted for the Plymouth Recreation Department's second annual Easter Arts & Crafts Show. The show will take place the weekend of March 30, 31 and April 1 at the Plymouth Cultural Center. Hours are Friday from 11 a.m. to 9 p.m., Saturday from 11 a.m. to 7 p.m. and Sunday from 11 a.m. to 5 p.m. Interested exhibitors can register in person, from 8:30 a.m. to 5 p.m. Monday thru Friday at 525 Farmer Street.

## WAYNE COUNTY NUTRITION PROGRAM

The City of Plymouth, in cooperation with the Wayne County Office on Aging, offers a nutrition program Monday through Friday, at Tonquish Creek Manor, 1160 Sheridan. The nutrition program offers seniors a well-balanced meal at the site, or by calling 455-6620 from 8:30 a.m. to 5 p.m. All reservations must be made by Thursday of the preceding week. The program is free, however, a 50 cent donation is appreciated.

## SPRING HOCKEY LEAGUE

The Plymouth Recreation Department is now taking registrations for a spring hockey league. Fee is \$64 per team which covers officials, trophies and ice time for the last two games. Registration deadline is Friday, March 9, games begin March 26. Guarantee of 14 games. Contact Al Campbell at 459-6444 for further information.

## CHESS CLUB

The Chess Club meets every Tuesday evening from 7:30-10:30 p.m. at the Cultural Center. Novice to advanced players are invited to attend. Free instruction provided to beginners. For more information contact Doug Ladney at 453-6748.

## PAINT FOR FUN

Paint for fun meets each Thursday from 1-3:30 p.m. at the Cultural Center. No fee. For further information contact Fred Prussing at 455-8894.

## DUPLICATE BRIDGE

Duplicate Bridge will meet every Tuesday evening at 7:30 p.m. and on Wednesday afternoons from 11 a.m. to 3 p.m. at the Cultural Center. Novice to advanced are welcome.

## OIL PAINTING

For those who have experience in painting with oil, informal sessions will be meeting at the Cultural Center on Monday from 10 a.m. to 1 p.m.

## COMMUNITY CHORUS

Community Chorus, men's and women's choral group meets Tuesday at 8 p.m. in the vocal room at East Middle School, 1042 S. Mill.

## PARTY BRIDGE

Party Bridge takes place at the Cultural Center on Thursday from 1-4 p.m.

## TUESDAY NIGHT SINGLES

The Tuesday Night Singles will meet at the American Legion Hall, Main Street, Ann Arbor, on March 13. Dancing will start at 8:30 p.m.

## ST. PATRICK'S PARTY

Everyone is invited to the fifth annual St. Patrick's Day Party, Saturday, March 17 at the Knights of Columbus Hall, 150 Fair St., Plymouth. Tickets for \$19.50 per couple include dinner and beer. Dancing begins at 8:30 p.m. For tickets call 453-9724.

## ST. PATRICK'S DAY DANCE

Mayflower Post No. 6695 VFW will hold its annual St. Patrick's Day Dance on Saturday, March 17, 8 p.m. at the Post Hall, 1426 S. Mill Street, Plymouth. Buffet refreshments will be served during the evening. Free beer will be provided and set-ups for a BYOB arrangement. The public is invited and the cost is \$15 a couple. Further information and tickets may be obtained by calling Al Heindryckx at 455-2864.

# community births

## It's Thomas

Thomas Jarred Hindman was born on Feb. 21. He is the first child of Mr. and Mrs. Thomas Hindman of Plymouth and weighed seven pounds, 15 ounces.

Maternal grandparents are Mr. and Mrs. Richard Massengill, Sr. of Plymouth. Paternal grandparents are Mrs. Angeline Hindman of Plymouth and Dr. Robert Hindman of Taylor.

## Scott arrives

The second son of Eric and Peggy Haarz of N. Harvey Street in Plymouth was born on Feb. 11 at St. Joseph Hospital. Scott Haarz weighed eight pounds, four ounces.

His grandparents are Warren and Vivian Bradburn and Ross and Audrey Haarz, both of Plymouth. Scott's older brother is Teddy, who is three years old.

## Kenneth's here

Weighing in at seven pounds, 11 ounces, Kenneth Parnell Johnson, Jr. was born on Feb. 11. His parents are Parnell and Deborah Johnson of Plymouth.

Grandparents are: Parnell and Lillian Johnson and Diane and Kenneth Rich, all of Plymouth.

## Brittany's born

Brittany Dawn, daughter of Janet and Bruce Beilke, was born on Friday, Jan. 26 at 8:36 a.m. She weighed eight pounds, three ounces at birth. The Beilke family lives in Oak View, Cal. Janet Heindenrich Beilke is a former Plymouth resident.

Brittany's grandparents are: Fred and Wilma Heindenrich of Carpinteria, Cal., formerly of Plymouth; and Ruben and Florence Beilke of Morgan, Minn.

Her great-grandparents are: Mr. and Mrs. Fred Heindenrich of Westland; Mrs. Clifford Smith of Plymouth; and Mrs. Schroeder of New Ulm, Minn.

## Art-lovers spread the word

About 35 volunteers from the Plymouth Community Arts Council attended a lecture on explaining art to kids. The lecture was given by Diane Kirkpatrick, art professor at the University of Michigan, last Wednesday.

The volunteers work in elementary and middle schools in the Plymouth-Canton district as picture and sculpture ladies. There are about 100 volunteers in the program and they visit the schools to help kids develop an interest in art.

Co-chairpersons of the picture lady program are Shirley Peters of Canton and Martha Ahern of Plymouth Township. Carol Carlson of Plymouth is the chairperson of the sculpture program.

If you'd like to volunteer as a picture or sculpture lady, call the PCAC

office at 455-5260 between 9 a.m. and noon.

## It's 'Almost Spring'

The Vocal Music Department of Salem High School will present a choral concert "Almost Spring" on Wednesday, March 14 at 7:30 p.m. at the Salem Auditorium.

Student Mike McGonagle will conduct Psalm 150. McGonagle is an 11th-grade student who also composes music. Sue Hartunian will be the soloist in "One Little Candle." Glenn Carlos is doing the choreography for the show.

The choir is directed by Fred Nelson. The public is invited to the concert. Admission is free.

# what's happening

## FACTS MEETING

FACTS groups from Bird, Isbister, and Smith elementary schools invite all parents to attend a meeting on Tuesday, March 13 at 7:30 p.m. at Smith School. Ray Hoedel, assistant superintendent of business for Plymouth-Canton schools will speak about "Future Projections for Plymouth-Canton schools".

## THREE CITIES ART CLUB

The Three Cities Art Club will meet at 8 p.m. on March 14 in the basement of the Plymouth Community Credit Union at 500 S. Harvey in Plymouth. Eastern Michigan University art instructor Igor Beginin will give a critique of members' work.

## RETAIL MEETING

The Plymouth Community Chamber of Commerce Retail Committee meeting will be held on March 13 at noon in the Miles Standish room of the Mayflower Hotel. Cost for lunch is \$5. Please call the chamber office, 453-1540, to make your reservation.

## CHAMBER BOARD MEETING

The Plymouth Community Chamber of Commerce Board of Directors meeting will be held on Thursday, March 15 at 8 a.m. in the chamber conference room. All chamber members are invited.

## STARKWEATHER SPAGHETTI DINNER

The Parent-Teacher Organization and fifth grades are sponsoring a spaghetti dinner on Saturday, March 10, from 4:30 to 8 p.m. A book fair and open house will also be held. Tickets for dinner are \$2 for adults, and \$1.25 for kids under 12 and senior citizens.

## CENTENNIAL CB CLUB

A business meeting for members of the Centennial CB Club will be held on Saturday, March 10, from 1 to 4 p.m. at the Oddfellows Hall in Plymouth.

## PLYMOUTH COMMUNITY COUNCIL ON AGING

The monthly meeting of the Council on Aging will be on Tuesday, March 13, in the multi-purpose room at the Plymouth Cultural Center at 7:30 p.m. Speaker will be Fred Ferris, director of Detroit-Wayne County area Agency on Aging.

## AMIGO NIGHT

For single parents interested in Plymouth-Canton Parents Without Partners, the PWP is sponsoring an Amigo Night on Tuesday, March 13, at 301 Meadowlake Dr., Canton. For information call 397-0208 or 455-1255.

## L.W.V. ART OPEN HOUSE RESCHEDULED

The art open house originally scheduled for March 18 by the League of Women Voters has been changed to April 8. The open house will be held at the Art Gallery, 459 S. Main St., from 2 to 4 p.m. on April 8.

## APPLE RUN BRANCH MEETING

Members of the Apple Run Branch of the Woman's National Farm and Garden Association will meet on March 13 at 7:30 p.m. at Vi Stevens home, 44755 Dionne. Guests are welcome.

## GUITAR LESSONS

The Canton Township Parks and Recreation Department is sponsoring guitar lessons for third graders through adults. Classes will meet on Fridays from March 23 to June 22. For more information call Barb Abdo at 397-1000, ext. 212.

## TANGER PANCAKE BREAKFAST AND SCIENCE FAIR

Chow down at the Tanger Elementary School Pancake Breakfast on Saturday, March 10 from 9 a.m. to 1 p.m. The school is also sponsoring a science fair display. Kids from four to 12 years old can eat for \$1; adults pay \$1.75; senior citizens can eat for \$1.25; and, family groups of five or more pay \$6.

## PLYMOUTH JAYCEES MEETING

The Plymouth Jaycees will meet on Monday, March 12 at the Oddfellows Hall, 344 Elizabeth St., at 7:30 p.m.

## ISBISTER ART AUCTION

The second annual Isbister art auction will be held on Sunday, March 11 at 1:30 p.m. A light brunch will be served and tickets can be purchased at the door. For more information call Geraldine Barlage at 495-0761.

## PWP ADULT DINNER AND DANCING

Plymouth-Canton Parents Without Partners can dine and dance on Saturday, March 10 at LaFloratina on Newburgh Road in Westland. For reservations call 722-2224 by Friday, March 9.

## DAR SPRING FLING

Sarah Ann Cochran Chapter of the DAR will present fashions by Muirheads of Dearborn at its Spring Fling on March 29 at the Meadowbrook Country Club in Northville. Tickets and information are available from Laura Baumhart (427-6801) or Bebe Lindhout (591-6478).

## LALECHE

"The Advantages of Breastfeeding" will be discussed at the next meeting of the Plymouth LaLeche League on Tuesday, March 13, at the home of Lynne Stollsteimer, 11469 Brownell, Plymouth. Call Dee Stoddard, 459-2796 or Patty Cincotta, 455-3249, for more information.

## OUTSTANDING WOMEN

The Women's Association of the First United Presbyterian Church, at 701 Church Street, will meet on Wednesday, March 14, at 10:30 a.m., to hear Dr. Sam Hudson present "Outstanding Women in the History of Plymouth." Members and guests are asked to bring a dish to pass and their own table service. Babysitting will be provided in the Church's Nursery. No reservations needed.

## APPLE RUN GARDEN CLUB

The Apple Run Branch of Woman's National Farm & Garden Association will meet at 7:15 p.m., March 13 at the home of Vi Stevens, 44755 Dionne, for a poppourri demonstration by Sandi Hicks.

# Club \$ beefs up programs

The Woman's Club of Plymouth recently donated \$575 to various organizations from money raised at club benefits.

Contributions were made to the following groups: the YMCA to help promote its home service program for senior citizens; a local Girl Scout troop to help buy camping equipment; Youth Symphony for scholarship funds; Plymouth-Canton swim teams to help purchase automatic timing devices at the pools; Plymouth Community Arts Council to help support its upcoming show, "Way Off Broadway."

Funds were also contributed to the FISH program, Girls' Town, Plymouth Historical Society, Family Service Organization, and the Plymouth Community Theater Guild.

"It gives us pleasure to be able to make these donations," said Fran Lang, president. The club is willing to accept requests from other organizations, she said. Letters of request may be submitted to Jean Sigmon, Martha Bentley, and Ellen Person, who are members of the Civic Committee. Letters may also be given to Lang.

The next benefit for the Woman's Club of Plymouth will be a luncheon card party at the Plymouth Cultural Center on April 30. The party will begin at noon.

## Funnies go far

Donna Sheridan, daughter of Mr. and Mrs. Donald Sheridan of Canton Township, reached the finals in the Nationwide Invitational Forensics Tournament with her humorous interpretation.

She is a junior at Bishop Borgess High School in Redford Township.

*O. & D.*  
*Bush*  
*Jewelers*  
Designers of  
Fine Jewelry  
Established  
in 1944

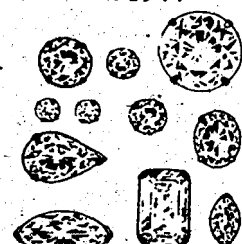

455-3030  
481 Ann Arbor Trail

DIAMONDS

*Geneva's*  
*of Plymouth*  
*Bridal Shoppe*



17 FOREST PLACE  
470 FOREST AVENUE  
PLYMOUTH

Complete Bridal &  
Wedding Party Fashions  
& Accessories

"SPECIAL OCCASION"  
dresses & gowns

phone: 455-4445

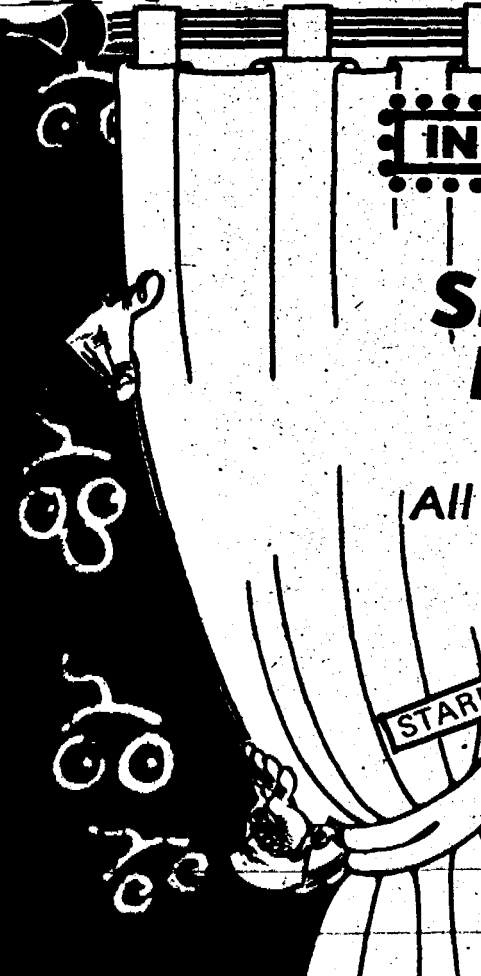

IN THE AIR

SPRING  
FEVER!

All New Gift Ideas!

STARRING THIS WEEK:

Miss Jennifer Pig

and  
the  
sensational...  
"SPROUT MOUTH"

straight from Hollywood!

The house of elegant Gifts ...

CricketBox

at home in Plymouth!

Fairlane Town Center  
593-4420

44461 Ann Arbor Rd.  
Plymouth 455-3332

# 4 stars for cross-country concoctions

MARCH 12 TO MARCH 16  
ALL LUNCHES WITH MILK  
Menus Subject to Change.

**ALLEN**  
MONDAY  
Soup, toasted cheese sandwich, fruit cup.  
TUESDAY  
Sloppy Joes, pickle slices, vegetable, fruit cup.  
WEDNESDAY  
Spaghetti with meat sauce, vegetable, bread & butter, fruit cup.  
THURSDAY  
Hot dog on a bun, relishes, vegetable, fruit cup.  
FRIDAY  
No lunch  
BIRD  
MONDAY  
Ravioli with meat, hot vegetable, brownie, fruit.  
TUESDAY  
Hamburger on a bun, hot vegetable, fruit.  
WEDNESDAY  
Meat gravy over mashed potatoes, hot roll, fruit.  
THURSDAY  
Hot dog on a bun, catsup or mustard, hot vegetable, cake.  
FRIDAY  
No lunch  
ERIKSSON  
MONDAY  
Turkey noodle soup, peanutbutter sandwich, fruit cup, cookie.  
TUESDAY  
Chicken and gravy, mashed potatoes, hot roll, chilled fruit cup.  
WEDNESDAY  
Goulash, hot buttered roll, fruit cup.  
THURSDAY  
Hot dog in bun with relishes, vegetable, fruit cup, cookie.

FRIDAY  
Tacos with trimmings, tossed salad, bread and butter, applecrisp.

FARRAND  
MONDAY  
Submarine sandwich, green beans, applecrisp.  
TUESDAY  
Hamburger on bun, catsup or mustard, tator tots, pickles, fruit, cake.  
WEDNESDAY  
Turkey in gravy over mashed potatoes, peas, jello w/fruit, hot rolls, cake.  
THURSDAY  
Hot dog on bun, catsup or mustard, corn, applesauce, cookie.  
FRIDAY  
No School

FIEGEL  
MONDAY  
Big George's Grilled cheese, baked beans, fruit cup.  
TUESDAY  
Taco's with taco salad, buttered corn, pear halves, Owen's Yummy Cakes.  
WEDNESDAY  
Ryder's roasted weiner w/cheese, buttered peas, carrot/raisin salad, hot rolls.  
THURSDAY  
Pizza burgers, vegetables, fresh fruit cup, Luck O' the Irish Cake.  
FRIDAY  
No lunch, 1/2 day of school

FIELD  
MONDAY  
Hot dog in a bun, vegetable, fruit, pudding.  
TUESDAY  
Sloppy Joe on a bun, vegetable, fruit, cookie.  
WEDNESDAY  
Hamburger gravy, mashed potatoes, fruit, bread.  
THURSDAY  
Irish stew, biscuits, cake.  
FRIDAY  
Overholt's Outstanding Order, Fish sticks, french fries, cinnamon rolls, strawberry banana jello with bananas, peanut and raisin cup.

HULSING  
MONDAY  
Macaroni and cheese or corn dog, buttered bread, green beans, frosted cake, fruit cup.  
TUESDAY  
Chili and crackers, stewed tomatoes, cheese sticks, bread and butter, pudding, diced peaches.



## lunch box

by  
BY W. CHEESEWHIZ LEFTOVERS

This week's menus, as expected, feature several St. Patrick's Day entrees - from lime Jello to special Pat's cake and Irish stew.

But some of the school cooks are ignoring the Irish holiday in favor of other ethnic offerings: from Mexico, the ubiquitous taco; Italy gives the kiddies Spaghetti, macaroni and cheese, pizza and ravioli; and from the good ole U.S.A., the good ole hot dog. Sometimes, however, we see some cross-country culinary concoctions - pizza burgers, for example (a mix of Italy and America).

The cross breeding doesn't stop here, though. At Central on Tuesday, the cooks offer a marriage of the great blue sea and the great yellow arches - baked fish with cheese 'n' special sauce.

At Salem and Canton on Tuesday, the cooks offer the toast of the town: sub meat on a bun. This leaves me a tad confused. Does sub meat mean its below regular meat standards? Or perhaps its leftover from a World War II submarine? Whatever it is, let's just be thankful that these menus aren't illustrated.

WEDNESDAY  
Pizza with meat and cheese, buttered corn, gelatin fruit squares, cookie.  
THURSDAY  
St. Patrick's Day! Hamburger and roll, relishes, tator tots, pickle slices, Shamrock jello, fruit cup.  
FRIDAY  
1/2 day of school, a.m. only  
ISBISTER  
MONDAY  
Sloppy Joe, mixed vegetable, pineapple, butter-scotch bar.  
TUESDAY  
Goulash, buttered french bread, corn, jello with peaches.  
WEDNESDAY  
Hamburger gravy on mashed potatoes, buttered roll, green beans, lemon slush.  
THURSDAY  
Hot dog on a bun, baked beans, fruit cocktail, cake.  
FRIDAY  
Hamburger on a bun, spinach or beets, fruit cup, peanuts.

MILLER  
MONDAY  
Grilled cheese sandwich, vegetable soup, fruit, cookie.  
TUESDAY  
Super Sloppy Joe, french fries, fruit, peanut cup.  
WEDNESDAY  
Pizza  
THURSDAY  
Tacos with meat/cheese and lettuce, bread sticks, buttered corn, apple juice.  
FRIDAY  
Sizzling frank in a bun, baked beans, fruited gelatin, St. Patrick's Day Cake.

SMITH  
MONDAY  
Fish sticks, tartar sauce, buttered bread, peas, pineapple, cookie.  
TUESDAY  
Hamburger on bun, mustard or catsup, green beans, jello with fruit, cookie.  
WEDNESDAY  
Pizza with meat & cheese, corn, applesauce, cookie.  
THURSDAY  
Hot dog on bun, mustard or catsup, french fries, peaches, cake.  
FRIDAY  
No school

STARKWEATHER  
MONDAY  
Macaroni and cheese, buttered peas, peaches, cake.  
TUESDAY  
Taco, green beans, jello, cookie.  
WEDNESDAY  
Hot dog, french fries, sauerkraut, peas, cookie.  
THURSDAY  
Spaghetti with meat sauce, french bread, applesauce, cookie.  
FRIDAY  
In-service, no lunch, school a.m. only

TANGER  
MONDAY  
Grilled cheese sandwich and pickles, tomato soup, apple wedge, bar cookie.  
TUESDAY  
Spaghetti, cinnamon roll, confetti salad, chilled fruit.  
WEDNESDAY  
Salisbury steak, mashed potatoes, orange jello with crushed pineapple, tanger loll bar.  
THURSDAY  
Hot dog in a bun, choice of relishes, french fries, apple juice, chocolate cake.  
FRIDAY  
No lunches, In-Service Day, students dismissed at noon

CENTRAL MIDDLE  
MONDAY  
Coney island hamburger w/onions & cheese, choice of fruit crisp or fruits.  
TUESDAY  
Baked fish w/cheese 'n' special sauce, roll 'n' butter, fry tator, choice of fruit, cookie.  
WEDNESDAY  
Cubed turkey 'n' gravy over egg noodles or mashed potatoes, roll 'n' butter, choice of fruit.  
THURSDAY  
St. Patrick's Day, "Special Luncheon" includes special lime fruit gelatin, special Pat's cake.  
FRIDAY  
Ravioli w/cheese topping, garlic toast, buttered vegetable, choice of fruit or fruity pudding.

EAST MIDDLE  
MONDAY  
Spaghetti and roll, tossed vegetable salad, dressings, applesauce.  
TUESDAY  
Hot ham and cheese sandwich, bean soup, cherry cobbler.  
WEDNESDAY  
Pizza, tossed vegetable salad and dressings, fruit cocktail.  
THURSDAY  
Hamburger or cheeseburger on a bun, pickle chips, tators, chilled peas, chocolate cake.  
FRIDAY  
Grilled cheese with pickle chips, buttered mixed vegetable, canned pineapple, tollhouse bar.

PIONEER-GALLIMORE  
MONDAY  
Hot dog on a bun, or sloppy joe, french fries, fruit, cookie.  
TUESDAY  
Hamburger or cheeseburger, buttered vegetable, applecrisp, cookie.  
WEDNESDAY  
Open faced beef sandwich, mashed potatoes and gravy, buttered vegetable, fruit.  
THURSDAY  
Pizza/meat and cheese, buttered corn, fruit, applesauce cake.  
FRIDAY  
Fish sandwich or peanutbutter and jelly sandwich, chips, buttered vegetable, fruit, cookie.

WEST MIDDLE  
MONDAY  
Sloppy Joe or peanutbutter sandwich, whole kernel corn, fruit, chocolate chip cookie.  
TUESDAY  
Hot turkey sandwich, french fries, fruit, peanutbutter cake.  
WEDNESDAY  
Hamburger gravy, mashed potatoes, carrots, hot rolls, whipped strawberry jello.  
THURSDAY  
Hamburger with trimmings, french fries, fruit or juice, butterscotch squares.  
FRIDAY  
Submarine sandwich or egg salad sandwich, tator tots, fruit, peanutbutter crinkles.

SALEM-CANTON HIGH  
MONDAY  
Hot turkey and gravy, mashed potatoes, buttered sweet potatoes, hot biscuit and honey, jello.  
TUESDAY  
Sub meat on a bun with lettuce, vegetable, soup and crackers, dessert.  
WEDNESDAY  
Sliced ham, scalloped potato, salad with dressing, rolls and butter, applesauce.  
THURSDAY  
Hot dog on a bun, (chili dog or kraut dog) soup and crackers, fruit.  
FRIDAY  
No school  
Ala. Carte Items: Soup, salad, sandwich, hamburger, fries, pizza.

**Laurel**  
FURNITURE  
**BABY CRIBS**  
COME IN & SEE OUR LARGE SELECTION  
584 Ann Arbor Trail Plymouth 453-4700  
Open daily: 9:30-6pm Thurs & Fri. til 9pm

## MARCH SALE 10% off Unfinished Furniture

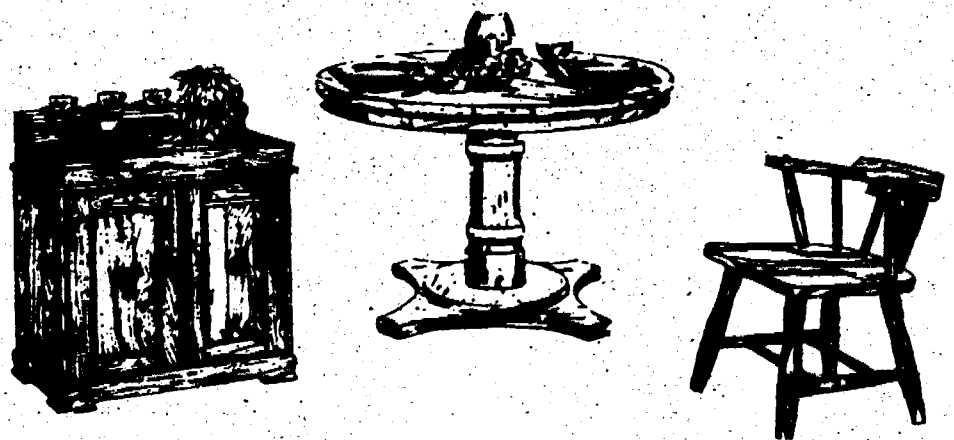

COMPLETE YOUR DECORATING WITH O'BRIEN PAINTS



CUSTOM MIXING AT NO EXTRA CHARGE

## PEASE PAINT & WALLPAPER CO.

453-5100

Mon.-Fri. 9-9  
Sat. 9-6

570 S. Main Street  
Plymouth





## Sheldon gets culvert, pavement

TO PREPARE SHELDON Road, between Ford and Cherry Hill in Canton, for paving, workmen have closed the stretch and are laying a new culvert for Fellows Creek. The road will be closed at least until March 19, although it is open to local traffic. Paving of the stretch is expected to be completed July 15. According to the Wayne County Road Commission, Sheldon will have four paved lanes, 600 feet south of Ford, where it will narrow to two lanes through to Cherry Hill. Sheldon at the intersection of Cherry Hill will not be (Photos by Bill Bresler.)



## Twp. fire dept. rules weighed

BY PHYLLIS REDFERN

Old rules and regulations at the Plymouth Township Fire Department will not be changed until the new fire chief, Larry Groth, has a chance to go through

and study them. Groth went before the township board last Tuesday and asked it to leave intact the set of regulations adopted by the board in May, 1968. Groth said he hoped to have the rules

updated by fall, but admitted it would take time, since his department has many things to catch up on after going without a fire chief for nine months. "Although I don't expect there to be any major changes in the rules and regulations, I look at it as quite a major task," said Groth.

The board did agree that persons working in the department should fill out a form when requesting to trade days off. It stated that the employees could only trade a 24-hour duty day, and recording procedures for trading days would include name of the employee and reason for the request.

and organizations interested in supporting the drive. Organization meetings were held recently in Plymouth Township and Livonia City Hall, with another meeting scheduled to be held in Dearborn.

Joyner's district includes the City of Plymouth and Plymouth and Canton townships.

## County needs exec-- Joyner

In an effort to get an elected county executive in Wayne County, County Commissioner Bill Joyner has initiated a petition drive to place the question on the ballot. The commissioner believes the county needs an administrative leader, someone with authority to manage the day-to-day operation of county offices and departments.

Joyner is looking for individuals

## Legal shield raised

Any member of Plymouth Township Board of Trustees who is sued for actions taken in the line of duty will have his or her attorney fees paid for by the township. Since public officials no longer have immunity from law suits, the board agreed at last Tuesday's meeting that it should have some legal coverage.

It was moved that either the township attorney or an attorney deemed acceptable by board members be authorized to represent board members individually or collectively in law suits pertaining to township business.

## Leather Report

Super soft leather skirts & tops for Spring & Summer.

by Joan Lober  
by Lotus

by Michael  
in forest place



## Twp. budget hearings set

Plymouth Township Board of Trustees set dates for the first three special meetings dealing with the yearly budget.

## ESY kids freed

On March 8, all Pioneer B, C, and D track students will be dismissed at 10:30 a.m. to allow Pioneer teachers to participate in a half-day workshop. Track A will be on vacation at that date.

The first meeting will be held Monday, March 5 at 7:30 p.m. at Township Hall.

At that time the board will meet with Tom Hollis, water and sewer superintendent. On Tuesday, March 6 the board will meet with Fire Chief Larry Groth, and on Thursday, March 8 it will meet with Jim Briggs, chief building inspector.

The budget meetings are open and will be held at 7:30 p.m. at township hall.

## Post Office box robbed by youth

A city U.S. Post Office box was apparently robbed last week.

According to Plymouth Police, a postal employee was leaving the post office at 5 p.m. Thursday when he saw a young boy who "appeared to have the drop door open and his hand inside"

one of the mail boxes on Fralick.

The youth ran to the other side of the mail box and reached into the drop-off snout after the postal employee yelled at him, police report, adding that "he pulled out what appeared to be three or four pieces of mail."

Police said the youth then ran to a black and red station wagon which was waiting with a driver and then sped off east on Fralick.

The youth was wearing a dark jacket and appeared to be 10 to 12 years old, police report.

## Petitions filed for Heights

Cont from pg. 1

ship Clerk Esther Hulsing.)

Plymouth Township officials believe that keeping the Plymouth Heights incorporation alive will block annexation of the township by the City of Plymouth.

Incorporation of the city of Plymouth Heights was approved on Feb. 16, 1959 by a vote of 575 to 510. But a city is not technically formed until a charter is adopted and the recent defeat was the seventh time voters had rejected a charter.

If the petitions filed Monday are found to be legally sufficient, an election will be called to choose a new charter commission.

That commission will then draft a new charter which must be put before the voters.

## Twp. to sell air coolers

If you're anticipating the hot months ahead, and looking for a good buy on a used air conditioner, check with officials at Plymouth Township.

The township is selling seven air conditioners with 1,000 BTU units and two with 10,000 BTU units, from the Teledyne Building, which will have central air conditioning installed during the current remodeling project.

**McAllister's**

Your Complete Beverage Store.  
On Northville Rd. opposite the Plymouth Hilton  
7 a.m. til 11 p.m.  
455-9363

Beer \*Package Liquor (incl. 1/2 gals. & gals.) \*Over 200 types of Domestic & Imported Wines.  
\*Champagnes \*Meats \*Keg Beer  
\*Groceries

# Sports

## Salem cagers mop up Wayne Memorial, 79-52

BY E. DALE LEE

Buoyed by a fine inside game and a stingy defense, Salem High thrashed Wayne Memorial in the opening round of district basketball play at home last night, 79-52.

Wayne Memorial surprised almost everyone by not going into a four-corner stall offense immediately.

Even more surprising was the fact that the Zebras avoided a slow-down game entirely—but Rock Coach Fred Thomann wasn't fooled.

"We didn't prepare exclusively for a slow-down type of game," he said. "Whatever they went with we changed spontaneously."

"Our defense is what we've lived on all year long," Thomann continued. "We like to get after people. We do that the best."

Zebra Coach Steve Schwartz was quick to explain why his club went to the running game.

"We couldn't match Salem's quickness in the man-to-man situation," he said. "They really put good pressure on us."

"The reason we lost is because Salem outworked us on the boards—and because we couldn't handle the ball well," Schwartz explained. "And we're not a good shooting team, either. We're averaging only about 33 percent of

our floor shots this year."

Zebra center Darryl Jordan fouled out of the contest with 7:46 left in the fourth quarter—with no points. He had been Wayne's only offensive threat going into the contest. Schwartz said Jordan has been hot and cold of late. "He wasn't a factor tonight," he said in an obvious understatement.

Wayne Memorial actually led once, 2-1, before the Rocks took advantage of a comedy of Zebra turnovers—mostly on inbounds passes—for a 25-8 Salem bulge after the first period.

The 12 first quarter turnovers weren't the end for Wayne Memorial. The second period gave Salem a 39-20 half-time margin on the strength of more turnovers—most of these from overthrown long passes.

The Rock Express hit high gear in the third quarter—20-10—building up an insurmountable 59-30 difference. In the fourth session Thomann substituted, but the Zebras only outscored his club by two points for the 27-point triumph. The lead stretched to 36 points late in the contest.

Rich Hewlett led the scoring parade for Salem with 17 points, followed by Bill Thimm (13), Howard Monk (11), Rob Neu (10), Matt Etienne (10), and Jim Anderson (8). Jordan failed to tally for Wayne Memorial and Kelvin Lee

Continued on page 18



SALEM HIGH guard Matt Etienne lays in two of his 10 points last night against Wayne Memorial High. (Crier photo by Bill Bresler).

## Junior baseball sign-ups scheduled for Saturday

The Plymouth-Canton Junior Baseball league will hold its registration for the 1979 summer baseball season on the next two Saturdays—March 10 and 17 at the Plymouth Canton High School cafeteria from 9 a.m. to 3 p.m.

All boys and girls in the Plymouth-Canton community who will be seven years old on or before July 31, 1979 and no older than 16 on or before this same date may register on one of these Saturdays. Proof of age is required.

All participating players may register in the following leagues: "C" League (boys and girls seven and eight years old) fee \$11; "B" League (boys 9-10 years old) fee \$13; "G" Jr. League (girls 9-12 years old) fee \$11; "A" League (boys 11-12 years old) fee \$13; "F" League (boys 13-14 years old) fee \$15; "E" League (boys 15-16 years old) fee \$15.

Umpires and managers are also needed for this season, along with an umpire-and-chief and an "A" League director. The umpire positions are pay positions while managing is volunteer. Any adults interested in one of these positions should call Jim Schols at 397-3940 or Jeanne Goodrich at 459-3640 for more details.

Anyone interested in volunteering to help with registration may call Ivan Haynes (459-4133) for more details.

## Jr. basketball winners

Weeks of sweat and hard work have finally paid off in the way of a championship for six teams in the Plymouth Junior Basketball League.

Saturday afternoon the Bucks captured the Boy's AAA League trophy by edging the Jazz, 80-76. The players in this league come from 11th and 12th grades at Canton and Salem High Schools.

The Dolphins copped the Girl's AA League title by dumping the Jays, 32-24. Performers here come from the 8th, 9th, and 10th grades.

The Wolverines got by the Badgers, 52-43, in the Boy's AA League (8th,

9th, 10th grades) journey for a first-place in that competition.

The Cougars laced the Celtics by a 37-32 count in the Boy's A League championship. The players are in the 6th and 7th grades.

The Dolphins walloped the T-Birds in the 5th, 6th, and 7th grade Girl's B League title game for the championship.

The Boy's B League titlist is the Hawks, who whipped the Darts in the championship game at Pioneer Middle School, 49-29.

Thank goodness for the goodness of... *Famous Recipe*  
FRIED CHICKEN  
Grandma's Take Home

**HEY!!!**  
want to buy a **BIG DINNER**

at a small price?

*Famous Recipe*

**MONDAY — and — THURSDAY** **\$1.59** Reg. \$2.10

*Famous Recipe* FRIED CHICKEN  
Grandma's Take Home  
Prepared for You

1122 W. Ann Arbor Rd. 452-5767

3 pieces chicken  
coleslaw - hot biscuits  
mashed potatoes  
gravy

# Salem wrestlers beaten at Kalamazoo

BY E. DALE LEE

"I'd like to have done better," was about all Salem High varsity wrestling Coach Ron Krueger could say after his three qualifiers in Saturday's State championships at Western Michigan University in Kalamazoo were eliminated from the field.

"We broke all but two varsity wrestling records this season with a bunch

of juniors," he said. "So I'd have to say our season was a success. Next week we start lifting weights for next season."

Scoring five team points in the play-offs, Krueger says his team has the experience now and has learned what they have to do to win next time.

98-pound Rock Jim Schultz had the best day among the local qualifiers,

winning his first match against Grandville's Mark Nessner by a 15-2 count. Schultz then dropped decisions to Lansing Eastern's John Swix (11-2) and Temperance Bedford's Jack Roth (10-5) for elimination.

Rock 112-pounder Jeff Brown shut-out Holland West Ottawa's Lance Lamar (4-0) before dropping 12-9 to Flint Northwestern's C.J. Herron and 8-3 to Washington Eisenhower's Pete Pehur.

126-pound Salem representative Mark Ross dropped a 5-3 final to Port Huron Northern's Greg Jones before suffering a heartbreaking 1-0 setback to Grandville's Keith Russell in the double-elimination field.

"He lost a couple of real tight matches," Krueger said.

## 10-0 league mark Chief cagers rout Mustangs

BY E. DALE LEE

Despite an off-night from star forward Butch "Sky" King at the Canton High gym Friday night, Chief Coach Craig Bell was all smiles following his club's 77-69 lashing of Northville, which gave him a 10-0 Western Six League final record, 16-4 overall.

"Northville came here hoping to upset us, and we met their challenge," said Bell, who copped the crown in this, his first year at the Chief helm. "We controlled them in the second half."

Canton held a 37-32 lead going into the third quarter after a 22-19 first quarter margin.

The Chiefs held Northville scoreless for the first three minutes and 10 seconds of the third quarter. But Canton's offense wasn't stymied, tapping in nine points during that time on a pair of layups, a jumper, and three free throws, leading by 14, 46-32, at that point.

The game continued to spurt along as the Mustangs tallied the next six. Canton pushed in the next five... leading by a 57-48 count after three quarters before building the game's biggest bulge - 18 points (68-50) - with 5:37 left in the contest.

King played sparingly in the match-up, scoring 18 points to lead Canton. Still, the senior missed 10 field shots - six in the first quarter.

"Butch King can't play a spectacular game every time out," offered Bell. "Luckily the other kids picked up the tempo. He still scored 18 points so the points were there."

Northville never really had Canton on the run, yet Bell says the Mustangs were a team to be reckoned with Friday.

"We knew they were coming to our gym jacked up," he explained. "We weren't mentally ready to play, but they never had us scared."

Bell believes his second-half control of the tempo produced the win. But he also pointed out some flaws in his club... specifically, reaching in.

"Sometimes we had mental lapses," Bell said. "Other times we had turnovers because of on-court physical problems. But we played a zone and there were less fouls than a man-to-man defense so I'm satisfied."

In addition to King's 18 points, Mike Leary threw in 15 and added nine rebounds. Center Mike Gollnick also grabbed nine rebounds for the Chiefs.

Continued on page 19



### Stroke, stroke, stroke ...

SALEM HIGH'S BOB SIMRAK RACES to a winning 5:31.6 time in the 500-yard freestyle event against Dearborn at home last Thursday. Unfortunately for the Rock tankers, the Pioneers came out on top, 97-75, in the last match-up of the campaign. (Crier photo by Bill Bresler).

## Salem loses too Canton volleyballers bopped by Westland

BY PATTY RADZIK

The Canton High volleyball team dropped its chance of advancing in district play Saturday, falling in the second round to host school Westland John Glenn, 15-8, 15-9.

"It was silly," Chief Coach Cindi Burnstein commented. "We made a lot of mistakes, which doesn't usually happen to us during a game." A strong serving team, Canton missed five service hits in the first game and seven in the second.

Also upsetting Canton's performance was the absence of star player Kelly Heaton. Heaton slipped on the ice last week and needed an operation on her ankle to place a screw in the bone and to repair torn ligaments.

"Overall, we didn't play badly," Burnstein said. "But if Kelly were there, we would have put it away."

Burnstein complimented Claudia Williams and Cindy Sovine for their spiking and also said Mary Reirson had a good game.

The Chiefs, 9-2 in the league, plays a make-up game at Walled Lake Western tomorrow.

Salem High also would have played in Saturday's districts had it not been for a loss to Farmington in Pre-district competition Wednesday.

After closing out their season with a defeat to Dearborn, the Rocks lost to Farmington 15-11, 13-15, 10-15, in a very controversial match.

Coach Cathy Himes was upset with the officiating, and also filed a complaint before the game started, saying that the playing court was illegal. The boundary lines were one inch wide, opposed to the legal size of two inches.

Himes appealed her case to the State board, but they turned down her request to have the contest replayed.

Salem finished the season with a 7-10 record, and most likely will wind up in fourth place in the Suburban Eight League.

**SLASHED!**

**SAVE NOW  
AS NEVER  
BEFORE**

**Armstrong  
Designer Solarian**

Installed with a 1/4 inch plywood subfloor. (steps extra)

9 x 12 (12 sq. yds.)	COMPLETE .....	<b>\$230<sup>00</sup></b>
10 x 12 (13 1/2 sq. yds.)	COMPLETE .....	<b>\$255<sup>00</sup></b>
11 x 12 (14 2/3 sq. yds.)	COMPLETE .....	<b>\$275<sup>00</sup></b>
12 x 12 (16 sq. yds.)	COMPLETE .....	<b>\$295<sup>00</sup></b>
13 x 12 (17 1/4 sq. yds.)	COMPLETE .....	<b>\$320<sup>00</sup></b>
14 x 12 (18 2/3 sq. yds.)	COMPLETE .....	<b>\$350<sup>00</sup></b>
15 x 12 (20 sq. yds.)	COMPLETE .....	<b>\$380<sup>00</sup></b>

Giant Savings on Royal Solarian, Sundial and Imperial Solarian

Buy your Solarian from an Armstrong Floor Fashion Center.

\*We are trained by Armstrong

\*Installation Guaranteed by Armstrong

**FLOOR  
FASHIONS  
of Canton**

**YOUR COMPLETE**

**HOME DECORATING  
CENTER  
HARVARD SQUARE PLAZA  
5854 SHELDON ROAD  
AT FORD ROAD  
459-6180**





# Chief basketball crowds have a lot to learn

While not peculiar to the Plymouth-Canton area alone, the supporting crowds at Salem and Canton High Schools have a lot to learn about class.

I can't believe that a crowd would walk out of a basketball arena during the last two minutes of a game involving their favorite team. I'm not talking about one, two, or ten people. I'm talking about an en masse evacuation like Friday's at the Canton-Northville game.

Walking out on a team that clinches championships is unbelievable, unless you agree that the Western Six title is meaningless. Chief Coach Craig Bell says it doesn't bother him when the fans leave as quickly as they did Friday.

"They can leave if they want to as long as they support us," he said. "But I would be upset if we were behind and they did the same thing."

"I'll be interested in seeing how you fans stick to your seats in tomorrow night's Canton game at Salem."

\*\*\*\*\*

The Junior Baseball League registration Saturday proved to be the most successful opening week in the circuit's history, according to Jim Schols, who's coordinating the programs.

"Last year we were worried that we wouldn't be able to fill all our leagues," he

## Pee Wees in playoffs tomorrow

It's state playoff time for 11 and 12 year old hockey players on the Osburn Trucking team in Plymouth's "AA" Pee Wee League. Plymouth has won four games and tied one in post-season action to earn a berth in the finals in Fraser on March 8, 9, 10, and 11. They will compete for the District Five championship.

Plymouth dumped Westland (7-1 on Feb. 19), Livonia (8-2 on Feb. 20), Garden City (4-1 on Feb. 25), tied Farmington (5-5 on Feb. 26) and whitewashed Garden City again (4-0 on Feb. 27).

If Plymouth pulls out the first-place trophy in Fraser, it will advance to national competition at an unnamed site.

The 15 member squad includes: Coach Sy Smith, Assistant Coach Jeff

## Jr. tankers fall twice

The Plymouth-Canton Junior Swim Club dropped meets recently to Willow Run and Belleville. They lost to Belleville, 359-345 and to Willow Run, 381-310. These defeats closed the regular season for the junior tankers, but they compete in the league meet Saturday.



E. Dale Lee

sports editor

explained. "There's nothing close to an opening week registration that we've had this year."

Schols says that over 900 kids signed up by 2:10 p.m. Saturday - more than half the amount needed - and recommends an early start for interested players this Saturday at Canton High's cafeteria.

Although it's going along as smooth as silk now, Schols' league needs umpires, managers, and ballfields.

"Managers have been volunteering all afternoon, so we should be able to fill the teams rather quickly," Schols added. "But we need umpires. That field is going badly."

The diamond problem may be rectified soon. Township Park on Ann Arbor Trail is already set for league usage, but Schols and the league are waiting to hear from the Plymouth-Canton Board of Education to use the fields at East, West, Haggerty, Canton, Pioneer, and Central Middle Schools. He is also trying to get two fields at the Canton Center-Cherry Hill intersection.

Like most leagues, this one needs money. There's a candy bar sales drive going on now but interested people can buy a bar at the K-Marts at Ford and Sheldon Roads on March 11 from 1 until 3 p.m.



THE 1978-79 OSBURN TRUCKING PEE WEE PLAYOFF HOCKEY TEAM

Mooney, Assistant Coach Ron Simsick, Manager Charlie Norton, and players Don McMahon, John Longridge, Steve Erps, Danny St. Germain, Doug Campbell, Joe Carlson, John Figuecki, Chuck Norton, Tim Osburn, Chuck Papenfus, Don Perrin, Rob Simsick, John Smith (captain), Rob Wells, and Rodney Williams.

A spokeswoman for the team says this is the farthest a Plymouth Pee Wee hockey team has advanced in this type of competition.

## Eric Cole to fight

The Golden Gloves Quarter Finals at Huron High in Ann Arbor (2727 Fuller St.) Saturday night will be of major concern for one local pugilist - Plymouth's own Michigan Junior Olympic Champion, 13-year-old Eric Cole.

The action is set to begin at 8 p.m. and is sponsored by the Ann Arbor Boxing Club. Advance tickets can be obtained by calling 662-6265, 971-2016, or 434-4540.

## Salem knocks up Wayne Memorial

Continued from page 16  
only scored one point, but Kyle Poteau pushed in 17 to pace the losers.

Salem, now 19-2 on the campaign, faces lowly Garden City East tomorrow night at home in the second-round at 8:30 p.m. Canton High will battle Westland John Glenn at 7 p.m. in the first game at Salem following the Rockets' 72-60 win over Garden City West Monday night.

## Canton High gymnasts top Truman

BY PATRICIA BARTOLD

After finishing a successful 9-3 regular season, the Canton High girl gymnasts are practicing for regional competition on Saturday. The competition begins at noon at Troy Athens High.

Monday night, the Chiefs trounced Taylor Truman High by more than 10 points, 90.90 to 80.85.

Canton relied heavily on Katy Heaton, Leslie Bublin and Wendy Gray as they captured first places in three of the four events.

Heaton took a first in vaulting. Gray snatched second place honors.

On the uneven parallel bars, Gray captured first place with Bublin coming in third. Cougar Terri Lee Smith took second place on the bars.

Bublin then took first place on the balance beam supported by Gray, who copped second place.

The only event the Chiefs didn't win was the floor exercises as Smith dominated. Gray scored a second place while Bublin and Heaton tied for third place.

## Monk scores 25

# Salem trounces Belleville

BY E. DALE LEE

Center Howard Monk parlayed 11 rebounds into a team-high 25 points Friday night to lead Salem High to a 76-57 basketball victory at Belleville.

"I'm glad that we beat Belleville twice this year," Salem Coach Fred Thomann explained. "Now we'll go on to next year."

Next year for Belleville, maybe, but this season isn't over. The win upped the Rocks' Suburban Eight League record to 11-1 and their overall mark to 18-2, good enough for the Plymouth school's sixth-straight conference crown.

Thomann is quite happy about his fine season.

"You'd like to think you can win all 20 of your games," he said. "But your goals have to change as the season goes on and ours did."

Salem opened with an 18-15 edge in the first quarter before taking a 37-32 halftime margin.

The Rocks then bucketed 18 third-quarter points to lead, 55-47. Thomann's troops then went on a final period rampage, 21-10, to ice the verdict.

"We spurted in each quarter," Thomann explained. "But they came back and closed the gaps. In the fourth quarter we warmed it up."

Besides Monk's fine performance, Kevin Kelliher pushed in 12 points, Rich Hewlett 11 (with 10 rebounds and seven assists), and Bill Thimm 10. Rob Neu and Matt Etienne dished off five assists each. Herbert Burris tallied 28 points to pace the losers.



100% 447 Forest Ave.  
NATURALLY  
FLAVORED ICE CREAM  
453-4933

Our Ice Cream is made  
right here in Plymouth.  
It is the best you can buy

OPEN 365 DAYS A YEAR

(not fountain items) Drive-up Window Service

ANNUAL WINTER  
ICE CREAM SALE  
(All Flavors on Sale)

1/2 Gal.

\$1.59 Reg. \$1.79 &  
\$1.89  
\$1.69 Reg. \$1.99 &  
\$2.09

Plymouth - 447 Forest Ave.  
Garden City - 28650 Ford Rd.  
Livonia - 34211 Plymouth Rd.  
Northville - 134 N. Center St.  
and All Cloverdale Retail Outlets

# 113-59 annihilation Canton swimmers gyrate to 12-0 by thrashing Northville

BY PATRICIA BARTOLD

The Canton High tankers zipped by Northville on Thursday night, 113-59, the last home meet of the year. This victory gave the Chiefs a flawless 12-0 season record and made them top contenders for the Western Six League championship next week.

"On paper there should have been only a five or 10 point difference, but we clinched first places right at the start of the meet and didn't let up," said Coach Bill Faunce, adding that the Chiefs' only loss came in the 100-yard backstroke.

Against Northville, five Chief seniors, Bob Cline, Mike Gaab, Pat Gilligan, John Hawkins, and Dave Tanner swam for the last time at home.

Canton opened the meet by taking

a first place in the 200-yard medley relay. Cline, Paul Petersen, Ron Hurley, and Gaab swam the event in 1:45.9.

The team of Jeff Seippel, Hawkins, Vince Tobin and Gilligan dropped three seconds off their time to clinch a third-place in 1:53.3.

In the second event the Chiefs scored a grand slam by taking first, second, and third places. Bob Simrak took first in 1:56.5; Troy Haarala captured second in 2:02.1 and Keith Greenleaf snatched third in 2:02.6. "This event set the tempo for the rest of the meet," said Faunce.

Cline raced in to a first in the 200-yard individual medley in 2:10.8.

In the 50-yard freestyle, Petersen and Tanner swam in for a baby slam. Petersen's time of 23.2 was one-tenth of a second off his best time of 23.1.

He placed first with Tanner coming in inches behind at 23.3. Their points raised the Chiefs' score to 43 points while the Mustangs had 19.

Diver Steve Gray turned around to beat Paul Cooper at home after Cooper had defeated him previously at Northville. Gray's score was 206.2, his highest score of the season.

In the 100-yard butterfly, Hurley set a new freshman record by stopping the clock at 58.6. He took a first place.

Tanner captured a first place in the 100-yard freestyle in 51.1. In the following event, Chiefs Simrak and Haarala cinched a baby slam. Simrak's time was 5:31.6, and Haarala stopped the clock at 5:35.7.

Petersen turned a former defeat into a victory as he captured a first-place in the 100-breaststroke by beating Mustang Tim Cahill. Petersen's time of 1:01.2 set a new varsity and pool record. Cahill's time was 1:03.1.

The team of Hurley, Simrak, Gaab, and Tanner closed the meet by taking a first place in the 400-yard freestyle in 3:33 flat.

Faunce was also pleased because many of his swimmers improved their times. "We're favored for the league championship, but it will be a challenge. Northville has been league champion for the past four years and the Mustangs will be harder to beat than during a dual meet.

"To capture the championship, we'll need the strength to take first places as well as the depth to cinch some fourth, fifth, and eighth places," said Faunce. "We can't change the events our swimmers will compete in after Monday and other coaches will guess about 80 per cent of the events we'll place our swimmers in."

The preliminaries will be at 4 p.m. on March 8 at Farmington Harrison with the finals at Harrison on March 9 at 7 p.m.



CANTON HIGH SWIMMER RON HURLEY displays his winning form in the 100-yard butterfly event Thursday night. (Crier photo by Bill Bresler).

Serving  
**PLYMOUTH-CANTON**  
COMPLETE OFFSET  
PRINTING SERVICE  
featuring 3M 412 CAMERA  
Call  
453-6770  
**Pilgrim Printer**  
632 S. Main Plymouth

## Salem swimmers dunked

BY PATTY RADZIK

The Salem High boy's swim team failed in its bid to win the final contest of the season, bowing to Dearborn Thursday, 97-75.

Bruce Harwood, Bob Simone, Kirk Albert and Dave Hopper gave Salem an early lead by capturing the medley relay race in a time of 1:46.1.

Russ Schaffer finished third in the 200 yard freestyle event with a 1:58.5 timing and later placed second in the 500 yard version with a time of 5:17.5.

Albert came in second with a 2:13.8 timing in the 200 individual medley, followed by a victory in the butterfly race in a time of :54.7. Barry Lee placed fourth in the fly, after finishing second in the 50 freestyle with a :23.6 time.

Joe Rudlick captured fourth place in diving competition with a total of 163.1 points. Jim Melnick came in fifth.

In the 100-yard freestyle, Scott Pladgens swam to a second place finish while Harwood placed the same in the

100-yard backstroke.

Simone placed second in the 100-yard breaststroke with a 1:05.0 timing while teammate Jeff Stella came in third with a time of 1:05.7.

The final event of the night found the Rocks in second place, as Pladgens, Jeff and Mike Stella and Schaffer stroked to a 3:40.0 timing in the 400-yard freestyle relay.

"Dearborn was better than us in the freestyle races," Salem Coach Chuck Olson said. "What really hurt us was their 1-2-3 finish in the diving.

"It was as close to Dearborn as we've ever been," Olson continued. Salem has never beaten the Pioneers.

According to Olson, all of his swimmers are ready for the Suburban Eight League meet, to be held tomorrow and Friday at Schoolcraft College. "We've got Bentley, Dearborn, Belleville and Trenton in front of us and Allen Park and Edsel Ford behind us," Olson stated. "We're in pretty good shape. I think we can do it."

## Chief cagers close out

Continued from page 17

and pushed in 12 points. Rusty Mandle dished off 10 assists and Dave Visser chipped in with 10 points.

Northville dropped to 10-10 (overall) and 5-5 (Western Six League) on the year. Bob Crisan paced the losers with 22 points and Joe Schimf scored 19.

Thursday Canton is set to play in the second round of the Salem district after drawing a first-round bye. Bell is optimistic that his team will do well.

"We want to keep on winning," he said. "We're not going to be satisfied with one district win. But it won't be a halocaust if we lose the district, either. I'm very proud and satisfied of my team."

## WSDP radio to air district basketball games

District basketball play is underway at Salem High this week for the Rocks and Canton High. For fans who can't cram into one of the 2,300 spaces for the games, WSDP radio (88.1 FM) will broadcast contests involving the two local clubs.

Sports Director Jon Hewlett, Chris Koepke, George Hamblin, and Ross Reinhart will handle play-by-play and color chores for the games. In case of

a Salem-Canton match-up, Hewlett and Koepke will combine.

IN OLD VILLAGE ITS  
**Bill's Market**  
584 Starkweather,  
PLYMOUTH 453-5040  
**BEER & WINE TO TAKE OUT**  
**GROCERIES • PARTY SNACKS • MEATS**  
**SANDWICHES • DELICATESSEN**

COUPON GOOD THRU APRIL 29, 1979

**SAVE**

up to

**50¢**

**DAWN DONUTS**

**A.M. SPECIAL**

- 2 Donuts or Rolls
- Cup of World Famous Coffee
- Juice

ONLY **75¢**



Dawn Donuts of Plymouth

# Let kids pursue answers, educator says

Let kids take responsibility for pursuing the answers to questions they are curious about, said Vincent Rogers to a group of about 250 parents and teachers on Monday night.

Rogers, accompanied by his partner Joseph Renzulli, spoke to parents about talented and gifted kids and techniques for teaching them at the Salem High School Auditorium. Rogers and Renzulli are considered to be early forerunners who helped develop TAG programs throughout the country. They visited the Plymouth-Canton school district from

Connecticut.

Renzulli said a combination of above-average ability, commitment to pursuing answers, and creativity helps to identify TAG students. "There is too much emphasis placed on tests," he said. He suggested a student's interests and learning styles also be considered in teaching TAG students.

The enrichment triad was also discussed by Renzulli. This model was developed for teaching TAG students and covers three levels of learning exercises.

The first level asks teachers to expose kids to a broad range of experience in the regular classroom. "Certain enriching experiences should be provided to all kids," said Renzulli.

The second level, called group training activities by Renzulli, is a training process or "how-to" process. Critical thinking, analysis, and self-awareness are examples of processes that affect different areas of learning and the student constantly, said Renzulli.

The third area stresses investigation

of real problems. He suggested students tackle problems they are naturally curious about. "Don't forget to let the student report on his project to an appropriate audience," he said, which could include township boards investigative teams, and other official groups.

"Creativity comes in many different forms," said Rogers. Ironically enough, Renzulli commented that TAG programs today would probably exclude a great number of creativity thinkers from the pages of history.

## Can Canton corral fast food palaces?

*(Editor's note: The Canton Planning Department is holding a series of classes on growth and planning in the township. Any citizen who wishes to learn how development is managed is welcome to attend. To introduce the basic subjects of the course, The Crier presents the third of a series of articles written by Canton planners.)*

Growth in Canton Township is a large and complex issue that touches on several issues, such as agricultural preservation, fast food restaurants, traffic and roads, industrial development, the tax base and zoning; literally everything from A to Z.

Looking at one of these issues the proliferation of fast food restaurants, in terms of its effect on growth in the township is a good way to understand the complexities of the problem. Many residents see these establishments as a symbol of undesirable urban growth. Others in the township enjoy the convenience and the wide choice of restaurants that are available.

Arguments against fast food restaurants list the increase in traffic, litter, the lack of aesthetic qualities, and the concentration of restaurants along Ford Road as problems. But, if there is a clear public demand evidenced by large numbers of pizza, tacos, fish, chicken and burgers being sold, should the township try to limit the number of

these establishments?

Commercial property owners have the same property rights as any one. Can the Township limit their rights by not allowing more fast food restaurants? How far can the township go in controlling the use of private property?

The state grants the township the power to regulate land and its use for the protection of the health, safety and welfare of the community. This power is expressed in the zoning ordinance. But power is meaningless or harmful without direction and purpose, which is supplied by clear goals for the future.

The kind of community that Canton will be to live, work, or shop in over the next five, 10 or 20 years is shaped by decisions made today. Much of the resistance to growth and fast food restaurants in particular is based on goals that demand that Canton remain well balanced, attractive and interesting.

These are not questions that are simply resolved and there are many sides and many related issues. Goals for Canton's future will achieve clarity only with continued interest and expression of citizens opinions.

If you have an opinion about Canton's future on any of the issues raised please express it. If you want to talk over your views, the seminars are continuing at Township Hall on Monday, March 12 at 7 p.m. Call the Planning Department at 397-1000 for information.

## Patricia wins scholarship

Patricia Ann Shefferly of Canton Township has been named winner of the Plymouth Elks' Most Valuable Student scholarship contest.

Patricia will receive an award of \$200.00 from the Elks, but more importantly her name has been submitted for state and national Elks scholarships competition which could mean an award of from \$700 to \$12,000.

Patricia was selected from among seven local senior girls on the basis of academic achievement, leadership, and need. An identical scholarship is annually awarded to the most qualified senior boy, but this year no boy applied.

Patricia is the daughter of Robert

## McMurray tapped

Frank McMurray was elected president of the Canton Chamber of Commerce at a special Board of Directors meeting on Feb. 21. He succeeds Mary Perna.

Other officers chosen were: John Schwartz, first vice president; Bill Tesen, second vice president; Jim Fulkerson, secretary; and Richard Potter, treasurer.

Also, the following persons were elected to the board: Perna, Eldon Johnson, Al Daly, Bill Brown and Dr. Richard Kirchgatter.

and Lorraine Shefferly of 44782 Hanford, Canton. She attends Salem High School and plans to attend the University of Michigan's School of Nursing in the fall.

## 'Go Ask Alice' called educational

BY PATRICIA BARTOLD

After a review by a school-appointed committee, the book "Go Ask Alice" will remain on the library shelves of local middle and high schools.

This recommendation was made after Dorothy Davison of Plymouth Township objected to the book's language and called its contents "smutty." Her charge prompted school officials to review the book. The book is about a 15-year-old girl who runs away from home and eventually dies of a drug overdose.

According to the committee report, "The language in the book is reflective of the tragic story and aids in the author's intent."

"This committee in no way condones the use of foul language, yet, placed in proper context, it can be an effective tool, as in this book, demonstrating the gradual deterioration of a teenaged girl under the devastating effect of drugs."

## community deaths

### Krampitz

Edna L. Krampitz, of Plymouth Township, died on March 3.

She is survived by her daughters, Marilyn Revell and Emily Ruehr; brother, Harvey Browe; and grandchildren, Sharon and David Revell.

For information about funeral arrangements, call the Harry J. Will Funeral Home, 37000 Six Mile Road, 591-3700.

### Meader

Gertrude Meader, 85, of Farmington Hills, died on Feb. 26 there. Funeral services were held on March 2 at Schrader Funeral Home with The Rev. Theodore D. Taylor, II officiating. Burial was at Riverside Cemetery.

She is survived by her brother, William Bakewell of Grayling.

Mrs. Meader was a former area resident and homemaker.

### Gibson

Elizabeth (Louise Froehlich) Gibson, 63, formerly of Plymouth, died Feb. 19 at Good Samaritan Hospital in Phoenix, Ariz. She graduated from Radcliffe College, Cambridge, Mass., in 1937 and moved to Michigan, residing in Plymouth nearly 20 years.

She taught elementary grade school in Plymouth for several years and retired to Wickenburg, Arizona, four years ago.

Surviving are her husband, Walter; son, Jim of Port Washington, N.Y.; daughters, Nancy Smith of Plymouth, Bonnie of New York City; Kate of Ann Arbor; sister, Gretchen Sharp of Ridgefield, Conn.; and, five granddaughters.

### Counts

Eugene Edison Counts, 57, of Canton, died on March 4 at St. Mary Hospital in Livonia. Funeral services were held on Tuesday, March 6, at Schrader Funeral Home with The Rev. Willard Martin officiating. Burial was at White Chapel Cemetery.

He is survived by his wife, Helena; sons, Mitchell of Plymouth, Kyle of Santa Monica, Calif., Terry of Canton, Rick of Canton; daughters, Diane of Plymouth and Joanne of Berkeley, Calif.; sisters, Opal of Clintwood, Va., Selma of Troy, Mildred of Michigan; and, two grandchildren.

Mr. Counts was an insurance salesman for the American Automobile Association in Livonia. He came to the community in 1968 from Detroit.

Memorial contributions can be made to the American Cancer Society.

### Jacobsen

Lawrence Michael Jacobsen, 46, of Detroit, died on March 1 there. Funeral services were held on March 5 at Our Lady of Good Counsel Church with The Rev. Fr. Edward J. Baldwin officiating. Burial was at Holy Sepulchre Cemetery. Arrangements were made by Schrader Funeral Home.

He is survived by his parents, Mr. and Mrs. Victor Jacobsen of Greenville; brother, Victor J. Jacobsen, Jr. of Farmington; sisters, Mary Jo Markey of Duluth, Minn. and Thora Chevillot of Canton.

Mr. Jacobsen was a certified public accountant and a member of the C.P.A. Association and the University of Detroit Alumni.

be available if students have any questions.

Asked her reaction to the committee's review, Davison said, "If that's the way the committee voted, that's the way our country works."

"I just thank God I've taught my kids enough morals so that they'll choose not to read this book. I feel sorry for the kids whose parents don't provide guidance for their kids," she said.

## Salem speakers cop 4th

Salem High finished fourth in a field of 24 teams at Saturday's Plymouth Invitational Forensics Meet.

Albion took first, followed by Wayne Memorial and North Farmington.

First place winners for Salem were Sue Sharp in impromptu speech, and Cheryl Nowak in informative speech.

Finishing second were Jay Finch in informative speech, and Gina Massaro

for serious interpretation.

The Rocks also had two finalists: Mary Bologna, humorous reading; and Mark Sampson, oratory.

Semifinalist for Salem were Jill Harper and Cathy Handyside, storytelling; and Mike Hammonds and Colleen Geary, radio and broadcasting.

Canton also had a semifinalist, Robin Holley, in serious interpretation.



\$2.50 for the first  
10 words, 10¢ each  
additional word

# Crier Classifieds

Deadline:  
Monday 5 pm  
Call 453-6900

## Help Wanted

Nurses Aids, dietary aids, immediate openings. All shifts. No experience necessary. Farmington Nursing Home, 30405 Folsom Rd., 477-7400.

Immediate openings for directed study aides (Study Hall) and male boys locker room aide. Apply at the Plymouth-Canton Community Schools, 454 S. Harvey St.

NEED A JOB? Part time work for full time pay. Earn \$12 per hour. No collecting or delivery. \$400.00 wardrobe, no investment +45% discount. Over 21, car necessary. Will train, call 981-0431 or 477-4231.

IMMEDIATE opening for nurses aids on all three shifts. Apply in person, West Trail Nursing Home, 395 West Ann Arbor Trail.

ATTENTION: Merri-Mac needs supervisors & demonstrators to sell our guaranteed line of toys & gifts on home party plan. Compare our program! You'll see why Merri-Mac is the leader in the industry. Experienced dealers may qualify for FREE KIT & more!! Call collect now for details: Ann Baxter 319-556-8881 or write Merri-Mac, 801 Jackson, Dubuque, Iowa 52001.

Registered nurse full-time afternoon shift. Apply in person, West Trail Nursing Home, 395 W. Ann Arbor Trail.

Licensed Practical Nurse. Afternoon shift, full-time. Apply in person, West Trail Nursing Home, 395 W. Ann Arbor Trail.

The U.S. Post Office in Plymouth announces that it will accept applications for clerk/carrier examination during the period March 3rd thru March 10th. Applications available at window.

### CAN'T WORK 9 TO 5?

Sell Avon and you can choose your own hours. Earn good money and meet interesting people, too. For details, call 291-7862.

Hair Dresser wanted for full service unisex salon in Livonia, at least one year experience, 478-8180.

Plymouth resident with flexible schedule, part-time to manage, rent, and keep up repairs on rental properties. Excellent for retirees, 661-1360.

Help Wanted: Evening manager (restaurant and convenience store). Apply in person: 8:30 a.m.-3:30 p.m. Cloverdale Farms Dairy, 447 Forest.

PRACTICING HAIRSTYLIST. D.D. Hair Fashions in Canton now interviewing for full & part time, male & female stylists with Redkin & R.K. training. We offer full time, year round excellent pay, Blue Cross & good hours. Call manager for interview 453-6540 or 453-0878.

Cafeteria worker part-time, 11 a.m. to 4 p.m. Monday through Friday. Call 455-1480. Equal Opportunity Employer.

## Situations

Will babysit, my home, experienced, dependable, Canton, 981-1017.

## Wanted to Buy

WANTED: File Cabinets. Will pay hard cash. Call Chas, 453-6900.

## Articles for Sale

Singer style-o-matic sewing machine - excellent condition; in cabinet, \$85.00; 56" gold love seat, good condition, \$85.00, call 453-7879.

## Firewood

Hickory, birch, apple, oak, or slabs. Delivered, dumped, or stacked \$36.00 and up for a big pick-up truck full. Wood-coal stove for sale, 349-3018, 453-0994.

## Vehicles for Sale

'72 Ford pick up, 3/4 ton, air, pb, ps, \$1300 after 3 p.m., 455-2708.

1978 LTD four-door 400 engine D-8, air conditioner, power-steering and brakes, vinyl roof, radio, recliner seat, 9200 miles, 453-0175.

1977 Firebird - esprit, 301, T top, air, AM-FM, 8 tract, 23,000 miles, \$4500 453-0612 after 4 p.m.

'73 Dart Swinger, 318, new tires, P.S., P.B., air, \$950. 455-4716.

1977 Oldsmobile Starfire GT. V-6, 5 speed, PS, PB, AM-FM Stereo, rear defog, front and rear stabilizers, gauge package, styled wheels, \$3,400, phone 453-0334 evenings, 453-6900 days.

## For Rent

VFW HALL for rent - weddings, graduations and parties, 455-8950.

## Services

Hi Quality upholstery done in my home. 25 years experience. Specializing in hidabeds and recliners, large selection of fabrics. Call 348-3577.

ID cards, full color, while you wait. Phone 453-6033.

Chair-caning - rush work: we do or teach you Studio of Ellice, 459-1892.

FREE PREGNANCY TESTS, safe, legal abortion, immediate appointments. Helping women since 1972. Women's Center, 476-2772.

Big Happy Hank the Clown: birthdays or big or small events, (1) Logan 3-0576.

Piano, organ, beginning-advanced. 20 years experience, Mr. Phillips - formerly with Anderson Music, 453-0108.

## Income Tax

Make sure you pay the lowest INCOME TAX. Experienced preparer, computer processing assures this, 459-5369.

Accountant, 17 years experience, will prepare tax returns in your home. Appointments, call 453-1698.

# Crier Routes

are still available  
in many areas.

Call

453-6900

for your Crier Route.

# Crier Classifieds

Reach the people  
in YOUR community

## Call: 453-6900

or clip & mail this form today!

Write Your Ad Here:

**10 Words- \$2.50**  
**Extra Words-**  
**10¢ each**  
**Deadline:**  
**5 pm Monday for**  
**Wednesday's Paper**

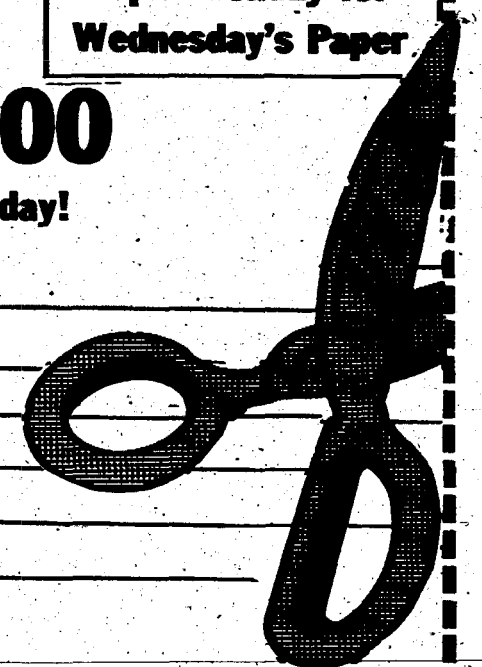

Mail to:  
**The Crier**  
**1226 S. Main St.**  
**Plymouth, Mi. 48170**

Your Name \_\_\_\_\_

Phone \_\_\_\_\_

Address \_\_\_\_\_

## service directory

<b>BINGO</b> EVERY SUNDAY - 6:30 p.m. K of C Hall, 39050 Schoolcraft (east of Eckles) 464-0500	<b>BINGO</b> Every Tuesday 6:45 p.m. Plymouth Moose Lodge New Redford Hall Inkster and Plymouth Rds.	<b>DO IT YOURSELF</b> AND SAVE \$\$\$\$! Everything you need for Bathroom & Kitchen remodeling. WE'LL SHOW YOU HOW! The Family Bath Boutique 875 Wing St. 459-1680
<b>ALTERATIONS</b> (Men's clothing and ladies tailored suits and slacks.) Regardless of where you purchased them - Satisfaction Guaranteed! <b>LENT'S CUSTOM CLOTHING</b> Plymouth 453-5260 Our own Tailor on premises.		<b>PIANO TUNING</b> Jim Alexander - 459-4646 Professional tuning, regulating & Repair. Call 5 p.m.
<b>BATHROOMS &amp; KITCHENS</b> Our Specialty Finished Basements. <b>H. MONTRY CONST.</b> Lic. No. 47276 (313) 453-6172 or (517) 546-4375	<b>PAINTING INTERIOR AND EXTERIOR</b> Ceiling & wall repair. FREE ESTIMATES. 721-5006 Daily 729-8547 after 5 or wknds. No job too small - phone NOW & SAVE	<b>FIREPLACES BY R. MONTRY CONST.</b> 28, 36, 42 inch. Zero clearance, draft pull from outside, need not pull warm room air for combustion. Glass doors, blowers, no footing or brickwork needed. Custom mantels, stone or brick front & hearth. Quick installation. We can build all winter. \$1900 & up. Lic. no. 47276
 <b>Plymouth Janitorial Service</b> Professional OFFICE CLEANING Hours at your convenience - References. Let our staff handle what you can't - don't have time to do. 453-8297	 <b>DAVE'S CARPET CLEANING</b> Carpet sales & service. Also furniture cleaning. 459-3090	<b>CRITER CLASSIFIEDS - THE PLACE TO BE!</b>  <b>(313) 453-6172</b> OR <b>(517) 546-4375</b>

\$2.50 for the first  
10 words, 10¢ each  
additional word

# Crier Classifieds

Deadline:  
Monday 5 pm  
Call 453-6900

## Land for Sale

80 acres of the worlds best deer hunting, 4 beaver dams, lots of white birch, several building sites. Bob Wideman, Broker, Box 33, Gladwin, MI 48624.

102 acres pick your own fruit farm, 20 acres cherries, 20 varieties of apples, also berries and asparagus, near Lake Huron. Bob Wideman, Broker, Box 33, Gladwin, MI 48624.

36 acres gently rolling land, well perk, pond at rear, private, good horse farm or tree farm. Amick Realty, 973-2424.

## Pets

Free: 2 white rabbits and hutch, pets, 453-1664.

Found kitten, male, black and gray, tabby striped, white chest & stomach. Gold-green eyes. Near Sheldon Rd. and Arther & Junction Streets. 455-4086. Keep calling.

FOUND - Full grown male beagle, mostly black. Forrest Brooke Village, south of Palmer between Sheldon & Lilley, 397-0746. Anyone can have him.

## Curiosities

Why does Colonial Foods offer stuffed cabbage . . . cause it's GOOD! Hot delivery, 459-5900.

Win a Las Vegas week-end for two, or other prizes in our Grand Opening Giveaway. Register now! No purchase necessary. Family Bath Boutique, 875 Wing St., 459-1680.

Thanks Alice, Fran and Ed for making my day special.

Phyllis

STEVE HERBRUCK is older now. Getting up there, eh? Cackle, cackle.

DON - sure glad you got your IRS refund back. Thanks for dinner.

JESSICA eats quiche; Tucker eats with Skippy.

HELP A NAKED lip today: lost one dark mustache in the vicinity of The Crier's production dept.

RANDY - sorry about that lamp.

PIANO MOVING strikes a sour note, Arnie. Hope you're happy with it where it is for many years to come.

NANCY, PAT, PHYLLIS, MIKE and BOB: didn't you know it was a costume party?

NOTHING VENTURED is gaining. Good luck on your expansion program. Pretty soon you'll be spreading out into Penniman Avenue.

Ronnie, don't give up piano lessons yet. "Minuet in G" is just around the corner.

## Curiosities

You may be in love with our Shearling jackets but at 30% off you'll really love them. Walter Dyer jackets on sale, too. Hands on Leather, Forest Place, 459-6560.

Hi Eric and Janet and Eric J., too. Mom and Dad

Extra pushups are piling up in your stretch and bend class, ladies. Get with it, Phyllis and Susie.

Shower with the one you like. All Ondine massage showers now 25% off with this ad. The Family Bath Boutique, 875 Wing St., Plymouth, 459-1680

## EYE CATCHERS

Misties, candlelights, environmentals, and so much more to add that special touch to your wedding photography. Rawlinson Photography, 453-8872.

BOB . . . My eyes were red, today changed to blue; Golly Gee you're home, "Have I got something for You!!!"  
Your Red Hot Mama

Edie: You're something special! Love ya, Davis.

Spring has sprung, the grass has ris, I wonder where the flowers is?

Bob Cee, Don't send the check, it was Phyllis.

**She walks!**  
(when she wants to)

### ADVERTISEMENT FOR BIDS

Sealed bids will be received for:  
GENERAL CONSTRUCTION OF:  
Plymouth Township Hall  
Addition and Renovations  
42350 Ann Arbor Road.  
Plymouth, Michigan

Bid Proposals will be received until the time and the place, as follows, where and when they will be publicly opened and read aloud:  
TIME: 4:00 p.m. E.S.T., Thursday, March 22, 1979

PLAC: Plymouth Township Offices, 42350 Ann Arbor Road, Plymouth, Michigan

Bidding Documents will be available for examination and distribution on or after March 1, 1979.

Examination may be made at: The Office of the Architect, Michael A. Boggio Associates, 28575 Greenfield Road, Southfield, Michigan; Plymouth Township Offices, 42350 Ann Arbor Road, Plymouth, Michigan; F. W. Dodge Corporation, Plan Room, Detroit, Michigan; or the Builders Exchange of Detroit and Michigan, Detroit, Michigan.

Qualified Bidders: upon payment of a \$50 deposit may obtain bidding documents

from the Office of the Architect or the Township Offices, consisting of two (2) sets of Drawing prints and two (2) sets of Specifications.

Deposits will be refunded upon return of the Bidding Documents to the Owner within ten (10) days after opening of proposals provided the documents are complete, in clean and usable condition and free of marks or other defacement.

Bid Proposals shall be on forms furnished with the Bidding Documents, accompanied by a satisfactory Bid Bond or Certified Check for five percent (5%) of the Base Bid Sum maximum possible proposal amount.

Bidder shall agree not to withdraw Bid Proposal for a period of thirty (30) days after date for receipt of bids.

Accepted Bidder shall be required to furnish satisfactory Performance Bond and Labor and Material Payment Bond in accordance with the Instructions to Bidders.

The right to reject any or all Bid Proposals, either in whole or in part, or to waive any informalities therein is reserved by the Owner.

Publish: Feb. 28, March 7, March 14, 1979.

### TOWNSHIP OF PLYMOUTH BOARD OF TRUSTEES - REGULAR MEETING TUESDAY, FEBRUARY 27, 1979

The meeting was called to order at 8:00 p.m. by Supervisor Notebaert, followed by the Pledge of Allegiance to the flag. All members were present.

It was moved by Fidge and supported by West that the minutes of the Special Meeting of February 10, 1979 be approved as submitted. Ayes all.

The Clerk asked that the line on Page 6 reading "The Supervisor called for the vote on the motion amended. Ayes all." be moved up 8 lines on the page. Fidge asked that in line 5, page 2, that "Bailey" be substituted for "Morgan"; line 33, same page - "areas" rather than "area" line 23, page 3 read "provided that no extra compensation be authorized as a result of his attendance at the school for any member of the fire department."

With the above corrections Fidge moved that the minutes of the February 13, 1979 meeting be accepted as correct. Supported by Lynch. Ayes all.

Moved by West and supported by Hulsing that the payment of bills in the grand total of \$87,870.74 be allowed. Ayes: Notebaert, West, Breen, Law and Lynch. Fidge abstained because of the Brender-Hamill bill placement.

The clerk asked that the request of the Fire Chief for a closed meeting to discuss a few matters of importance in the area of labor problems, be placed on the Agenda.

It was moved by West and supported by Lynch to consider the Fire Chief's request at the end of the meeting. Ayes all.

It was moved by Breen and supported by Law that the total amount of the E.P.10 funds in the amount of \$98,775 be used to begin a shelter abuse program. Ayes: Breen, Law, Naves: Lynch, Fidge, West, Hulsing, Notebaert.

Fidge moved to table the item. West supported. Ayes all.

Law moved that we entertain bids for security and fire alarms systems for the Hilltop Golf Club Building and those on the Recreation Site simultaneously but separately. Breen supported the motion. Ayes all.

It was moved by Lynch and supported by Fidge that Bailey set up specifications for a burglar alarm system with a silent alarm to be hooked up to the Sheriff's Department with a fire detection system worked out jointly. Ayes all.

Lynch moved we reject the request of the sergeants for additional payment in-as much as we have already given a gift for work performed. Supported by Fidge. Ayes all.

It was moved by Breen and supported by Lynch that the "best offer" received for the Teledyne old air conditioners following public advertising be accepted. Ayes all.

It was moved by West and supported by Breen that the following special meetings for the budget be established: March 5, 1979 with Mr. Hollis, March 6, 1979 with Mr. Groth, and March 8, 1979 with Mr. Briggs. All meetings are to begin at 7:30 p.m. Ayes all.

Law moved that the Township Attorney and/or any other attorney deemed acceptable by Township Board members be authorized to represent Township Board members individually or collectively in any lawsuits for acts arising while engaged in the exercise or discharge of a governmental function on behalf of Plymouth Township and that all attorney costs be paid by Plymouth Township. Seconded by Hulsing. Ayes all.

It was moved by West and supported by Lynch that we adopt a fiscal year ordinance setting the fiscal year of April 1 - March 31 as suggested by the attorney to be signed by the Clerk. Ayes all.

A copy of Ordinance is attached to the official minutes. On a roll call vote all voted aye.

There was no objection to the Supervisor directing that the item on insurance coverage for public officials errors and omissions be put over to such time as we are on this subject in budget time.

It was moved by Breen, supported by Fidge that we authorize renewal of the policies of the Public Employee Blanket Bond and money and securities coverage at their old limits. Ayes: Lynch, Law, Breen, Notebaert, Fidge. Naves: West and Hulsing.

It was moved by Breen and supported by West that the State Highway Department be granted a permit in accord with their letter of February 23, 1979 to execute and refill according to plan; erect fences or barriers and such other safety features as necessary; return site to grade or to a grade as required by the Township Engineers (either Dietrich or Bailey as is pertinent). Ayes all.

It was moved by West; supported by Fidge that we deny Mr. Gould's request for the cancellation of the performance bond for Lift Station, Beacon Estates Subdivision No. 4 until the sewers are installed. Ayes all.

Fidge went over in detail the Public Act. No. 267 of 1976. A copy of the parts of the Act that

specifically deal with the necessary notices and their content of both open and closed meetings, the restrictions on closed meeting, etc. are appended to these minutes. It was stressed that procedures in the law must be followed.

The Supervisor directed that the topic of Site Analysis of the Township Hall be tabled for study and review during the meeting of March 13, 1979.

Breen moved that the meeting on the 13th of March begin at 7:30 p.m. and that the Site Analysis be the first item under old business. Supported by Lynch. Ayes all.

Breen moved that we authorize the engineer to prepare the necessary change orders to eliminate the septic disposal tank from the New Service Building. Supported by West. Ayes: Lynch, Breen, Fidge, Hulsing, West, Notebaert. Naves: Law.

It was moved by West and supported by Hulsing that the completion time for the Watermain Replacement on Sheldon Road be extended to May as recommended by the Engineer. Ayes all.

It was moved by Breen and supported by West that the request for the extension of time for completion of the Plymouth Township Recreation Building be approved. Ayes all.

Moved by Hulsing, supported by Fidge that the request for extension of time for the completion of the irrigation system - Hilltop Golf Course be granted.

It was moved by West, supported by Hulsing that we approved the splitting of two lots to be added to the Church of Nazarine property - Application No. 446. Ayes all.

It was moved by Hulsing, supported by West that the Final Preliminary Plat of Plymouth Crossing Subdivision be approved. Ayes all.

Moved by Breen, supported by Fidge that we secure a report from Bailey with a recommendation as to what will be necessary to prevent ponding in the area. Ayes all.

It was moved by West and supported by Breen that \$2,302.55 be transferred from the General Fund into the ARFA Account and clear it out. Ayes all.

Moved by West, supported by Fidge that the Resolution requested by Mr. Law asking that Hines Parkway be temporarily closed to motorized traffic on May 12, June 9, September 8th, and October 13th be passed. Ayes all. (copy of resolution is attached to the official minutes)

S.E.M.T.A. asked that a parcel of excess land located on Ann Arbor Road adjacent to Eckles along the Expressway be reserved for them for a Park and Ride Site.

It was moved by West and supported by Breen that we deny support to the S.E.M.T.A. request for "Park and Ride Site" Ayes all.

It was the contention of the Trustees that the Board had asked that the Township have "first refusal" of any property the Michigan State Department of Transportation declared surplus along the right-of-ways of the expressways crossing the Township. The Supervisor was asked to reaffirm with the Michigan State Department of Transportation our desire to reserve open land for persons in subdivisions.

Moved by Breen, supported by Law that we concur with the resolution of the City of Trenton, re: Tax Incentive under Act 78 and therefore, change the wording where appropriate and forward to our members of the State Legislature and the Governor. Ayes all. Resolution attached to the official minutes.

Moved by Lynch, supported by Breen that Architect Boggio be added to the Agenda. Ayes all.

It was moved by Breen, supported by Fidge that we authorize the architect to submit the bill for prints and contracts as per his quote and upon submission of proper invoices they will be paid. Ayes all.

Moved by Breen, supported by West to move approval of the specifications and plans as submitted by the architect and authorize going out for bids as proposed by Mr. Boggio. Ayes all.

Moved by Hulsing and supported by Breen to add to the agenda a letter from Groth relative to the difficulty experienced in heating the new quarters in the Teledyne Building. Ayes all. Furnaces need further checking and additional floor heaters provided.

Groth had asked for a closed meeting to discuss the "Personnel Policies and Procedures" as they related to the old "Rules and Regulations of the Fire Department" The old "Rules and Regulations" had been adopted in 1968 and never rescinded. He was assured that where there was any conflict the "Personnel Policies and Procedures" took precedence. Groth asked for a grace period of 30 days during which he could sift through the old "Rules and Regulations" to determine which were operating procedures, and which were more properly Personnel Policies and Procedures.

At 12:20 a.m. Fidge moved and West supported the motion that the meeting adjourn. Ayes all.  
Approved,  
THOMAS NOTEBAERT, SUPERVISOR  
Respectfully submitted,  
ESTHER HULSING, CLERK

These minutes are synopsis - Official Minutes are on file in the Township Clerk's Office.



# Dial-It Shopping

## Alarms

**MIDWEST ELECTRONIC SECURITY**  
36343 Ford Rd.  
Westland  
721-3894

Wireless, Portable, Alarms for Apts., Homes, Office or Mobile Homes \* Radar Detectors \* Do it yourself - or we install!

## Auto Repair

**DENNY'S SERVICE**  
1008 Starkweather  
Plymouth  
453-8115

Front end work \* tune ups \* general repair. Master Mechanics certified by St. of Mich. \* Towing.

## Bakery

**MARIA'S ITALIAN BAKERY**  
115 Haggerty - 981-1200  
38411 Joy Rd. - 455-0780  
\* Square Pizza \* Hot Italian Bread \* Sausage \* Baked Goods \* Cannoles \* Cakes \* Italian Lunch Meat \* Beer \* Wine.

## Bookstore

**PLYMOUTH BOOK WORLD**  
2 Forest Place Mall  
Plymouth  
455-8787

Children Books, Cards, Gifts. For discriminating readers we now have a selective magazine corner.

## Bowling

**CANTON BOWLING & TROPHY SALES**  
45480 Ford Rd.  
Canton  
459-5530

Expert Fitting & Drilling - Complete line of quality equipment - Extensive trophy selection - Engraving - Youth program.

## Camera Shop

**POSITIVE OUTLOOK**  
5826 N. Sheldon Rd.  
Canton  
453-8810

Full time camera & photographic studio offering wedding photography & instant passports, \$4.99 with ad.

## Carpet

**DAVE'S CARPET CLEANING**  
640 Starkweather  
Plymouth  
459-3090

\*SALES-Lee's-Bigelow - Cranbrook \*CLEANING-Dry Foam Shampoo \*REPAIRS \*INSTALLATION-Professional service on all carpet.

## Catering & Beef

**PENNIMAN MARKET**  
820 Penniman Ave.  
453-3570

Hot or Cold Catering for all occasions - Prime Freezer Meat - any quantity.

## Chimney Sweep

**FLASH!** A chimney fire can ruin your whole day. For fire prevention and fuel efficiency, call **PAUL GLASS CHIMNEY SWEEPS**, 525-5418.

## Dance Instr.

**MICKIE'S DANCE COMPANY**  
7329 Lilley Rd. (at Warren)  
Canton, MI (Kings Row)  
459-1760, 427-4873

All Types of Dance Available. Mickie Gaffke - B.S. Dance & Drama, Director - D.M.M., Member - D.M.A., M.D.A., D.M.D.P.

## Dog Grooming

**JEAN VOLLICK**  
11375 W. Clements Cr.  
Livonia  
427-1592

Professional Dog Grooming. Purebred to Heinz 57, Special Attention to Each Pet.

## Electrician

**SAMSANOW ELECTRIC**  
195 S. Mill  
455-1166

Complete electrical service. Commercial & Residential \* Industrial. Electric Heating, electrical code violations corrected. Electrical repairs.

## Fire Wood

**GREEN GIANT LANDSCAPING**  
46645 W. Ann Arbor Trail  
Plymouth  
455-9499

Birch and Hardwood. Also equipped for road clearing & grading. Commercial snow removal. Topsoil & Fill Sand.

## Floorcovering

**FLOOR FASHIONS OF CANTON**  
5854 Sheldon Rd.  
Harvard Square Shopping Ctr.  
459-6180, 453-7777

Complete Decorating Center: Carpet \* Tile \* Vinyl & Wood Floors \* Paint \* Wallcovering \* Draperies \* Wovenwoods \* Shades \* Levelor's \* Shutters.

## Florist

**HEIDE'S FLOWERS**  
Ann Arbor Trail at Harvey  
453-5140

Largest selection of Fresh, Dried & Silk Flowers. Also featuring Wicker, Stuffed Animals, Brass & Pottery. Daily Deliveries.

## Furniture

**LAUREL FURNITURE**  
Complete home furnishings. Large selection of baby furniture and clocks. Quality furniture moderately priced. Free delivery.  
584 W. Ann Arbor Tr.  
Plymouth  
453-4700

## Furniture Refin.

**FURNITURE REJUVENATION UNLIMITED**  
882 Holbrook  
Old Village - Plymouth  
459-4930  
Natural & Painted Finishes  
Wood Repair - Woven Seats  
Hand Stripping  
Wicker Repair

## Hair Cutting

**BEAUTIFUL PEOPLE**  
450 Forest  
Plymouth  
459-2880

Professional Hair Care is present today wherever fashionable American women & men go -

## Hardware

**S & W HARDWARE**  
875 Ann Arbor Rd.  
Plymouth  
453-1290

Complete plumbing & electrical supplies. Builders hardware. Paint, lawn, garden supplies. Do it yourself headquarters.

## Hobby

**PLYMOUTH HOBBY**  
22 Forest Place  
Plymouth  
453-1997

Slot car sets, \$19.79 up; Train Sets, \$19.78 up; Lionel Sets and Supplies; Models, plastic, wood, metal.

## Insulation

**AIR TITE INSULATION**  
882 N. Holbrook  
Plymouth  
453-0250

Save on the cost of heating - cooling. Fast, professional installation - "your comfort is our business."

## Linen & Gifts

**BED N STEAD**  
6 Forest Place  
455-7494, 455-7380

Featuring linens for beds, tables, and bath. Candles \* Scandinavian Imports \* Handcrafted Gifts \* Unusual Christmas Ornaments.

## Office Supplies

**PLYMOUTH OFFICE SUPPLY**  
840 W. Ann Arbor Trail  
453-3590

Desks & Accessories \* Chairs \* Files \* Rubber Stamps \* Attaches \* Dated Diaries \* 3M Copy Paper \* Free Delivery.

## Photographer

**RAWLINSON PHOTOGRAPHY**  
453-8872

Specializing in location photography such as weddings, anniversaries, environmental portraits, teams, senior portraits and others.

## Pizzeria

**BEE JAY'S KITCHEN**  
628 S. Main  
Plymouth  
455-8010

Take Out and Fast Delivery: Very Best Pizza, Ribs, Fish, Shrimp, Chicken, Spaghetti and Scallops.

## Plumbing

**JOHN J. CUMMING PLUMBING**  
1425 Goldsmith  
Plymouth  
453-4622

Kohler plumbing fixtures. Residential \* Commercial \* Repairs \* Modernization \* Rheem water heaters.

## Pottery

**POTTER'S WHEEL**  
689 N. Mill Old Village  
Plymouth  
459-9890

Pottery & Classes  
A Unique producing studio \* Gallery \* Day \* Evening Classes \* Special Orders accepted \* Original - Electrical and Oil Lamps.

## Real Estate

**REALTY WORLD**  
Wm. Decker, Inc.  
670 S. Main, Plymouth  
455-8400

Your good will is our greatest asset, we are therefore PLEDGED to your service.

## Travel Agency

**HARVARD SQUARE TRAVEL**  
Sheldon Rd. & Ford Rd.  
in Harvard Sq. Mall  
459-2010

Full Service Agency: Airline Tickets, Cruises, Charters, Custom Itineraries, Commercial Accounts. Mon.-Fri. 9:30 a.m. - 5:30 p.m., Sat. 10 - 2.

## Vacuum Cleaners

**AUSTIN VACUUM**  
696 N. Mill  
Plymouth  
453-0415

Sales & Service of Vacuums & Sewing Machines. All makes & models. Small appliance repair. Mon. thru Sat. 9-6, Fri. 9-9.

## Wallpaper & Fabric

**JUST ANN'S**  
746 Starkweather  
Plymouth  
459-5444

Largest selection of decorator wall coverings & fabric in area. Drapery, upholstery services. 9:30 - 5 Mon. thru Sat. or by appointment.

## Wicker

**WICKER WAREHOUSE & WOODCRAFT**  
689 N. Mill St.  
Plymouth  
459-2990

Headboards \* Tables \* Mirrors  
Tablelamps \* Buri Etageres \* Unique and Different Baskets \* Call about Our "Wicker Parties."

## Window Treatment

**INTERIOR REFLECTION**  
5948 Sheldon  
Harvard Sq. Shopping Center  
Canton  
459-0100

Window treatments \* Wallcoverings \* Accessories \* Advice - a great background for your interior environment. Shpp at home.

## Wood Stoves

**WOODEN HEAT STOVE WORKS**  
744 Starkweather  
Plymouth  
459-0920

Furnace Add Ons \* Wood Heaters \* Fireplace Conversion \* "Free Heat Machine" \* All-Fuel Chimneys \* Heat Reclaimers \* Accessories.

**CALL NOW TO RESERVE SPACE IN THE CRIER'S NEW DIAL-IT SHOPPING GUIDE STARTING APRIL 4th. 453-6900**



# BOLENS Pre-Season SALE

## The Original Bolens Mulching Mower

The first mulching mower was a Bolens. Now with thousands of satisfied owners, Bolens is still first in Mulching Mowers, with features and prices UNMATCHED by the imitators

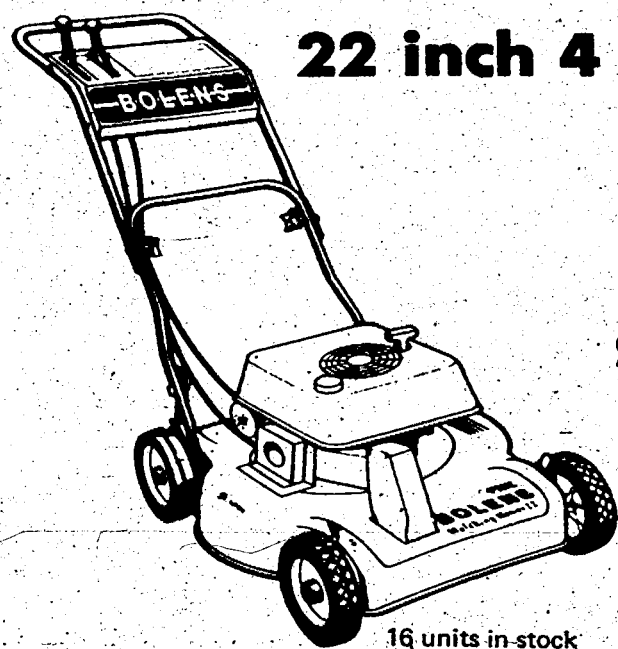

**22 inch 4 horsepower**  
Self-Propelled  
**BOLENS**  
Mulching Mower

**\$275<sup>00</sup>**

Reg. \$315.00

16 units in stock

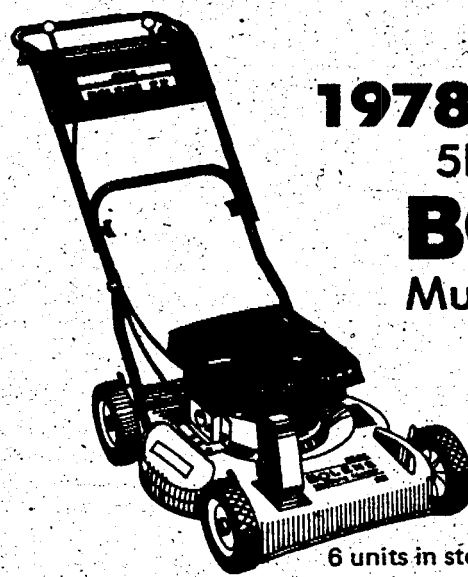

**1978 Close - Out**  
5H.P. 22 inch  
**BOLENS**  
Mulching Mower

**\$279<sup>95</sup>**

Reg. \$309.95

6 units in stock

## Bolens Lawn & Garden TRACTOR

with 54 inch Rotary Mower

Pre-Season Price **\$3995<sup>00</sup>**

Reg. \$5000.50

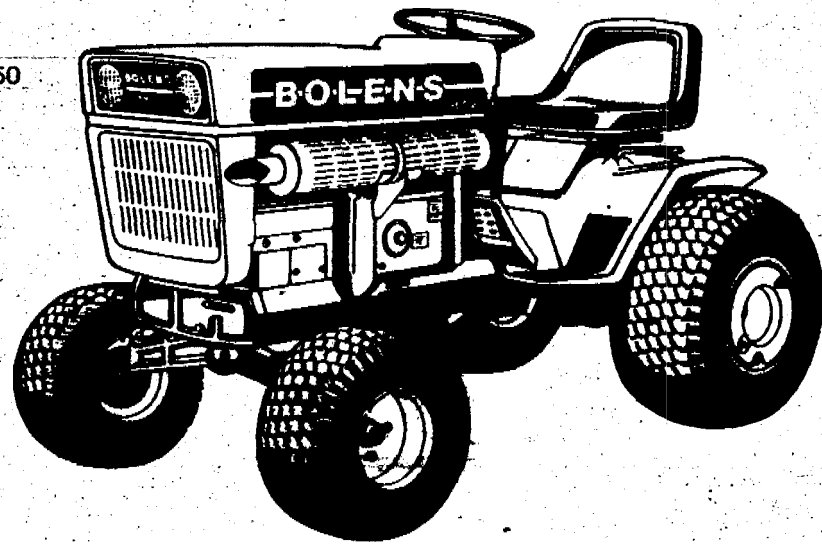

2 units  
in stock

## Bolens 8HP 30" Cut Rear Engine RIDING MOWER

with heavy duty frame,  
floating deck to  
follow lawn contours  
5 cutting heights.

Pre-Season Price  
**\$875<sup>00</sup>**

Reg. \$975.00

2 units in stock



## Rear Hopper / Bagger Kit

Pre-Season when  
purchased with mower **\$47<sup>95</sup>**  
Reg. \$95.85

# SAXTONS GARDEN center inc.

Everything for the garden but the rain

**587 W. ANN ARBOR TRAIL  
PLYMOUTH • 453-6250**

Hours: Daily 9-6  
Fri. 9-8 Sat. 9-5